

Ecological site R006XB013OR Wet Pumice Meadow 14-26 PZ

Accessed: 02/09/2025

General information

Provisional. A provisional ecological site description has undergone quality control and quality assurance review. It contains a working state and transition model and enough information to identify the ecological site.

Associated sites

R006XB011OR	Meadow Knoll 14-26 PZ
R006XB012OR	Dry Pumice Meadow 14-26 PZ This site occurs in open, marshy areas usually surrounded by Lodgepole and/or Ponderosa pine forestlands. It may occupy large homogenous areas or will be in complexes of Dry Pumice Meadow, Meadow Swale, Marshy Swale, and Meadow Knoll. These complexes are often difficult to separate; changes in sites is gradual and there may be only slight micro relief between sites.
R006XB014OR	Meadow Swale 14-26 PZ
R006XB015OR	Marshy Swale 14-26 PZ

Similar sites

R006XB012OR	Dry Pumice Meadow 14-26 PZ The site is similar to Dry Pumice Meadow but has a higher water table (in the root zone of the grasses- within 36 inches) for a longer time during the period of rapid growth. There are similarities in plant community and hydrology to Tufted Hairgrass Prairies that are found infrequently in the Willamette Valley area (MLRA A2) of Oregon.
-------------	---

Table 1. Dominant plant species

Tree	Not specified
Shrub	Not specified
Herbaceous	Not specified

Physiographic features

Table 2. Representative physiographic features

Landforms	(1) Alluvial fan
Ponding duration	Long (7 to 30 days) to very long (more than 30 days)
Ponding frequency	Frequent
Elevation	4,000–6,000 ft
Slope	0–1%
Ponding depth	3–6 in
Water table depth	0–60 in
Aspect	Aspect is not a significant factor

Climatic features

This site is characterized by relatively short, hot summers and cold, snowy winters. The site receives approximately 20 inches of precipitation per year, the bulk of which is snowfall. There are frequent thunderstorms in the summer months. There may be ground fogs in the morning during the growing season which affect stomatal gas exchange and photosynthetic activity.

Table 3. Representative climatic features

Frost-free period (average)	20 days
Freeze-free period (average)	49 days
Precipitation total (average)	25 in

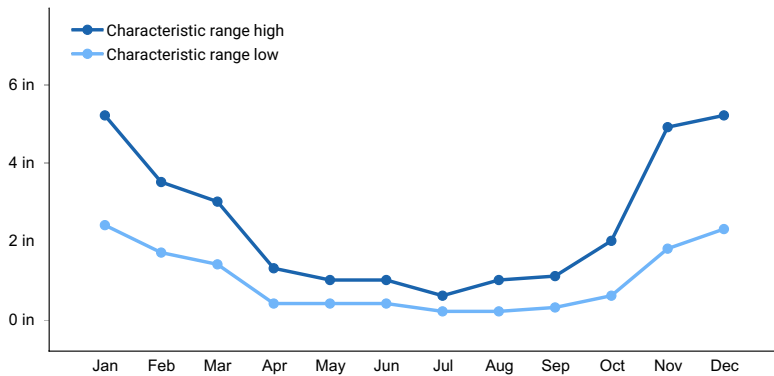

Figure 1. Monthly precipitation range

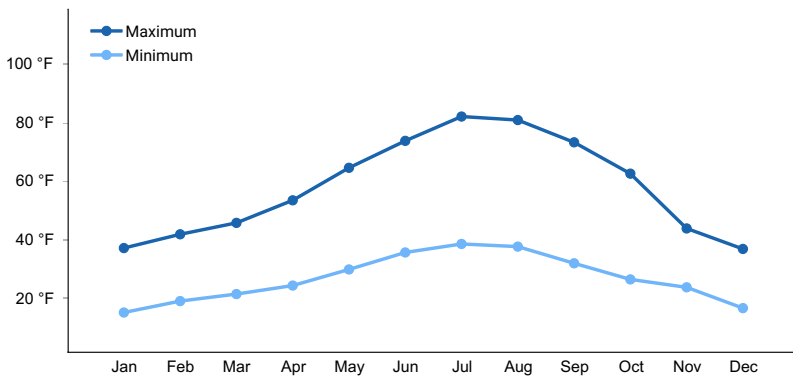

Figure 2. Monthly average minimum and maximum temperature

Influencing water features

None (usually adjacent to seasonally ponded wetlands and marshes).

Soil features

Soils for this site typically have a thin organic layer over loams, layers of coarse pumice over heavy clay loams. There is an apparent water table present for most of the year. These relatively young soils have been deposited over older, remnant fans and terraces. Variations and intergrades of soil characteristics are common.

Table 4. Representative soil features

Surface texture	(1) Mucky silt loam
Family particle size	(1) Loamy
Drainage class	Poorly drained
Permeability class	Moderately slow to rapid

Soil depth	60–150 in
Surface fragment cover <=3"	2%
Surface fragment cover >3"	2%
Available water capacity (0-40in)	4–7 in
Calcium carbonate equivalent (0-40in)	5%
Electrical conductivity (0-40in)	0–2 mmhos/cm
Sodium adsorption ratio (0-40in)	1–0
Soil reaction (1:1 water) (0-40in)	5
Subsurface fragment volume <=3" (Depth not specified)	2%
Subsurface fragment volume >3" (Depth not specified)	2%

Ecological dynamics

This site occurs on alluvial fans leading to deeper and lower marshy sites. It is intermediate between these wetter sites and adjacent Dry Pumice Meadow and Ponderosa Pine forest sites. The water table is apparently below the effective rooting depth for the grass species present for a portion of the growing season (depth to water table during the period of rapid growth appears to have a significant influence on the plant community). The water table (during the early portion of the growing season) lowers at a slower rate than the Dry Pumice Meadow site. Wet Pumice Meadows are occasionally ponded wetlands within larger complexes of wetland sites. The interpretative plant community for this site is the Historic Climax Plant Community (HCPC).

State and transition model

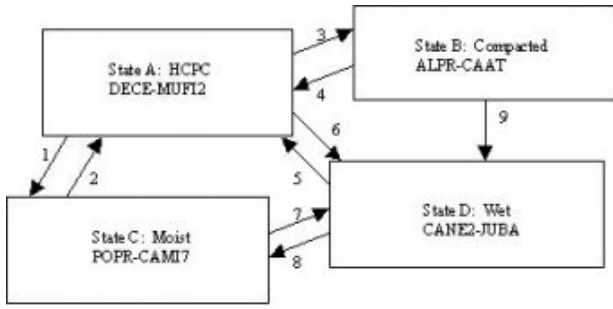

Figure 3. Wet Pumice Meadow State and Transition Model:

State 1
HCPC: DECE- MUF12

Community 1.1
HCPC: DECE- MUF12

This site is characterized by the abundance of Tufted Hairgrass and Pull-Up Muhly (the annual Muhly takes advantage of the more rapidly drying soil surface of this relatively wet site). Slender Cinquefoil (POGR9) may also be a significant component of this site.

Table 5. Annual production by plant type

Plant Type	Low (Lb/Acre)	Representative Value (Lb/Acre)	High (Lb/Acre)
Grass/Grasslike	2700	3350	4400
Forb	250	300	350
Tree	45	63	80
Total	2995	3713	4830

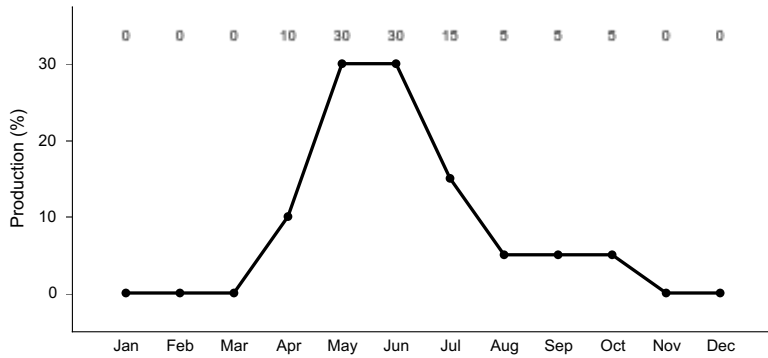

Figure 5. Plant community growth curve (percent production by month). OR1881, B6 Wet Pumice Meadow RPC. (DECD-MUFI2) B6 Wet Pumice Meadow RPC.

State 2

State B: ALPR-CAAT

Community 2.1

State B: ALPR-CAAT

This site is dominated with a heavy and dense stand of Meadow Foxtail and Slenderbeaked Sedge. Past use by grazing animals and an increase in the influence of the water table through irrigation, combined with the introduction of the Meadow Foxtail formed this mildly compacted steady state.

Table 6. Annual production by plant type

Plant Type	Low (Lb/Acre)	Representative Value (Lb/Acre)	High (Lb/Acre)
Grass/Grasslike	6200	7100	8000
Forb	450	625	800
Total	6650	7725	8800

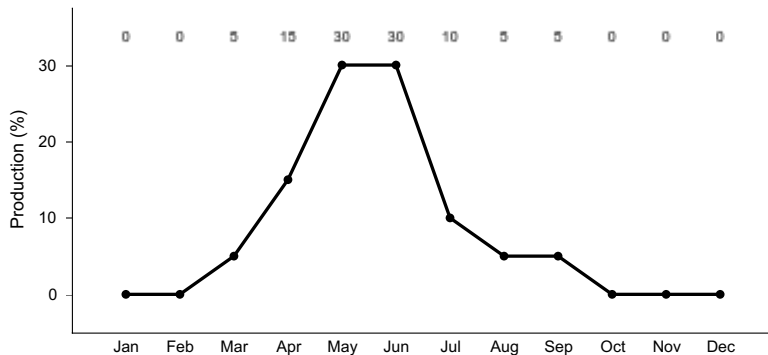

Figure 7. Plant community growth curve (percent production by month). OR1882, B6 Wet Pumice Meadow B. Disturbance/ Compacted (ALPR-CAAT).

State 3

State C: POPR-CAMI7

Community 3.1

State C: POPR-CAMI7

This site, dominated with Kentucky Bluegrass and Small-winged Sedge may be the result of introduction of Kentucky Bluegrass, past grazing practices, and additional surface and sub-surface water from irrigation or drainage water from other sites.

Table 7. Annual production by plant type

Plant Type	Low (Lb/Acre)	Representative Value (Lb/Acre)	High (Lb/Acre)
Grass/Grasslike	3000	3500	4000
Forb	325	388	450
Shrub/Vine	75	113	175
Total	3400	4001	4625

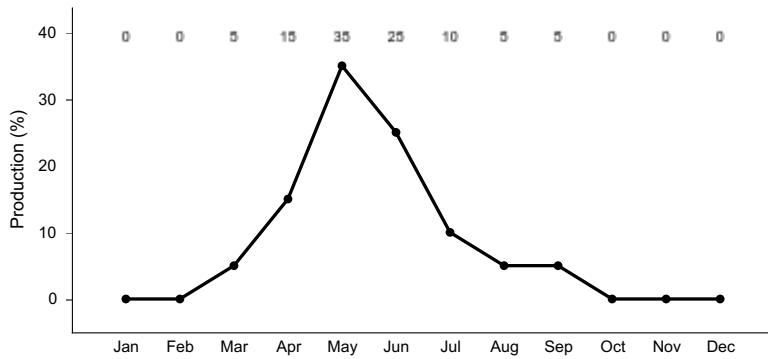

Figure 9. Plant community growth curve (percent production by month). OR1883, B6 Wet Pumice Meadow C. Disturbance/Moist (POPR-JUOR) .

State 4
State D: CANE2-JUBA

Community 4.1
State D: CANE2-JUBA

The wettest state of this site is dominated by Nebraska Sedge and Baltic Rush. This state has been the most disturbed by grazing pressure and a significant increase of surface and sub-surface water.

Table 8. Annual production by plant type

Plant Type	Low (Lb/Acre)	Representative Value (Lb/Acre)	High (Lb/Acre)
Grass/Grasslike	2300	2900	3500
Forb	275	388	500
Total	2575	3288	4000

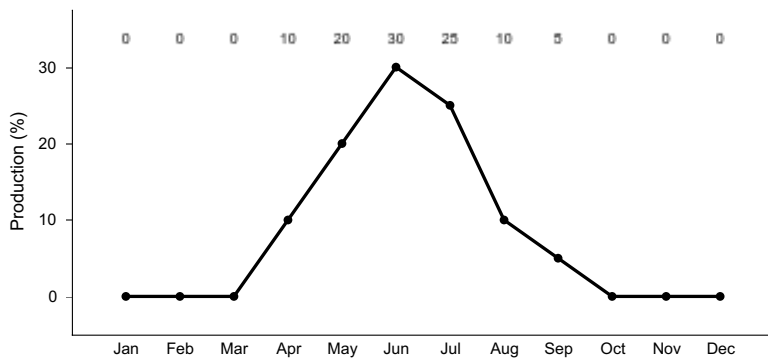

Figure 11. Plant community growth curve (percent production by month). OR1884, B6 Wet Pumice Meadow D. Disturbance/ Wet (CANE2-JUBA).

Additional community tables

Table 9. Community 1.1 plant community composition

Group	Common Name	Symbol	Scientific Name	Annual Production (Lb/Acre)	Foliar Cover (%)
Grass/Grasslike					
1				1949–2508	
	Sandberg bluegrass	POSE	<i>Poa secunda</i>	189–308	–
2				409–748	
	pullup muhly	MUF12	<i>Muhlenbergia filiformis</i>	220–440	–
	meadow barley	HOBR2	<i>Hordeum brachyantherum</i>	189–308	–
3				818–1496	
	Nebraska sedge	CANE2	<i>Carex nebrascensis</i>	220–440	–
	analogue sedge	CAS12	<i>Carex simulata</i>	220–440	–
	slenderbeak sedge	CAAT3	<i>Carex athrostachya</i>	189–308	–
	smallwing sedge	CAM17	<i>Carex microptera</i>	189–308	–
4				409–616	
	Sierra rush	JUNE	<i>Juncus nevadensis</i>	189–308	–
Forb					
5				132–176	
	Chamisso arnica	ARCH14	<i>Arnica chamissonis ssp. foliosa var. incana</i>	132–176	–
6				8–132	
	small camas	CAQU2	<i>Camassia quamash</i>	8–132	–
	fleabane	ERIGE2	<i>Erigeron</i>	8–132	–
	Virginia strawberry	FRVI	<i>Fragaria virginiana</i>	8–132	–
	American bistort	POBI6	<i>Polygonum bistortoides</i>	8–132	–
	slender cinquefoil	POGR9	<i>Potentilla gracilis</i>	8–132	–
	buttercup	RANUN	<i>Ranunculus</i>	8–132	–
	hooded lady's tresses	SPRO	<i>Spiranthes romanzoffiana</i>	8–132	–
	western mountain aster	SYSPS	<i>Symphotrichum spathulatum var. spathulatum</i>	8–132	–
Tree					
7				45–80	
	greenleaf willow	SALUC	<i>Salix lucida ssp. caudata</i>	44–88	–

Table 10. Community 2.1 plant community composition

Group	Common Name	Symbol	Scientific Name	Annual Production (Lb/Acre)	Foliar Cover (%)
Grass/Grasslike					
1				124–450	
	Sandberg bluegrass	POSE	<i>Poa secunda</i>	124–180	–
2				4984–6390	
	meadow foxtail	ALPR3	<i>Alopecurus pratensis</i>	4500–5400	–
	timothy	PHPR3	<i>Phleum pratense</i>	180–450	–
	Kentucky bluegrass	POPR	<i>Poa pratensis</i>	180–360	–
	meadow barley	HOBR2	<i>Hordeum brachyantherum</i>	124–180	–
3				1024–1530	
	slenderbeak sedge	CAAT3	<i>Carex athrostachya</i>	900–1350	–
	Nebraska sedge	CANE2	<i>Carex nebrascensis</i>	124–180	–
4				124–180	
Forb					
5				270–450	
	slender cinquefoil	POGRB	<i>Potentilla gracilis var. brunnescens</i>	270–450	–
6				9–450	
	Chamisso arnica	ARCHI4	<i>Arnica chamissonis ssp. foliosa var. incana</i>	9–180	–
	fleabane	ERIGE2	<i>Erigeron</i>	9–180	–
	Virginia strawberry	FRVI	<i>Fragaria virginiana</i>	9–180	–
	buttercup	RANUN	<i>Ranunculus</i>	9–180	–
	western mountain aster	SYSPS	<i>Symphyotrichum spathulatum var. spathulatum</i>	9–180	–

Table 11. Community 3.1 plant community composition

Group	Common Name	Symbol	Scientific Name	Annual Production (Lb/Acre)	Foliar Cover (%)
Grass/Grasslike					
1				690–1150	
	smallwing sedge	CAMI7	<i>Carex microptera</i>	460–690	–
	clustered field sedge	CAPR5	<i>Carex praegracilis</i>	230–460	–
2				60–138	
	Kentucky bluegrass	POPR	<i>Poa pratensis</i>	1150–2300	–
	pullup muhly	MUF12	<i>Muhlenbergia filiformis</i>	46–230	–
	Cusick's bluegrass	POCU3	<i>Poa cusickii</i>	60–92	–
	meadow barley	HOBR2	<i>Hordeum brachyantherum</i>	60–92	–
	Sandberg bluegrass	POSE	<i>Poa secunda</i>	60–92	–
3				46–230	
	onespike danthonia	DAUN	<i>Danthonia unispicata</i>	46–230	–
4				60–92	
Forb					
5				230–368	
	slender cinquefoil	POGRB	<i>Potentilla gracilis var. brunnescens</i>	138–230	–
	pussytoes	ANTEN	<i>Antennaria</i>	92–138	–
6				7–184	
	common yarrow	ACMI2	<i>Achillea millefolium</i>	7–92	–
	agoseris	AGOSE	<i>Agoseris</i>	7–92	–
	aster	ASTER	<i>Aster</i>	7–92	–
	fleabane	ERIGE2	<i>Erigeron</i>	7–92	–
	falsegold groundsel	PAPSP2	<i>Packera pseud aurea var. pseud aurea</i>	7–92	–
	western dock	RUAQ	<i>Rumex aquaticus</i>	7–92	–
Shrub/Vine					
7				75–150	
	silver sagebrush	ARCA13	<i>Artemisia cana</i>	92–184	–

Table 12. Community 4.1 plant community composition

Group	Common Name	Symbol	Scientific Name	Annual Production (Lb/Acre)	Foliar Cover (%)
Grass/Grasslike					
1				600–1000	
2				276–480	
	American sloughgrass	BESY	<i>Beckmannia syzigachne</i>	69–120	–
	meadow barley	HOBR2	<i>Hordeum brachyantherum</i>	69–120	–
	prairie Junegrass	KOMA	<i>Koeleria macrantha</i>	69–120	–
	mat muhly	MURI	<i>Muhlenbergia richardsonis</i>	69–120	–
3				1138–2040	
	Nebraska sedge	CANE2	<i>Carex nebrascensis</i>	1000–1800	–
	analogue sedge	CASI2	<i>Carex simulata</i>	69–120	–
	straightleaf rush	JUOR	<i>Juncus orthophyllus</i>	69–120	–
4				669–1520	
	Sierra rush	JUNE	<i>Juncus nevadensis</i>	69–120	–
Forb					
5				200–480	
	slender cinquefoil	POGR9	<i>Potentilla gracilis</i>	80–200	–
	plantainleaf buttercup	RAALA2	<i>Ranunculus alismifolius</i> var. <i>alismifolius</i>	80–160	–
	Chamisso arnica	ARCHI4	<i>Arnica chamissonis</i> ssp. <i>foliosa</i> var. <i>incana</i>	40–120	–
6				6–120	
	silverweed cinquefoil	ARAN7	<i>Argentina anserina</i>	6–80	–
	aster	ASTER	<i>Aster</i>	6–80	–
	falsegold groundsel	PAPSP2	<i>Packera pseud aurea</i> var. <i>pseud aurea</i>	6–80	–

Animal community

Several grazing animals seasonally use the site. Mule deer, elk, and antelope use the site for grazing. Elk are perhaps the most frequent animals on the site. Mule deer and elk use the site in the late winter and early spring. The proximity of pine forest (for cover and shelter) makes these sites desirable for grazing by elk and mule deer. The position of the site makes it attractive to grazing animals when the adjacent sites are wet; or adjacent forage is coarse and/or unpalatable. It is used as a resting and ruminating area when drier sites are not present. The site is marginal for nesting birds but may be seasonally used by waterfowl which nest in the adjacent meadow and marsh sites. The site is an important source of invertebrates for foraging birds. The site provides important habitat for grazing animals, shorebirds, raptors, and waterfowl. Lesser Sandhill Cranes may use the site in their search for food. The cranes scratch or till the ground to find and consume invertebrates. Larger grazing animals use the site for resting, ruminating, and grazing.

Hydrological functions

The site has a moderate potential in low seral condition to produce run-off to receiving waters. In some years, the site may be flooded with water backed up in the adjacent wetter sites. There are usually fingers of wetter and lower sites threading throughout the site providing extra ground water that may move laterally through the Wet Pumice Meadow Site. In good condition, the site provides stability to adjacent streambanks and floodplains; vegetation is usually resistant to flows.

Recreational uses

There is moderate recreational use on this site. Big game hunting, bird watching (especially for Lesser Sandhill Cranes), and trout fishing in adjacent streams are popular activities.

Wood products

None

Other products

None

Other information

The site is frequently used for grazing by domestic livestock and wildlife (mule deer, elk, and antelope). There are several species that are preferred that are available for most of the growing season. The site is highly productive and produces desirable and preferred forages for livestock throughout the growing season. Forages stay green (and presumably high in protein and digestible organic matter) well into the fall each year. The site can be heavily used because the slightly higher elevation and convex shape of this site makes it drier than adjacent marshy sites and therefore more attractive for resting, ruminating, and grazing.

The Tufted Hairgrass sites have evolved under frequent fire events. Fire may even be necessary for maintaining the dense stand of this grass (and its associated desirable forage and habitat qualities). If natural fire has been excluded from this site in the recent past, a program of rapid, moderately cool prescribed burns may be desirable to reduce litter and invigorate the grasses.

Contributors

Jeffrey P. Repp

Rangeland health reference sheet

Interpreting Indicators of Rangeland Health is a qualitative assessment protocol used to determine ecosystem condition based on benchmark characteristics described in the Reference Sheet. A suite of 17 (or more) indicators are typically considered in an assessment. The ecological site(s) representative of an assessment location must be known prior to applying the protocol and must be verified based on soils and climate. Current plant community cannot be used to identify the ecological site.

Author(s)/participant(s)	
Contact for lead author	
Date	
Approved by	
Approval date	
Composition (Indicators 10 and 12) based on	Annual Production

Indicators

1. Number and extent of rills:

2. Presence of water flow patterns:

3. Number and height of erosional pedestals or terracettes:

-
4. **Bare ground from Ecological Site Description or other studies (rock, litter, lichen, moss, plant canopy are not bare ground):**
-
5. **Number of gullies and erosion associated with gullies:**
-
6. **Extent of wind scoured, blowouts and/or depositional areas:**
-
7. **Amount of litter movement (describe size and distance expected to travel):**
-
8. **Soil surface (top few mm) resistance to erosion (stability values are averages - most sites will show a range of values):**
-
9. **Soil surface structure and SOM content (include type of structure and A-horizon color and thickness):**
-
10. **Effect of community phase composition (relative proportion of different functional groups) and spatial distribution on infiltration and runoff:**
-
11. **Presence and thickness of compaction layer (usually none; describe soil profile features which may be mistaken for compaction on this site):**
-
12. **Functional/Structural Groups (list in order of descending dominance by above-ground annual-production or live foliar cover using symbols: >>, >, = to indicate much greater than, greater than, and equal to):**
- Dominant:
- Sub-dominant:
- Other:
- Additional:
-
13. **Amount of plant mortality and decadence (include which functional groups are expected to show mortality or decadence):**
-
14. **Average percent litter cover (%) and depth (in):**
-

15. **Expected annual annual-production (this is TOTAL above-ground annual-production, not just forage annual-production):**

16. **Potential invasive (including noxious) species (native and non-native). List species which BOTH characterize degraded states and have the potential to become a dominant or co-dominant species on the ecological site if their future establishment and growth is not actively controlled by management interventions. Species that become dominant for only one to several years (e.g., short-term response to drought or wildfire) are not invasive plants. Note that unlike other indicators, we are describing what is NOT expected in the reference state for the ecological site:**

17. **Perennial plant reproductive capability:**
