

Ecological site R012XY012ID Loamy 12-16 PZ ARTRV/FEID-PSSPS

Last updated: 9/21/2020
Accessed: 05/05/2024

General information

Provisional. A provisional ecological site description has undergone quality control and quality assurance review. It contains a working state and transition model and enough information to identify the ecological site.

MLRA notes

Major Land Resource Area (MLRA): 012X—Lost River Valleys and Mountains

Land Resource Region: B (Northwestern Wheat and Range)
MLRA: 12 (Lost River Valleys and Mountains)

EPA EcoRegion: Level III (Middle Rockies)

LRU notes

012X-Lost River Valleys and Mountains

Precipitation or Climate Zone: 12-16" P.Z.
<https://soils.usda.gov/survey/geography/mlra/index.html>

Classification relationships

Similar to *Artemisia vaseyana*/*Agropyron spicatum* HT and *Artemisia vaseyana*/*Festuca idahoensis* HT in "Hironaka, M., M.A. Fosberg, A. H. Winward. 1983. Sagebrush- Grass Habitat Types of Southern Idaho. University of Idaho. Moscow, Idaho. Bulletin Number 35".

Ecological site concept

Site does not receive additional water.

Soils are:

Not saline or saline-sodic.

Deep to very deep. Not skeletal within 20" of soil surface.

Not strongly or violently effervescent in the to 20" of the soil profile.

textures usually range from silt loam to silty clay loam in surface mineral 4".

Slope is < 30%.

Clay content is = <35% in surface mineral 4".

Site does not have an argillic horizon with > 35% clay.

Associated sites

R012XY006ID	Windswept 8-16 PZ ARFR4/POSE
R012XY008ID	Gravelly 13-16 PZ ARTR4/PSSPS-FEID
R012XY020ID	Clayey 13-16 PZ ARAR8/FEID
R012XY029ID	Clayey South Slope 12-16 PZ ARAR8/PSSPS

Similar sites

R012XY021ID | Loamy 16-22 PZ ARTRV/FEID

Table 1. Dominant plant species

Tree	Not specified
Shrub	(1) <i>Artemisia tridentata ssp. vaseyana</i>
Herbaceous	(1) <i>Festuca idahoensis</i>

Physiographic features

This site occurs on gently undulating to somewhat rolling alluvial and colluvial foothill areas. Occasional rock outcrops may occur throughout the site. Slopes range from 5 to 30 percent on all aspects. Elevations range from 4800 to 8000 feet (1400-3450 meters).

Table 2. Representative physiographic features

Landforms	(1) Hill
Flooding frequency	None
Ponding frequency	None
Elevation	1,463–2,438 m
Slope	5–30%
Aspect	N, S, W

Climatic features

MLRA 12 is dominated by dramatic changes in elevation which, in turn, influence local weather patterns. The intermontane valleys have elevations as low as 3800 feet, while the adjacent mountains may reach more than 12,600 feet. The average annual precipitation for the entire MLRA, based on 10 long term climate stations located throughout the MLRA, is approximately 9.38 inches. However, the dry valleys may have averages as low as 6 inches, while the upper peaks may have averages that exceed 46 inches per year.

Temperatures vary considerably over the year. The average annual temperature is 42.25 degrees F. The average low is 27.4 degrees while the average high temperature is 57 degrees.

In the summer the sun shines 78% of the time, but drops to 40% in the winter. The prevailing wind is location-dependent, and generally flows parallel to the orientation of the dominant valleys. In the summer localized afternoon upslope winds and evening downslope winds are common. The average windspeed is greatest in the spring and early summer.

The frost free period ranges from 102 to 107 days while the freeze free period ranges from 134 to 139 days across the MLRA.

Table 3. Representative climatic features

Frost-free period (average)	107 days
Freeze-free period (average)	139 days
Precipitation total (average)	279 mm

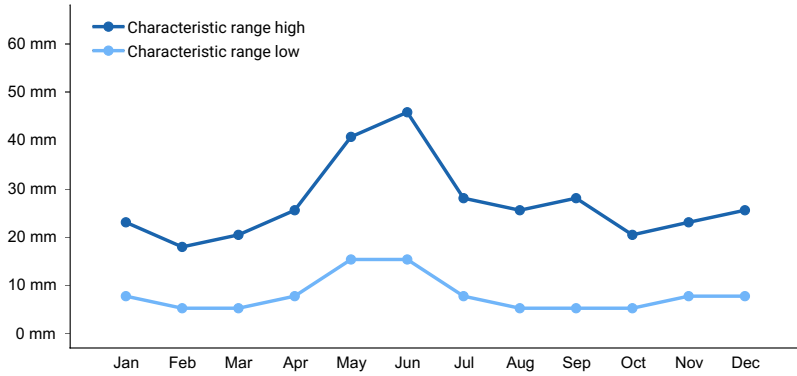

Figure 1. Monthly precipitation range

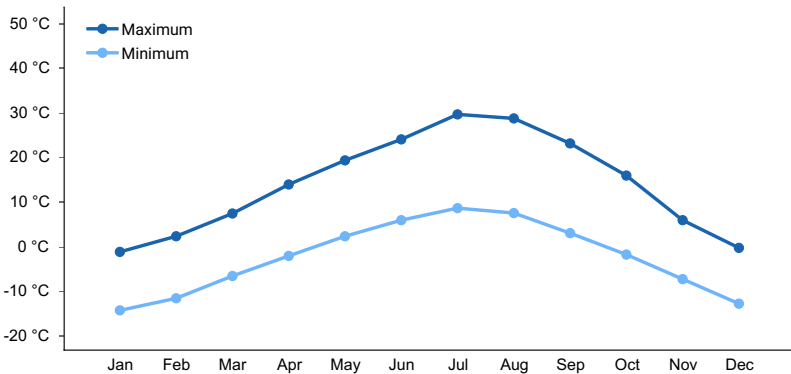

Figure 2. Monthly average minimum and maximum temperature

Influencing water features

This site is not influenced by adjacent wetlands, streams or run on.

Soil features

Soils are dark colored, medium textured, moderately deep to deep silt loams, silty clay loams and clay loams. They are moderately high in organic matter with medium to high permeability and are well drained. These soils have good available water holding capacity (AWC). Coarse fragments may be present but do not significantly affect vegetation. Erosion hazard ranges from slight to moderate, depending upon slope and ground cover.

Ecological dynamics

Ecological Dynamics of the Site:

The dominant visual aspect of this site is mountain big sagebrush in the overstory with bluebunch wheatgrass and Idaho fescue co-dominant in the understory. Composition by weight is approximately 60 to 70 percent grasses, 10 to 20 percent forbs and 15 to 25 percent shrubs.

During the last few thousand years, this site has evolved in an arid climate characterized by dry summers and cold, wet winters. Herbivory has historically occurred on this site at low levels of utilization. Herbivores include pronghorn antelope, mule deer, big horn sheep, Rocky Mountain elk, and lagomorphs.

Fire has historically occurred on the site at intervals of 20-50 years.

The Historic Climax Plant Community (HCPC) moves through many phases depending on the natural and man-made forces that impact the community over time. State 1, described later, indicates some of these phases. The HCPC is Phase A. This plant community is dominated by bluebunch wheatgrass, Idaho fescue, and mountain big sagebrush. Subdominant species can include Nevada bluegrass, Sandberg bluegrass, prairie junegrass, Thurber's needlegrass, arrowleaf balsamroot, and antelope bitterbrush. There can be a large variety of other grasses, forbs, and shrubs that occur in minor amounts. The plant species composition of Phase A is listed later under "HCPC

Plant Species Composition”.

Total annual production is 1050 pounds per acre (1176 kilograms per hectare) in a normal year. Production in a favorable year is 1450 pounds per acre (1624 kilograms per hectare). Production in an unfavorable year is 600 pounds per acre (672 kilograms per hectare). Structurally, cool season deep rooted perennial bunchgrasses are very dominant, followed by tall shrubs being more dominant than perennial forbs while shallow rooted perennial bunchgrasses are subdominant.

FUNCTION:

This site is well suited for big game summer and fall range. It is also well suited for livestock and recreation use in the late spring, summer, and fall.

Due to the relatively high rainfall, elevation, and deep soils on this site, it is fairly resistant to disturbances that can potentially degrade the site.

Due to the gentle topography, infiltration is normally high and runoff low. Runoff, when it does occur is non-erosive except during high intensity convection storms. Snow accumulates on the site due to high elevation and presence of tall shrubs.

Impacts on the Plant Community.

Influence of fire:

In the absence of normal fire frequency, mountain big sagebrush can increase. Grasses and forbs decrease as shrubs increase. With the continued absence of fire, juniper can displace most of the shrubs and other understory species. Utah juniper can also increase if a seed source is in the proximity. See “Influence of juniper invasion” below.

When fires become more frequent than historic levels (20-50 years), mountain big sagebrush and bitterbrush are reduced significantly. With continued short fire frequency, big sagebrush and bitterbrush can be completely eliminated along with many of the desirable understory species such as bluebunch wheatgrass and Idaho fescue. These species may be replaced by cheatgrass, Sandberg bluegrass, and bulbous bluegrass along with a variety of annual and perennial forbs including noxious and invasive plants. Some root-sprouting shrubs such as rabbitbrush, horsebrush, and snowberry may remain in the plant community or increase.

Influence of improper grazing management:

Season-long grazing and/or excessive utilization can be very detrimental to this site. This type of management leads to reduced vigor of the bunchgrasses and possibly bitterbrush. With reduced vigor, recruitment of these species declines. As these species decline, the plant community becomes susceptible to juniper invasion, an increase in mountain big sagebrush and noxious and invasive plants.

Continued improper grazing management influences fire frequency by increasing fine fuels. If cheatgrass increases and becomes co-dominant with Sandberg bluegrass and other annuals, fires become more frequent, particularly at lower elevations.

Proper grazing management that addresses frequency, duration, and intensity of grazing, can also keep fine fuels from developing, thereby reducing fire frequency. This can lead to gradual increases in mountain big sagebrush and/or Utah juniper. A planned grazing system can be developed to intentionally accumulate fine fuels in preparation for a prescribed burn. Any brush management should be carefully planned, as a reduction in shrubs without a suitable understory of perennial bunchgrasses can increase cheatgrass which will lead to more frequent fire intervals.

Weather influences:

Above normal precipitation in April, May, and June can dramatically increase total annual production of the plant community. These weather patterns can also increase viable seed production of desirable species to provide for recruitment. Likewise, below normal precipitation during these spring months can significantly reduce total annual production and be detrimental to viable seed production. Overall plant composition is normally not affected when perennials have good vigor.

Below normal temperatures in the spring can have an adverse impact on total production regardless of precipitation. An early, hard freeze can occasionally kill some plants.

Prolonged drought adversely affects this plant community in several ways. Vigor, recruitment, and production are usually reduced. Mortality can occur. Prolonged drought can lead to reductions in fire frequency.

Influence of Insects and disease:

Outbreaks can affect vegetation health, particularly bitterbrush with western tent caterpillars (*Malacosoma fragilis*). Two consecutive years of defoliation by the tent caterpillar can cause mortality in bitterbrush. Mormon cricket and grasshopper outbreaks occur periodically. Outbreaks seldom cause plant mortality since defoliation of the plant occurs only once during the year of the outbreak.

Snow mold can occasionally cause reduced vigor in mountain big sagebrush, but it is a short-term effect. An outbreak of a particular insect is usually influenced by weather but no specific data for this site is available.

Influence of noxious and invasive plants:

Many of these species add to the fine-fuel component and lead to increased fire frequency.

Many of the perennial invasive species with deep root systems compete with desirable plants for moisture and nutrients. The result is reduced production and change in composition of the understory.

Influence of wildlife:

Big game animals use this site in the spring, summer, and fall. Their numbers are seldom high enough to adversely affect the plant community. Big game numbers within this MLRA are usually limited by the winter range, not the summer range. Herbivory can be detrimental to bitterbrush when livestock grazing and browsing by big game occurs at the same time and season. This will occur when both kinds of animal are using the plant in the late summer or fall. The adverse impact is excessive use of the current years' leader growth.

The deer mouse is beneficial to this site as it is the principal vector for planting bitterbrush seed.

Watershed:

Decreased infiltration and increased runoff occur with the invasion of juniper (see Influence of Juniper below). Juniper invasion can be triggered by lack of fire, poor grazing management, and prolonged drought. The increased runoff also causes sheet and rill erosion. Abnormally short fire frequency also gives the same results, but to a lesser degree. The long term effect is a transition to a different state.

Influence of juniper invasion:

The following discussion deals with Utah juniper.

In plant communities that are invaded by juniper, the species has a competitive advantage for the following reasons:

- Juniper is very drought tolerant.
- It has the ability to extract soil moisture from a wide range of soil depths.
- Juniper has high evapo-transpiration rates.
- The species intercepts rain and snow before it reaches the soil surface.
- It has the ability to grow as long as there is soil moisture and the temperature is above freezing.
- Juniper has a relatively rapid growth rate and is long-lived. It can readily over-top shade intolerant species which leads to mortality.
- Nutrient cycling is reduced.
- As the canopy closes, juniper gains control of energy capture.

As juniper extracts water, other plants are unable to acquire sufficient water and nutrients to sustain growth and reproduction, thus reducing cover and biomass in the interspaces. After the canopy closes, there is sufficient soil moisture available for shallow-rooted, shade tolerant species to persist directly under the tree.

The following hydrological impacts occur on sites invaded by juniper:

- Infiltration in the interspaces is reduced.
- Run-off increases resulting in increased sheet and rill erosion with elevated sediment loads.
- Soil temperatures increase in the interspaces which results in accelerated drying of the soil surface.
- Increased bare ground in the interspaces.
- Soil moisture storage is reduced.

As bare ground and interconnectiveness of bare ground increases, flow rates are accelerated (reduction of flow sinuosity) and run-off out of the area increases.

Degradation of these systems can result in the formation of a feedback cycle in which greater juniper cover and density results in greater plant and soil disturbance between the canopies.

In summary, a closed juniper community takes control of the following ecological processes: hydrology, energy capture and nutrient cycling. The changes are primarily driven by the hydrological processes. The development of a closed juniper canopy always results in a transition across the threshold to a different state. Generally, when juniper canopy cover nears 20%, the plant community is approaching the threshold.

Plant Community and Sequence:

Transition pathways between common vegetation states and phases:

State 1.

Phase A to B. Develops with improper grazing management and in the absence of fire. There is a Utah juniper seed source present in the vicinity.

Phase A to C. Results from a wildfire, prescribed burning, or brush management.

Phase A to D. Results from improper grazing management and no fire. There is no Utah juniper seed source present in the vicinity.

Phase B to C. Results from a wildfire or brush management.

Phase B to A. Occurs with prescribed grazing and brush management or prescribed burning.

Phase C to A. Results from prescribed grazing and no fire.

Phase D to A. Occurs with prescribed grazing.

Phase D to C. Occurs with fire or prescribed burning and prescribed grazing.

Phase C to D. Occurs with no fire and improper grazing management.

State 1 Phase C to State 2. Develops through improper grazing management and frequent fire. This site has crossed the threshold. It is economically impractical to return this state to State 1 with accelerated practices.

State 1, Phase B to 3. Develops with no fire and improper grazing management from a juniper invaded phase of State 1. This site has crossed the threshold. It is economically impractical to return this state to State 1 with accelerated practices.

State 2 to unknown site. Excessive soil loss and changes in the hydrologic cycle caused by improper grazing management and no fire or frequent fire cause this state to cross the threshold and regress to a new site with reduced potential. It is economically impractical to return this state to State 1 with accelerated practices.

State 3 to unknown site. Continued lack of fire or improper grazing management cause this state to cross the threshold and regress to a new site with reduced potential due to significant soil loss and changes in hydrology. It is economically impractical to return this state to State 1 with accelerated practices.

State 2 to State 4. Develops from rangeland seeding.

State 3 to State 4. Develops with brush management and range seeding.

Practice Limitations:

Only slight limitations exist on this site for implementing vegetative management practices. Occasional areas of rock outcrop may restrict livestock movement. There are slight to moderate limitations for implementing facilitating practices such as fencing or water facilities. Stones or gravels in the subsoil may make fence posts or pipe installation somewhat difficult. There are only slight limitations to implementing accelerating practices such as rangeland seeding or brush management. Because of the diversity of resource values provided by this site, careful consideration of the impacts and effects of the planned practices on all uses must be considered.

State and transition model

The Reference State (State 1), the Historic Climax Plant Community (HCPC), moves through many phases depending on the natural and man-made forces that impact the community over time. The Reference Plant Community Phase is Phase A, State 1. The plant species composition of Phase A is listed later under "Reference Plant Community Phase Plant Species Composition".

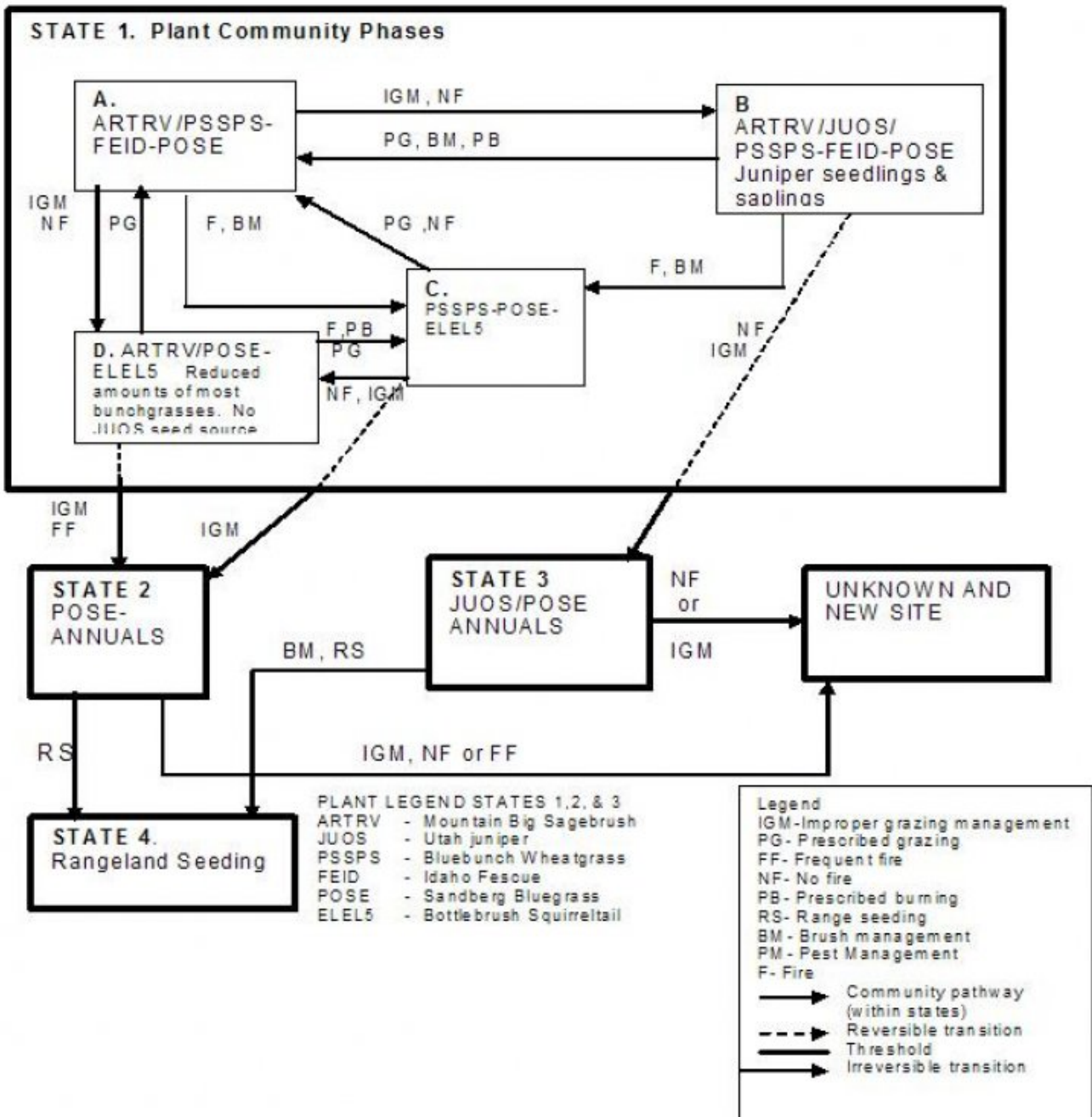

State 1

State 1, Plant community A. Historic Climax Plant Community (HCPC).

Community 1.1

State 1, Plant community A. Historic Climax Plant Community (HCPC).

The HCPC has mountain big sagebrush in the overstory with bluebunch wheatgrass and Idaho fescue in the understory. Antelope bitterbrush can be present. Subdominant species can include Nevada bluegrass, Sandberg bluegrass, prairie junegrass, Thurber's needlegrass, arrowleaf balsamroot, and antelope bitterbrush. There can be a large variety of other grasses, forbs and shrubs that occur in minor. Natural fire frequency is 20-50 years.

Table 4. Annual production by plant type

Plant Type	Low (Kg/Hectare)	Representative Value (Kg/Hectare)	High (Kg/Hectare)
Grass/Grasslike	437	768	1065
Shrub/Vine	135	280	325
Forb	101	179	235
Total	673	1227	1625

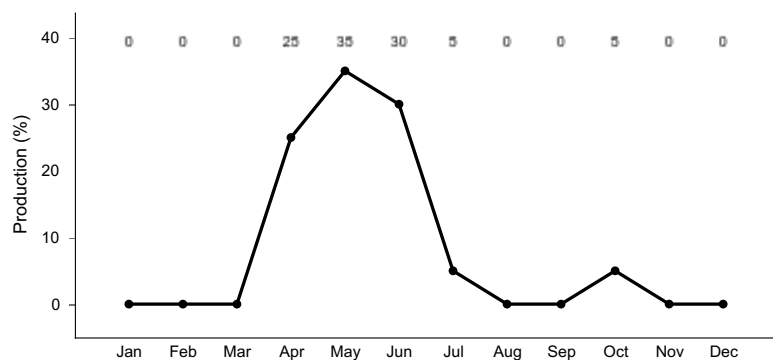

Figure 4. Plant community growth curve (percent production by month). ID0705, ARTRV-PSSPS-FEID. State 1.

State 2

State 1, Plant community B

Community 2.1

State 1, Plant community B

This plant community is dominated in the overstory by mountain big sagebrush with some Utah juniper seedlings and saplings invading. Bluebunch wheatgrass and Idaho fescue are still in the understory but with reduced amounts and in low vigor. Sandberg bluegrass is the subdominant grass species with small amounts of slender wheatgrass and thickspike wheatgrass in low vigor. Bottlebrush squirreltail and some forbs have increased. Antelope bitterbrush may be present but in reduced amounts and may be hedged. A Utah juniper seed source is present in nearby sites. Some cheatgrass may have invaded at lower elevations or other annuals. This state has developed due to fire frequency being much longer than normal or improper grazing management with no fire.

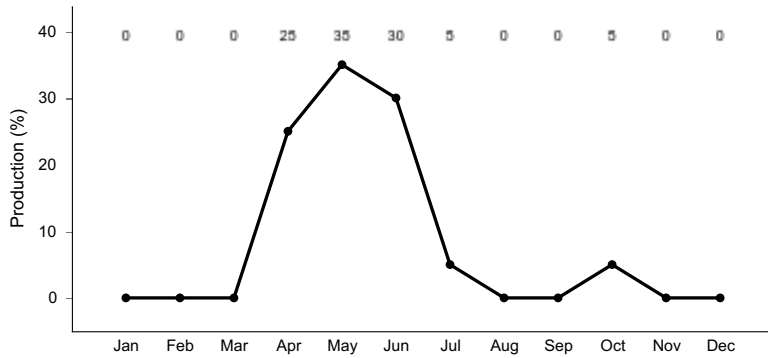

Figure 5. Plant community growth curve (percent production by month). ID0705, ARTRV-PSSPS-FEID. State 1.

**State 3
State 1, Plant community C**

**Community 3.1
State 1, Plant community C**

This plant community is dominated by bluebunch wheatgrass. Sandberg bluegrass, bottlebrush squirreltail and other perennial grasses and forbs are subdominant. Idaho fescue and Thurber’s needlegrass have decreased and may have died out due to fire. Most shrubs are absent from the site due to recent fire, except for some root-sprouting shrubs such as rabbitbrush, horsebrush, and snowberry may be present. Some cheatgrass may have invaded at lower elevation or other annuals. The community is a result of recent wildfire, prescribed burning or brush management.

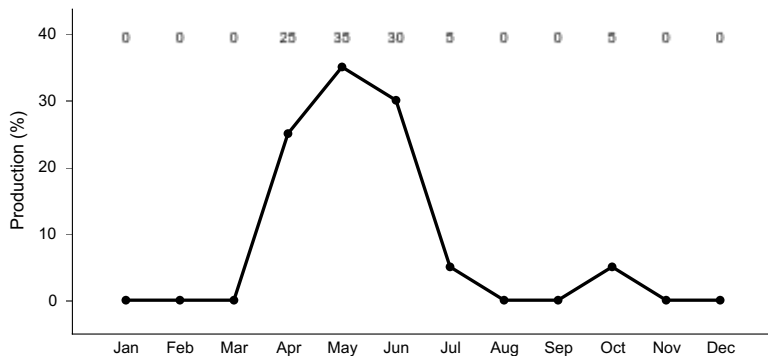

Figure 6. Plant community growth curve (percent production by month). ID0705, ARTRV-PSSPS-FEID. State 1.

**State 4
State 1, Plant community D**

**Community 4.1
State 1, Plant community D**

This plant community is dominated by mountain big sagebrush in the overstory with reduced amounts of bluebunch wheatgrass and Idaho fescue in reduced vigor. Sandberg bluegrass and bottlebrush squirreltail have increased. Slender wheatgrass and thickspike wheatgrass as well as most perennial forbs are about the same as in Plant Community A. Other bunchgrasses have been reduced and are in low vigor. Antelope bitterbrush, if present, has reduced vigor and may be hedged in shape. There is no Utah juniper seed source in the proximity. Some cheatgrass may have invaded at lower elevations or other annuals. This plant community has developed due to improper grazing management and no fire.

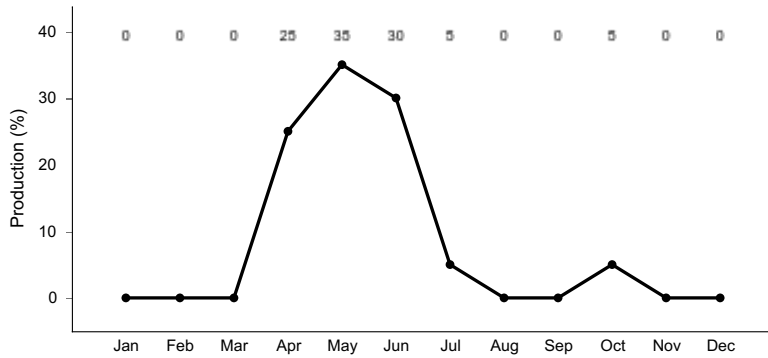

Figure 7. Plant community growth curve (percent production by month). ID0705, ARTRV-PSSPS-FEID. State 1.

**State 5
State 2**

**Community 5.1
State 2**

This plant community is dominated by Sandberg bluegrass and annuals in the understory. Cheatgrass is a dominant annual in the community, particularly at lower elevations. There may be a variety of weedy forbs and some noxious plants may have invaded the site. Some soil loss has occurred. The community has developed due to continued improper grazing management and frequent fire from Phase D State 1 or from improper grazing management from Phase C State 1. This site has crossed the threshold. It is economically impractical to return this state to State 1 with accelerated practices.

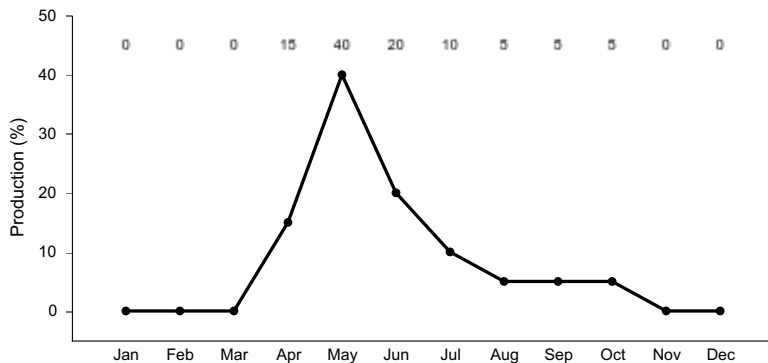

Figure 8. Plant community growth curve (percent production by month). ID0702, POSE/ BRTE- ANNUALS. State 2.

**State 6
State 3**

**Community 6.1
State 3**

This plant community is dominated by Utah juniper with Sandberg bluegrass and annuals in the understory. Cheatgrass is a dominant annual at lower elevations. There are few shrubs present due to competition from junipers. Some deep-rooted perennials may be present under the junipers. This community has developed due to the continued lack of fire and improper grazing management from Phase B State 1. This site has crossed the threshold. It is economically impractical to return this state to State 1 with accelerated practices.

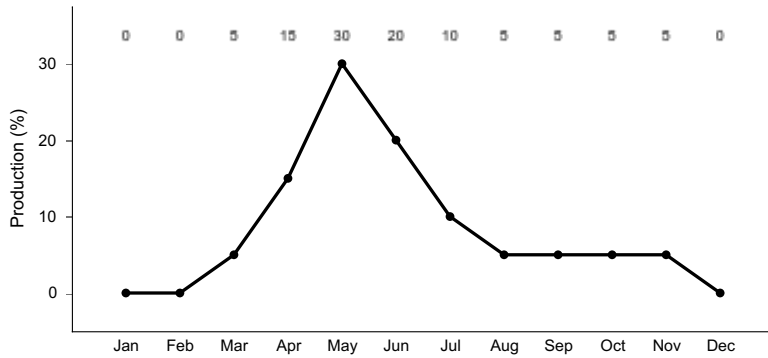

Figure 9. Plant community growth curve (percent production by month). ID0703, B12 Early Seral, JUOS. State 3.

**State 7
Unknown Site**

**Community 7.1
Unknown Site**

Excessive soil loss and changes in the hydrologic cycle caused by improper grazing management, no fire, or frequent fire cause this state to cross the threshold and retrogress to a new site with reduced potential. It is economically impractical to return this state to state 1 with accelerated practices.

Additional community tables

Animal community

Wildlife Interpretations.

Animal Community – Wildlife Interpretations

This rangeland ecological site provides diverse habitat for many native wildlife species. The plant community exhibits a diverse mixture of forbs throughout the growing season offering excellent habitat for invertebrates. Mule deer, pronghorn antelope, and elk may utilize the site at different times of the year. The site provides seasonal habitat for resident and migratory animals including western toad, shrews, bats, ground squirrels, mice, coyote, red fox, badger, Ferruginous hawk, and prairie falcon. Area sensitive bird species include Brewer’s sparrow, sage thrasher, sage sparrow, and sage-grouse. Water features are sparse provided by seasonal streams, artificial water catchments, and springs.

State 1 Phase 1.1 – Mountain Big Sagebrush/ Idaho Fescue/ Bluebunch Wheatgrass/ Sandberg Bluegrass Reference Plant Community (RPC): This plant community provides a diversity of grasses, forbs, and shrubs used by native insect communities that assist in pollination. An extensive array of forbs is represented throughout the growing season leading to a diverse insect community. Many avian and mammal species utilize this habitat based on the availability of invertebrate prey species. The reptile and amphibian community is represented by leopard lizard, short horned lizard, western skink, western toad, and northern leopard frog. Amphibians are associated with springs and isolated water bodies adjacent to this plant community. Development of spring sites that collect all available water would exclude amphibian use on these sites. Native shrub-steppe obligate avian species utilizing the habitat include the Brewer’s sparrow, sage sparrow, sage grouse, and sage thrasher. Sage-grouse habitat (leks, nesting, brood-rearing, and winter) is provided by this plant community. The plant community provides seasonal forage and cover for large mammals including mule deer, pronghorn antelope, and elk. Antelope bitterbrush may be present in this plant community along with Idaho fescue and bluebunch wheatgrass which are important forage species for these animals. A diverse small mammal population including golden-mantled ground squirrels, jackrabbits, deer mice, Great Basin Kangaroo rat, and chipmunks utilize this plant community. Pikas may utilize the site if adjacent to rocky open areas. The deer mouse is beneficial to this site as it is the principal vector for planting bitterbrush seed.

State 1 Phase 1.2- Mountain Big Sagebrush/ Utah Juniper/ Idaho Fescue/ Bluebunch Wheatgrass/ Sandberg

Bluegrass Plant Community: This plant community is the result of improper grazing management and no fire. An increase in canopy cover of sagebrush and juniper contributes to a sparse herbaceous understory. A reduced herbaceous understory results in lower diversity and numbers of insects. The reptile community will be similar to State 1 Phase 1.1 community represented by leopard lizard, short horned lizard, sagebrush lizard, and western skink. The reduced diversity of insects and understory cover may reduce the quality of food and cover for reptile populations. As juniper increases, habitat cover for Brewer's sparrow, sage thrasher, and sage sparrow may increase. Remaining sagebrush provides brood-rearing habitat, winter cover, and winter food for sage-grouse, but as juniper encroaches the quality of this habitat is severely reduced or eliminated. The plant community supports limited seasonal habitat for mule deer, elk, and pronghorn antelope. As juniper encroaches the site will provide additional thermal cover for large mammals. A small mammal population including golden-mantled ground squirrels, chipmunks, yellow-bellied marmots, and pikas may utilize this site.

State 1 Phase 1.3 – Bluebunch Wheatgrass/ Sandberg Bluegrass/ Bottlebrush Squirreltail Plant Community: The plant community is a result of recent wildfire, prescribed burning, or brush management. The plant community, dominated by herbaceous vegetation with little to no sagebrush or antelope bitterbrush would provide less vertical structure for animals. Patches of root sprouting shrubs (snowberry and rabbitbrushes) may be present to provide limited vertical structure for wildlife. Insect diversity would be reduced but a native forb plant community similar to State 1 Phase 1.1 would still support select pollinators. Reptiles including leopard lizard and short horned lizard would be limited or excluded due to the loss of sagebrush. Amphibian habitat would be tied to permanent spring sites in the area. Development of spring sites that collected all available water would exclude the use of amphibians on these sites. The dominance of herbaceous vegetation with little sagebrush or antelope bitterbrush canopy cover would limit use of these areas as nesting habitat by Brewer's sparrow, sage sparrow, and sage thrasher. The dominant herbaceous vegetation improves habitat for grassland avian species (horned lark, savannah sparrow, vesper sparrow, and western meadowlark). Mule deer and elk use would be seasonal but the site would offer little thermal cover or young of year cover due to the loss of shrub cover. The populations of small mammals would be dominated by open grassland species like the Columbian ground squirrel. Large blocks of this plant community would fragment the reference plant community and reduce the quality of the habitat for shrub-steppe obligate animal species.

State 1 Phase 1.4 – Mountain Big Sagebrush / Sandberg Bluegrass/ Bottlebrush Squirreltail Plant Community: This plant community is the result of improper grazing management and no fire. An increase in canopy cover of sagebrush contributes to a sparse herbaceous understory. Grasses, forbs, and shrubs are used by native insects that assist in pollination but the reduced herbaceous understory results in lower diversity of insects. The reptile community is represented by leopard lizard, short horned lizard, sagebrush lizard, western skink, and western rattlesnake. The reduced diversity of insects may reduce reptile populations and diversity. Reduced herbaceous understory is a key factor in limiting the use of this plant community by avian species. Key shrub-steppe obligate avian species include Brewer's sparrow, sage sparrow, sage thrasher, and sage-grouse. Critical habitat (brood-rearing and nesting cover) for sage-grouse is limited due to a less diverse herbaceous plant community. Winter habitat (cover and food) for sage-grouse is provided. The reduced vigor of understory vegetation results in a shorter forage season for mule deer, elk, and pronghorn antelope. Young of year cover would be provided for deer and pronghorn antelope. Small mammal diversity and populations would be similar to State 1 Phase 1.1.

State 2 – Sandberg/ Annuals Plant Community:

This community has developed due to continued improper grazing management and frequent fire from State 1 Phase 1.4 or from improper grazing management from State 1 Phase 1.3. The plant community does not support a diverse insect community. The reduced forb and shrub components in the plant community would support a very limited population of pollinators. Most reptilian species are not supported with food, water, or cover. This plant community does not support the habitat requirements for sage thrasher, Brewer's sparrow, sage-grouse, or sage sparrow. Diversity of grassland avian species is reduced due to poor cover and available food. Birds of prey including hawks and falcons may range throughout these areas looking for prey species. Large mammals may utilize the herbaceous vegetation in the early part of the year when the invasive annuals (cheatgrass) are more palatable. The populations of small mammals would be dominated by open grassland species like the Columbian ground squirrel. Large blocks of this plant community would fragment reference plant community and reduce the quality of the habitat for shrub-steppe obligate animal species.

State 3 - Utah Juniper/ Sandberg Bluegrass/ Annuals Plant Community: This state has developed due to improper grazing management and no fire. The loss of native forbs and understory vegetation will reduce insect diversity on

the site. The lack of flowering plants will limit use by pollinators like butterflies and moths. Most reptilian species identified in State 1 Phase 1.1 are not supported with food, water, or cover. This plant community does not support the habitat requirements for sage-grouse. Birds using this site as resident or migratory habitat include Juniper titmouse, western bluebird, and Virginia's warbler. The Juniper titmouse relies heavily on juniper seeds for winter food. Hunting success by raptors may decrease due to a heavy overstory of juniper. The plant community supports limited seasonal habitat for mule deer, elk, and pronghorn antelope in spring and fall. As juniper encroaches the site will provide additional thermal cover for large mammals.

State 4 – Rangeland Seeding Plant Community: The seeding mixture (native or non-native) determines the animal species that utilize this site. A diverse seed mixture of grasses and forbs would provide similar habitat conditions as described in State 1 phase 1.3. A diverse seed mixture of grasses, forbs, and shrubs would provide similar habitat conditions as described in State 1 phase 1.1, 1.2, or 1.4. A monoculture of non-native grass species would not support diverse populations of insects, reptiles, avians, mammals, or sagebrush obligate animal species. Grassland animal species including western meadowlark, horned lark, savannah sparrow, deer mouse, kangaroo rat, mule deer, and elk would utilize this site for nesting and/or foraging. Birds of prey including hawks and falcons may range throughout this community looking for prey species. Large areas of State 4 with no shrubs in the plant community would fragment the reference plant community and would severely reduce the quality of the habitat for shrub obligate animal species.

Grazing Interpretations.

This site is best adapted for livestock grazing in the late spring, summer, and fall. Natural water supplies can be short at times, but water is generally available on adjacent sites.

Estimated initial stocking rate will be determined with the landowner or decision-maker. They will be based on the inventory which includes species, composition, similarity index, production, past use history, season of use and seasonal preference. Calculations used to determine estimated initial stocking rate will be based on forage preference ratings.

Hydrological functions

The soils in this site are in hydrologic group B. They have moderately low runoff potential.

Recreational uses

This site has little recreation value but there are some opportunities for hunting, hiking, horseback riding, off-road vehicle use, and photography.

Wood products

None

Other products

None

Inventory data references

Information presented here has been derived from NRCS clipping and other inventory data. Also, field knowledge of range-trained personnel was used. Those involved in developing this site description include:

Dave Franzen, co-owner, Intermountain Rangeland Consultants, LLC

Jacy Gibbs, co-owner, Intermountain Rangeland Consultants, LLC

Jim Cornwell, Range Management Specialist, IASCD

Joe May, State Rangeland Management Specialist, NRCS, Idaho

Lee Brooks, Rangeland Management Specialist, IASCD

Type locality

Location 1: Custer County, ID	
Township/Range/Section	T11 R26 S6
General legal description	11 N. 26 E. SE ¼, SE ¼, Sec. 6 (Custer)
Location 2: Clark County, ID	
Township/Range/Section	T11 R38 S4
General legal description	11 N. 38 E. S ½, Sec. 4 (Clark) Field Offices. Salmon Challis Arco Rexburg Rigby

Other references

Hironaka, M., M.A. Fosberg, A. H. Winward. 1983. Sagebrush- Grass Habitat Types of Southern Idaho. University of Idaho. Moscow, Idaho. Bulletin Number 35.

Petersen, S.L., 2004. A Landscape-Scale Assessment of Plant Communities, Hydrologic Processes, and State-and-Transition Theory in a Western Juniper Dominated Ecosystem. PhD Dissertation. Oregon State University, Corvallis, Oregon.

USDA Forest Service, Rocky Mountain Research Station. 2004. Restoring Western Ranges and Wildlands. General Technical Report RMRS-GTR-136-vols. 1-3.

USDA, NRCS.2001. The PLANTS Database, Version 3.1 (<http://plants.usda.gov>). National Plant Data Center, Baton Rouge, LA 70874-4490 USA

USDA, Forest Service, Fire Effects Information Database. 2004. www.fs.fed.us/database/feis

USDI Bureau of Land Management, US Geological Survey; USDA Natural Resources Conservation Service, Agricultural Research Service; Interpreting Indicators of Rangeland Health. Technical Reference 1734-6; version 4-2005.

Contributors

DLF

Approval

Kendra Moseley, 9/21/2020

Rangeland health reference sheet

Interpreting Indicators of Rangeland Health is a qualitative assessment protocol used to determine ecosystem condition based on benchmark characteristics described in the Reference Sheet. A suite of 17 (or more) indicators are typically considered in an assessment. The ecological site(s) representative of an assessment location must be known prior to applying the protocol and must be verified based on soils and climate. Current plant community cannot be used to identify the ecological site.

Author(s)/participant(s)	Dave Franzen and Jacy Gibbs.
Contact for lead author	Joe May, State Range Conservationist USDA-NRCS 9173 W. Barnes Drive, Suite C Boise, ID 83709
Date	03/27/2007
Approved by	Kendra Moseley
Approval date	

Indicators

- 1. Number and extent of rills:** Rills: rarely occur on this site. If rills are present they are likely to occur on slopes greater than 15 percent and immediately following wildfire. Rills are most likely to occur on soils with surface textures of silt loam and clay loam.

- 2. Presence of water flow patterns:** Water-Flow Patterns: rarely occur on this site. When they occur they are short and disrupted by cool season grasses and tall shrubs and are not extensive.

- 3. Number and height of erosional pedestals or terracettes:** Pedestals and/or Terracettes: are rare on this site. In areas where slopes approach 15 percent and where flow patterns and/or rills are present, a few pedestals may be expected.

- 4. Bare ground from Ecological Site Description or other studies (rock, litter, lichen, moss, plant canopy are not bare ground):** Bare Ground: data is not available. On sites in mid-seral status bare ground may range from 25-45 percent.

- 5. Number of gullies and erosion associated with gullies:** Gullies: none

- 6. Extent of wind scoured, blowouts and/or depositional areas:** Wind-Scoured, Blowouts, and/or Deposition Areas: usually not present. Immediately following wildfire some soil movement may occur on lighter textured soils.

- 7. Amount of litter movement (describe size and distance expected to travel):** Litter Movement: fine litter in the interspaces may move up to 2 feet following a significant run-off event. Coarse litter generally does not move.

- 8. Soil surface (top few mm) resistance to erosion (stability values are averages - most sites will show a range of values):** Soil Surface Resistance to Erosion: values should range from 4 to 6 but needs to be tested.

- 9. Soil surface structure and SOM content (include type of structure and A-horizon color and thickness):** Soil Surface Loss or Degradation: the A or A1 horizon is typically 2 to 10 inches thick. Structure ranges from weak or moderate very fine or fine granular, weak thin platy, to weak fine, very fine or medium subangular blocky. Soil organic matter (SOM) ranges from 1 to 6 percent.

- 10. Effect of community phase composition (relative proportion of different functional groups) and spatial distribution on infiltration and runoff:** Plant Community Composition and Distribution Relative to Infiltration: bunchgrasses, especially deep-rooted perennials, slow run-off and increase infiltration. Tall shrubs accumulate snow in

the interspaces.

11. **Presence and thickness of compaction layer (usually none; describe soil profile features which may be mistaken for compaction on this site):** Compaction Layer: is not present.
-

12. **Functional/Structural Groups (list in order of descending dominance by above-ground annual-production or live foliar cover using symbols: >>, >, = to indicate much greater than, greater than, and equal to):**

Dominant: Functional/ Structural Groups: cool season deep rooted perennial bunchgrasses>>tall shrubs>perennial forbs>shallow rooted bunchgrasses.

Sub-dominant:

Other:

Additional:

13. **Amount of plant mortality and decadence (include which functional groups are expected to show mortality or decadence):** Plant Mortality/ Decadence: mountain big sagebrush will become decadent in the absence of fire and ungulate grazing. Grass and forb mortality will occur as tall shrubs increase.
-

14. **Average percent litter cover (%) and depth (in):** Litter Amount: additional litter cover data is needed but is expected to be 20-25 percent to a depth of 0.2 inches. Under mature shrubs litter is >0.5 inches deep and is 90-100 percent ground cover.
-

15. **Expected annual annual-production (this is TOTAL above-ground annual-production, not just forage annual-production):** Annual Production: is 1050 pounds per acre (1176 kilograms per hectare) in a year with normal temperatures and precipitation. Perennial grasses produce 60-70 percent of the total production, forbs 10-20 percent and shrubs 15-25 percent.
-

16. **Potential invasive (including noxious) species (native and non-native). List species which BOTH characterize degraded states and have the potential to become a dominant or co-dominant species on the ecological site if their future establishment and growth is not actively controlled by management interventions. Species that become dominant for only one to several years (e.g., short-term response to drought or wildfire) are not invasive plants. Note that unlike other indicators, we are describing what is NOT expected in the reference state for the ecological site:** Invasive Plants: includes cheatgrass, clasping pepperweed, beggar ticks, tansymustard, Jim Hill tumbledustard, yellow salsify, burr buttercup, medusahead, Russian thistle, annual kochia, and halogeton.
-

17. **Perennial plant reproductive capability:** Reproductive Capability of Perennial Plants: all functional groups have the potential to reproduce in most years.
-

