

## Ecological site BX013X01B004 Clayey Bear River Valley 10-14" P.Z.

Last updated: 5/01/2024  
Accessed: 05/17/2024

---

### General information

**Provisional.** A provisional ecological site description has undergone quality control and quality assurance review. It contains a working state and transition model and enough information to identify the ecological site.

### MLRA notes

Major Land Resource Area (MLRA): 013X–Eastern Idaho Plateaus

Major Land Resource Area (MLRA) 13, Eastern Idaho Plateaus, consists of approximately 5 million acres in Idaho with a small part in Utah and Wyoming, it consists of 6 Land Resource Units (LRU). These units are divisions of the MLRA based on geology, landscape, common soils, water resources and plant community potentials. The elevation ranges from approximately 4500 to 6600 feet (1370 to 2010 M) on the plateaus and foothills to as much as 9500 feet (2895 m) on the mountains. Annual precipitation ranges from 10 to 48 inches (254-1220 mm), with the driest areas in the Bear River Valley on the far eastern portion and the wettest areas on the mountain summits. The Fort Hall Indian Reservation and several national forests are in this MLRA, including the Caribou, Cache, and Targhee National Forests. Yellowstone and Grand Teton National Parks occur just outside the northeast boundary.

### LRU notes

The Bear River Valley LRU is located on the far western side of MLRA 13 between the Bear River Divide and the Monte Cristo Range, from Woodruff, Utah at the southern end to Cokeville, Wyoming at the northern end. The total area of the LRU is approximately 340,000 acres. It shares a boundary with MLRA 47 - Wasatch and Uinta Mountains, 43B - Central Rocky Mountains and 46 - Northern Rocky Mountain Foothills (proposed in Wyoming). This LRU differs from the others in its geology, which is comprised mostly of alluvium and colluvium from the Stump Formation. The soil moisture regime is xeric, meaning there is a slight peak in winter precipitation in this LRU, with typical annual precipitation between 10 and 15 inches (254-380 mm). The soil temperature regime of this LRU is frigid with mean annual soil temperatures ranging from 44 to 48 degrees Fahrenheit (6.7-8.8 C). The elevation range is from 5700 to 7000 feet (1730-2130 m). The soils in the Bear River Valley are dominated by young aged very deep soils developed from sandstone and shale parent material re-worked with recent alluvium. Soils are dominated by Alfisols with young argillic horizons and by Fluvents in more recent alluvium. The Bear River runs through this LRU, allowing for ample amounts of irrigation water used in the lowland areas to produce hay with smaller tributaries originating from the neighboring mountains.

### Classification relationships

Relationship to Other Established Classification Systems

National Vegetation Classification System (NVC):

3 Semi-Desert

3.B.1 Cool Semi-Desert Scrub & Grassland

3.B.1.Ne Western North American Cool Semi-Desert Scrub & Grassland Division

M169 Great Basin & Intermountain Tall Sagebrush Shrubland & Steppe Macrogroup

G303 Intermountain Dry Tall Sage Steppe and Shrubland Group

A3182 Wyoming big sagebrush Mesic Steppe and Shrubland Alliance

CEGL001047 *Artemisia tridentata* ssp. *wyomingensis*/*Pascopyrum smithii* Shrubland Association

Ecoregions (EPA):

Level I: 10 North American Deserts

Level II: 10.1 Cold Deserts

Level III: 10.1.4 Wyoming Basin

## Ecological site concept

Clayey Bear River Valley 10-14" P.Z. (Cy-BRV) is an upland ecological site with heavy surface textures (>32% clay) within the top 6 inches that is not limited in water holding capacity (moderately deep to very deep with >6" AWC).

- This site does not receive any additional water.

- These soils are:

- o typically non-saline, but may be very slightly saline (<4 dS/m)

- o not sodic

- o moderately deep, deep, very deep soil depth

- o not skeletal within 20" (50 cm) of soil surface, with minimal rock fragments at the soil surface

- o not violently effervescent in surface mineral 10" (25 cm)

- o with surface textures that typically range from clay loam to clay in surface mineral 6" (15 cm)

- Slopes are less than 30 percent

- Clay content is 32-40% within top 6" (15 cm) of mineral soil surface

Climate:

xeric moisture regime

frigid temperature regime

## Associated sites

BX013X01B022	<b>Loamy Bear River Valley 10-14" P.Z.</b> This site has coarser soil surface textures, higher production and different species composition potential.
BX013X01B030	<b>Overflow Bear River Valley 10-14" P.Z.</b> This site is in a water receiving landscape position. While textures may be similar, this site receives additional moisture resulting in higher plant production and different species composition potential.

## Similar sites

BX013X01B024	<b>Loamy Argillic Bear River Valley 10-14" P.Z.</b> This site has a loam or clay loam soil surface texture with a heavy clay (argillic) subsurface within 10 to 20 inches, resulting in lower productivity and very different species composition potential.
R034AY204WY	<b>Clayey Foothills and Basins West (Cy)</b> Previous version of this site used in Wyoming

Table 1. Dominant plant species

Tree	Not specified
Shrub	(1) <i>Artemisia tridentata ssp. wyomingensis</i>
Herbaceous	(1) <i>Elymus lanceolatus ssp. lanceolatus</i> (2) <i>Pascopyrum smithii</i>

## Legacy ID

R013XA104WY

## Physiographic features

This site occurs on hillslope, alluvial fan, and fan remnant landforms at elevations between 5,700 and 7,000 feet.

This site occurs on all aspects. The slopes range from level to 30 percent. Runoff is low to moderate, and flooding and ponding do not occur on this site.

#### Landscape Definition:

hills -- A landscape dominated by hills and associated valleys.

valley -- An elongate, relatively large, externally drained depression of the Earth's surface that is primarily developed by stream erosion or glacial activity.

#### Landform Definition:

alluvial fan--A low, outspread mass of loose materials and/or rock material, commonly with gentle slopes. It is shaped like an open fan or a segment of a cone. The material was deposited by a stream at the place where it issues from a narrow mountain valley or upland valley, or where a tributary stream is near or at its junction with the main stream. The fan is steepest near its apex, which points upstream and slopes gently and convexly outward (downstream) with a gradual decrease in gradient.

hillslope -- A generic term for the steeper part of a hill between its summit and the drainage line, valley flat, or depression floor at the base of the hill.

fan remnant -- A general term for landforms that are the remaining parts of older, non-active fan- landforms, such as alluvial fans, fan aprons, inset fans, and fan skirts, that either have been dissected (erosional fan-remnants) or partially buried (non-buried fan-remnants). An erosional fan remnant must retain a relatively flat summit that is a relict fan-surface (greater than 50 percent intact). A non-buried fan-remnant is a relict surface in its entirety. Similar terms are eroded fan remnant, eroded fan remnant side slope, ballena.

**Table 2. Representative physiographic features**

Landforms	(1) Hills > Hillslope (2) Valley > Alluvial fan
Runoff class	Low to medium
Flooding frequency	None
Ponding frequency	None
Elevation	1,737–2,134 m
Slope	0–30%
Water table depth	152–508 cm
Aspect	Aspect is not a significant factor

#### Climatic features

Annual precipitation in the Bear River Valley ranges from 10 to 14 inches per year. Wide fluctuations may occur in yearly precipitation and result in more below average years than those with above average precipitation.

Temperatures show a wide range between summer and winter and between daily maximums and minimums. This is predominantly due to the high elevation and dry air, which permits rapid incoming and outgoing radiation. Cold air outbreaks in winter move rapidly from northwest to southeast and account for extreme minimum temperatures.

Roughly 25 to 30 percent of the precipitation occurs during the critical growth period, but the majority of precipitation accumulates outside the growing season, creating xeric-like conditions. The wettest rainfall month is May. The dominant plants (sagebrush and cool season grasses) are well adapted to these conditions. Daytime winds are generally stronger than nighttime and occasional strong storms may bring brief periods of high winds with gusts to more than 50 mph. The growing season is short (60 to 90 days) and cool (critical growth period): primary growth typically occurs between May and June. Growth of native cool-season plants begins about mid-April and continues to approximately early July. Some green-up of cool-season plants usually occurs in September with adequate fall moisture.

All data is based on the 30 year average from 1981 through 2010.

**Table 3. Representative climatic features**

Frost-free period (characteristic range)	40-90 days
--	------------

Freeze-free period (characteristic range)	50-110 days
Precipitation total (characteristic range)	254-356 mm
Frost-free period (actual range)	35-90 days
Freeze-free period (actual range)	30-110 days
Precipitation total (actual range)	203-406 mm
Frost-free period (average)	60 days
Freeze-free period (average)	80 days
Precipitation total (average)	305 mm

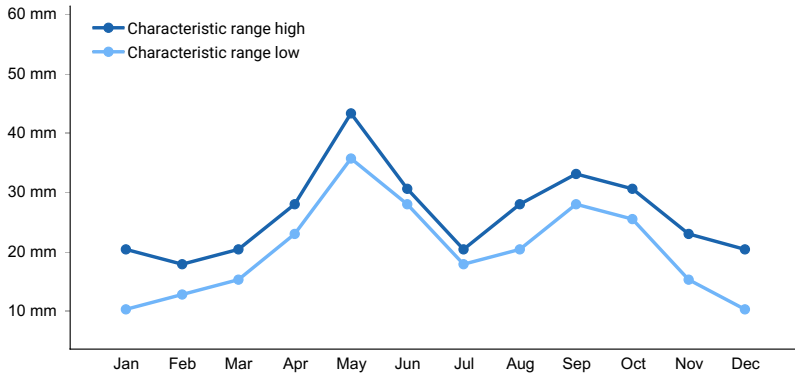

**Figure 1. Monthly precipitation range**

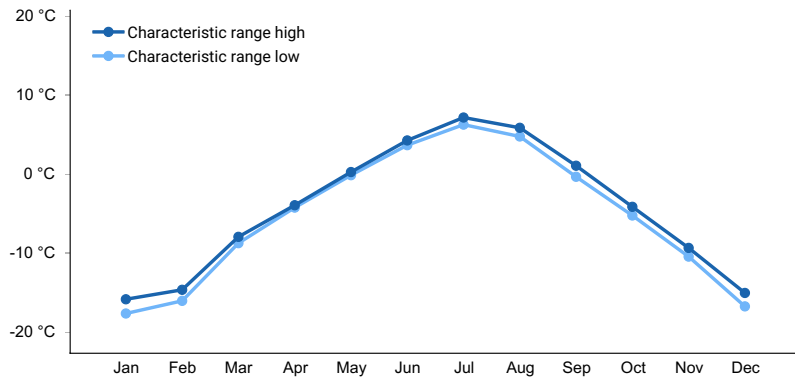

**Figure 2. Monthly minimum temperature range**

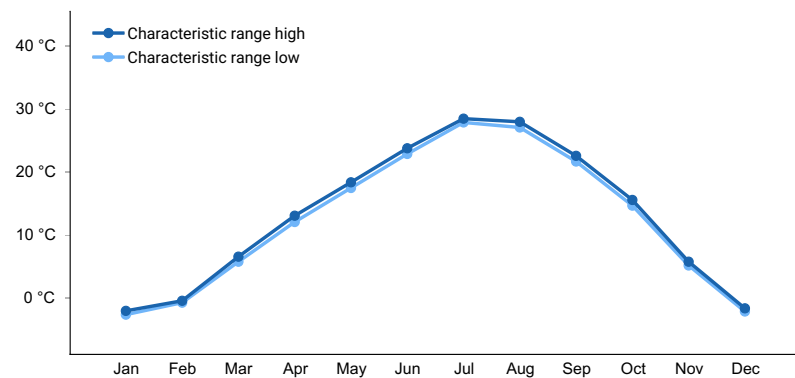

**Figure 3. Monthly maximum temperature range**

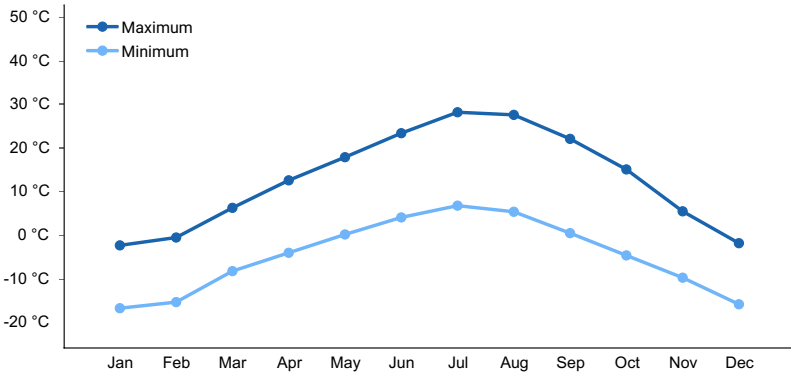

**Figure 4. Monthly average minimum and maximum temperature**

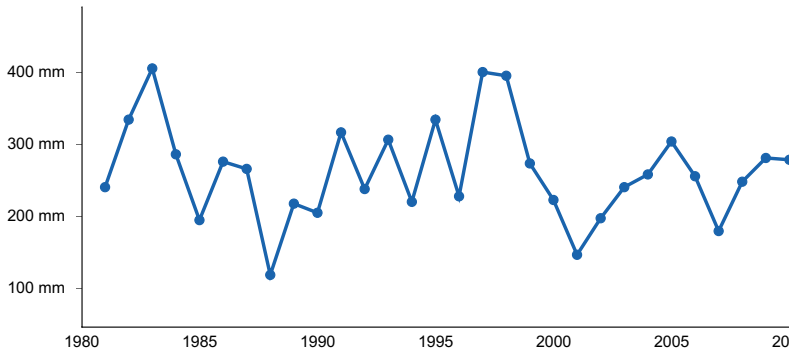

**Figure 5. Annual precipitation pattern**

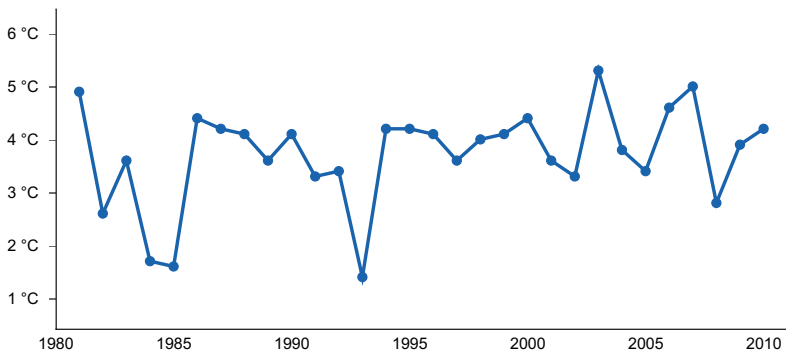

**Figure 6. Annual average temperature pattern**

### Climate stations used

- (1) WOODRUFF [USC00429595], Woodruff, UT
- (2) RANDOLPH [USC00427165], Randolph, UT
- (3) SAGE 4 NNW [USC00487955], Cokeville, WY

### Influencing water features

There are no influencing water features associated with this ecological site.

### Wetland description

N/A

### Soil features

These are moderately deep to very deep (20 to 200 inches) moderately well to well-drained soils formed in alluvium derived from inter-bedded sedimentary rock. Surface textures have more than 32 percent clay. Some soil cracking (not severe) occurs during the dry summer months. Water-holding capacity is high, but permeability is slow to very

slow.

Major Soil Series correlated to this site include: Stoffer, Murphy, Zagg, and Zegro

Taxonomy: Fine, smectitic, frigid, vertic Calcixerepts; Fine, mixed, superactive frigid Typic Calcixerepts; Fine, smectitic, calcareous, frigid Xerertic Torriorthents; Fine, mixed, superactive, calcareous, frigid Xeric Torriorthents

**Table 4. Representative soil features**

Parent material	(1) Alluvium–sandstone and shale (2) Colluvium–sandstone and shale (3) Slope alluvium–sandstone and shale
Surface texture	(1) Clay loam (2) Clay (3) Silty clay loam
Drainage class	Moderately well drained to well drained
Permeability class	Slow to very slow
Depth to restrictive layer	53–508 cm
Soil depth	51–508 cm
Surface fragment cover <=3"	1–10%
Surface fragment cover >3"	0–5%
Available water capacity (0-101.6cm)	15.24–20.32 cm
Calcium carbonate equivalent (0-50.8cm)	0–15%
Clay content (0-15.2cm)	32–40%
Electrical conductivity (0-50.8cm)	0–4 mmhos/cm
Sodium adsorption ratio (0-50.8cm)	0–3
Soil reaction (1:1 water) (25.4-50.8cm)	7.8–8.5
Subsurface fragment volume <=3" (15.2-50.8cm)	0–15%
Subsurface fragment volume >3" (15.2-50.8cm)	0–5%

## Ecological dynamics

A State-and-Transition Model (STM) diagram is depicted in this section. Thorough descriptions of each state, transition, plant community phase, and pathway are found after the model in this document. This diagram is based on available experimental research, field observations, professional consensus, and interpretations. While based on the best available information, the STM will change over time as knowledge of ecological processes increases.

Plant community composition within the same ecological site has a natural range of variability across the LRU due to the naturally occurring variability in weather, soils, and aspect. Not all managers will choose the Reference Plant Community as the management goal. Other plant communities may be desired to meet land management objectives. This is valid as long as the rangeland health attributes assessment departures are none to slight or slight to moderate from the Reference State. The biological processes on this site are complex; therefore, representative values are presented in a land management context. The species lists are representative and are not botanical descriptions of all species occurring, or potentially occurring, on this site. They are not intended to cover every situation or the full range of conditions, species, and responses for the site.

Both percent species composition by weight and percent cover are used in this ESD. Most observers find it easier to visualize or estimate percent cover for woody species (trees and shrubs). Foliar cover is used to define plant community phases and states in the State-and-Transition Model. Cover drives the transitions between communities and states because of the influence of shade and interception of rainfall.

Species composition by dry weight remains an important descriptor of the herbaceous community and of site productivity as a whole and includes both herbaceous and woody species. Calculating similarity index requires data on species composition by dry weight.

Although there is considerable qualitative experience supporting the pathways and transitions within the State-and-Transition Model, no quantitative information exists that specifically identifies threshold parameters between reference states and degraded states in this ecological site. For information on STMs, see the following citations: Bestelmeyer et.al. 2003, Bestelmeyer et.al. 2004, Bestelmeyer et.al. 2010, Bestelmeyer and Brown 2005, Briske et.al. 2008, and Stringham et.al. 2003.

A resource concern risk assessment and dominant resource concerns are provided for each Land Use, State, and Plant Community Phase based on NRCS resource concern and planning criteria used to determine resource treatment levels during the conservation planning process. A resource concern is the resource condition that does not meet the minimum accepted levels established by planning criteria as shown in Section III of the NRCS Field Office Technical Guide (<https://efotg.sc.egov.usda.gov/#/>).

- Low risk means a low probability for the category of resource concerns and additional assessment is typically not necessary.
- Medium risk means that the category of resource concerns could occur, and additional assessment is recommended if the identified resource is a client concern and/or objective.
- High risk means that a resource concern in that category is likely to occur.

The resource categories are: S (soil), W (water), A (air), P (plant), A (animal), E (energy), and H (human). The dominant resource concerns further refine the resource category to a specific resource concern within that category.

## State and transition model

### Land uses

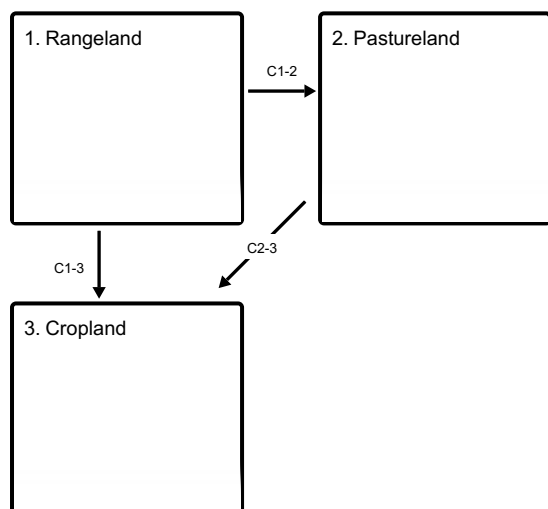

**C1-2** - Flood irrigation, tillage, and seeding

**C1-3** - Irrigation (improved flood or sprinkler), tillage, and seeding

**C2-3** - Sprinkler irrigation, tillage, and seeding

**Land use 1 submodel, ecosystem states**

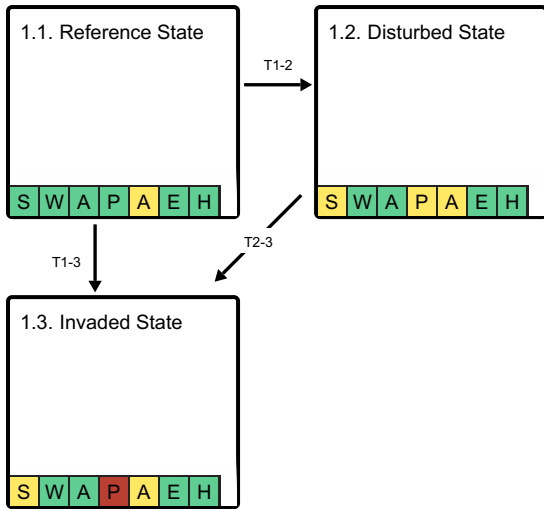

- T1-2** - Soil-disturbance (e.g. hoof action, rodents, water erosion) or chemical/mechanical treatment
- T1-3** - Extreme disturbance (e.g. catastrophic fire, drought, soil removal)
- T2-3** - Extreme herbivory (continuous, high intensity)

**State 1 submodel, plant communities**

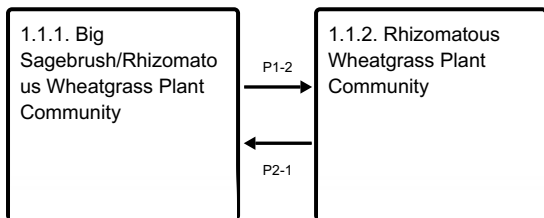

- P1-2** - Sage-killing event (severe drought, prolonged soil saturation, freeze-kill, snow mold, moderate intensity fire, herbivory, mechanical/chemical treatment)
- P2-1** - Natural Succession

**State 2 submodel, plant communities**

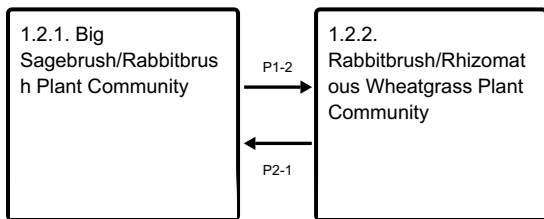

- P1-2** - Sage-killing event (high intensity fire, consecutive mechanical or chemical treatments)
- P2-1** - Natural Succession

**State 3 submodel, plant communities**

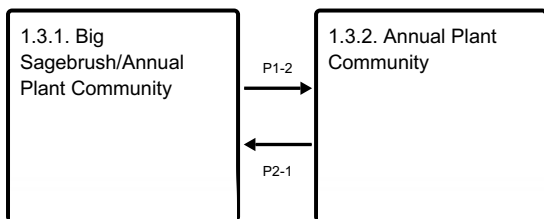

- P1-2** - Sage-killing event (catastrophic fire, mechanical treatment)
- P2-1** - Natural Succession



### Land use 2 submodel, ecosystem states

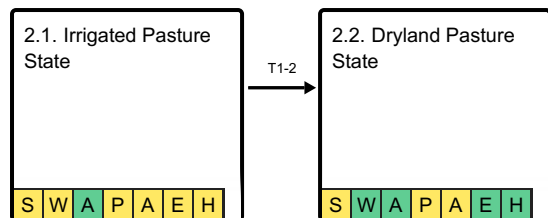

T1-2 - Irrigation abandonment

### Land use 3 submodel, ecosystem states

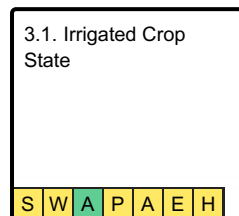

## Land use 1 Rangeland

Rangeland is the dominant land use for this site and provides the most diverse ecosystem services. Rangeland is land on which the historic and introduced vegetation is predominantly grasses, grass-like plants, forbs or shrubs managed as a natural ecosystem. Range may include natural grasslands, savannas, shrublands, tundra, alpine communities, marshes and meadows.

**Characteristics and indicators.** This land use consists of diverse native plant communities dominated by big sagebrush and perennial cool season grasses that provide for site stability, hydrologic function, and biotic integrity of the site.

### State 1.1 Reference State

The Reference State consists of two plant communities: the Wyoming Big Sagebrush/Rhizomatous Wheatgrass Community (1.1), and the Rhizomatous Wheatgrass Community (1.2). Each community differs in percent composition of bunchgrasses, rhizomatous grasses and percent shrub cover. Forbs are a minor component on this site. The percentage of shrub cover is less than 30 percent. The dominant shrub species is Wyoming big sagebrush in the Reference State (1). Two important processes that occur result in plant community changes within the Reference State: sagebrush-killing disturbances (fire, browse, insects, drought, flood) and time without those disturbances, generally referred to as “natural succession.”

**Characteristics and indicators.** The shift from the Rhizomatous Wheatgrass Plant Community (1.2) to the Wyoming Big Sagebrush/Rhizomatous Wheatgrass Plant Community (1.1) is dependent upon an increase of shrub cover. Without sagebrush-killing disturbance, shrubs will increase on this ecological site even with proper grazing management. Improper grazing management may accelerate the rate of increase for shrub species. The shift from the Wyoming Big Sagebrush/Rhizomatous Wheatgrass to the Rhizomatous Wheatgrass Plant Community is dependent upon sagebrush-killing disturbances such as fire, drought, flood, browse, and insects. Management actions can and are often used to mimic these processes through mechanical and chemical treatments. Prescribed fire is not often used on this site due to current land management, lack of fine fuels, and inadequate burn windows (Clause and Randall 2014).

**Resilience management.** The Clayey BRV ecological site has moderate resilience due to its xeric soil moisture regime and frigid temperature regime. Precipitation is typically adequate and more effective with cooler temperatures, but timing of precipitation lowers resilience. Moisture is often not present when needed to support recovery efforts. The site can usually recover after disturbance, but is susceptible to delays in recovery during extreme climatic events such as drought. The site has moderately low resistance to invasion by annual grasses because of climate suitability. Winter precipitation patterns favor annual invasion while cooler temperatures provide

some resistance. The site is susceptible to invasion during hotter climatic periods.

### Dominant plant species

- Wyoming big sagebrush (*Artemisia tridentata ssp. wyomingensis*), shrub
- western wheatgrass (*Pascopyrum smithii*), grass

### Dominant resource concerns

- Terrestrial habitat for wildlife and invertebrates
- Inadequate livestock water quantity, quality, and distribution

## Community 1.1.1

### Big Sagebrush/Rhizomatous Wheatgrass Plant Community

The Big Sagebrush/Rhizomatous Wheatgrass Plant Community is well adapted to Eastern Idaho Plateaus climatic conditions. The diversity in plant species allows for drought tolerance, and natural plant mortality is very low. These plants have strong, healthy root systems that allow production to increase significantly with favorable moisture conditions. Abundant plant litter is available for soil building and moisture retention. Plant litter is properly distributed with very little movement off-site. This plant community provides for soil stability and a properly functioning hydrologic cycle. The soils associated with this site are fertile and hold moderately large amounts of soil moisture, providing a very favorable soil-water-plant relationship. However, heavy soil surface textures result in slightly higher runoff, less infiltration, and hence lower productivity than the Loamy site. Chemical treatment of shrubs has replaced natural sagebrush killing events on many sites in the area. However, chemical treatments impact non-target species, particularly broad-leafed species (forbs and shrubs) differently than natural events such as drought or fire. Where fire tends to result in a short-term increase in forbs, some chemical treatments result in a short-term (or medium-term) reduction in forb density and diversity. The Big Sagebrush/Bunchgrass Community (1.1.1) can occur across the entire ecological site or can occur in a mosaic. This community can occur over time without these disturbances and accelerated with added herbaceous grazing pressure. Wyoming and basin big sagebrush are dominant with mountain big sagebrush at the upper end of the precipitation range for this site. Sagebrush canopy cover ranges from 10 to 20 percent. At this sagebrush canopy level in this precipitation zone, there is little competition between the shrub over-story and the herbaceous under-story (Winward, 2007). A Big Sagebrush/Bunchgrass Community with a degraded under-story is an “at-risk” community, particularly when occurring homogeneously across the landscape. In the Big Sagebrush/Bunchgrass Community (1.1.1), there are generally few canopy gaps, and most basal gaps are small (1-2 feet). Rock cover on the soil surface is essentially nonexistent. Many plant inter-spaces have canopy or litter cover. Production of grasses is much lower than in the Bunchgrass Community (1.1.3) and slightly lower than in the Bunchgrass/Big Sagebrush Community (1.1.2).

Table 5. Annual production by plant type

Plant Type	Low (Kg/Hectare)	Representative Value (Kg/Hectare)	High (Kg/Hectare)
Shrub/Vine	404	538	673
Grass/Grasslike	202	269	336
Forb	67	90	112
<b>Total</b>	<b>673</b>	<b>897</b>	<b>1121</b>

Table 6. Ground cover

Tree foliar cover	0%
Shrub/vine/liana foliar cover	15-25%
Grass/grasslike foliar cover	20-30%
Forb foliar cover	1-5%
Non-vascular plants	0%
Biological crusts	0-1%
Litter	15-40%

Surface fragments >0.25" and <=3"	0-1%
Surface fragments >3"	0-1%
Bedrock	0%
Water	0%
Bare ground	10-20%

**Table 7. Soil surface cover**

Tree basal cover	0%
Shrub/vine/liana basal cover	1-5%
Grass/grasslike basal cover	1-5%
Forb basal cover	0-1%
Non-vascular plants	0%
Biological crusts	0-1%
Litter	45-70%
Surface fragments >0.25" and <=3"	0-10%
Surface fragments >3"	0-5%
Bedrock	0%
Water	0%
Bare ground	10-20%

## Community 1.1.2

### Rhizomatous Wheatgrass Plant Community

Rhizomatous wheatgrasses dominate in the Rhizomatous Wheatgrass Plant Community (1.2) and sagebrush is sub-dominant with foliar cover ranging from one to 10 percent. At this sagebrush canopy level in this precipitation zone, there is no competition between the shrub over-story and the herbaceous under-story. In fact, there is evidence to suggest that the under-story receives more benefit from the sage over-story than negative effects (Winward 2007). There are generally fewer canopy gaps, and basal gaps are generally less than one to two feet. Rock cover on the soil surface is low. Many plant inter-spaces have canopy or litter cover. Production of perennial grasses is higher than in the Wyoming Big Sagebrush/Rhizomatous Wheatgrass Plant Community (1.1), and shrub production is lower with more diversity, including sprouting shrubs.

#### Dominant plant species

- Wyoming big sagebrush (*Artemisia tridentata ssp. wyomingensis*), shrub
- western wheatgrass (*Pascopyrum smithii*), grass

**Table 8. Annual production by plant type**

Plant Type	Low (Kg/Hectare)	Representative Value (Kg/Hectare)	High (Kg/Hectare)
Grass/Grasslike	404	471	673
Shrub/Vine	202	336	336
Forb	67	90	112
<b>Total</b>	<b>673</b>	<b>897</b>	<b>1121</b>

**Table 9. Ground cover**

Tree foliar cover	0%
Shrub/vine/liana foliar cover	5-15%

Grass/grasslike foliar cover	30-40%
Forb foliar cover	1-5%
Non-vascular plants	0%
Biological crusts	0-1%
Litter	15-40%
Surface fragments >0.25" and <=3"	0-1%
Surface fragments >3"	0-1%
Bedrock	0%
Water	0%
Bare ground	10-20%

**Table 10. Soil surface cover**

Tree basal cover	0%
Shrub/vine/liana basal cover	0-1%
Grass/grasslike basal cover	1-5%
Forb basal cover	0-1%
Non-vascular plants	0%
Biological crusts	0-1%
Litter	45-70%
Surface fragments >0.25" and <=3"	0-10%
Surface fragments >3"	0-5%
Bedrock	0%
Water	0%
Bare ground	10-20%

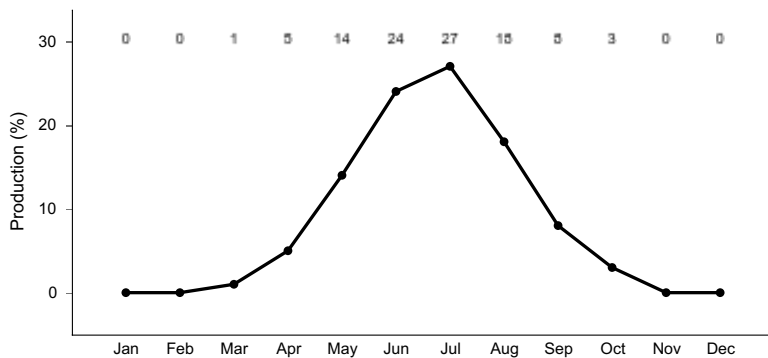

**Figure 9. Plant community growth curve (percent production by month). WY13X01Bu, MLRA 13-Bear River Valley-upland. Forage Production (herbaceous only) Developed by using the Rangeland Analysis Platform (RAP).**

## Pathway P1-2 Community 1.1.1 to 1.1.2

Sagebrush killing event such as moderate intensity fire or climatic events such as severe drought, prolonged soil saturation, freeze-kill, snow mold, and herbivory force the community change. Anthropogenic sagebrush thinning events such as chemical (Tebuthiruron) or mosaic mechanical (mowing, aerator, etc.) can result in a similar pathway in the absence of annual invasives.

**Context dependence.** Killing events are often episodic with climatic events and can occur suddenly with a

particular event (fire, precipitation, temperature, insect irruption, etc.). A successful pathway is contingent upon a grazing regime that allows for periodic critical growth period rest (May-June). An integrated pest management plan is needed to prevent, avoid, manage, and suppress invasive species.

### Conservation practices

Brush Management
Prescribed Grazing

### Pathway P2-1

#### Community 1.1.2 to 1.1.1

Natural succession (time without sagebrush killing event).

**Context dependence.** Time period for pathway is dependent upon weather events such as drought and above normal precipitation years. Drought results in slower pathway while favorable precipitation can result in a faster pathway. A grazing regime that mimics the historic regime (light intensity, episodic grazing events) will not alter the pathway, but a continuous grazing regime at moderate to heavy intensity can accelerate the pathway.

### State 1.2

#### Disturbed State

The Disturbed State is a result of soil-disturbing activities outside of the normal disturbance regime expected for this site. Examples are high intensity hoof action, anthropogenic activity, rodent activity, or frequent flooding, which includes occasional irrigation. It may also occur after brush management preceded or followed by improper grazing techniques that include high-intensity grazing use without appropriate recovery periods. Brush management treatment methods include mechanical (heavy equipment/construction or a mowing/chaining/harrow type sage treatment), chemical (2,4-D or Tebuthion), or biological (browse or insects). Fire could be a factor in maintaining this plant community by stimulating sprouting shrubs (rabbitbrush) and killing sagebrush. Removal of shrubs without proper grazing management can lead to an increase in bare ground and erosion of the upper soil horizon. Consequences of this are decreased soil organic matter and soil erosion, soil crusting, and a decrease in soil surface aggregate stability.

**Characteristics and indicators.** There is a shift toward sprouting shrub dominance or co-dominance with big sagebrush depending on how long it has been since the disturbance(s). Both green (aka yellow in USDA PLANTS) and rubber rabbitbrush may be present. Along with a shift in shrub species, the herbaceous under-story also shifts toward more disturbance tolerant species such as western wheatgrass. Annual weeds such as bur buttercup, flaxweed, and lambsquarter, and invasive annual grasses such as cheatgrass are often present in small amounts (less than 5 percent composition by dry weight).

**Resilience management.** Site resilience is lower than the Reference State, but slightly higher than the Invaded State. Site hydrology has been modified resulting in greater runoff during spring melt and rainfall events. Therefore, the site is drier and unable to recover as quickly after a disturbance. However, sprouting shrubs and remnant perennial vegetation provide some amount of resiliency. Site resistance to invasion by annual grasses is lost due to niches in the under-story for establishment as well as site water availability during the time suited for winter annuals such as cheatgrass (*Bromus tectorum*). Episodic and limited moisture is more suited to annual life forms.

#### Dominant plant species

- yellow rabbitbrush (*Chrysothamnus viscidiflorus*), shrub
- Wyoming big sagebrush (*Artemisia tridentata* ssp. *wyomingensis*), shrub
- western wheatgrass (*Pascopyrum smithii*), grass
- cheatgrass (*Bromus tectorum*), grass

#### Dominant resource concerns

- Sheet and rill erosion
- Classic gully erosion
- Plant productivity and health

- Plant structure and composition
- Plant pest pressure
- Terrestrial habitat for wildlife and invertebrates
- Feed and forage imbalance
- Inadequate livestock water quantity, quality, and distribution

### **Community 1.2.1**

#### **Big Sagebrush/Rabbitbrush Plant Community**

This plant community is a result of recovery after a past soil-disturbing activity. It is co-dominated by sprouting shrubs, mainly green rabbitbrush (aka yellow rabbitbrush in USDA PLANTS) and Wyoming big sagebrush. The understory typically consists of a combination of perennial rhizomatous grasses, mainly western wheatgrass, and annual grasses and forbs. Total annual production ranges from 400 to 800 pounds per acre (lbs/ac) with a RV of 600 lbs/ac. The soil is typically adequately protected, but erosion can occur during high runoff events. The biotic integrity is reduced due to low vegetative production, relative dominance and unexpected structural/functional groups, and potentially invasive species if present. The watershed is functioning-at-risk.

### **Community 1.2.2**

#### **Rabbitbrush/Rhizomatous Wheatgrass Plant Community**

This plant community is the result of a recent soil-disturbing activity. Western wheatgrass is the dominant perennial grass, and annual grasses and forbs are often present. With sagebrush removed, green rabbitbrush (aka yellow rabbitbrush in USDA PLANTS) is the dominant shrub, often exceeding 10 percent of the annual production. Subdominant under-story species include bottlebrush squirreltail, Sandberg bluegrass, and unpalatable annual and perennial forbs. In the absence of annuals, there can be a substantial amount of bare ground. Total annual production ranges from 400 to 800 lbs/ac with a RV of 600 lbs/ac. The soil is not adequately protected, and erosion is expected without management to allow for adequate litter and residual. The biotic integrity is reduced due to low vegetative production, relative dominance and unexpected structural/functional groups, and potentially invasive species if present. The watershed is functioning-at-risk.

### **Pathway P1-2**

#### **Community 1.2.1 to 1.2.2**

Sagebrush killing event, typically high intensity fire or consecutive anthropogenic sagebrush treatments such as chemical (Tebuthiuron) or mechanical (mowing, aerator, etc.).

**Context dependence.** Killing events are often episodic with climatic events and can occur suddenly with a particular event (fire, precipitation, temperature, insect irruption, etc.). If extreme conditions/disturbances such as hot temperatures, drought, or high intensity grazing occur, there is risk of a transition to the Invaded State depending upon severity and cumulative disturbance.

#### **Conservation practices**

Brush Management
------------------

### **Pathway P2-1**

#### **Community 1.2.2 to 1.2.1**

Natural succession (time without sagebrush killing event).

**Context dependence.** Time period for pathway is dependent upon weather events such as drought and above normal precipitation years. Drought results in slower pathway while favorable precipitation can result in a faster pathway. A grazing regime that mimics the historic regime (light intensity, episodic grazing events) will not alter the pathway, but a continuous grazing regime at moderate to heavy intensity can accelerate the pathway.

### **State 1.3**

#### **Invaded State**

The Invaded State occurs once perennial grasses are reduced and the site is invaded by annual grasses and forbs. It often occurs in conjunction with severe grazing intensity and drought conditions.

**Characteristics and indicators.** In the Invaded State, sagebrush canopy varies, but the under-story is dominated by annual invasive and weedy species. There will be indicators of reduced soil and site stability as well as reduced hydrologic function, mainly water flow patterns and pedestals, but rills and gullies are likely. Compaction is likely, as well as soil surface loss and degradation. Biotic integrity is affected by functional/structural groups not expected for the site, invasive plants, and the loss of perennial species and functional/structural groups. The site is more prone to drought with large fluctuations in annual production in response to weather events. The site is less diverse with lower quality habitat for wildlife and pollinators, and the risk of wildfire is increased from fine fuel production.

**Resilience management.** Site resilience is lower than all other states because the site hydrology has been modified resulting in greater runoff during spring melt and rainfall events. Therefore, the site is drier and unable to recover as quickly after a disturbance. Site resistance to invasion by annual grasses is lost due to niches in the under-story for establishment as well as site water availability during the time suited for winter annuals such as cheatgrass (*Bromus tectorum*). Episodic and limited moisture is more suited to annual life forms.

#### **Dominant plant species**

- Wyoming big sagebrush (*Artemisia tridentata* ssp. *wyomingensis*), shrub
- cheatgrass (*Bromus tectorum*), grass

#### **Dominant resource concerns**

- Sheet and rill erosion
- Classic gully erosion
- Plant productivity and health
- Plant structure and composition
- Plant pest pressure
- Terrestrial habitat for wildlife and invertebrates
- Feed and forage imbalance
- Inadequate livestock water quantity, quality, and distribution

### **Community 1.3.1**

#### **Big Sagebrush/Annual Plant Community**

This plant community is the result of improper grazing. Improper grazing is defined as either high- or low-intensity grazing without the appropriate recovery period. Wyoming big sagebrush dominates with annual production often exceeding 40 percent. The under-story is dominated by annual grasses and forbs while perennial grass and forbs are sparse and bunchgrasses are limited to the protected areas under shrubs. The predominant perennial grasses include Sandberg bluegrass and rhizomatous wheatgrass (western wheatgrass). Total annual production ranges from 300 to 700 lbs/ac with a RV of 500 lbs/ac. Soil erosion is accelerated because of the lack of deep-rooted perennials. The biotic community has been compromised. The watershed is degraded. Water flow patterns and pedestals are obvious. Infiltration is reduced, and runoff is increased.

#### **Dominant plant species**

- Wyoming big sagebrush (*Artemisia tridentata* ssp. *wyomingensis*), shrub
- cheatgrass (*Bromus tectorum*), grass

### **Community 1.3.2**

#### **Annual Plant Community**

This plant community results from a severe sagebrush killing disturbance once a site has been invaded by annuals. Repeated disturbances, such as fire, can maintain this plant community, but that is a rare occurrence for this site. Otherwise, sagebrush will typically re-establish on this site fairly quickly, within 5 to 10 years. However, to achieve pre-disturbance sagebrush canopy levels will take much longer. This site has low potential for recovery once dominated by annuals. Seeding is recommended to restore herbaceous perennial functional structural groups. Productivity in this plant community phase is highly variable based on current year's weather. Total annual

production ranges from 300 to 700 lbs/ac with a RV of 500 lbs/ac.

### **Dominant plant species**

- cheatgrass (*Bromus tectorum*), grass

### **Pathway P1-2**

#### **Community 1.3.1 to 1.3.2**

Sagebrush killing event, typically catastrophic fire or mechanical sagebrush treatments (mowing, aerator, disking, etc.)

**Context dependence.** Killing events are often episodic with climatic events and can occur suddenly with a particular event (fire, precipitation, temperature, insect irruption, etc.). Consecutive disturbances and extreme conditions such as hot temperatures, drought, or high intensity grazing will exacerbate this pathway to an annual dominated system.

### **Conservation practices**

Brush Management

### **Pathway P2-1**

#### **Community 1.3.2 to 1.3.1**

Natural succession (time without sagebrush killing event).

**Context dependence.** Time period for pathway is dependent upon weather events such as drought and above normal precipitation years. Drought results in slower pathway while favorable precipitation can result in a faster pathway. A grazing regime that mimics the historic regime (light intensity, episodic grazing events) will not alter the pathway, but a continuous grazing regime at moderate to heavy intensity can accelerate the pathway.

### **Transition T1-2**

#### **State 1.1 to 1.2**

Soil-disturbance outside of the normal disturbance regime expected for this site is the main mechanism for transition. Examples include fire, high intensity hoof action, anthropogenic activity (e.g. mechanical or chemical treatments), rodent activity, or frequent flooding, which includes occasional irrigation.

**Constraints to recovery.** Recovery is inhibited by consecutive disturbances over a relatively short time period and drought conditions. Annual grasses are likely in small amounts, increasing with each additional disturbance.

**Context dependence.** Drought and annual invasion are most likely variables to prevent restoration.

### **Transition T1-3**

#### **State 1.1 to 1.3**

Extreme disturbance, including catastrophic fire, drought, or other soil removal disturbance, resulting in removal of perennial vegetation followed by annual invasion, typically associated with post-drought conditions, results in the Annual Plant Community.

**Constraints to recovery.** Recovery is inhibited by fire risk and annual invasion.

**Context dependence.** Drought and annual invasion are variables that prevent restoration.

### **Transition T2-3**

#### **State 1.2 to 1.3**

The driver is extreme herbivory resulting in removal of perennial herbaceous vegetation followed by annual



invasion, typically associated with post-drought conditions. It is common for this to occur without a sagebrush killing event, resulting in the shrub/annual plant community.

**Constraints to recovery.** Recovery is inhibited by fire risk and annual invasion.

**Context dependence.** Drought and annual invasion are variables that prevent restoration.

## Land use 2 Pastureland

This is a moderately deep to deep site with very few limitations for agriculture production, and therefore is often converted to irrigated pasture due to high water holding capacity, low slopes, and landscape position that lends itself to tillage and irrigation practices. The site is also converted to dryland pasture to a lesser extent. Pastureland is land composed of introduced or domesticated native forage species that is used primarily for the production of livestock. Pastures receive periodic renovation and cultural treatments, such as tillage, fertilization, mowing, weed control, and may be irrigated. Pastures are not in rotation with crops.

**Characteristics and indicators.** Pasture on this site can be either dryland or irrigated. Irrigated pasture was often historically tilled and irrigation infrastructure installed. Perennial forage species such as Kentucky bluegrass, smooth brome, and white or alsike clover were often seeded historically. In more recent times, creeping meadow foxtail was introduced to the Bear River Valley, and has taken over many flood irrigated pastures. Irrigated pasture is maintained through irrigation, dragging, grazing and occasional haying practices. Hay production with aftermath grazing is common, but pastures on this site can also managed for grazing throughout the growing season with some dormant season grazing as well. Dryland pasture was often historically tilled and planted to crested wheatgrass and has maintained itself over time with minimal inputs such as mowing, disking, dragging, or harrowing. Occasional haying on dryland pasture typically occurs only in the wettest years.

### State 2.1 Irrigated Pasture State

See Clayey Forage Suitability Group (FSG) for MLRA 34A LRU F (10-14" ppt, 70-90 day growing season) for more information at Wyoming's electronic Field Office Technical Guide, Section II, Forage Suitability Groups [https://efotg.sc.egov.usda.gov/references/public/WY/mlra34A\\_fsg\\_clayey\\_lru\\_f\\_.pdf](https://efotg.sc.egov.usda.gov/references/public/WY/mlra34A_fsg_clayey_lru_f_.pdf) This FSG covers moderately deep to deep soils with clay loam or heavier soil textures and greater than 6 inches available water-holding capacity (AWC) in the top 60 inches of the soil profile. Production expected to range from 2,000 to 4,000 lbs./ac. with representative value (RV) of 3,000 lbs./ac. Adapted species for use as irrigated pasture include native species such as Idaho fescue, prairie junegrass, Canby's bluegrass, blue wildrye, slender wheatgrass, western wheatgrass, and tufted hairgrass; introduced species including meadow brome, timothy, orchardgrass, beardless wildrye, Altai wildrye, red fescue, sheep fescue, and tall fescue, creeping meadow foxtail, Canada bluegrass, and Kentucky bluegrass; forb and shrub species such as cicer milkvetch, birdsfoot trefoil, small burnett, white clover, alsike clover, red clover, and strawberry clover. Selection of species should be based on production goals and intended use (goals and objectives). More information regarding preferred varieties for irrigated pasture can be found at <http://animalrange.montana.edu/documents/extension/mteb99.pdf> AND [https://www.nrcs.usda.gov/Internet/FSE\\_PLANTMATERIALS/publications/mtpmctn10704.pdf](https://www.nrcs.usda.gov/Internet/FSE_PLANTMATERIALS/publications/mtpmctn10704.pdf)

**Characteristics and indicators.** Irrigated pasture on this site varies from a very diverse mix of native wetland plants to a monoculture of creeping meadow foxtail. Flood irrigation water management often results in hydric soil and hydrophytic vegetation.

**Resilience management.** Resilience on this site when in irrigated pasture is much higher than reference state. Resistance to annual invasion is typically much higher than the reference state. However, improper grazing or irrigation water management techniques could result in noxious weed invasion by perennials such as perennial pepperweed, musk thistle, Canada thistle, or scentless chamomile.

#### Dominant plant species

- creeping meadow foxtail (*Alopecurus arundinaceus*), grass

#### Dominant resource concerns

- Compaction
- Inefficient irrigation water use
- Plant productivity and health
- Terrestrial habitat for wildlife and invertebrates

## State 2.2

### Dryland Pasture State

See Clayey Forage Suitability Group (FSG) for MLRA 34A LRU F (10-14" ppt, 70-90 day growing season) for more information at Wyoming's electronic Field Office Technical Guide, Section II, Forage Suitability Groups [https://efotg.sc.egov.usda.gov/references/public/WY/mlra34A\\_fsg\\_clayey\\_lru\\_f\\_.pdf](https://efotg.sc.egov.usda.gov/references/public/WY/mlra34A_fsg_clayey_lru_f_.pdf) This FSG covers moderately deep to deep soils with clay loam or heavier soil textures and greater than 6 inches available water-holding capacity (AWC) in the top 60 inches of the soil profile. Production expected to range from 600 to 1,000 lbs./ac. with representative value (RV) of 800 lbs./ac. Adapted species for use as dryland pasture include native species such as Indian ricegrass, big bluegrass, basin wildrye, slender wheatgrass, and western wheatgrass; introduced species including crested wheatgrass, Russian wildrye, sheep fescue, and intermediate or pubescent wheatgrass; and forb and shrub species such as dryland alfalfa, sweetclover, forage kochia, winterfat, and four-wing saltbush. Selection of species should be based on production goals and intended use (goals and objectives). More information regarding adapted species for dryland can be found at [https://www.nrcs.usda.gov/Internet/FSE\\_PLANTMATERIALS/publications/mtpmspu1138.pdf](https://www.nrcs.usda.gov/Internet/FSE_PLANTMATERIALS/publications/mtpmspu1138.pdf)

**Characteristics and indicators.** Dryland pasture on this site is typically dominated by a mono-culture of crested wheatgrass. It is common for sagebrush to re-colonize the site over time without periodic renovation or cultural practices such as mowing or tillage.

**Resilience management.** Resilience on this site when in dryland pasture is similar to the Reference State. However, it may be lower if dominated by a mono-culture that lacks diversity, resulting in a plant community that is vulnerable to drastic changes following disturbance. Resistance to annual invasion is similar to reference, but could be slightly higher if planted to highly competitive species such as crested wheatgrass or Russian wildrye. However, new research from the Great Basin indicates that native seedlings can be as competitive as introduced species (Ott et.al. 2019).

### Dominant plant species

- crested wheatgrass (*Agropyron cristatum*), grass

### Dominant resource concerns

- Sheet and rill erosion
- Classic gully erosion
- Compaction
- Organic matter depletion
- Plant productivity and health
- Plant structure and composition
- Terrestrial habitat for wildlife and invertebrates
- Inadequate livestock water quantity, quality, and distribution

## Transition T1-2

### State 2.1 to 2.2

Irrigation abandonment results in transition from irrigated pasture to dryland pasture.

## Land use 3

### Cropland

This is a moderately deep to deep site with very few limitations for agriculture production, and therefore is often converted to irrigated crop due to high water holding capacity, low slopes, and landscape position that lends itself to tillage and irrigation practices. Cropland is land used primarily for the production and harvest of annual or perennial field, forage, food, fiber, horticultural, orchard, vineyard, or energy crops.

**Characteristics and indicators.** Cropland on this site is typically irrigated. Irrigated crop is typically perennial and consists of a mixture of legume (alfalfa or clover) and a variety of cool-season perennial forage grasses in rotation with short-season annual cereal grains such as barley. The annual portion of the crop rotation is often grown as a forage (not cash) crop.

### **State 3.1 Irrigated Crop State**

See Clayey Forage Suitability Group (FSG) for MLRA 34A LRU F (10-14" ppt, 70-90 day growing season) for more information at Wyoming's electronic Field Office Technical Guide, Section II, Forage Suitability Groups [https://efotg.sc.egov.usda.gov/references/public/WY/mlra34A\\_fsg\\_clayey\\_lru\\_f\\_.pdf](https://efotg.sc.egov.usda.gov/references/public/WY/mlra34A_fsg_clayey_lru_f_.pdf) This FSG covers moderately deep to deep soils with clay loam or heavier soil textures and greater than 6 inches available water-holding capacity (AWC) in the top 60 inches of the soil profile. Production expected to range from 2,000 to 4,000 lbs./ac. with representative value (RV) of 3,000 lbs./ac. The most common crop rotation on this site is one to three years of annual grains with 7 to 9 years of perennial forage/hay crop. Adapted species for use as annual irrigated crop include short-season grains such as barley grown for forage or cash grain crop. Adapted species for use as perennial irrigated crop (hayland) include legumes such as alfalfa, clovers, sainfoin, cicer milkvetch, and birds foot trefoil; introduced species including meadow brome, timothy, and orchardgrass.

**Characteristics and indicators.** Irrigated crop on this site is varies from annual to perennial forage. Center pivot or side roll sprinklers are the most common form of irrigation, however improved flood irrigation such as graded borders also occurs.

**Resilience management.** Resilience on this site when in irrigated crop is typically high due to added irrigation water. Resistance to annual invasion is typically high as well. However, severe ground disturbance, improper aftermath grazing or irrigation water management techniques could result in noxious weed invasion by perennials such as perennial pepperweed, musk thistle, Canada thistle, or scentless chamomile.

#### **Dominant resource concerns**

- Sheet and rill erosion
- Ephemeral gully erosion
- Compaction
- Organic matter depletion
- Inefficient irrigation water use
- Plant productivity and health
- Terrestrial habitat for wildlife and invertebrates
- Energy efficiency of equipment and facilities
- Energy efficiency of farming/ranching practices and field operations

### **Conversion C1-2 Land use 1 to 2**

Most range conversion to pasture occurred at the end of the 19th century and was done using horse-pulled implements and hand tools. Flood irrigation infrastructure was installed and introduced species seeded such as Kentucky bluegrass and clover. Wild flood irrigation is the most common with little control and sometimes water is checked at the bottom of fields to backup water and promote extended flooded conditions that result in more hydrophytic vegetation and hydric soil development.

### **Conversion C1-3 Land use 1 to 3**

Most range conversion to crop occurred at the end of the 19th century and was done using horse-pulled implements and hand tools. Flood irrigation infrastructure such as graded borders were installed and introduced species seeded such as smooth brome and alfalfa in rotation with annual cereal grains such as oats and barley. The water source is surface water from the Bear River. In recent times there have been some range conversion to crop using sprinkler irrigation to improve water efficiency and control plus reduce labor. Higher value forage grasses such as meadow

brome and non-bloat legumes such as sainfoin and cicer milkvetch have also been introduced into the crop rotation.

## Conversion C2-3 Land use 2 to 3

In more recent times, wild flood irrigation is being converted to crop under sprinkler irrigation, resulting in the ability to grow higher value forages and legumes in rotation with annual cereal grains such as oats and barley.

### Additional community tables

Table 11. Community 1.2 plant community composition

Group	Common Name	Symbol	Scientific Name	Annual Production (Kg/Hectare)	Foliar Cover (%)
<b>Grass/Grasslike</b>					
1	<b>PERENNIAL MID-SIZE COOL SEASON GRASSES</b>			45–135	
	Indian ricegrass	ACHY	<i>Achnatherum hymenoides</i>	45–90	5–20
	squirreltail	ELEL5	<i>Elymus elymoides</i>	45–90	5–10
	muttongrass	POFE	<i>Poa fendleriana</i>	0–45	0–10
	bluebunch wheatgrass	PSSP6	<i>Pseudoroegneria spicata</i>	0–45	0–5
	slender wheatgrass	ELTR7	<i>Elymus trachycaulus</i>	0–45	0–5
	needle and thread	HECO26	<i>Hesperostipa comata</i>	0–45	0–5
	prairie Junegrass	KOMA	<i>Koeleria macrantha</i>	0–45	0–5
	Sandberg bluegrass	POSE	<i>Poa secunda</i>	0–45	0–5
2	<b>RHIZOMATOUS GRASSES</b>			112–314	
	thickspike wheatgrass	ELLAL	<i>Elymus lanceolatus</i> ssp. <i>lanceolatus</i>	135–314	10–20
	western wheatgrass	PASM	<i>Pascopyrum smithii</i>	135–314	10–20
3	<b>MISC. GRASSES/GRASSLIKES</b>			34–90	
	Sandberg bluegrass	POSE	<i>Poa secunda</i>	9–90	1–10
	plains reedgrass	CAMO	<i>Calamagrostis montanensis</i>	0–45	0–5
	needleleaf sedge	CADU6	<i>Carex duriuscula</i>	0–45	0–5
<b>Forb</b>					
4	<b>PERENNIAL FORBS</b>			34–81	
	buckwheat	ERIOG	<i>Eriogonum</i>	9–45	1–5
	lupine	LUPIN	<i>Lupinus</i>	0–45	0–5
	spiny phlox	PHHO	<i>Phlox hoodii</i>	9–45	1–5
	aster	SYMPH4	<i>Symphyotrichum</i>	0–45	0–5
	ragwort	SENEC	<i>Senecio</i>	0–27	0–3
	scarlet globemallow	SPCO	<i>Sphaeralcea coccinea</i>	0–27	0–3
	Munro's globemallow	SPMU2	<i>Sphaeralcea munroana</i>	0–27	0–3
	stemless mock goldenweed	STAC	<i>Stenotus acaulis</i>	0–27	0–3
	longleaf phlox	PHLO2	<i>Phlox longifolia</i>	0–27	0–3
	flaxleaf plainsmustard	SCLI	<i>Schoenocrambe linifolia</i>	0–27	0–3
	tapertip hawksbeard	CRAC2	<i>Crepis acuminata</i>	0–27	0–3
	fleabane	ERIGE2	<i>Erigeron</i>	0–27	0–3
	beardtongue	PENST	<i>Penstemon</i>	0–27	0–3
	hoop-pine	MACA2	<i>Meibomia</i>	0–27	0–3

	Hoary tansyaster	MACAZ	<i>Macraeranthura canescens</i>	0-27	0-3
	bluebells	MERTE	<i>Mertensia</i>	0-27	0-3
	western yarrow	ACMIO	<i>Achillea millefolium</i> var. <i>occidentalis</i>	0-27	0-3
	agoseris	AGOSE	<i>Agoseris</i>	0-27	0-3
	pussytoes	ANTEN	<i>Antennaria</i>	0-27	0-3
	milkvetch	ASTRA	<i>Astragalus</i>	0-27	0-3
	Indian paintbrush	CASTI2	<i>Castilleja</i>	0-9	0-1
	pale bastard toadflax	COUMP	<i>Comandra umbellata</i> ssp. <i>pallida</i>	0-9	0-1
	rockcress	ARABI2	<i>Arabis</i>	0-9	0-1
	sandwort	ARENA	<i>Arenaria</i>	0-9	0-1
	onion	ALLIU	<i>Allium</i>	0-9	0-1
	locoweed	OXYTR	<i>Oxytropis</i>	0-9	0-1
	western wallflower	ERAS2	<i>Erysimum asperum</i>	0-9	0-1
	desertparsley	LOMAT	<i>Lomatium</i>	0-9	0-1
	povertyweed	IVAX	<i>Iva axillaris</i>	0-9	0-1
	cryptantha	CRYPT	<i>Cryptantha</i>	0-9	0-1
	larkspur	DELPH	<i>Delphinium</i>	0-9	0-1
	stonecrop	SEDUM	<i>Sedum</i>	0-9	0-1
	sagebrush buttercup	RAGL	<i>Ranunculus glaberrimus</i>	0-9	0-1
	hollyleaf clover	TRGY	<i>Trifolium gymnocarpon</i>	0-9	0-1
	clover	TRIFO	<i>Trifolium</i>	0-9	0-1
	violet	VIOLA	<i>Viola</i>	0-9	0-1
	deathcamas	ZIGAD	<i>Zigadenus</i>	0-9	0-1
5	<b>ANNUAL FORBS</b>			0-9	
	rockjasmine	ANDRO3	<i>Androsace</i>	0-9	0-1
	bushy bird's beak	CORA5	<i>Cordylanthus ramosus</i>	0-9	0-1
<b>Shrub/Vine</b>					
6	<b>SAGEBRUSH</b>			78-224	
	Wyoming big sagebrush	ARTRW8	<i>Artemisia tridentata</i> ssp. <i>wyomingensis</i>	179-224	5-15
	basin big sagebrush	ARTRT	<i>Artemisia tridentata</i> ssp. <i>tridentata</i>	0-224	0-5
	little sagebrush	ARARL	<i>Artemisia arbuscula</i> ssp. <i>longiloba</i>	0-45	0-5
7	<b>MISC. SHRUBS</b>			11-45	
	Gardner's saltbush	ATGA	<i>Atriplex gardneri</i>	0-45	0-5
	yellow rabbitbrush	CHVI8	<i>Chrysothamnus viscidiflorus</i>	9-45	1-5
	winterfat	KRLA2	<i>Krascheninnikovia lanata</i>	0-45	0-5
	greasewood	SAVE4	<i>Sarcobatus vermiculatus</i>	0-45	0-5
	spineless horsebrush	TECA2	<i>Tetradymia canescens</i>	0-27	0-3
	shortspine horsebrush	TESP2	<i>Tetradymia spinosa</i>	0-27	0-3
	granite prickly phlox	LIPU11	<i>Linanthus pungens</i>	0-27	0-3
	rubber rabbitbrush	ERNA10	<i>Ericameria nauseosa</i>	0-27	0-3
	plains pricklypear	OPPO	<i>Opuntia polyacantha</i>	0-9	0-1
	bud sagebrush	PIDE4	<i>Picrothamnus desertorum</i>	0-9	0-1

## Animal community

The following table lists suggested stocking rates for cattle under continuous season-long grazing under normal growing conditions with a harvest efficiency (HE) of 25 percent. These are conservative estimates that should be used only as guidelines in the initial stages of the conservation planning process. Often, the current plant composition does not entirely match any particular plant community (as described in this ecological site description). A field visit is required to document actual plant composition and production. More precise carrying capacity estimates, considering forage preference and accessibility (slope, distance to water, etc.), should be calculated using this information, particularly when grazers other than cattle are involved. Under more intensive grazing management, improved harvest efficiencies (up to 35 percent) can result in an increased carrying capacity, but recovery time for upland sites is much longer. In general, intake declines as forage availability decreased and should be considered when determining HE. If distribution problems occur, stocking rates should be reduced or facilitating conservation practices (i.e., cross-fencing, water development) implemented to maintain plant health and vigor.

Stocking rates are expressed in Animal Unit Months (AUMs) which is defined as the amount of forage consumed by a 1,000 pound cow with a less than 4 month old calf at her side.

Plant Community	Production (lbs./ac.)	Initial Suggested Stocking Rate (AUMs/ac.)*	Ac./AUM
1.1 Big Sagebrush/Rhizomatous Wheatgrass	600-800-1000	0.08	13
1.2 Rhizomatous Wheatgrass	600-800-1000	0.12	8
2.1 Big Sagebrush/Rabbitbrush	400-600-800	0.07	14
2.2 Rabbitbrush/Rhizomatous Wheatgrass	400-600-800	0.08	13
3.1 Big Sagebrush/Annual	300-500-700	0.05	20
3.2 Annual	300-500-700	0.05	20
Irrigated Pasture	2000-3000-4000	0.82	1.2
Dryland Pasture	600-800-1000	0.22	5

\* Continuous, season-long grazing by cattle under average growing conditions.

Calculation for stocking rates are as follows: Using RV values for production, take forage palatable to grazing cattle and multiply by 0.25 HE and divide by 912.5 lbs./AUM air-dry weight (ADW) to arrive at the initial suggested stocking rate in AUMs/acre.

Not all kinds of livestock or wildlife have the same forage demand as a 1000-pound lactating cow. In addition, forage demand varies within a species depending on its class, i.e., its growth rate (e.g. heifers and steers vs. mature cow), lactating and maintenance (e.g., dry cow vs cow with calf). For this reason, animal unit equivalents (AUE) are provided in the National Range & Pasture Handbook to assist with this approximate determination of forage demand based on the kind, class and size of animal (NRPH, 2003). For cattle with a different average weight than a 1000 pound average, AUE can be adjusted (i.e., every 100 pounds of animal weight equates to about 0.10 Animals Units thus a 1200-pound cow with a calf would be 1.2 AUE .

Grazing by domestic livestock is one of the major income-producing industries in the area. Rangeland in this area may provide year-long forage for cattle, sheep, or horses. During the dormant period, the forage for livestock must be supplemented with protein because the quality does not meet minimum livestock requirements.

Distance to water, shrub density, and slope can affect grazing capacity within a management unit. Accessibility adjustments should be made for the planning area as necessary. For example, 30 percent of a management unit may have 25 percent slopes and distances of greater than one mile from water, resulting in a 50 percent reduction in grazing access; therefore, the adjustment is calculated for 30 percent of the unit (i.e. 50 percent reduction on 30 percent of the management unit). Fencing, slope length, management, access, terrain, kind and class of livestock, and breeds are all factors that can increase or decrease the percent of grazing access within a management unit. Adjustments should be made that incorporate these factors when calculating the carrying capacity of a management unit.

### Wildlife Interpretations:

Sagebrush grassland habitats are critically important for wildlife. The LRU provides crucial winter range for mule deer, elk, pronghorn and moose. Portions of the LRU fall within overlapping crucial winter range delineated for three

species of big game. Nearly all of the LRU in Wyoming supports a designated migration corridor and numerous associated stopover habitats, where thousands of mule deer from the Wyoming Range Herd Unit move north and south between summer and winter ranges. Healthy vegetative communities within migration stopover areas are extremely important as forage and cover where mule deer may spend several days resting and feeding to refuel before moving again. The middle segment of the LRU (east and west of the Bear River) is within sage grouse core habitat, providing breeding leks, nesting, early brood rearing, late brood rearing, and winter habitats. Maintaining intact high quality sagebrush grassland habitats with a diversity of successional stages is vitally important for meeting the needs of wildlife using this landscape.

#### Wildlife Habitat Threats:

Winter moisture characteristics of the BRV LRU promote environmental conditions ideal for cheatgrass establishment and persistence. Cheatgrass presence is increasing and competing with native perennial grasses and forbs to deteriorate habitat function for big game, sage grouse and other sagebrush obligate wildlife. Advanced cheatgrass invasion is expected to alter fire regimes to a shorter fire return interval outside the natural range of variability, where sagebrush stands burn frequently resulting in a reduction of browse and cover availability for wildlife. Eventually, shrub cover dominance could revert to green (aka yellow rabbitbrush in USDA PLANTS) or rubber rabbitbrush, significantly impacting wildlife dependent on sagebrush in this landscape for survival. Current and future anthropogenic impacts to sagebrush grasslands include agriculture expansion, energy development, water storage projects, and subdivision/residential development. Increasing demand for expanding private lands hay production has seen conversion of sagebrush stands in and near sage grouse core habitat to center pivot sprinkler irrigation. Sage grouse may use these new fields during the late brood rearing period, but there is a loss of important sagebrush cover for escape, lekking, nesting, and winter cover/forage as critical life stage habitat needs for sage grouse. Energy transmission projects have recently created interest and opportunities for solar farm development in the LRU. These solar energy projects could permanently convert site specific sagebrush-grassland habitat to industrial development locations with negative cumulative impacts for sage grouse, wintering big game, and other sagebrush dependent wildlife. Aesthetic values of the Cokeville area may attract future demand for small acreage home developments, especially in the Smith's Fork River Valley and Raymond Mountain foothills. Increased fencing and sagebrush removal usually associated with residential development could be extremely detrimental to big game migration and migration stopover habitats.

#### Wildlife Habitat Uses:

The Big Sagebrush/Bunchgrass Plant Community, with shrub canopies ranging from 15-25%, provides transitional and/or crucial winter seasonal habitat for mule deer, elk, pronghorn and sage grouse. The combination of healthy sagebrush and herbaceous vegetation provide adequate escape and thermal cover for mule deer and preferred nesting and early brood rearing habitat for sage grouse. Sagebrush obligate bird species of Brewer's sparrow, sage thrasher, and sage sparrow depend on denser sagebrush canopies (20%) and sagebrush heights of 35-70 cm for foraging, escape cover, and nesting. Pygmy rabbits also prefer dense tall Wyoming and basin big sagebrush stands with deeper soils for burrows at the base of sagebrush plants. Wyoming big sagebrush serves as important browse for deer, elk, and pronghorn during the winter as it stands erect in deep snow, allowing ungulates relatively easy access without pawing and expenditure of energy reserves. Mountain big sagebrush and associated mixed mountain shrub species of true mountain mahogany, serviceberry, and antelope bitterbrush are found at the higher precipitation fringe areas of this zone also provide important winter browse for big game including moose. Associated under-story forbs and grasses are nutritionally important during the spring period for big game coming out of winter, and for fall migration stopover.

The Disturbed State reduces sagebrush as important wildlife cover and browse in exchange for dominance of sprouting green rabbitbrush of a lesser value for wildlife. Diversity and productivity of under-story species diminishes, with loss of bunchgrasses and increases in rhizomatous grasses and annual forbs. This transition negatively affects vertical and horizontal cover, and reduces forage values for several wildlife species, including designated sage grouse core habitat. The Invaded State exhibits sagebrush stand under-stories dominated by invasive annual grasses, particularly cheatgrass. Conversion of native perennial grasses and forbs to cheatgrass is detrimental for maintaining diverse structural cover and nutritional forage. Hiding cover and forage niches for sagebrush obligate songbirds disappears, forb and insect production for young sage grouse chicks is reduced, nutritional value of big game transitional season forage becomes inconsistent or is lost, and mid-size bunchgrass species able to stand up in deep snows as forage for wintering elk are reduced. Short Fire Return Intervals may preclude the re-establishment and persistence of sagebrush stands, negatively affecting all sagebrush dependent wildlife, especially sage grouse core habitat and thousands of migrating and wintering mule deer that use the area.

## Hydrological functions

Water is the principal factor limiting forage production on this site. This site is dominated by soils in hydrologic group

C, with localized areas in hydrologic group D. Infiltration ranges from very slow to moderately slow. Runoff potential for this site varies from moderate to high, depending upon soil hydrologic group and ground cover. In many cases, lesser sloping areas with greater than 75 percent ground cover have the greatest potential for high infiltration and lower runoff. Greater sloping areas where ground cover is less than 50 percent have the greatest potential to have reduced infiltration and higher runoff (refer to Part 630, NRCS National Engineering Handbook for detailed hydrologic information).

Rills and gullies are not typically present. Water flow patterns should be barely distinguishable if at all present. Pedestals are only slightly present in association with bunchgrasses and shrubs. Litter typically falls in place, and signs of movement are not common. Chemical and physical crusts are sometimes present on this site. Biological crusts are present, but only cover 1-2% of the soil surface.

## **Recreational uses**

This site provides hunting opportunities for upland game species. The wide variety of plants which bloom in the spring have an aesthetic value that appeals to recreationists.

## **Inventory data references**

Information presented here has been derived from historic and recent clipping data and other inventory data. Field observations from range trained personnel were also used.

Inventory Data Resources include:

Two historic data sets

## **References**

. 2021 (Date accessed). USDA PLANTS Database. <http://plants.usda.gov>.

. 2021 (Date accessed). USNVC [United States National Vegetation Classification]. 2019. United States National Vegetation Classification Database, V2.03. Federal Geographic Data Committee, Vegetation Subcommittee, Washington DC.. USNVC: <http://usnvc.org/>.

. 2003. National Range and Pasture Handbook (NRPH). United States Department of Agriculture, Natural Resources Conservation Service, Washington, D.C..

Bestelmeyer, B., J.R. Brown, K.M. Havstad, B. Alexander, G. Chavez, and J.E. Herrick. 2003. Development and Use of State and Transition Models for Rangelands. *Journal of Range Management* 56:114–126.

Bestelmeyer, B., J.R. Brown, J.E. Herrick, D.A. Trujillo, and K.M. Havstad. 2004. Land Management in the American Southwest: a state-and-transition approach to ecosystem complexity. *Environmental Management* 34:38–51.

Bestelmeyer, B. and J. Brown. 2005. State-and-Transition Models 101: A Fresh look at vegetation change.

Bestelmeyer, B.T., K. Moseley, P.L. Shaver, H. Sanchez, D.D. Briske, and M.E. Fernandez-Gimenez. 2010. Practical guidance for developing state-and-transition models. *Rangelands* 32:23–30.

Bonnin, G.M., D. Martin, T. Lin, M. Parzybok, M. Yekta, and D. Riley. 2011 (Date accessed). "Precipitation-Frequency Atlas of the United States" NOAA Atlas 14, Volume 1 Version 5.0. <https://hdsc.nws.noaa.gov/hdsc/pfds/>.



Briske, D.D., B.T. Bestelmeyer, T.K. Stringham, and P.L. Shaver. 2008. Recommendations for Development of Resilience-Based State-and-Transition Models. *Rangeland Ecology & Management* 61:359–367.

Chambers, J.C., J.L. Beck, T.J. Christiansen, K.J. Clause, J.B. Dinkins, K.E. Doherty, K.A. Griffin, D.W. Havlina, K.F. Henke, L.L. Kurth, J.D. Maestas, M. Manning, K.E. Mayer, B.A. Meador, C. McCarthy, M.A. Perea, and D.A. Pyke. 2016. Using resilience and resistance concepts to manage threats to sagebrush ecosystems, Gunnison sage-grouse, and Greater sage-grouse in their eastern range: A strategic multi-scale approach.. Gen. Tech. Rep. RMRS-GTR-356.. U.S. Department of Agriculture, Forest Service, Rocky Mountain Research Station, Fort Collins, CO. 1–143.

Clause, K. and J. Randall. 2014. Wyoming Sagebrush Die-Off Report. Unpublished.

LLC, . 2009. Greater Sage-Grouse Focused Herbaceous Monitoring of Moxa Arch Sagebrush Vegetation Treatments.

Miller, J.F., R.H. Frederick, and R.J. Tracey. 1973. "Precipitation-Frequency Atlas of the United States" NOAA Atlas 2, Volume 5 (Idaho). National Weather Service, Silver Spring, Maryland.

Miller, J.F., R.H. Frederick, and R.J. Tracey. 1973. "Precipitation-Frequency Atlas of the United States" NOAA Atlas 2, Volume 2 (Wyoming). National Weather Service, Silver Spring, Maryland.

Ott, J., F.F. Kilkenney, and D.D. Summers. 2019. Long-term vegetation recovery and invasive annual suppression in native and introduced postfire seeding treatments.. *Rangeland Ecology & Management* 72:640–653.

Schoeneberger, P.J. and D.A. Wysocki. 2017. Geomorphic Description System, Version 5.0..

Stringham, T.K., W.C. Kreuger, and P.L. Shaver. 2003. State and Transition Modeling: an ecological process approach. *Journal of Range Management* 56:106–113.

Winward, A. 2007. Boulder, Squaretop Area Field Notes. Field Notes. Unpublished.

## **Other references**

Site concept, plant community data, and interpretations are based on ecological site descriptions (ESDs) from MLRA 34A-Foothills and Basins West (10-14W).

This ESD replaces R034AY204WY Clayey MLRA 34A-Foothills and Basins West (Cy 10-14W), but only within geographic extent of the Bear River Valley LRU.

Further data collection and ecological site refinement are ongoing until the ESD has reached "Approved" status.

## **Contributors**

Bryan Christensen  
Karen Clause

## **Approval**

Kirt Walstad, 5/01/2024

## **Acknowledgments**

## Rangeland health reference sheet

Interpreting Indicators of Rangeland Health is a qualitative assessment protocol used to determine ecosystem condition based on benchmark characteristics described in the Reference Sheet. A suite of 17 (or more) indicators are typically considered in an assessment. The ecological site(s) representative of an assessment location must be known prior to applying the protocol and must be verified based on soils and climate. Current plant community cannot be used to identify the ecological site.

Author(s)/participant(s)	
Contact for lead author	
Date	05/01/2024
Approved by	Kirt Walstad
Approval date	
Composition (Indicators 10 and 12) based on	Annual Production

## Indicators

1. **Number and extent of rills:**

---

2. **Presence of water flow patterns:**

---

3. **Number and height of erosional pedestals or terracettes:**

---

4. **Bare ground from Ecological Site Description or other studies (rock, litter, lichen, moss, plant canopy are not bare ground):**

---

5. **Number of gullies and erosion associated with gullies:**

---

6. **Extent of wind scoured, blowouts and/or depositional areas:**

---

7. **Amount of litter movement (describe size and distance expected to travel):**

---

8. **Soil surface (top few mm) resistance to erosion (stability values are averages - most sites will show a range of values):**

---

9. **Soil surface structure and SOM content (include type of structure and A-horizon color and thickness):**

---

10. **Effect of community phase composition (relative proportion of different functional groups) and spatial distribution on infiltration and runoff:**

---

11. **Presence and thickness of compaction layer (usually none; describe soil profile features which may be mistaken for compaction on this site):**

---

12. **Functional/Structural Groups (list in order of descending dominance by above-ground annual-production or live foliar cover using symbols: >>, >, = to indicate much greater than, greater than, and equal to):**

Dominant:

Sub-dominant:

Other:

Additional:

---

13. **Amount of plant mortality and decadence (include which functional groups are expected to show mortality or decadence):**

---

14. **Average percent litter cover (%) and depth ( in):**

---

15. **Expected annual annual-production (this is TOTAL above-ground annual-production, not just forage annual-production):**

---

16. **Potential invasive (including noxious) species (native and non-native). List species which BOTH characterize degraded states and have the potential to become a dominant or co-dominant species on the ecological site if their future establishment and growth is not actively controlled by management interventions. Species that become dominant for only one to several years (e.g., short-term response to drought or wildfire) are not invasive plants. Note that unlike other indicators, we are describing what is NOT expected in the reference state for the ecological site:**

---

17. **Perennial plant reproductive capability:**

---