

Ecological site BX013X01B022 Loamy Bear River Valley 10-14" P.Z.

Last updated: 5/01/2024
Accessed: 05/17/2024

General information

Provisional. A provisional ecological site description has undergone quality control and quality assurance review. It contains a working state and transition model and enough information to identify the ecological site.

MLRA notes

Major Land Resource Area (MLRA): 013X–Eastern Idaho Plateaus

Major Land Resource Area (MLRA) 13, Eastern Idaho Plateaus, consists of approximately 5 million acres in Idaho with a small part in Utah and Wyoming, it consists of 6 Land Resource Units (LRU). These units are divisions of the MLRA based on geology, landscape, common soils, water resources and plant community potentials. The elevation ranges from approximately 4500 to 6600 feet (1370 to 2010 m) on the plateaus and foothills to as much as 9500 feet (2895 m) on the mountains. Annual precipitation ranges from 10 to 48 inches (254-1220 mm), with the driest areas in the Bear River Valley on the far eastern portion and the wettest areas on the mountain summits. The Fort Hall Indian Reservation and several national forests are in this MLRA, including the Caribou, Cache, and Targhee National Forests. Yellowstone and Grand Teton National Parks occur just outside the northeast boundary.

LRU notes

The Bear River Valley LRU is located on the far eastern side of MLRA 13 between the Bear River Divide and the Monte Cristo Range, from Woodruff, Utah at the southern end to Cokeville, Wyoming at the northern end. The total area of the LRU is approximately 340,000 acres. It shares a boundary with MLRA 47 - Wasatch and Uinta Mountains, 43B - Central Rocky Mountains and 46 - Northern Rocky Mountain Foothills (proposed in Wyoming). This LRU differs from the others in its geology, which is comprised mostly of alluvium and colluvium from the Stump Formation. Its weather patterns are such that the soil moisture regime is xeric, meaning there is a slight peak in winter precipitation in this LRU, with typical yearly precipitation between 10 to 15 inches (254-380 mm). The soil temperature regime of this LRU is frigid with mean annual soil temperatures ranging from 44 to 48 degrees Fahrenheit (6.7-8.8 C). The elevation range is from 5700 to 7000 feet (1730-2130 m). The soils in the Bear River Valley are dominated by young aged very deep soils developed from sandstone and shale parent material re-worked with recent alluvium. Soils are dominated by Alfisols with young argillic horizons and by Fluvents in more recent alluvium.

The Bear River runs through this LRU, allowing for ample amounts of irrigation water used in the lowland areas to produce hay with smaller tributaries originating from the neighboring mountains.

Classification relationships

Relationship to Other Established Classification Systems

National Vegetation Classification System (NVC):

3 Semi-Desert

3.B.1 Cool Semi-Desert Scrub & Grassland

3.B.1.Ne Western North American Cool Semi-Desert Scrub & Grassland Division

M169 Great Basin & Intermountain Tall Sagebrush Shrubland & Steppe Macrogroup

G303 Intermountain Dry Tall Sage Steppe and Shrubland Group

A3182 Wyoming big sagebrush Mesic Steppe and Shrubland Alliance

CEGL001009 *Artemisia tridentata* ssp. *wyomingensis*/*Pseudoroegneria spicata* Shrubland Association

Ecoregions (EPA):

Level I: 10 North American Deserts

Level II: 10.1 Cold Deserts

Level III: 10.1.4 Wyoming Basin

Ecological site concept

Loamy Bear River Valley 10-14" P.Z. (Ly-BRV) is an upland ecological site with loamy soil surface textures (<32% clay) within the top 6 inches that is not limited by chemistry or water holding capacity (moderately deep to very deep with >5" AWC).

- This site not does receive any additional water.

- The soils are:

- o not saline or saline-sodic

- o moderately deep, deep, or very deep, greater than 20 inches (50 cm)

- o not skeletal within 20 inches (50 cm) of the soil surface (less than 35 percent rock fragments by volume in the top 20 inches)

- o not violently effervescent within top 20 inches (25 cm)

- o with surface textures including fine sandy loam, loam, silt loam, sandy clay loam, and lighter clay loam in surface mineral within top 6 inches (15 cm)

- have slopes less than 30 percent

- have clay content less than 32% in mineral soil surface within 6 inches (15 cm)

Climate:

xeric moisture regime

frigid temperature regime

Associated sites

BX013X01B026	Loamy Calcareous Bear River Valley 10-14" P.Z. This site has a high amount of calcium carbonate equivalent at a depth of 10-20 inches, with a different plant production and composition potential.
BX013X01B030	Overflow Bear River Valley 10-14" P.Z. This site is found in adjacent run-in landform positions. Has a higher plant production potential and different plant composition.
BX013X01B024	Loamy Argillic Bear River Valley 10-14" P.Z. This site has a heavy argillic subsurface layer within 20 inches (50cm) of the soil surface, lower production and different species composition potential.
BX013X01B004	Clayey Bear River Valley 10-14" P.Z. This site has a heavier clay content throughout, lower plant production, and different species composition potential.
BX013X01B050	Sandy Bear River Valley 10-14" P.Z. This site has lower clay content throughout. Clay content is below 18 percent. It has a different plant composition potential.
BX013X01B062	Shallow Loamy Bear River Valley 10-14" P.Z. This site is shallow and has a different plant composition potential.
BX013X01B063	Shallow Loamy Calcareous Bear River Valley 10-14" P.Z. This site is shallow to high calcium carbonate equivalent, is skeletal, and has different plant composition potential.

Similar sites

BX013X01B026	Loamy Calcareous Bear River Valley 10-14" P.Z. This site has a violent effervescent (>15% CCE) calcium carbonate layer within 20 inches (50cm) of the soils surface, limiting its production potential.
R034AY222WY	Loamy Foothills and Basins West (Ly) Previous version of this site used in Wyoming

Table 1. Dominant plant species

Tree	Not specified
Shrub	(1) <i>Artemisia tridentata</i> ssp. <i>wyomingensis</i> (2) <i>Artemisia tridentata</i> ssp. <i>tridentata</i>
Herbaceous	(1) <i>Pseudoroegneria spicata</i>

Legacy ID

R013XA122WY

Physiographic features

This site occurs on hillslope, alluvial fan, and fan remnant landforms at elevations between 5,700 and 7,000 feet. This site occurs on all aspects. The slopes range from level to 30 percent. Runoff is low and flooding and ponding do not occur on this site.

Landscape Definition:

hills -- A landscape dominated by hills and associated valleys.

valley -- An elongate, relatively large, externally drained depression of the Earth's surface that is primarily developed by stream erosion or glacial activity.

Landform Definition:

alluvial fan--A low, outspread mass of loose materials and rock material, commonly with gentle slopes. It is shaped like an open fan or a segment of a cone. The material was deposited by a stream at the place where it issues from a narrow mountain valley or upland valley, or where a tributary stream is near or at its junction with the main stream. The fan is steepest near its apex, which points upstream and slopes gently and convexly outward (downstream) with a gradual decrease in gradient.

hillslope -- A generic term for the steeper part of a hill between its summit and the drainage line, valley flat, or depression floor at the base of the hill.

fan remnant -- A general term for landforms that are the remaining parts of older, non-active fan- landforms, such as alluvial fans, fan aprons, inset fans, and fan skirts, that either have been dissected (erosional fan-remnants) or partially buried (non-buried fan-remnants). An erosional fan remnant must retain a relatively flat summit that is a relict fan-surface (greater than 50 percent intact). A non-buried fan-remnant is a relict surface in its entirety. Similar terms are eroded fan remnant, eroded fan remnant sideslope, ballena.

Table 2. Representative physiographic features

Landforms	(1) Hills > Alluvial fan (2) Valley > Fan remnant (3) Hillslope
Runoff class	Negligible to low
Flooding frequency	None
Ponding frequency	None
Elevation	1,737–2,134 m
Slope	0–30%
Water table depth	152–508 cm
Aspect	Aspect is not a significant factor

Climatic features

Annual precipitation in the Bear River Valley ranges from 10 to 14 inches per year. Wide fluctuations may occur in

yearly precipitation and result in more below average years than those with above average precipitation. Temperatures show a wide range between summer and winter and between daily maximums and minimums. This is predominantly due to the high elevation and dry air, which permits rapid incoming and outgoing radiation. Cold air outbreaks in winter move rapidly from northwest to southeast and account for extreme minimum temperatures. Roughly 25 to 30 percent of the precipitation occurs during the critical growth period, but the majority of precipitation accumulates outside the growing season, creating xeric-like conditions. The wettest rainfall month is May. The dominant plants (sagebrush and cool season grasses) are well adapted to these conditions. Daytime winds are generally stronger than nighttime and occasional strong storms may bring brief periods of high winds with gusts to more than 50 mph. The growing season is short (60 to 90 days) and cool (critical growth period): primary growth typically occurs between May and June. Growth of native cool-season plants begins about mid-April and continues to approximately early July. Some green-up of cool-season plants usually occurs in September with adequate fall moisture.

All data is based on the 30 year average from 1981 through 2010.

Table 3. Representative climatic features

Frost-free period (characteristic range)	40-90 days
Freeze-free period (characteristic range)	50-110 days
Precipitation total (characteristic range)	254-356 mm
Frost-free period (actual range)	35-90 days
Freeze-free period (actual range)	30-110 days
Precipitation total (actual range)	203-406 mm
Frost-free period (average)	60 days
Freeze-free period (average)	80 days
Precipitation total (average)	305 mm

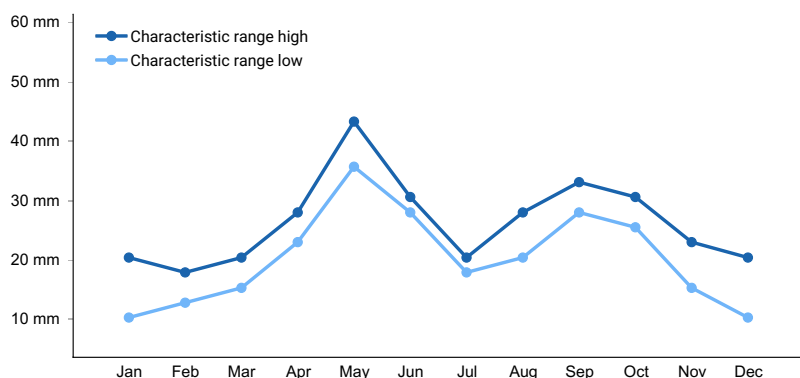

Figure 1. Monthly precipitation range

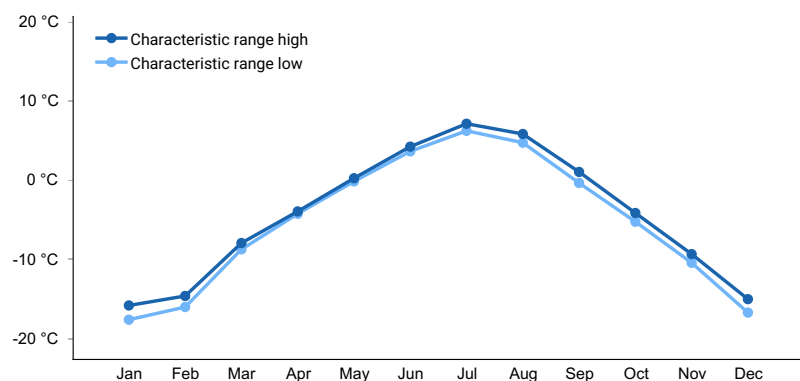

Figure 2. Monthly minimum temperature range

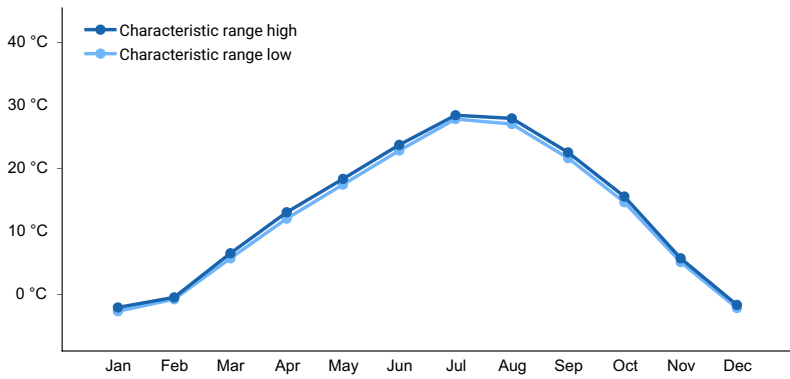

Figure 3. Monthly maximum temperature range

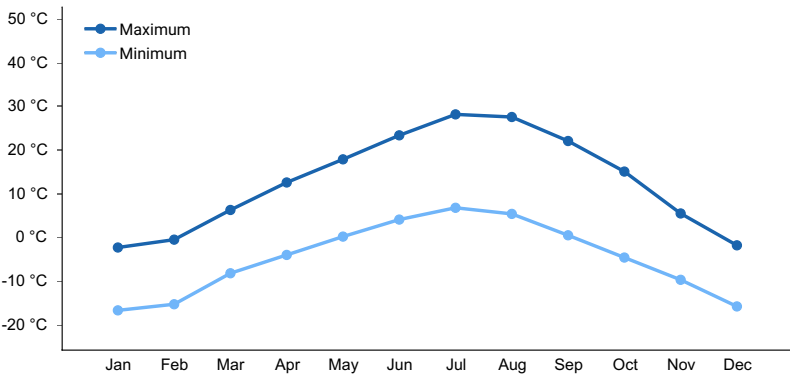

Figure 4. Monthly average minimum and maximum temperature

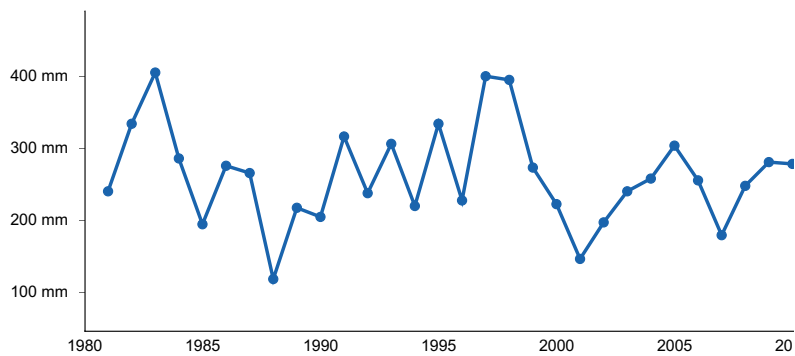

Figure 5. Annual precipitation pattern

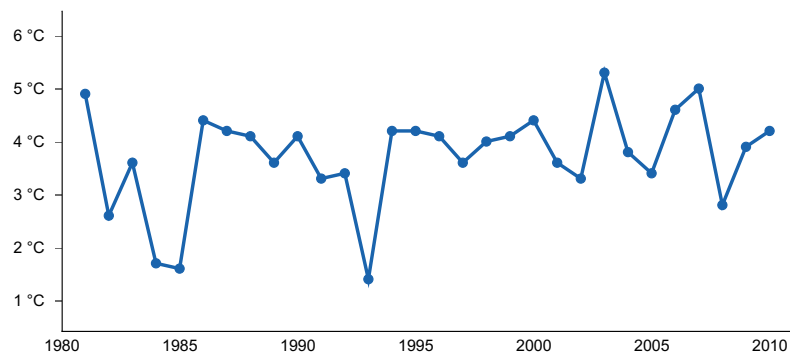

Figure 6. Annual average temperature pattern

Climate stations used

- (1) RANDOLPH [USC00427165], Randolph, UT
- (2) WOODRUFF [USC00429595], Woodruff, UT
- (3) SAGE 4 NNW [USC00487955], Cokeville, WY

Influencing water features

There are no influencing water features associated with this ecological site.

Wetland description

N/A

Soil features

The soils of this site are moderately deep to very deep (20 to 200 inches) and formed in alluvium derived from sandstone, limestone, shale, and conglomerate. Surface textures include fine sandy loam, loam, silt loam, sandy clay loam, and light clay loam with less than 32 percent clay content. Rock fragments may be found on the soil surface or in the profile and make up less than 15 percent of the soil volume. These soils are typically well-drained and have moderately slow to moderate permeability. The soil moisture regime is xeric and the soil temperature regime is frigid.

Major soil series correlated to this site include: Bancroft, Covey, Cloudless, Leefe, Randor, Remainder, Shearing, Woodpass, Pancheri and Thatcher.

Taxonomy: Loamy, mixed, superactive, frigid Calcic Haploxeralfs; Fine-Silty, mixed, superactive, frigid Calcic Haploxerolls; Fine-loamy, mixed, superactive, frigid Calcic Argixerolls; and Fine-loamy, mixed, superactive, frigid Calcic Haploxeralfs.

Table 4. Representative soil features

Parent material	(1) Slope alluvium–sandstone and shale (2) Alluvium–metamorphic and sedimentary rock
Surface texture	(1) Loam (2) Silt loam (3) Fine sandy loam (4) Sandy clay loam
Family particle size	(1) Fine-loamy
Drainage class	Well drained
Permeability class	Moderate to moderately slow
Depth to restrictive layer	53–508 cm
Soil depth	51–508 cm
Surface fragment cover <=3"	1–10%
Surface fragment cover >3"	0–5%
Available water capacity (0-101.6cm)	12.7–20.32 cm
Calcium carbonate equivalent (0-50.8cm)	0–15%
Clay content (0-15.2cm)	16–32%
Electrical conductivity (0-50.8cm)	0–2 mmhos/cm
Sodium adsorption ratio (0-50.8cm)	0–2
Soil reaction (1:1 water) (0-50.8cm)	7.2–8
Subsurface fragment volume <=3" (50.8-152.4cm)	5–15%

Subsurface fragment volume >3" (50.8-152.4cm)	0-25%
--	-------

Ecological dynamics

A State-and-Transition Model (STM) diagram is depicted in this section. Thorough descriptions of each state, transition, plant community phase, and pathway are found after the model in this document. This diagram is based on available experimental research, field observations, professional consensus, and interpretations. While based on the best available information, the STM will change over time as knowledge of ecological processes increases.

Plant community composition within the same ecological site has a natural range of variability across the LRU due to the naturally occurring variability in weather, soils, and aspect. Not all managers will choose the Reference Plant Community as the management goal. Other plant communities may be desired to meet land management objectives. This is valid as long as the rangeland health attributes assessment departures are none to slight or slight to moderate from the Reference State. The biological processes on this site are complex; therefore, representative values are presented in a land management context. The species lists are representative and are not botanical descriptions of all species occurring, or potentially occurring, on this site. They are not intended to cover every situation or the full range of conditions, species, and responses for the site.

Both percent species composition by weight and percent cover are used in this ESD. Most observers find it easier to visualize or estimate percent cover for woody species (trees and shrubs). Foliar cover is used to define plant community phases and states in the State-and-Transition Model. Cover drives the transitions between communities and states because of the influence of shade and interception of rainfall.

Species composition by dry weight remains an important descriptor of the herbaceous community and of site productivity as a whole and includes both herbaceous and woody species. Calculating similarity index requires data on species composition by dry weight.

Although there is considerable qualitative experience supporting the pathways and transitions within the State-and-Transition Model, no quantitative information exists that specifically identifies threshold parameters between reference states and degraded states in this ecological site. For information on STMs, see the following citations: Bestelmeyer et.al. 2003, Bestelmeyer et.al. 2004, Bestelmeyer et.al. 2010, Bestelmeyer and Brown 2005, Briske et.al. 2008, and Stringham et.al. 2003.

A resource concern risk assessment and dominant resource concerns are provided for each Land Use, State, and/or Plant Community Phase based on NRCS resource concern and planning criteria used to determine resource treatment levels during the conservation planning process. A resource concern is the resource condition that does not meet the minimum accepted levels established by planning criteria as shown in Section III of the NRCS Field Office Technical Guide (<https://efotg.sc.egov.usda.gov/#/>).

- Low risk means a low probability for the category of resource concerns and additional assessment is typically not necessary.
- Medium risk means that the category of resource concerns could occur, and additional assessment is recommended if the identified resource is a client concern and/or objective.
- High risk means that a resource concern in that category is likely to occur.

The resource categories are: S (soil), W (water), A (air), P (plant), A (animal), E (energy), and H (human). The dominant resource concerns further refine the resource category to a specific resource concern within that category.

State and transition model

Land uses

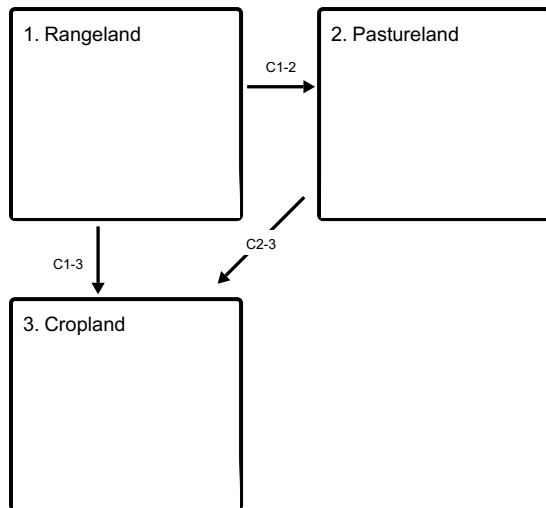

C1-2 - Flood irrigation, tillage, and seeding

C1-3 - Irrigation (improved flood or sprinkler), tillage, and seeding

C2-3 - Sprinkler irrigation, tillage, and seeding

Land use 1 submodel, ecosystem states

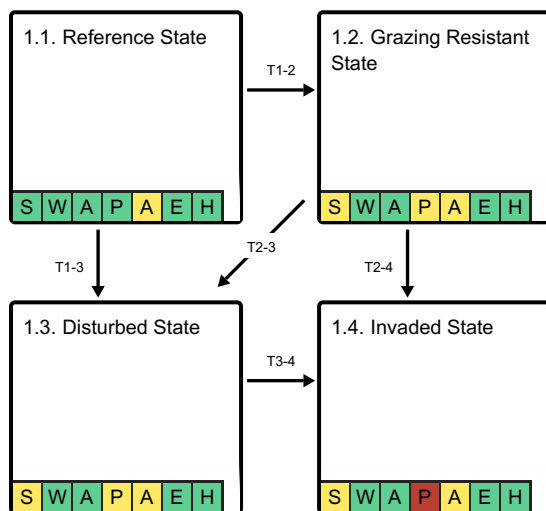

T1-2 - Herbivory (continuous or season-long, low to moderate stocking)

T1-3 - Soil disturbance (e.g. hoof action, rodents, water erosion) and high intensity fire or chemical/mechanical treatment

T2-3 - Soil disturbance (e.g. hoof action, rodents, water erosion) and high intensity fire or chemical/mechanical treatment

T2-4 - Extreme herbivory (continuous, high intensity)

T3-4 - Extreme disturbance (e.g. catastrophic fire, drought, soil removal)

State 1 submodel, plant communities

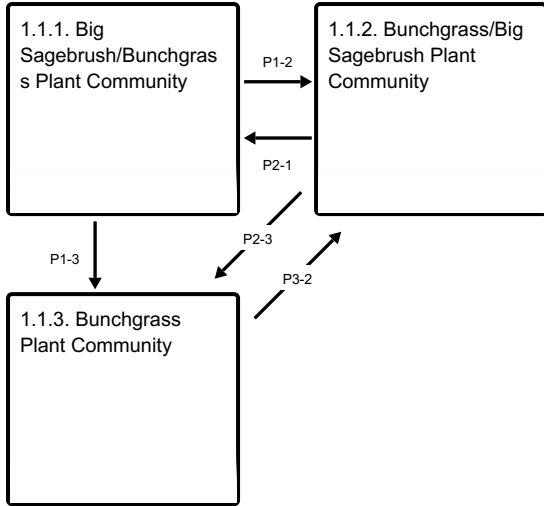

P1-2 - Sage-thinning event (drought, prolonged soil saturation, freeze-kill, snow mold, low intensity fire, herbivory, chemical/mechanical treatment)

P1-3 - Sage-killing event (severe drought, prolonged soil saturation, freeze-kill, snow mold, moderate intensity fire, herbivory, or mechanical/chemical treatment)

P2-1 - Natural Succession

P2-3 - Sage-killing event (severe drought, prolonged soil saturation, freeze-kill, snow mold, moderate intensity fire, herbivory, mechanical/chemical treatment)

P3-2 - Natural Succession

State 2 submodel, plant communities

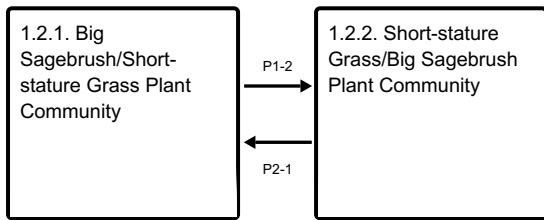

P1-2 - Sage-killing event (mechanical or chemical treatment, herbivory, drought, prolonged soil saturation, freeze-kill, snow mold)

P2-1 - Natural Succession

State 3 submodel, plant communities

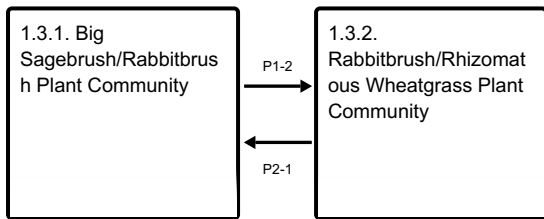

P1-2 - Sage-killing event (high intensity fire, consecutive mechanical or chemical treatments)

P2-1 - Natural Succession

State 4 submodel, plant communities

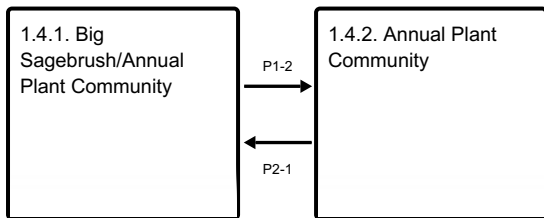

P1-2 - Sage-killing Event (catastrophic fire, mechanical treatment)

P2-1 - Natural Succession

Land use 2 submodel, ecosystem states

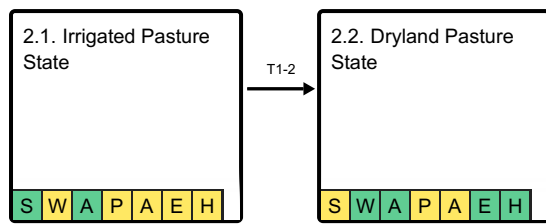

T1-2 - Irrigation abandonment

Land use 3 submodel, ecosystem states

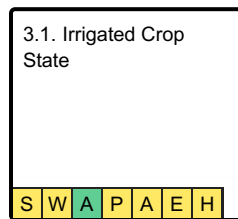

Land use 1 Rangeland

Rangeland is the dominant land use for the Loamy BRV ecological site and provides the most diverse ecosystem services. Rangeland is land on which the historic and introduced vegetation is predominantly grasses, grass-like plants, forbs or shrubs managed as a natural ecosystem. Range may include natural grasslands, savannas, shrublands, tundra, alpine communities, marshes and meadows.

Characteristics and indicators. This land use consists of diverse native plant communities dominated by big sagebrush and perennial cool season grasses that provide for site stability, hydrologic function, and biotic integrity of the site.

State 1.1 Reference State

The Reference State consists of three plant communities: the Big Sagebrush/Bunchgrass community (1.1.1), the Bunchgrass/Big Sagebrush community (1.1.2), and the Bunchgrass community (1.1.3). Each plant community differs in percent composition and foliar cover of bunchgrasses and shrubs. Dominant shrubs are Wyoming big sagebrush in moderately deep to deep sites and basin big sagebrush in very deep sites and silt loams. Forbs are a minor component. Two important processes occur in the Reference State and result in plant community changes: 1) sagebrush-killing disturbances such as fire, herbivory, drought, and flood; and 2) time without those disturbances, generally referred to as "natural succession."

Characteristics and indicators. The shift between plant community phases is dependent upon sagebrush-killing disturbances, and without them sagebrush will increase even with proper grazing management. Improper grazing management may accelerate the rate of increase for the shrub component. Management actions can and are often used to mimic the natural disturbance regime through mechanical and chemical treatments. Prescribed fire is not often used due to land use and ownership patterns, lack of fine fuels, and adequate burn windows (Clause and Randall, 2014).

Resilience management. This site has moderate resilience due to its xeric soil moisture regime and frigid temperature regime (Chambers et.al. 2014). Precipitation is typically adequate and more effective with cooler temperatures, but timing of precipitation lowers resilience. Moisture is often not present when needed to support recovery efforts. The site can usually recover after disturbance but is susceptible to delays in recovery during extreme climatic events such as drought. The site has moderately low resistance to invasion by annual grasses because of climate suitability. Winter precipitation patterns favor annual invasion while cooler temperatures provide

some resistance. The site is susceptible to invasion during hotter climatic periods.

Dominant plant species

- Wyoming big sagebrush (*Artemisia tridentata ssp. wyomingensis*), shrub
- basin big sagebrush (*Artemisia tridentata ssp. tridentata*), shrub
- bluebunch wheatgrass (*Pseudoroegneria spicata*), grass

Dominant resource concerns

- Terrestrial habitat for wildlife and invertebrates
- Inadequate livestock water quantity, quality, and distribution

Community 1.1.1

Big Sagebrush/Bunchgrass Plant Community

The Big Sagebrush/Bunchgrass Plant Community is well adapted to Eastern Idaho Plateaus climatic conditions. The diversity in plant species allows for drought tolerance, and natural plant mortality is very low. These plants have strong, healthy root systems that allow production to increase significantly with favorable moisture conditions. Abundant plant litter is available for soil building and moisture retention. Plant litter is properly distributed with very little movement off-site. This plant community provides for soil stability and a properly functioning hydrologic cycle. The soils associated with this site are fertile and hold moderately large amounts of soil moisture, providing a very favorable soil-water-plant relationship. The Big Sagebrush/Bunchgrass Community (1.1.1) can occur across the entire ecological site or can occur in a mosaic. This community can occur over time without these disturbances and accelerated with added herbaceous grazing pressure. Wyoming and basin big sagebrush are dominant. Sagebrush canopy cover ranges from 15 to 25 percent. At this sagebrush canopy level in this precipitation zone, there is some competition between the shrub over-story and the herbaceous under-story. (Winward 2007) A Big Sagebrush/Bunchgrass Community with a degraded under-story is an “at-risk” community, particularly when occurring homogeneously across the landscape. In the Big Sagebrush/Bunchgrass Community (1.1.1), there are generally few canopy gaps, and most basal gaps are small (one to two feet). Rock cover on the soil surface is essentially nonexistent. Many plant inter-spaces have canopy or litter cover. Production of grasses is much lower than in the Bunchgrass Community (1.1.3) and slightly lower than in the Bunchgrass/Big Sagebrush Community (1.1.2).

Table 5. Annual production by plant type

Plant Type	Low (Kg/Hectare)	Representative Value (Kg/Hectare)	High (Kg/Hectare)
Shrub/Vine	448	560	673
Grass/Grasslike	359	448	538
Forb	90	112	135
Total	897	1120	1346

Table 6. Ground cover

Tree foliar cover	0%
Shrub/vine/liana foliar cover	15-25%
Grass/grasslike foliar cover	25-35%
Forb foliar cover	1-5%
Non-vascular plants	0%
Biological crusts	0-1%
Litter	15-40%
Surface fragments >0.25" and <=3"	0-5%
Surface fragments >3"	0-1%
Bedrock	0%

Water	0%
Bare ground	10-20%

Table 7. Soil surface cover

Tree basal cover	0%
Shrub/vine/liana basal cover	1-5%
Grass/grasslike basal cover	1-5%
Forb basal cover	0-1%
Non-vascular plants	0%
Biological crusts	0-1%
Litter	40-70%
Surface fragments >0.25" and <=3"	1-10%
Surface fragments >3"	0-5%
Bedrock	0%
Water	0%
Bare ground	10-20%

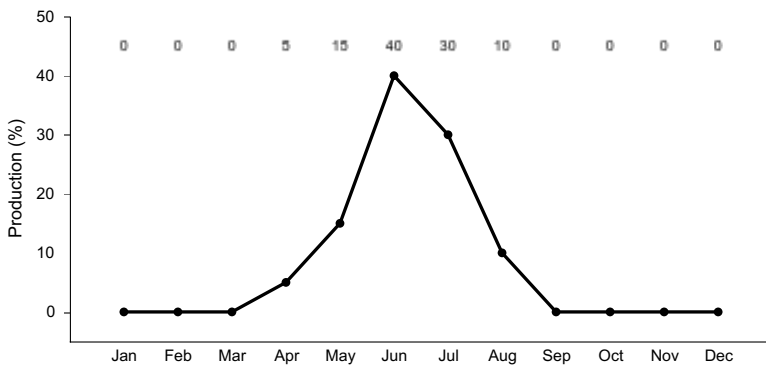

Figure 8. Plant community growth curve (percent production by month). WY0304, 10-14W - Upland Sites.

Community 1.1.2 Bunchgrass/Big Sagebrush Plant Community



The Bunchgrass/Big Sagebrush Community (1.2) can occur across the entire ecological site on a given landscape but more likely occurs in a mosaic pattern associated with the disturbance cycle at any given location. Mid-stature bunchgrasses dominate in the Bunchgrass/Big Sagebrush Community (1.1.2) with sagebrush sub-dominant with cover ranging from 5 to 15 percent. At this sagebrush canopy level in this precipitation zone, there is little if any

competition between the shrub over-story and the herbaceous under-story. In fact, there is evidence to suggest that the under-story receives more benefit from the sage over-story than negative effects. (Winward 2007). This community can occur after a sagebrush thinning event, such as drought, insects, or disease, or it can take longer to occur after a stand replacing event. Brush Management is a conservation practice used to achieve this plant community. Chemical treatment of shrubs has replaced natural sagebrush killing events on many sites in the area. However, chemical treatments impact non-target species, particularly broad-leafed species (forbs and shrubs) differently than natural events such as drought or fire. Where fire tends to result in a short-term increase in forbs, some chemical treatments result in a short-term (or medium-term) reduction in forb density and diversity. Chemical treatment of sagebrush with tebuthiuron can have impacts to the under-story, depending on application rate. (WWC 2009). There is a danger of transition to the Disturbed State if multiple consecutive treatments occur. In the Bunchgrass/Big Sagebrush Community (1.1.2), there are generally few canopy gaps, and most basal gaps are generally small (one to two feet). Rock cover on the soil surface is essentially nonexistent. Most shrub inter-spaces have canopy or litter cover. Production of grasses is slightly lower than in the Bunchgrass Community (1.1.3), but higher than in the Big sagebrush/Bunchgrass (1.1.1).

Table 8. Annual production by plant type

Plant Type	Low (Kg/Hectare)	Representative Value (Kg/Hectare)	High (Kg/Hectare)
Grass/Grasslike	493	616	740
Shrub/Vine	314	392	471
Forb	90	112	135
Total	897	1120	1346

Table 9. Ground cover

Tree foliar cover	0%
Shrub/vine/liana foliar cover	5-15%
Grass/grasslike foliar cover	35-45%
Forb foliar cover	1-5%
Non-vascular plants	0%
Biological crusts	0-1%
Litter	15-40%
Surface fragments >0.25" and <=3"	0-5%
Surface fragments >3"	0-1%
Bedrock	0%
Water	0%
Bare ground	10-20%

Table 10. Soil surface cover

Tree basal cover	0%
Shrub/vine/liana basal cover	1-5%
Grass/grasslike basal cover	1-5%
Forb basal cover	0-1%
Non-vascular plants	0%
Biological crusts	0-1%
Litter	40-70%
Surface fragments >0.25" and <=3"	1-10%
Surface fragments >3"	0-5%

Bedrock	0%
Water	0%
Bare ground	10-20%

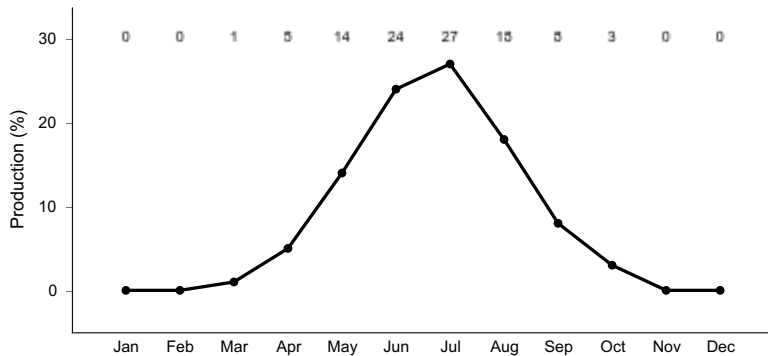

Figure 10. Plant community growth curve (percent production by month). WY13X01Bu, MLRA 13-Bear River Valley-upland. Forage Production (herbaceous only) Developed by using the Rangeland Analysis Platform (RAP).

Community 1.1.3 Bunchgrass Plant Community

The Bunchgrass Community (1.1.3) is dominated by mid-stature cool-season bunchgrasses mixed with a minor component of forbs and shrubs. Big sagebrush is present as a part of the community, but is minor with up to 5 percent foliar cover. This community can occur after a sagebrush stand-replacing event, such as fire, herbivory, severe drought, or flooding. Brush Management is a conservation practice used to achieve this plant community. Chemical treatment of shrubs has replaced natural sagebrush killing events on many sites in the area. However, chemical treatments impact non-target species, particularly broad-leafed species (forbs and shrubs) differently than natural events such as drought or fire. Where fire tends to result in a short-term increase in forbs, some chemical treatments result in a short-term (or medium-term) reduction in forb density and diversity. Chemical treatment of sagebrush with tebuthiuron can have impacts to the under-story, depending on application rate. (WWC 2009). There is a danger of transition to the Disturbed State if multiple consecutive treatments occur. There are more canopy gaps in this plant community, but most basal gaps are generally small (1-2 feet). Rock cover on the soil surface is essentially non-existent. Production of grasses is higher than the other plant communities in the Reference State.

Table 11. Annual production by plant type

Plant Type	Low (Kg/Hectare)	Representative Value (Kg/Hectare)	High (Kg/Hectare)
Grass/Grasslike	673	841	1009
Shrub/Vine	135	168	202
Forb	90	112	135
Total	898	1121	1346

Table 12. Ground cover

Tree foliar cover	0%
Shrub/vine/liana foliar cover	1-5%
Grass/grasslike foliar cover	40-50%
Forb foliar cover	1-10%
Non-vascular plants	0%
Biological crusts	0%
Litter	15-40%

Surface fragments >0.25" and <=3"	0-5%
Surface fragments >3"	0-1%
Bedrock	0%
Water	0%
Bare ground	10-20%

Table 13. Soil surface cover

Tree basal cover	0%
Shrub/vine/liana basal cover	0-1%
Grass/grasslike basal cover	1-5%
Forb basal cover	1-5%
Non-vascular plants	0%
Biological crusts	0%
Litter	40-70%
Surface fragments >0.25" and <=3"	1-10%
Surface fragments >3"	0-5%
Bedrock	0%
Water	0%
Bare ground	10-20%

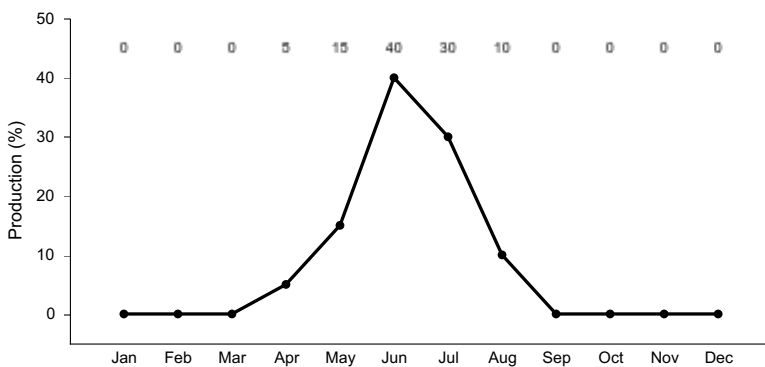

Figure 12. Plant community growth curve (percent production by month). WY0304, 10-14W - Upland Sites.

Pathway P1-2 Community 1.1.1 to 1.1.2

Sagebrush thinning event via low intensity fire or climatic events such as drought, prolonged soil saturation, freeze-kill, snow mold, and herbivory. Anthropogenic sagebrush thinning events such as chemical (tebuthiuron) or mosaic mechanical (mowing, aerator, etc.) can result in a similar pathway in the absence of annual invasives.

Context dependence. Thinning events are often episodic with climatic events and can occur suddenly with a particular event (precipitation, temperature, insect irruption, etc.) or can be gradual over a period of years such as during prolonged drought/warm or wet/cool periods. A successful pathway is contingent upon a grazing regime that allows for periodic critical growth period rest (May through June). An integrated pest management plan is needed to prevent, avoid, manage, and suppress invasive species.

Conservation practices

Brush Management
Prescribed Grazing

Pathway P1-3

Community 1.1.1 to 1.1.3

Sagebrush killing event such as moderate intensity fire or climatic events such as severe drought, prolonged soil saturation, freeze-kill, snow mold, and herbivory. Anthropogenic sagebrush thinning events such as chemical (tebuthiuron) or mosaic mechanical (mowing, aerator, etc.) can result in a similar pathway in the absence of annual invasives.

Context dependence. Killing events are often episodic with climatic events and can occur suddenly with a particular event (fire, precipitation, temperature, insect irruption, etc.). A successful pathway is contingent upon a grazing regime that allows for periodic critical growth period rest (May-June). An integrated pest management plan is needed to prevent, avoid, manage, and suppress invasive species.

Conservation practices

Brush Management
Prescribed Grazing

Pathway P2-1

Community 1.1.2 to 1.1.1

Natural succession (time without sagebrush killing event).

Context dependence. Time period for pathway is dependent upon weather events such as drought and above normal precipitation years. Drought results in slower pathway while favorable precipitation can result in a faster pathway. A grazing regime that mimics the historic regime (light intensity, episodic grazing events) will not alter the pathway, but a continuous grazing regime at moderate to heavy intensity can accelerate the pathway.

Pathway P2-3

Community 1.1.2 to 1.1.3

Sagebrush killing event such as moderate intensity fire or climatic events such as severe drought, prolonged soil saturation, freeze-kill, snow mold, and herbivory. Anthropogenic sagebrush thinning events such as chemical (tebuthiuron) or mosaic mechanical (mowing, aerator, etc.) can result in a similar pathway in the absence of annual invasives.

Context dependence. Killing events are often episodic with climatic events and can occur suddenly with a particular event (fire, precipitation, temperature, insect irruption, etc.). A successful pathway is contingent upon a grazing regime that allows for periodic critical growth period rest (May-June). An integrated pest management plan is needed to prevent, avoid, manage, and suppress invasive species.

Conservation practices

Brush Management
Prescribed Grazing

Pathway P3-2

Community 1.1.3 to 1.1.2

Natural succession (time without sagebrush killing event).

Context dependence. Time period for pathway is dependent upon weather events such as drought and above normal precipitation years. Drought results in slower pathway while favorable precipitation can result in a faster pathway. A grazing regime that mimics the historic regime (light intensity, episodic grazing events) will not alter the pathway, but a continuous grazing regime at moderate to heavy intensity can accelerate the pathway.

State 1.2

Grazing Resistant State

The Grazing Resistant State has seen a shift in under-story functional/structural group dominance. Due to herbivory pressure, there is a shift from mid-stature cool-season bunchgrasses to short-stature cool-season bunchgrasses such as Sandberg bluegrass and rhizomatous wheatgrasses like thickspike wheatgrass and western wheatgrass.

Characteristics and indicators. There are fewer mid-size bunchgrasses and they are typically found under the shrub canopy where they are protected from herbivory. The shrub canopy inter-spaces are occupied by grazing tolerant grasses as well as patches of bare ground that are sometimes connected. Canopy gaps and bare ground increase, while herbaceous foliar cover decreases. Drier site conditions result in lower productivity and less herbaceous production potential. Decreased infiltration is caused by increased bare ground patch size and lack of litter that acts as mulch in retaining soil moisture and retarding runoff. In many cases, the transition to the Grazing Resistant State may have occurred many decades ago during an era of higher stocking rates and continuous grazing during the growing season. However, continual grazing during the critical growth period (roughly May-June) at proper stocking rates will facilitate the transition to this state and maintain it as a stable state.

Resilience management. Site resilience is lower than the Reference State. Site hydrology has been modified due to moisture being utilized by shallower rooting species. Therefore, the site is drier earlier in the season and unable to recover as quickly after a disturbance. This state is more drought-prone, and therefore more vulnerable to invasion by annual invasive species. However, existing sagebrush canopy and remnant perennial vegetation provide some amount of resiliency. Rhizomatous grasses form mats that provide soil protection by protecting the soil from raindrop impact, decreasing the risk of soil erosion. However, overall soil stability is lower than the Reference State, primarily due to a reduction in soil organic matter due to a decrease in litter. Site resistance to invasion by annual grasses is lower due to niches in the under-story for establishment as well as site water availability during the time suited for winter annuals such as cheatgrass (*Bromus tectorum*). Episodic and limited moisture is more suited to annual life forms.

Dominant plant species

- Wyoming big sagebrush (*Artemisia tridentata ssp. wyomingensis*), shrub
- basin big sagebrush (*Artemisia tridentata ssp. tridentata*), shrub
- Sandberg bluegrass (*Poa secunda*), grass
- western wheatgrass (*Pascopyrum smithii*), grass

Dominant resource concerns

- Sheet and rill erosion
- Classic gully erosion
- Plant productivity and health
- Plant structure and composition
- Terrestrial habitat for wildlife and invertebrates
- Feed and forage imbalance
- Inadequate livestock water quantity, quality, and distribution

Community 1.2.1

Big Sagebrush/Short-stature Grass Plant Community



This plant community is characterized by a dense stand of big sagebrush with a diminished under-story. It has a mix of Wyoming big sagebrush and basin big sagebrush, with Wyoming big sagebrush being dominant on moderately deep to deep sites while basin big sage dominates on very deep sites. The under-story has lost much of the mid-stature cool-season bunchgrasses, and they have been replaced with short-stature bunchgrasses such as Sandberg bluegrass, rhizomatous wheatgrasses, and mat-forming forbs. Shrub foliar cover is often greater than 25 percent, higher than in the reference state and typically making up over half of total annual production. Areas that catch and retain snow are more likely to have higher shrub cover. Herbaceous production and foliar cover has decreased. There are often small amounts of annual invasive grasses, mostly less than 5 percent foliar cover. There is often a slight increase in sprouting shrubs (less than 10 percent composition by weight). This plant community is at-risk of transitioning to the Invaded State with additional disturbance such as heavy grazing, sagebrush treatment, or ground-disturbing activity. Productivity is highly variable and fluctuates drastically in response to drought and wet cycles. Total annual production is lower than in Reference State (1.1), leading to lower soil organic matter content and therefore lower soil stability than in the Reference State. Total annual production ranges from 600 to 1,000 pounds per acre (lbs/ac) with a RV of 800 lbs/ac. Ground cover is still high, but infiltration is lower than in the Reference State and the hydrologic function is impaired due to decreased soil organic matter. Biotic integrity is affected by the change in functional/structural group dominance.

Community 1.2.2

Short-stature Grass/Big Sagebrush Plant Community

This plant community is characterized by a dominance of short-stature grasses such as Sandberg bluegrass, rhizomatous grasses and grass-like, and mat-forming forbs. A sagebrush killing event has happened recently, and big sagebrush foliar cover is typically less than 15 percent. It has a mix of Wyoming big sagebrush and basin big sagebrush, with Wyoming big sagebrush being dominant on moderately deep to deep sites while basin big sage dominates on very deep sites. There can be an initial flush of invasive annuals, mainly cheatgrass, within the first few years of a sagebrush treatment, but they are expected to reduce to less than 5 percent foliar cover. There is often a slight increase in sprouting shrubs (less than 10 percent composition by weight). Total annual production ranges from 600 to 1,000 lbs/ac with a RV of 800 lbs/ac. This plant community is at-risk of transitioning to the Invaded State with additional disturbance such as heavy grazing, sagebrush treatment, or ground-disturbing activity.

Pathway P1-2

Community 1.2.1 to 1.2.2

Sagebrush killing event, typically anthropogenic sagebrush treatments such as chemical (tebuthiuron) or mechanical (mowing, aerator, etc.) and/or herbivory. Natural climatic events such as drought, prolonged soil saturation, freeze-kill, or snow mold, can also occur. Fire is not typically a driver in this state due to the lack of fine fuels in the under-story.

Context dependence. Killing events are often episodic with climatic events and can occur suddenly with a particular event (fire, precipitation, temperature, insect irruption, etc.). This pathway relies upon close to normal precipitation and temperature as well as a grazing regime that is low to moderate intensity. If extreme conditions/disturbances such as hot temperatures, drought, or high intensity grazing occur, there is risk of a transition to either the Disturbed State or Invaded State depending upon severity and cumulative disturbance.

Conservation practices

Brush Management

Pathway P2-1

Community 1.2.2 to 1.2.1

Natural succession (time without sagebrush killing event).

Context dependence. Time period for pathway is dependent upon weather events such as drought and above normal precipitation years. Drought results in slower pathway while favorable precipitation can result in a faster pathway. A grazing regime that mimics the historic regime (light intensity, episodic grazing events) will not alter the pathway, but a continuous grazing regime at moderate to heavy intensity can accelerate the pathway.

State 1.3

Disturbed State

The Disturbed State is a result of soil-disturbing activities outside of the normal disturbance regime expected for this site. Examples are high intensity hoof action, anthropogenic activity, rodent activity, or frequent flooding, which includes occasional irrigation. It may also occur after brush management preceded or followed by improper grazing techniques that include high-intensity grazing use without appropriate recovery periods. Brush management treatment methods include mechanical (including heavy equipment/construction or a mowing/chaining/harrow type sage treatment), chemical (including 2,4-D or tebuthiron), or biological (including browse and insects). Fire could be a factor in maintaining this plant community by stimulating sprouting shrubs (rabbitbrush) and killing sagebrush. Removal of shrubs without proper grazing management can lead to an increase in bare ground and erosion of the upper soil horizon. Consequences of this are decreased soil organic matter and soil erosion, soil crusting, and a decrease in soil surface aggregate stability.

Characteristics and indicators. There is a shift toward sprouting shrub dominance or co-dominance with big sagebrush depending on how long it has been since the disturbance(s). Both green and rubber rabbitbrush may be present. Along with a shift in shrub species, the herbaceous under-story also shifts toward more disturbance tolerant species such as western wheatgrass. Annual weeds such as bur buttercup, flixweed, and lambsquarter, and invasive annual grasses such as cheatgrass are often present in small amounts (less than 5 percent composition by dry weight).

Resilience management. Site resilience is lower than the Reference State or Grazing Resistant State, but higher than the Invaded State. Site hydrology has been modified due to moisture being utilized by shallower rooting species. Therefore, the site is drier earlier in the season and unable to recover as quickly after a disturbance. However, existing sagebrush canopy and remnant perennial vegetation provide some amount of resiliency. Site resistance to invasion by annual grasses is lower due to niches in the under-story for establishment as well as site water availability during the time suited for winter annuals such as cheatgrass (*Bromus tectorum*). Episodic and limited moisture is more suited to annual life forms during drought.

Dominant plant species

- yellow rabbitbrush (*Chrysothamnus viscidiflorus*), shrub
- rubber rabbitbrush (*Ericameria nauseosa*), shrub
- Wyoming big sagebrush (*Artemisia tridentata ssp. wyomingensis*), shrub
- basin big sagebrush (*Artemisia tridentata ssp. tridentata*), shrub
- western wheatgrass (*Pascopyrum smithii*), grass
- Sandberg bluegrass (*Poa secunda*), grass

Dominant resource concerns

- Sheet and rill erosion
- Classic gully erosion
- Plant productivity and health
- Plant structure and composition

- Plant pest pressure
- Terrestrial habitat for wildlife and invertebrates
- Feed and forage imbalance
- Inadequate livestock water quantity, quality, and distribution

Community 1.3.1

Big Sagebrush/Rabbitbrush Plant Community

This plant community is a result of recovery after a past soil-disturbing activity. It is co-dominated by sprouting shrubs, mainly green rabbitbrush (aka yellow rabbitbrush in USDA PLANTS) and Wyoming big sagebrush. The understory typically consists of a combination of perennial rhizomatous grasses, mainly western wheatgrass, and annual grasses and forbs. Total annual production ranges from 400 to 900 lbs/ac with a RV of 700 lbs/ac. The soil is typically adequately protected, but erosion can occur during high runoff events. The biotic integrity is reduced due to low vegetative production, relative dominance and unexpected structural/functional groups, and potentially invasive species if present. The watershed is functioning-at-risk.

Community 1.3.2

Rabbitbrush/Rhizomatous Wheatgrass Plant Community



This plant community is the result of a recent soil-disturbing activity. Western wheatgrass is the dominant perennial grass, and annual grasses and forbs are often present. With sagebrush removed, green or rubber rabbitbrush is the dominant shrub, often exceeding 30 percent of the annual production. Subdominant under-story species include bottlebrush squirreltail, Sandberg bluegrass, and unpalatable annual and perennial forbs. In the absence of annuals, there can be a substantial amount of bare ground. Total annual production ranges from 400 to 900 lbs/ac with a RV of 700 lbs/ac. The soil is not adequately protected, and erosion is expected without management to allow for adequate litter and residual. The biotic integrity is reduced due to low vegetative production, relative dominance and unexpected structural/functional groups, and potentially invasive species if present. The watershed is functioning-at-risk.

Pathway P1-2

Community 1.3.1 to 1.3.2

Sagebrush killing event, typically high intensity fire or consecutive anthropogenic sagebrush treatments such as chemical (tebuthiuron) or mechanical (mowing, aerator, etc.).

Context dependence. Killing events are often episodic with climatic events and can occur suddenly with a particular event (fire, precipitation, temperature, insect irruption, etc.). If extreme conditions/disturbances such as hot temperatures, drought, or high intensity grazing occur, there is risk of a transition to the Invaded State depending upon severity and cumulative disturbance.

Conservation practices

Brush Management

Pathway P2-1

Community 1.3.2 to 1.3.1

Natural succession (time without sagebrush killing event).

Context dependence. Time period for pathway is dependent upon weather events such as drought and above normal precipitation years. Drought results in slower pathway while favorable precipitation can result in a faster pathway. A grazing regime that mimics the historic regime (light intensity, episodic grazing events) will not alter the pathway, but a continuous grazing regime at moderate to heavy intensity can accelerate the pathway.

State 1.4

Invaded State

The Invaded State has seen a shift in dominance toward annual invasive grasses. It often occurs after a disturbance that occurs in conjunction with drought conditions.

Characteristics and indicators. In this state, sagebrush canopy varies, but the under-story is dominated by annual invasive and weedy species. There will be indicators of reduced soil and site stability as well as reduced hydrologic function, mainly water flow patterns and pedestals, but potentially rills and gullies. Soil surface loss and degradation is likely. Biotic integrity is affected by functional/structural groups not expected for the site, invasive plants, and the loss of perennial species and functional/structural groups. The site is more prone to drought with large fluctuations in annual production in response to weather events. The site is less diverse with lower quality habitat for wildlife and pollinators, and the risk of wildfire is increased from fine fuel production.

Resilience management. Site resilience is lower than all other states because the site hydrology has been modified resulting in greater runoff during spring melt and rainfall events. Therefore, the site is drier and unable to recover as quickly after a disturbance. Site resistance to invasion by annual grasses is lost due to niches in the under-story for establishment as well as site water availability during the time suited for winter annuals such as cheatgrass (*Bromus tectorum*). Episodic and limited moisture is more suited to annual life forms.

Dominant plant species

- yellow rabbitbrush (*Chrysothamnus viscidiflorus*), shrub
- rubber rabbitbrush (*Ericameria nauseosa*), shrub
- Wyoming big sagebrush (*Artemisia tridentata* ssp. *wyomingensis*), shrub
- basin big sagebrush (*Artemisia tridentata* ssp. *tridentata*), shrub
- cheatgrass (*Bromus tectorum*), grass
- herb sophia (*Descurainia sophia*), other herbaceous

Dominant resource concerns

- Sheet and rill erosion
- Classic gully erosion
- Plant productivity and health
- Plant structure and composition
- Plant pest pressure
- Wildfire hazard from biomass accumulation
- Terrestrial habitat for wildlife and invertebrates
- Feed and forage imbalance
- Inadequate livestock water quantity, quality, and distribution

Community 1.4.1

Big Sagebrush/Annual Plant Community

This plant community is often the result of improper grazing and historic disturbances. Improper grazing is defined as either high- or low-intensity grazing without the appropriate recovery period. Wyoming big sagebrush and/or rabbitbrush dominates with annual production often exceeding 40 percent. The under-story is dominated by annual grasses and forbs while perennial grass and forbs are sparse and bunchgrasses are limited to the protected areas

under shrubs. The predominant perennial grasses include Sandberg bluegrass and rhizomatous wheatgrass (western wheatgrass). Total annual production ranges from 400 to 800 lbs/ac with a RV of 600 lbs/ac. Soil erosion is accelerated because of the lack of deep-rooted perennials. The biotic community has been compromised. The watershed is degraded. Water flow patterns and pedestals are obvious. Infiltration is reduced, and runoff is increased.

Community 1.4.2 Annual Plant Community

This plant community results from a severe sagebrush killing disturbance once a site has been invaded by annuals. Repeated disturbances, such as fire, can maintain this plant community, but that is a rare occurrence for this site. Otherwise, sagebrush will typically re-establish on this site fairly quickly, within 5 to 10 years. However, to achieve pre-disturbance sagebrush canopy levels will take much longer. This site has low potential for recovery once dominated by annuals. Seeding is recommended to restore herbaceous perennial functional structural groups. Productivity in this plant community phase is highly variable based on current year's weather, and can range from 400 lbs./ac. or less up to 800 lbs./ac., with representative value of 600 lbs./ac.

Pathway P1-2 Community 1.4.1 to 1.4.2

Sagebrush killing event, typically catastrophic fire or mechanical sagebrush treatments (mowing, aerator, disking, etc.)

Context dependence. Killing events are often episodic with climatic events and can occur suddenly with a particular event (fire, precipitation, temperature, insect irruption, etc.). Consecutive disturbances and extreme conditions such as hot temperatures, drought, or high intensity grazing will exacerbate this pathway to an annual dominated system.

Conservation practices

Brush Management

Pathway P2-1 Community 1.4.2 to 1.4.1

Natural succession (time without sagebrush killing event).

Context dependence. Time period for pathway is dependent upon weather events such as drought and above normal precipitation years. Drought results in slower pathway while favorable precipitation can result in a faster pathway. A grazing regime that mimics the historic regime (light intensity, episodic grazing events) will not alter the pathway, but a continuous grazing regime at moderate to heavy intensity can accelerate the pathway.

Transition T1-2 State 1.1 to 1.2

Herbivory pressure in excess of normal Reference State conditions. A typical scenario is continuous spring or season-long grazing with low stocking intensity.

Constraints to recovery. Recovery is inhibited by continued herbivory pressure, reduced seedbank, and drought conditions. Annual grasses are likely in small amounts.

Context dependence. Drought and annual invasion are most likely variables to prevent restoration.

Transition T1-3 State 1.1 to 1.3

Soil-disturbance outside of the normal disturbance regime expected for this site. Examples include high intensity fire, high intensity hoof action, anthropogenic activity (e.g. mechanical or chemical treatments), rodent activity, or

frequent flooding, which includes occasional irrigation.

Constraints to recovery. Recovery is inhibited by consecutive disturbances over a relatively short time period and drought conditions. Annual grasses are likely in small amounts, increasing with each additional disturbance.

Context dependence. Drought and annual invasion are most likely variables to prevent restoration.

Transition T2-3

State 1.2 to 1.3

Soil-disturbance outside of the normal disturbance regime expected for this site. Examples include fire, high intensity hoof action, anthropogenic activity (e.g. mechanical or chemical treatments), rodent activity, or frequent flooding, which includes occasional irrigation.

Constraints to recovery. Recovery is inhibited by consecutive disturbances over a relatively short time period and drought conditions. Annual grasses are likely in small amounts, increasing with each additional disturbance.

Context dependence. Drought and annual invasion are most likely variables to prevent restoration.

Transition T2-4

State 1.2 to 1.4

Extreme herbivory resulting in removal of perennial herbaceous vegetation followed by annual invasion, typically associated with post-drought conditions. It is common for this to occur without a sagebrush killing event, resulting in the shrub/annual plant community.

Constraints to recovery. Recovery is inhibited by fire risk and annual invasion.

Context dependence. Drought and annual invasion are variables that prevent restoration.

Transition T3-4

State 1.3 to 1.4

Extreme disturbance, including catastrophic fire, drought, or other soil removal disturbance, results in removal of perennial vegetation followed by annual invasion, typically associated with post-drought conditions.

Constraints to recovery. Recovery is inhibited by fire risk and annual invasion.

Context dependence. Drought and annual invasion are variables that prevent restoration.

Land use 2

Pastureland

This is a moderately deep to deep site with very few limitations for agriculture production, and therefore is often converted to irrigated pasture due to high water holding capacity, low slopes, and landscape position that lends itself to tillage and irrigation practices. The site is also converted to dryland pasture to a lesser extent. Pastureland is land composed of introduced or domesticated native forage species that is used primarily for the production of livestock. Pastures receive periodic renovation and cultural treatments, such as tillage, fertilization, mowing, weed control, and may be irrigated. Pastures are not in rotation with crops.

Characteristics and indicators. Pasture on this site can be either dryland or irrigated. Irrigated pasture is the most common scenario and can be very diverse with a mixture of native and non-native forage species or as a monoculture of a highly competitive forage grass such as creeping meadow foxtail. Hay production with aftermath grazing is common, but pastures on this site can also be managed for grazing throughout the growing season with some dormant season grazing as well. Dryland pasture on this site is often dominated by a monoculture crested wheatgrass and used as special use pasture for spring grazing. It is common for sagebrush to re-colonize the site over time without periodic renovation or cultural practices such as mowing or tillage.

State 2.1 Irrigated Pasture State

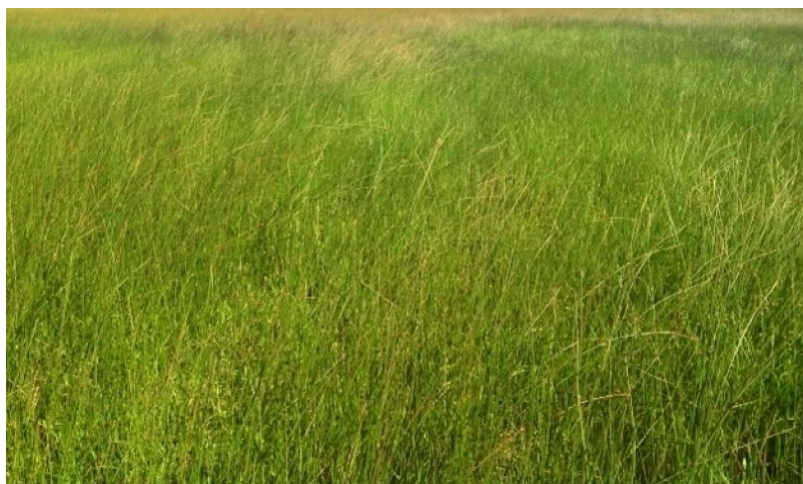

See Loamy Forage Suitability Group (FSG) for MLRA 34A LRU F (10-14" ppt, 70-90 day growing season) for more information at Wyoming's electronic Field Office Technical Guide, Section II, Forage Suitability Groups https://efotg.sc.egov.usda.gov/references/public/WY/mlra34A_fsg_loamy_lru_F_.pdf This FSG covers moderately deep to deep soils with medium soil textures and greater than 6 inches available water-holding capacity (AWC) in the top 60 inches of the soil profile. Production expected to range from 3,000 to 6,000 lbs./ac. with representative value (RV) of 4,500 lbs./ac. Adapted species for use as irrigated pasture include native species such as Idaho fescue, prairie junegrass, Canby's bluegrass, blue wildrye, slender wheatgrass, western wheatgrass, and tufted hairgrass; introduced species including meadow brome, timothy, orchardgrass, beardless wildrye, Altai wildrye, red fescue, sheep fescue, and tall fescue, creeping meadow foxtail, Canada bluegrass, and Kentucky bluegrass; forb and shrub species such as cicer milkvetch, birdsfoot trefoil, small burnett, white clover, alsike clover, red clover, and strawberry clover. Selection of species should be based on production goals and intended use (goals and objectives). More information regarding preferred varieties for irrigated pasture can be found at <http://animalrange.montana.edu/documents/extension/mteb99.pdf> AND https://www.nrcs.usda.gov/Internet/FSE_PLANTMATERIALS/publications/mtpmctn10704.pdf

Characteristics and indicators. Irrigated pasture on this site is varies from a very diverse mix of native wetland plants to a monoculture of creeping meadow foxtail. Flood irrigation water management often results in hydric soil and hydrophytic vegetation.

Resilience management. Resilience on this site when in irrigated pasture is much higher than reference state. Resistance to annual invasion is typically much higher than the reference state. However, improper grazing or irrigation water management techniques could result in noxious weed invasion by perennials such as perennial pepperweed, musk thistle, Canada thistle, or scentless chamomile.

Dominant resource concerns

- Inefficient irrigation water use

- Plant productivity and health
- Terrestrial habitat for wildlife and invertebrates

State 2.2

Dryland Pasture State

See Loamy Forage Suitability Group (FSG) for MLRA 34A LRU F (10-14" ppt, 70-90 day growing season) for more information at Wyoming's electronic Field Office Technical Guide, Section II, Forage Suitability Groups https://efotg.sc.egov.usda.gov/references/public/WY/mlra34A_fsg_loamy_lru_F_.pdf This FSG covers moderately deep to deep soils with medium soil textures and greater than 6 inches available water-holding capacity (AWC) in the top 60 inches of the soil profile. Production expected to range from 700 to 1,500 lbs./ac. with representative value (RV) of 1,100 lbs./ac. Adapted species for use as dryland pasture include native species such as Indian ricegrass, big bluegrass, basin wildrye, slender wheatgrass, and western wheatgrass; introduced species including crested wheatgrass, Russian wildrye, sheep fescue, and intermediate or pubescent wheatgrass; and forb and shrub species such as sweetclover, forage kochia, winterfat, and four-wing saltbush. Selection of species should be based on production goals and intended use (goals and objectives). More information regarding adapted species for dryland can be found at https://www.nrcs.usda.gov/Internet/FSE_PLANTMATERIALS/publications/mtpmspu1138.pdf

Characteristics and indicators. Dryland pasture on this site is typically dominated by a mono-culture of crested wheatgrass. It is common for sagebrush to re-colonize the site over time without periodic renovation or cultural practices such as mowing or tillage.

Resilience management. Resilience on this site when in dryland pasture is similar to the reference state. However, it may be lower if dominated by a monoculture that lacks diversity, resulting in a plant community that is vulnerable to drastic changes following disturbance. Resistance to annual invasion is similar to reference but could be slightly higher if planted to highly competitive species such as crested wheatgrass or Russian wildrye. However, new research from the Great Basin indicates that native seedings can be as competitive as introduced species (Ott et.al. 2019).

Dominant resource concerns

- Sheet and rill erosion
- Classic gully erosion
- Plant productivity and health
- Plant structure and composition
- Terrestrial habitat for wildlife and invertebrates
- Inadequate livestock water quantity, quality, and distribution

Transition T1-2

State 2.1 to 2.2

Irrigation abandonment results in transition from irrigated pasture to dryland pasture.

Land use 3

Cropland

This is a moderately deep to deep site with very few limitations for agriculture production, and therefore is often converted to irrigated crop due to high water holding capacity, low slopes, and landscape position that lends itself to tillage and irrigation practices. Cropland is land used primarily for the production and harvest of annual or perennial field, forage, food, fiber, horticultural, orchard, vineyard, or energy crops.

Characteristics and indicators. Crops on this site are typically irrigated. Irrigated crops are typically perennial and consist of a mixture of legume (alfalfa or clover) and a variety of cool-season perennial forage grasses in rotation with short-season annual cereal grains such as barley. The annual portion of the crop rotation is often grown as a forage (not cash) crop.

State 3.1

Irrigated Crop State

See Loamy Forage Suitability Group (FSG) for MLRA 34A LRU F (10-14" ppt, 70-90 day growing season) for more information at Wyoming's electronic Field Office Technical Guide, Section II, Forage Suitability Groups https://efotg.sc.egov.usda.gov/references/public/WY/mlra34A_fsg_loamy_lru_f_.pdf This FSG covers moderately deep to deep soils with medium soil textures and greater than 6 inches available water-holding capacity (AWC) in the top 60 inches of the soil profile. Production expected to range from 3,000 to 6,000 lbs./ac. with representative value (RV) of 4,500 lbs./ac. The most common crop rotation on this site is one to three years of annual grains with 7 to 9 years of perennial forage/hay crop. Adapted species for use as annual irrigated crop includes short-season cereal grains such as barley typically grown as a forage crop. Adapted species for use as perennial irrigated crop (hayland) includes legumes such as alfalfa, clovers, sainfoin, cicer milkvetch, and birds foot trefoil; and introduced cool-season forage grasses including meadow brome, timothy, and orchardgrass.

Characteristics and indicators. Irrigated crop on this site is varies from annual to perennial forage. Center pivot or side roll sprinklers are the most common form of irrigation, however improved flood irrigation such as graded borders also occurs.

Resilience management. Resilience on this site when in irrigated crop is typically high due to added irrigation water. Resistance to annual invasion is typically high as well. However, severe ground disturbance, improper aftermath grazing or irrigation water management techniques could result in noxious weed invasion by perennials such as perennial pepperweed, musk thistle, or Canada thistle.

Dominant resource concerns

- Sheet and rill erosion
- Ephemeral gully erosion
- Inefficient irrigation water use
- Plant productivity and health
- Terrestrial habitat for wildlife and invertebrates
- Energy efficiency of equipment and facilities
- Energy efficiency of farming/ranching practices and field operations

Conversion C1-2

Land use 1 to 2

Most range conversion to pasture occurred at the end of the 19th century and was done using horse-pulled implements and hand tools. Flood irrigation infrastructure was installed and introduced species seeded such as Kentucky bluegrass and clover. Wild flood irrigation is the most common with little control and sometimes water is checked at the bottom of fields to backup water and promote extended flooded conditions that result in more hydrophytic vegetation and hydric soil development.

Conversion C1-3

Land use 1 to 3

Most range conversion to crop occurred at the end of the 19th century and was done using horse-pulled implements and hand tools. Flood irrigation infrastructure such as graded borders were installed and introduced species seeded such as smooth brome and alfalfa in rotation with annual cereal grains such as oats and barley. The water source is surface water from the Bear River. In recent times there have been some range conversion to crop using sprinkler irrigation to improve water efficiency and control plus reduce labor. Higher value forage grasses such as meadow brome and non-bloat legumes such as sainfoin and cicer milkvetch have also been introduced into the crop rotation.

Conversion C2-3

Land use 2 to 3

In more recent times, wild flood irrigation is being converted to crop under sprinkler irrigation, resulting in the ability to grow higher value forages and legumes in rotation with annual cereal grains such as oats and barley.

Additional community tables

Table 14. Community 1.2 plant community composition

Group	Common Name	Symbol	Scientific Name	Annual Production (Kg/Hectare)	Foliar Cover (%)
Grass/Grasslike					
1	PERENNIAL MID-SIZE COOL SEASON GRASSES			202–392	
	bluebunch wheatgrass	PSSP6	<i>Pseudoroegneria spicata</i>	56–224	5–30
	Indian ricegrass	ACHY	<i>Achnatherum hymenoides</i>	0–112	0–20
	Letterman's needlegrass	ACLE9	<i>Achnatherum lettermanii</i>	11–112	1–20
	squirreltail	ELEL5	<i>Elymus elymoides</i>	11–112	1–10
	muttongrass	POFE	<i>Poa fendleriana</i>	11–56	1–10
	slender wheatgrass	ELTR7	<i>Elymus trachycaulus</i>	0–56	0–5
	needle and thread	HECO26	<i>Hesperostipa comata</i>	11–56	1–5
	prairie Junegrass	KOMA	<i>Koeleria macrantha</i>	11–56	1–5
	Sandberg bluegrass	POSE	<i>Poa secunda</i>	0–56	0–5
2	RHIZOMATOUS GRASSES			56–112	
	thickspike wheatgrass	ELLAL	<i>Elymus lanceolatus</i> ssp. <i>lanceolatus</i>	56–112	5–10
	western wheatgrass	PASM	<i>Pascopyrum smithii</i>	56–112	5–10
3	MISC. GRASSES/GRASSLIKES			56–112	
	plains reedgrass	CAMO	<i>Calamagrostis montanensis</i>	0–56	0–5
	needleleaf sedge	CADU6	<i>Carex duriuscula</i>	0–56	0–5
	Sandberg bluegrass	POSE	<i>Poa secunda</i>	11–56	1–5
Forb					
4	PERENNIAL FORBS			56–101	
	aster	SYMPH4	<i>Symphyotrichum</i>	0–56	0–5
	lupine	LUPIN	<i>Lupinus</i>	0–56	0–5
	spiny phlox	PHHO	<i>Phlox hoodii</i>	11–56	1–5
	buckwheat	ERIOG	<i>Eriogonum</i>	11–56	1–5
	tapertip hawksbeard	CRAC2	<i>Crepis acuminata</i>	0–34	0–3
	longleaf phlox	PHLO2	<i>Phlox longifolia</i>	0–34	0–3
	fleabane	ERIGE2	<i>Erigeron</i>	0–34	0–3
	hoary tansyaster	MACA2	<i>Machaeranthera canescens</i>	0–34	0–3
	bluebells	MERTE	<i>Mertensia</i>	0–34	0–3
	locoweed	OXYTR	<i>Oxytropis</i>	0–34	0–3
	beardtongue	PENST	<i>Penstemon</i>	0–34	0–3
	ragwort	SENEC	<i>Senecio</i>	0–34	0–3
	scarlet globemallow	SPCO	<i>Sphaeralcea coccinea</i>	0–34	0–3
	Munro's globemallow	SPMU2	<i>Sphaeralcea munroana</i>	0–34	0–3
	stemless mock goldenweed	STAC	<i>Stenotus acaulis</i>	0–34	0–3
	flaxleaf plainsmustard	SCLI	<i>Schoenocrambe linifolia</i>	0–34	0–3
	milkvetch	ASTRA	<i>Astragalus</i>	0–34	0–3
	western yarrow	ACMIO	<i>Achillea millefolium</i> var. <i>occidentalis</i>	0–34	0–3
	agoseris	AGOSE	<i>Agoseris</i>	0–34	0–3
	antennaria	ANTEN	<i>Antennaria</i>	0–34	0–3

	pussytoes	ANTEN	<i>Antennaria</i>	0-34	0-3
	rockcress	ARABI2	<i>Arabis</i>	0-11	0-1
	sandwort	ARENA	<i>Arenaria</i>	0-11	0-1
	sego lily	CANU3	<i>Calochortus nuttallii</i>	0-11	0-1
	Indian paintbrush	CASTI2	<i>Castilleja</i>	0-11	0-1
	pale bastard toadflax	COUMP	<i>Comandra umbellata ssp. pallida</i>	0-11	0-1
	hollyleaf clover	TRGY	<i>Trifolium gymnocarpon</i>	0-11	0-1
	clover	TRIFO	<i>Trifolium</i>	0-11	0-1
	violet	VIOLA	<i>Viola</i>	0-11	0-1
	deathcamas	ZIGAD	<i>Zigadenus</i>	0-11	0-1
	onion	ALLIU	<i>Allium</i>	0-11	0-1
	stonecrop	SEDUM	<i>Sedum</i>	0-11	0-1
	sagebrush buttercup	RAGL	<i>Ranunculus glaberrimus</i>	0-11	0-1
	western wallflower	ERAS2	<i>Erysimum asperum</i>	0-11	0-1
	ipomopsis	IPOMO2	<i>Ipomopsis</i>	0-11	0-1
	povertyweed	IVAX	<i>Iva axillaris</i>	0-11	0-1
	desertparsley	LOMAT	<i>Lomatium</i>	0-11	0-1
	cryptantha	CRYPT	<i>Cryptantha</i>	0-11	0-1
	larkspur	DELPH	<i>Delphinium</i>	0-11	0-1
5	ANNUAL FORBS			0-11	
	rockjasmine	ANDRO3	<i>Androsace</i>	0-11	0-1
	bushy bird's beak	CORA5	<i>Cordylanthus ramosus</i>	0-11	0-1
Shrub/Vine					
6	SAGEBRUSH			179-336	
	Wyoming big sagebrush	ARTRW8	<i>Artemisia tridentata ssp. wyomingensis</i>	112-336	5-15
	basin big sagebrush	ARTRT	<i>Artemisia tridentata ssp. tridentata</i>	0-336	0-15
	little sagebrush	ARARL	<i>Artemisia arbuscula ssp. longiloba</i>	0-56	0-5
7	MISC. SHRUBS			22-56	
	Gardner's saltbush	ATGA	<i>Atriplex gardneri</i>	0-56	0-5
	yellow rabbitbrush	CHVI8	<i>Chrysothamnus viscidiflorus</i>	11-56	1-5
	rubber rabbitbrush	ERNA10	<i>Ericameria nauseosa</i>	0-56	0-5
	granite prickly phlox	LIPU11	<i>Linanthus pungens</i>	0-34	0-3
	plains pricklypear	OPPO	<i>Opuntia polyacantha</i>	0-11	0-1
	bud sagebrush	PIDE4	<i>Picrothamnus desertorum</i>	0-11	0-1
	spineless horsebrush	TECA2	<i>Tetradymia canescens</i>	0-11	0-1
	shortspine horsebrush	TESP2	<i>Tetradymia spinosa</i>	0-11	0-1
	slender buckwheat	ERMIL2	<i>Eriogonum microthecum var. laxiflorum</i>	0-11	0-1
	winterfat	KRLA2	<i>Krascheninnikovia lanata</i>	0-11	0-1

Animal community

The following table lists suggested stocking rates for cattle under continuous season-long grazing under normal growing conditions with a harvest efficiency (HE) of 25 percent. These are conservative estimates that should be used only as guidelines in the initial stages of the conservation planning process. Often, the current plant

composition does not entirely match any particular plant community (as described in this ecological site description). A field visit is required to document actual plant composition and production. More precise carrying capacity estimates, considering forage preference and accessibility (slope, distance to water, etc.), should be calculated using field data, particularly when grazers other than cattle are involved. Under more intensive grazing management, improved harvest efficiencies (up to 35 percent) can result in an increased carrying capacity, but recovery time for upland sites is much longer. If distribution problems occur, stocking rates should be reduced or facilitating conservation practices (i.e., cross-fencing, water development) implemented to maintain plant health and vigor.

Stocking rates are expressed in Animal Unit Months (AUMs) which is defined as the amount of forage consumed by a 1,000 pound cow with a less than 4 month old calf at her side.

Plant Community Production (lbs./ac.) Initial Suggested Stocking Rate (AUMs/ac.)* Ac./AUM

1.1 Big Sagebrush/Bunchgrass:	800-1000-1200	0.1	10
1.2 Bunchgrass/Big Sagebrush:	800-1000-1200	0.15	7
1.3 Bunchgrass:	800-1000-1200	0.22	5
2.1 Big Sagebrush/Short-Stature Grass:	600-800-1000	0.07	14
2.2 Short-Stature Grass/Big Sagebrush:	600-800-1000	0.1	10
3.1 Big Sagebrush/Rabbitbrush:	400-700-900	0.06	17
3.2 Rabbitbrush/Rhizomatous Wheatgrass:	400-700-900	0.1	10
4.1 Big Sagebrush/Annual:	400-600-800	0.05	20
4.2 Annual:	400-600-800	0.05	20
Irrigated Pasture	3000-4500-6000	1.2	0.8
Dryland Pasture	700-1100-1500	0.3	3

* Continuous, season-long grazing by cattle under average growing conditions.

Calculation for stocking rates are as follows: Using RV values for production, take forage palatable to grazing cattle and multiply by 0.25 HE and divide by 912.5 lbs./AUM air-dry weight (ADW) to arrive at the initial suggested stocking rate in AUMs/acre.

Not all kinds of livestock or wildlife have the same forage demand as a 1000-pound lactating cow. In addition, forage demand varies within a species depending on its class, i.e., its growth rate (e.g. heifers and steers vs. mature cow), lactating and maintenance (e.g., dry cow vs cow with calf). For this reason, animal unit equivalents (AUE) are provided in the National Range & Pasture Handbook to assist with this approximate determination of forage demand based on the kind, class and size of animal (NRPH, 2003). For cattle with a different average weight than a 1000 pound average, AUE can be adjusted (i.e., every 100 pounds of animal weight equates to about 0.10 Animals Units thus a 1200-pound cow with a calf would be 1.2 AUE .

Grazing by domestic livestock is one of the major income-producing industries in the area. Rangeland in this area may provide year-long forage for cattle, sheep, or horses. During the dormant period, the forage for livestock must be supplemented with protein because the quality does not meet minimum livestock requirements.

Distance to water, shrub density, and slope can affect grazing capacity within a management unit. Accessibility adjustments should be made for the planning area as necessary. For example, 30 percent of a management unit may have 25 percent slopes and distances of greater than one mile from water, resulting in a 50 percent reduction in grazing access; therefore, the adjustment is calculated for 30 percent of the unit (i.e. 50 percent reduction on 30 percent of the management unit). Fencing, slope length, management, access, terrain, kind and class of livestock, and breeds are all factors that can increase or decrease the percent of grazing access within a management unit. Adjustments should be made that incorporate these factors when calculating the carrying capacity of a management unit.

Wildlife Interpretations:

Sagebrush grassland habitats are critically important for wildlife. The LRU provides crucial winter range for mule deer, elk, pronghorn and moose. Portions of the LRU fall within overlapping crucial winter range delineated for three species of big game. Nearly all of the LRU in Wyoming supports a designated migration corridor and numerous associated stopover habitats, where thousands of mule deer from the Wyoming Range Herd Unit move north and

south between summer and winter ranges. Healthy vegetative communities within migration stopover areas are extremely important as forage and cover where mule deer may spend several days resting and feeding to refuel before moving again. The middle segment of the LRU (east and west of the Bear River) is within sage grouse core habitat, providing breeding leks, nesting, early brood rearing, late brood rearing, and winter habitats. Maintaining intact high quality sagebrush grassland habitats with a diversity of successional stages is vitally important for meeting the needs of wildlife using this landscape.

Wildlife Habitat Threats:

Winter moisture characteristics of the BRV LRU promote environmental conditions ideal for cheatgrass establishment and persistence. Cheatgrass presence is increasing and competing with native perennial grasses and forbs to deteriorate habitat function for big game, sage grouse and other sagebrush obligate wildlife. Advanced cheatgrass invasion is expected to alter fire regimes to a short Fire Return Interval outside the natural range of variability, where sagebrush stands burn frequently resulting in a reduction of browse and cover availability for wildlife. Eventually, shrub cover dominance could revert to green (aka yellow rabbitbrush in USDA PLANTS) or rubber rabbitbrush, significantly impacting wildlife dependent on sagebrush in this landscape for survival. Current and future anthropogenic impacts to sagebrush grasslands include agriculture expansion, energy development, water storage projects, and subdivision/residential development. Increasing demand for expanding private lands hay production has seen conversion of sagebrush stands in and near sage grouse core habitat to center pivot sprinkler irrigation. Sage grouse may use these new fields during the late brood rearing period, but there is a loss of important sagebrush cover for escape, lekking, nesting, and winter cover/forage as critical life stage habitat needs for sage grouse. Energy transmission projects have recently created interest and opportunities for solar farm development in the LRU. These solar energy projects could permanently convert site specific sagebrush-grassland habitat to industrial development locations with negative cumulative impacts for sage grouse, wintering big game, and other sagebrush dependent wildlife. Aesthetic values of the Cokeville area may attract future demand for small acreage home developments, especially in the Smith's Fork River Valley and Raymond Mountain foothills. Increased fencing and sagebrush removal usually associated with residential development could be extremely detrimental to big game migration and migration stopover habitats.

Wildlife Habitat Uses:

The Big Sagebrush/Bunchgrass Plant Community, with shrub canopies ranging from 15 to 25 percent, provides transitional and/or crucial winter seasonal habitat for mule deer, elk, pronghorn and sage grouse. The combination of healthy sagebrush and herbaceous vegetation provide adequate escape and thermal cover for mule deer and preferred nesting and early brood rearing habitat for sage grouse. Sagebrush obligate bird species of Brewer's sparrow, sage thrasher, and sage sparrow depend on denser sagebrush canopies (20 percent) and sagebrush heights of 35 to 70 cm for foraging, escape cover, and nesting. Pygmy rabbits also prefer dense tall Wyoming and basin big sagebrush stands with deeper soils for burrows at the base of sagebrush plants. Wyoming big sagebrush serves as important browse for deer, elk, and pronghorn during the winter as it stands erect in deep snow, allowing ungulates relatively easy access without pawing and expenditure of energy reserves. Mountain big sagebrush and associated mixed mountain shrub species of true mountain mahogany, serviceberry, and antelope bitterbrush are found at the higher precipitation fringe areas of this zone also provide important winter browse for big game including moose. Associated under-story forbs and grasses are nutritionally important during the spring period for big game coming out of winter, and for fall migration stopover.

The Disturbed State reduces sagebrush as important wildlife cover and browse in exchange for dominance of sprouting green rabbitbrush of a lesser value for wildlife. Diversity and productivity of under-story species diminishes, with loss of bunchgrasses and increases in rhizomatous grasses and annual forbs. This transition negatively affects vertical and horizontal cover, and reduces forage values for several wildlife species, including designated sage grouse core habitat. The Invaded State exhibits sagebrush stand under-stories dominated by invasive annual grasses, particularly cheatgrass. Conversion of native perennial grasses and forbs to cheatgrass is detrimental for maintaining diverse structural cover and nutritional forage. Hiding cover and forage niches for sagebrush obligate songbirds disappears, forb and insect production for young sage grouse chicks is reduced, nutritional value of big game transitional season forage becomes inconsistent or is lost, and mid-size bunchgrass species able to stand up in deep snows as forage for wintering elk are reduced. Short Fire Return Intervals may preclude the re-establishment and persistence of sagebrush stands, negatively affecting all sagebrush dependent wildlife, especially sage grouse core habitat and thousands of migrating and wintering mule deer that use the area.

Hydrological functions

Water is the principal factor limiting forage production on this site. This site is dominated by soils in hydrologic group

B (infiltration rate of 0.15-0.3 in/hr), with localized areas in hydrologic groups A (infiltration rate of 0.3 in/hr) and C (infiltration rate of 0.05-0.15 in/hr). Infiltration ranges from rapid to moderate. Runoff potential for this site varies from low to moderate depending on soil hydrologic group and ground cover. In many cases, areas with greater than 75 percent ground cover have the greatest potential for high infiltration and lower runoff. Areas where ground cover is less than 50 percent have the greatest potential to have reduced infiltration and higher runoff (refer to Part 630, NRCS National Engineering Handbook for detailed hydrology information).

Rills and gullies are not typically present. Water flow patterns should be barely distinguishable if at all present. Pedestals are only slightly present in association with bunchgrasses and shrubs. Herbaceous litter expected to move only in short distances (to leeward side of shrubs) due to wind. Woody litter will show short movement (less than one foot) associated with large precipitation events on steeper slopes (greater than 8 percent). Chemical and physical crusts are rare to non-existent. Biological crusts are present, but only cover up to one percent of the soil surface.

Recreational uses

This site provides hunting opportunities for upland game species. The wide variety of plants which bloom in the spring have an aesthetic value that appeals to recreationists.

Inventory data references

Information presented here has been derived from historic and recent clipping data and other inventory data. Field observations from range trained personnel were also used.

Inventory Data Resources include:

14 Tier I NRCS Ecological Site Inventory (NRCS-ESI) points (1966-2018)

16 historic data sets

3 Soil Survey-ESI points (2019)

References

. 2021 (Date accessed). USDA PLANTS Database. <http://plants.usda.gov>.

. 2021 (Date accessed). USNVC [United States National Vegetation Classification]. 2019. United States National Vegetation Classification Database, V2.03. Federal Geographic Data Committee, Vegetation Subcommittee, Washington DC.. USNVC: <http://usnvc.org/>.

. 2003. National Range and Pasture Handbook (NRPH). United States Department of Agriculture, Natural Resources Conservation Service, Washington, D.C..

Bestelmeyer, B., J.R. Brown, K.M. Havstad, B. Alexander, G. Chavez, and J.E. Herrick. 2003. Development and Use of State and Transition Models for Rangelands. *Journal of Range Management* 56:114–126.

Bestelmeyer, B. and J.R. Brown. 2005. State-and-Transition Models 101: a Fresh Look at Vegetation Change.

Bestelmeyer, B., J.R. Brown, J.E. Herrick, D.A. Trujillo, and K.M. Havstad. 2004. Land Management in the American Southwest: a state-and-transition approach to ecosystem complexity. *Environmental Management* 34:38–51.

Bestelmeyer, B.T., K. Moseley, P.L. Shaver, H. Sanchez, D.D. Briske, and M.E. Fernandez-Gimenez. 2010. Practical guidance for developing state-and-transition models. *Rangelands* 32:23–30.

Bonnin, G.M., D. Martin, T. Lin, M. Parzybok, M. Yekta, and D. Riley. 2011 (Date accessed). "Precipitation-

- Briske, D.D., B.T. Bestelmeyer, T.K. Stringham, and P.L. Shaver. 2008. Recommendations for Development of Resilience-Based State-and-Transition Models. *Rangeland Ecology & Management* 61:359–367.
- Chambers, J.C., J.L. Beck, T.J. Christiansen, K.J. Clause, J.B. Dinkins, K.E. Doherty, K.A. Griffin, D.W. Havlina, K.F. Henke, L.L. Kurth, J.D. Maestas, M. Manning, K.E. Mayer, B.A. Meador, C. McCarthy, M.A. Perea, and D.A. Pyke. 2016. Using resilience and resistance concepts to manage threats to sagebrush ecosystems, Gunnison sage-grouse, and Greater sage-grouse in their eastern range: A strategic multi-scale approach.. Gen. Tech. Rep. RMRS-GTR-356.. U.S. Department of Agriculture, Forest Service, Rocky Mountain Research Station, Fort Collins, CO. 1–143.
- Chambers, J.C., D.A. Pyke, J.D. Maestas, M. Pellant, C.S. Boyd, S.B. Campbell, S. Esipinosa, D.W. Havlina, K.E. Mayer, and A. Wuenschel. 2014. Using resistance and resilience concepts to reduce impacts of invasive annual grasses and altered fire regimes on the sagebrush ecosystem and greater sage-grouse: A strategic multi-scale approach.. Gen. Tech. Rep. RMRS-GTR-326.. U.S. Department of Agriculture, Forest Service, Rocky Mountain Research Station., Fort Collins, CO. 73.
- Clause, K. and J. Randall. 2014. Wyoming Sagebrush Die-Off Report. Unpublished.
- LLC, . 2009. Greater Sage-Grouse Focused Herbaceous Monitoring of Moxa Arch Sagebrush Vegetation Treatments.
- Miller, J.F., R.H. Frederick, and R.J. Tracey. 1973. "Precipitation-Frequency Atlas of the United States" NOAA Atlas 2, Volume 5 (Idaho). National Weather Service, Silver Spring, Maryland.
- Miller, J.F., R.H. Frederick, and R.J. Tracey. 1973. "Precipitation-Frequency Atlas of the United States" NOAA Atlas 2, Volume 2 (Wyoming). National Weather Service, Silver Spring, Maryland.
- Ott, J., F.F. Kilkenney, and D.D. Summers. 2019. Long-term vegetation recovery and invasive annual suppression in native and introduced postfire seeding treatments.. *Rangeland Ecology & Management* 72:640–653.
- Schoeneberger, P.J. and D.A. Wysocki. 2017. Geomorphic Description System, Version 5.0..
- Stringham, T.K., W.C. Kreuger, and P.L. Shaver. 2003. State and Transition Modeling: an ecological process approach. *Journal of Range Management* 56:106–113.
- Winward, A. 2007. Boulder, Squaretop Area Field Notes. Field Notes. Unpublished.

Other references

Site concept, plant community data, and interpretations are based on ecological site descriptions (ESDs) from MLRA 34A-Foothills and Basins West (10-14W).
This ESD replaces R034AY222WY Loamy MLRA 34A-Foothills and Basins West (Ly 10-14W), but only within geographic extent of the Bear River Valley LRU.
Further data collection and ecological site refinement are ongoing until the ESD has reached "Approved" status.

Contributors

Bryan Christensen
Karen Clause

Approval

Kirt Walstad, 5/01/2024

Acknowledgments

Utah State University
Wyoming Game and Fish

Rangeland health reference sheet

Interpreting Indicators of Rangeland Health is a qualitative assessment protocol used to determine ecosystem condition based on benchmark characteristics described in the Reference Sheet. A suite of 17 (or more) indicators are typically considered in an assessment. The ecological site(s) representative of an assessment location must be known prior to applying the protocol and must be verified based on soils and climate. Current plant community cannot be used to identify the ecological site.

Author(s)/participant(s)	
Contact for lead author	
Date	05/01/2024
Approved by	Kirt Walstad
Approval date	
Composition (Indicators 10 and 12) based on	Annual Production

Indicators

1. **Number and extent of rills:**

2. **Presence of water flow patterns:**

3. **Number and height of erosional pedestals or terracettes:**

4. **Bare ground from Ecological Site Description or other studies (rock, litter, lichen, moss, plant canopy are not bare ground):**

5. **Number of gullies and erosion associated with gullies:**

6. **Extent of wind scoured, blowouts and/or depositional areas:**

7. **Amount of litter movement (describe size and distance expected to travel):**

8. **Soil surface (top few mm) resistance to erosion (stability values are averages - most sites will show a range of values):**

9. **Soil surface structure and SOM content (include type of structure and A-horizon color and thickness):**

10. **Effect of community phase composition (relative proportion of different functional groups) and spatial distribution on infiltration and runoff:**

11. **Presence and thickness of compaction layer (usually none; describe soil profile features which may be mistaken for compaction on this site):**

12. **Functional/Structural Groups (list in order of descending dominance by above-ground annual-production or live foliar cover using symbols: >>, >, = to indicate much greater than, greater than, and equal to):**

Dominant:

Sub-dominant:

Other:

Additional:

13. **Amount of plant mortality and decadence (include which functional groups are expected to show mortality or decadence):**

14. **Average percent litter cover (%) and depth (in):**

15. **Expected annual annual-production (this is TOTAL above-ground annual-production, not just forage annual-production):**

16. **Potential invasive (including noxious) species (native and non-native). List species which BOTH characterize degraded states and have the potential to become a dominant or co-dominant species on the ecological site if their future establishment and growth is not actively controlled by management interventions. Species that become dominant for only one to several years (e.g., short-term response to drought or wildfire) are not invasive plants. Note that unlike other indicators, we are describing what is NOT expected in the reference state for the ecological site:**

17. **Perennial plant reproductive capability:**
