

Ecological site BX013X01B024 Loamy Argillic Bear River Valley 10-14" P.Z.

Last updated: 9/07/2023
Accessed: 05/17/2024

General information

Provisional. A provisional ecological site description has undergone quality control and quality assurance review. It contains a working state and transition model and enough information to identify the ecological site.

MLRA notes

Major Land Resource Area (MLRA): 013X–Eastern Idaho Plateaus

Major Land Resource Area (MLRA) 13, Eastern Idaho Plateaus, consists of approximately 5 million acres in Idaho with a small part in Utah and Wyoming, it consists of 6 Land Resource Units (LRU). These units are divisions of the MLRA based on geology, landscape, common soils, water resources and plant community potentials. The elevation ranges from approximately 4500 to 6600 feet (1370 to 2010 m) on the plateaus and foothills to as much as 9500 feet (2895 m) on the mountains. Annual precipitation ranges from 10 to 48 inches (254 to 1220 mm), with the driest areas in the Bear River Valley on the far eastern portion and the wettest areas on the mountain summits. The Fort Hall Indian Reservation and several national forests are in this MLRA, including the Caribou, Cache, and Targhee National Forests. Yellowstone and Grand Teton National Parks occur just outside the northeast boundary.

LRU notes

The Bear River Valley LRU is located on the far eastern side of MLRA 13 between the Bear River Divide and the Monte Cristo Range, from Woodruff, Utah at the southern end to Cokeville, Wyoming at the northern end. The total area of the LRU is approximately 340,000 acres. It shares a boundary with MLRA 47 - Wasatch and Uinta Mountains, 43B - Central Rocky Mountains and 46 - Northern Rocky Mountain Foothills (proposed in Wyoming). This LRU differs from the others in its geology, which is comprised mostly of alluvium and colluvium from the Stump Formation. Its weather patterns are such that the soil moisture regime is xeric, meaning there is a slight peak in winter precipitation in this LRU, with typical yearly precipitation between 10 to 15 inches (254 to 380 mm). The soil temperature regime of this LRU is frigid with mean annual soil temperatures ranging from 44 to 48 degrees Fahrenheit (6.7 to 8.8 C). The elevation range is from 5700 to 7000 feet (1730 to 2130 m). The soils in the Bear River Valley are dominated by young aged very deep soils developed from sandstone and shale parent material re-worked with recent alluvium. Soils are dominated by Alfisols with young argillic horizons and by Fluvents in more recent alluvium.

The Bear River runs through this LRU, allowing for ample amounts of irrigation water used in the lowland areas to produce hay with smaller tributaries originating from the neighboring mountains.

Classification relationships

Relationship to Other Established Classification Systems

National Vegetation Classification System (NVC):

3 Semi-Desert

3.B.1 Cool Semi-Desert Scrub & Grassland

3.B.1.Ne Western North American Cool Semi-Desert Scrub & Grassland Division

M170 Great Basin-Intermountain Dwarf Sagebrush Steppe & Shrubland Macrogroup

G308 Intermountain Low & Black Sagebrush Steppe and Shrubland Group

A3221 Alkali Sagebrush Steppe & Shrubland Alliance

CEGL005997 *Artemisia arbuscula* ssp. *longiloba*/*Poa fendleriana* Shrubland Association

Ecoregions (EPA):

Level I: 10 North American Deserts

Level II: 10.1 Cold Deserts

Level III: 10.1.4 Wyoming Basin

Ecological site concept

Loamy Argillic Bear River Valley 10-14" P.Z. (LyA-BRV) is an upland ecological site with loamy surface textures (<32% clay content) ranging from 2-6 inches (5-15 cm) deep over a strong argillic subsurface layer (>35% clay content) starting within the top 20 inches (50 cm) that limits permeability, creating saturated conditions during spring snowmelt, but extremely dry conditions later in the growing season and with somewhat restricted water holding capacity (moderately deep to very deep with <6" AWC).

- This site does not receive any additional water; however, this site is driven by slow permeability resulting in saturated conditions during spring snow melt followed by extremely dry conditions later in the growing season.

- These soils are:

- o not saline or sodic

- o moderately deep or deep with less than 15% stone and boulder cover

- o not typically skeletal within 20 inches (50 cm) of soil surface

- o not typically violently effervescent within 20 inches (50 cm) of soil surface

- o with surface textures including fine sandy loam, loam, sandy clay loam, and clay loam with less than 32% clay content from 2-6 inches (5-15 cm) deep

- have slopes less than 30 percent

- have a strong argillic subsurface layer (>35% clay content) beginning within the top 20 inches (50 cm); the clay increase from the surface to subsurface layer ranges from 10-25% and is often >20% (i.e. 20% clay content at the surface will have 40% clay content in the subsurface layer)

Climate:

xeric moisture regime

frigid temperature regime

Associated sites

BX013X01B022	Loamy Bear River Valley 10-14" P.Z. This site can have similar surface texture, but it does not have a strong clay increase content in the subsoil, even though it may have an argillic horizon. Production and species composition potential are very different.
BX013X01B030	Overflow Bear River Valley 10-14" P.Z. This site is found in adjacent run-in landform positions and has a different plant production and species composition potential

Similar sites

R034AY258WY	Shallow Clayey Foothills and Basins West (SwCy) Previous version of this site used in Wyoming
BX013X01B004	Clayey Bear River Valley 10-14" P.Z. This site has high clay content throughout the soil profile and has a different plant production and species composition potential.

Table 1. Dominant plant species

Tree	Not specified
Shrub	(1) <i>Artemisia arbuscula ssp. longiloba</i>
Herbaceous	(1) <i>Poa fendleriana</i>

Legacy ID

R013XA124WY

Physiographic features

This site occurs on hillslope, alluvial fan, and fan remnant landforms at elevations between 5,700 and 7,000 feet. This site occurs on all aspects. The slopes range from level to 30 percent. Runoff potential is medium to high, and flooding and ponding do not typically occur on this site. Saturated soil conditions in the spring are common.

Landscape Definition:

hills -- A landscape dominated by hills and associated valleys.

valley -- An elongate, relatively large, externally drained depression of the Earth's surface that is primarily developed by stream erosion or glacial activity.

Landform Definition:

alluvial fan--A low, outspread mass of loose materials and/or rock material, commonly with gentle slopes. It is shaped like an open fan or a segment of a cone. The material was deposited by a stream at the place where it issues from a narrow mountain valley or upland

valley, or where a tributary stream is near or at its junction with the main stream. The fan is steepest near its apex, which points upstream and slopes gently and convexly outward (downstream) with a gradual decrease in gradient.

hillslope -- A generic term for the steeper part of a hill between its summit and the drainage line, valley flat, or depression floor at the base of the hill.

fan remnant -- A general term for landforms that are the remaining parts of older, non-active fan- landforms, such as alluvial fans, fan aprons, inset fans, and fan skirts, that either have been dissected (erosional fan-remnants) or partially buried (non-buried fan-remnants). An erosional fan remnant must retain a relatively flat summit that is a relict fan-surface (greater than 50 percent intact). A non-buried fan-remnant is a relict surface in its entirety. Similar terms are eroded fan remnant, eroded fan remnant sideslope, ballena.

Table 2. Representative physiographic features

Landforms	(1) Hills > Hillslope (2) Alluvial fan (3) Valley > Fan remnant
Runoff class	Medium to high
Flooding frequency	None
Ponding frequency	None
Elevation	1,737–2,134 m
Slope	0–30%
Water table depth	152 cm
Aspect	Aspect is not a significant factor

Climatic features

Annual precipitation in the Bear River Valley ranges from 10 to 14 inches per year. Wide fluctuations may occur in yearly precipitation and result in more below average years than those with above average precipitation.

Temperatures show a wide range between summer and winter and between daily maximums and minimums. This is predominantly due to the high elevation and dry air, which permits rapid incoming and outgoing radiation. Cold air outbreaks in winter move rapidly from northwest to southeast and account for extreme minimum temperatures.

Roughly 25 to 30 percent of the precipitation occurs during the critical growth period, but the majority of precipitation accumulates outside the growing season, creating xeric-like conditions. The wettest rainfall month is May. The dominant plants (sagebrush and cool season grasses) are well adapted to these conditions. Daytime winds are generally stronger than nighttime and occasional strong storms may bring brief periods of high winds with gusts to more than 50 mph. The growing season is short (60 to 90 days) and cool (critical growth period): primary growth typically occurs between May and June. Growth of native cool-season plants begins about mid-April and continues to approximately early July. Some green-up of cool-season plants usually occurs in September with adequate fall moisture.

All data is based on the 30 year average from 1981 through 2010.

Table 3. Representative climatic features

Frost-free period (characteristic range)	40-90 days
Freeze-free period (characteristic range)	50-110 days
Precipitation total (characteristic range)	254-356 mm
Frost-free period (actual range)	35-90 days
Freeze-free period (actual range)	30-110 days
Precipitation total (actual range)	203-406 mm
Frost-free period (average)	60 days
Freeze-free period (average)	80 days
Precipitation total (average)	305 mm

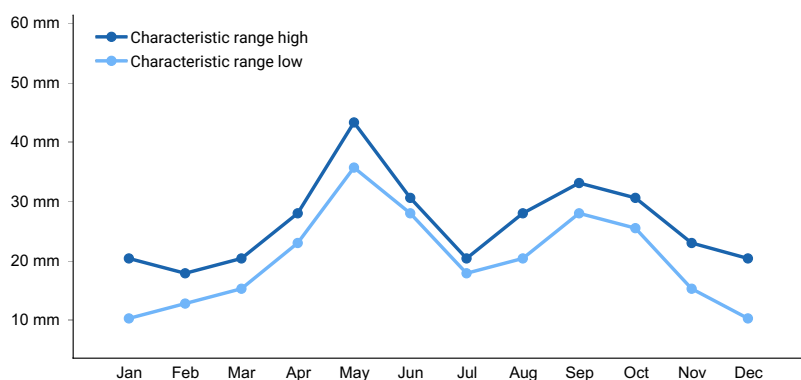

Figure 1. Monthly precipitation range

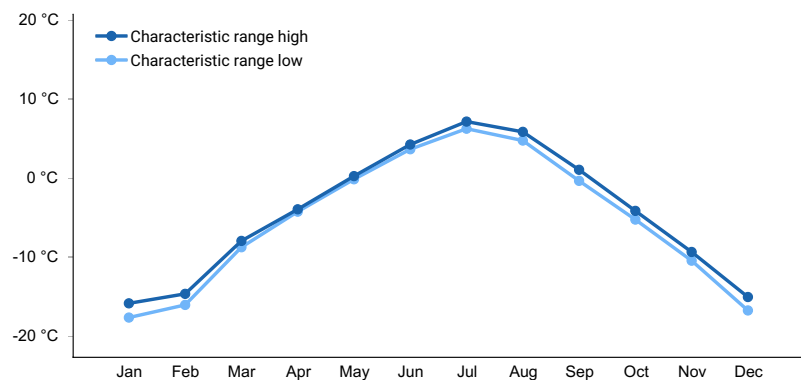

Figure 2. Monthly minimum temperature range

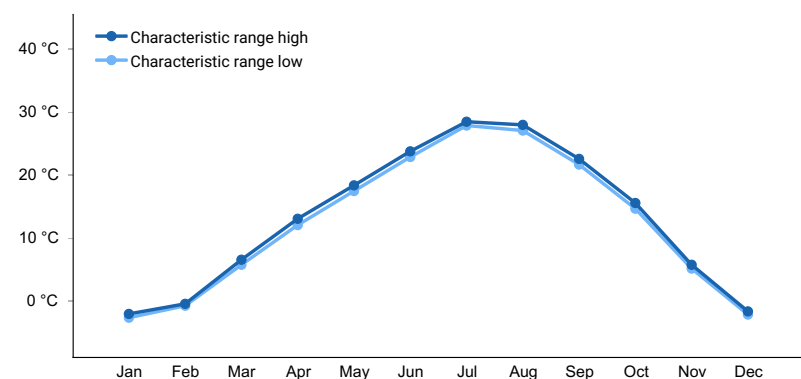

Figure 3. Monthly maximum temperature range

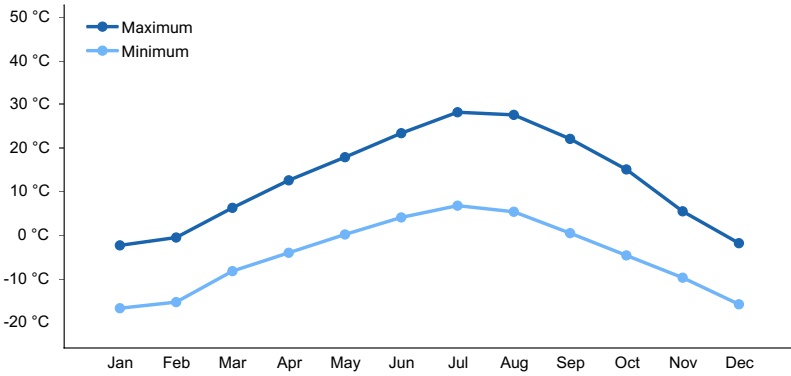

Figure 4. Monthly average minimum and maximum temperature

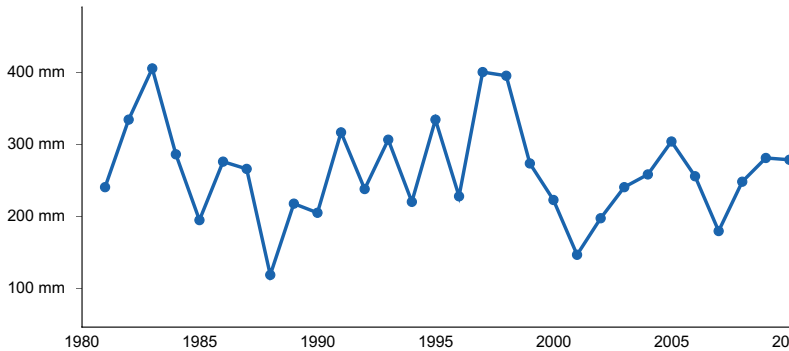

Figure 5. Annual precipitation pattern

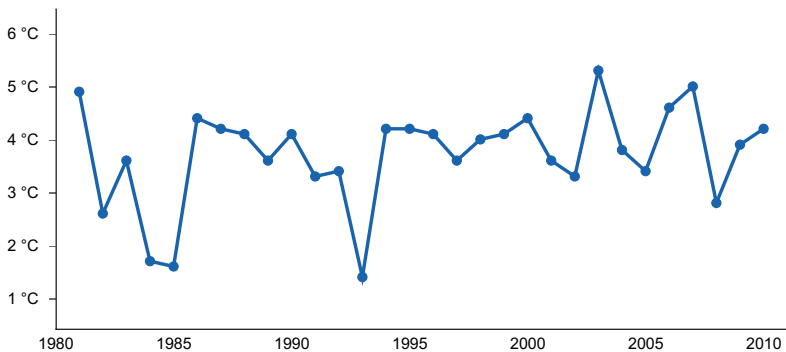

Figure 6. Annual average temperature pattern

Climate stations used

- (1) WOODRUFF [USC00429595], Woodruff, UT
- (2) RANDOLPH [USC00427165], Randolph, UT
- (3) SAGE 4 NNW [USC00487955], Cokeville, WY

Influencing water features

There are no influencing water features associated with this ecological site.

Wetland description

N/A

Soil features

The soils of this site are moderately deep to deep (20 to 60 inches) with loamy surface textures (less than 32 percent clay content) ranging from 2 to 6 inches (5 to 15 cm) deep over a strong argillic subsurface layer (greater than 35 percent clay content) starting within the top 20 inches (50 cm) that limits permeability. They are typically

well-drained soils formed in alluvium, and slope alluvium with 10 to 32 percent surface clay content and 35 to 50 percent subsurface clay content. Permeability is moderately slow to very slow, resulting in saturated soil conditions during spring runoff followed by extremely dry conditions later in the growing season. with restricted permeability and somewhat restricted water holding capacity (moderately deep to very deep with less than 6 inches AWC).

Major soil series correlated to this site includes: Stoffer

Taxonomy: Fine, smectic, frigid Calcixerepts

Table 4. Representative soil features

Parent material	(1) Slope alluvium–sandstone and shale (2) Colluvium–sandstone and shale
Surface texture	(1) Clay loam (2) Loam (3) Sandy clay loam (4) Fine sandy loam
Drainage class	Well drained
Permeability class	Moderately slow to very slow
Depth to restrictive layer	53–152 cm
Soil depth	51–152 cm
Surface fragment cover <=3"	5–15%
Surface fragment cover >3"	0–10%
Available water capacity (0-101.6cm)	11.43–15.24 cm
Calcium carbonate equivalent (0-50.8cm)	0–15%
Clay content (0-15.2cm)	10–32%
Electrical conductivity (0-50.8cm)	0–2 mmhos/cm
Sodium adsorption ratio (0-50.8cm)	0–3
Soil reaction (1:1 water) (0-50.8cm)	7.5–8
Subsurface fragment volume <=3" (25.4-152.4cm)	5–15%
Subsurface fragment volume >3" (25.4-152.4cm)	0–10%

Ecological dynamics

A State-and-Transition Model (STM) diagram is depicted in this section. Thorough descriptions of each state, transition, plant community phase, and pathway are found after the model in this document. This diagram is based on available experimental research, field observations, professional consensus, and interpretations. While based on the best available information, the STM will change over time as knowledge of ecological processes increases.

Plant community composition within the same ecological site has a natural range of variability across the LRU due to the naturally occurring variability in weather, soils, and aspect. Not all managers will choose the Reference Plant Community as the management goal. Other plant communities may be desired to meet land management objectives. This is valid as long as the rangeland health attributes assessment departures are none to slight or slight to moderate from the Reference State. The biological processes on this site are complex; therefore,

representative values are presented in a land management context. The species lists are representative and are not botanical descriptions of all species occurring, or potentially occurring, on this site. They are not intended to cover every situation or the full range of conditions, species, and responses for the site.

Both percent species composition by weight and percent cover are used in this ESD. Most observers find it easier to visualize or estimate percent cover for woody species (trees and shrubs). Foliar cover is used to define plant community phases and states in the State-and-Transition Model. Cover drives the transitions between communities and states because of the influence of shade and interception of rainfall.

Species composition by dry weight remains an important descriptor of the herbaceous community and of site productivity as a whole and includes both herbaceous and woody species. Calculating similarity index requires data on species composition by dry weight.

Although there is considerable qualitative experience supporting the pathways and transitions within the State-and-Transition Model, no quantitative information exists that specifically identifies threshold parameters between reference states and degraded states in this ecological site. For information on STMs, see the following citations: Bestelmeyer et.al. 2003, Bestelmeyer et.al. 2004, Bestelmeyer et.al. 2010, Bestelmeyer and Brown 2005, Briske et.al. 2008, and Stringham et.al. 2003.

A resource concern risk assessment and dominant resource concerns are provided for each Land Use, State, and/or Plant Community Phase based on NRCS resource concern and planning criteria used to determine resource treatment levels during the conservation planning process. A resource concern is the resource condition that does not meet the minimum accepted levels established by planning criteria as shown in Section III of the NRCS Field Office Technical Guide (<https://efotg.sc.egov.usda.gov/#/>).

- Low risk means a low probability for the category of resource concerns and additional assessment is typically not necessary.
- Medium risk means that the category of resource concerns could occur, and additional assessment is recommended if the identified resource is a client concern and/or objective.
- High risk means that a resource concern in that category is likely to occur.

The resource categories are: S (soil), W (water), A (air), P (plant), A (animal), E (energy), and H (human). The dominant resource concerns further refine the resource category to a specific resource concern within that category.

State and transition model

Ecosystem states

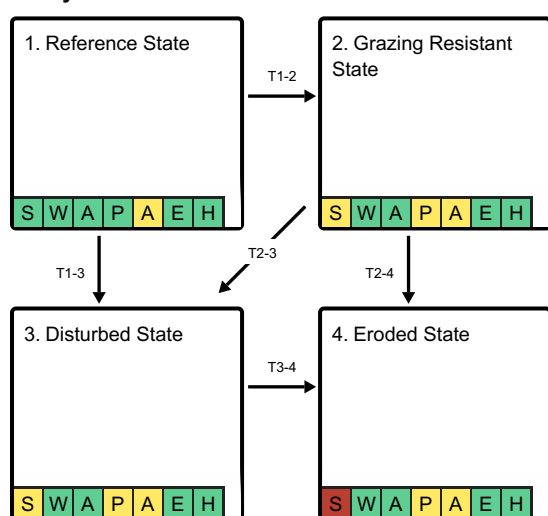

T1-2 - Herbivory (continuous or season-long, low to moderate stocking)

T1-3 - Soil disturbance (e.g. hoof action, rodents, water erosion or flooding)

T2-3 - Soil disturbance (e.g. hoof action, rodents, water erosion)

T2-4 - Extreme herbivory (continuous, high intensity)

T3-4 - Extreme disturbance (e.g. catastrophic fire, drought, soil removal)

State 1 submodel, plant communities

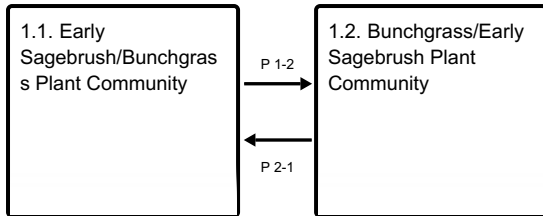

P 1-2 - Sage-thinning event (prolonged soil saturation, drought, freeze-kill, snow mold, herbivory)

P 2-1 - Natural Succession

State 2 submodel, plant communities

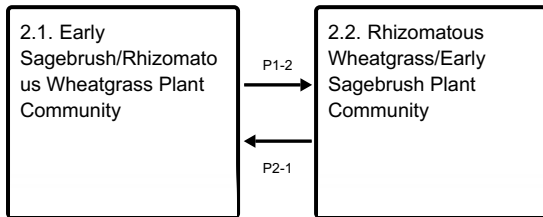

P1-2 - Sage-killing event (prolonged soil saturation, herbivory, severe drought, freeze-kill, snow mold)

P2-1 - Natural Succession

State 3 submodel, plant communities

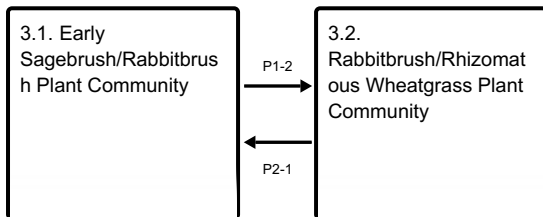

P1-2 - Sage-killing event (catastrophic wildfire or mechanical treatments)

P2-1 - Natural Succession

State 4 submodel, plant communities

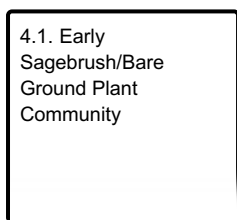

State 1 Reference State

The Reference State consists of two communities: the Early Sagebrush/Bunchgrass Community (1.1.1), and the Bunchgrass/Early Sagebrush Community (1.1.2). Each community differs in percent composition of bunchgrasses and percent shrub canopy cover. Shrub canopy cover is typically less than 25 percent. The dominant shrub species is early sagebrush. Forbs are a minor component on this site, and many are ephemeral, quickly performing their life cycle during favorable conditions in the spring. Some forb species may also experience prolonged dormancy during drought (Lesica and Steele 1994), making trend monitoring on this site difficult. Two important processes occur in the reference state and result in plant community changes: 1) sagebrush-killing disturbances such as herbivory, drought, and prolonged soil saturation; and 2) time without those disturbances, generally referred to as "natural succession."

Characteristics and indicators. The shift between plant community phases is dependent upon sagebrush-killing

disturbances, and without them it will increase even with proper grazing management. Improper grazing management may accelerate the rate of increase for the shrub component. Management actions or treatments are not prescribed or used to mimic the natural disturbance regime due to fragile nature of the soils and lower productivity potential on this site. Prescribed fire is not used due to land use and ownership patterns and lack of fine fuels (Clause and Randall 2014).

Resilience management. This site has moderate resilience due to its xeric soil moisture regime and frigid temperature regime (Chambers et.al. 2014). Precipitation is typically adequate and more effective with cooler temperatures, but timing of precipitation lowers resilience. Moisture is often not present when needed to support recovery efforts. The site can usually recovery after disturbance but is susceptible to delays in recovery during extreme climatic events such as drought. The site has moderately low resistance to invasion by annual grasses because of climate suitability. Winter precipitation patterns favor annual invasion while cooler temperatures provide some resistance. The site is susceptible to invasion during hotter climatic periods. At the LRU scale, this site is less resilient than Sandy, Loamy, or Clayey ecological sites, but is more resistant to invasion by annual invasive grasses. Lower resiliency and higher resistance is caused by heavier soil textures and reduced infiltration, making this site more susceptible to dry and drought conditions and harder for new plants to become established.

Dominant plant species

- little sagebrush (*Artemisia arbuscula ssp. longiloba*), shrub
- Indian ricegrass (*Achnatherum hymenoides*), grass
- squirreltail (*Elymus elymoides*), grass

Dominant resource concerns

- Terrestrial habitat for wildlife and invertebrates
- Inadequate livestock water quantity, quality, and distribution

Community 1.1

Early Sagebrush/Bunchgrass Plant Community

The Early Sagebrush/Bunchgrass Plant Community is well adapted to Eastern Idaho Plateaus climatic conditions. The diversity in plant species allows for drought tolerance, and natural plant mortality is very low. These plants have strong, healthy root systems that allow production to increase significantly with favorable moisture conditions. The Early Sage/Bunchgrass Community (1.1.1) is dominated by early sagebrush and mid-stature cool-season bunchgrasses (e.g. mutton bluegrass, Indian ricegrass, and Letterman's needlegrass). Forbs are a minor component, but include a wide variety of "ephemeral" forbs commonly found on wetter sites that exhibit prolonged dormancy during dry years. The Early Sagebrush/Bunchgrass Community (1.1.1) generally occurs on the Loamy Argillic site in areas where proper grazing management practices have been implemented over a long period, in combination with favorable climate conditions. Historically, these were most often areas with limited livestock access due to topography or long distances to water. The Early Sagebrush/Bunchgrass Community can be maintained through the implementation of properly managed grazing that provides adequate growing-season deferment to allow for establishment and recovery of mid-stature cool-season bunchgrasses. This plant community provides for soil stability and a properly functioning hydrologic cycle. Adequate plant litter is available for soil building and moisture retention. Plant litter is properly distributed with very little movement off-site. There are generally few canopy gaps, and most basal gaps are small (one to two feet). Rock cover on the soil surface is essentially nonexistent. Many plant inter-spaces have canopy or litter cover. Production of grasses is lower than in the Bunchgrass/Early Sagebrush Community (1.1.2).

Table 5. Annual production by plant type

Plant Type	Low (Kg/Hectare)	Representative Value (Kg/Hectare)	High (Kg/Hectare)
Shrub/Vine	224	336	448
Grass/Grasslike	179	269	359
Forb	45	67	90
Total	448	672	897

Table 6. Ground cover

Tree foliar cover	0%
Shrub/vine/liana foliar cover	20-30%
Grass/grasslike foliar cover	20-25%
Forb foliar cover	1-5%
Non-vascular plants	0%
Biological crusts	0%
Litter	20-50%
Surface fragments >0.25" and <=3"	1-10%
Surface fragments >3"	0-5%
Bedrock	0%
Water	0%
Bare ground	20-30%

Table 7. Soil surface cover

Tree basal cover	0%
Shrub/vine/liana basal cover	1-5%
Grass/grasslike basal cover	1-5%
Forb basal cover	0-1%
Non-vascular plants	0%
Biological crusts	0%
Litter	30-50%
Surface fragments >0.25" and <=3"	5-15%
Surface fragments >3"	0-10%
Bedrock	0%
Water	0%
Bare ground	20-30%

Community 1.2

Bunchgrass/Early Sagebrush Plant Community

The Bunchgrass/Early Sagebrush Community (1.1.2) can occur across the entire ecological site on a given landscape but more likely occurs in a mosaic pattern associated with the disturbance cycle at any given location. Bunchgrasses and early sagebrush share dominance in the Bunchgrass/Early Sagebrush Community (1.1.2). Canopy gaps are generally larger than basal gaps, and most basal gaps are short (less than 3 feet). Rock cover on the soil surface is essentially nonexistent. Many plant inter-spaces have canopy or litter cover. Production of grasses is higher than in the Early Sagebrush/Bunchgrass Community (1.1.1). Infiltration is still high due to high ground cover.

Table 8. Annual production by plant type

Plant Type	Low (Kg/Hectare)	Representative Value (Kg/Hectare)	High (Kg/Hectare)
Grass/Grasslike	269	404	538
Shrub/Vine	135	202	269
Forb	45	67	90
Total	449	673	897

Table 9. Ground cover

Tree foliar cover	0%
Shrub/vine/liana foliar cover	10-20%
Grass/grasslike foliar cover	30-35%
Forb foliar cover	1-5%
Non-vascular plants	0%
Biological crusts	0%
Litter	20-50%
Surface fragments >0.25" and <=3"	1-10%
Surface fragments >3"	0-5%
Bedrock	0%
Water	0%
Bare ground	20-30%

Table 10. Soil surface cover

Tree basal cover	0%
Shrub/vine/liana basal cover	0-1%
Grass/grasslike basal cover	1-5%
Forb basal cover	1-5%
Non-vascular plants	0%
Biological crusts	0%
Litter	30-50%
Surface fragments >0.25" and <=3"	5-15%
Surface fragments >3"	0-10%
Bedrock	0%
Water	0%
Bare ground	20-30%

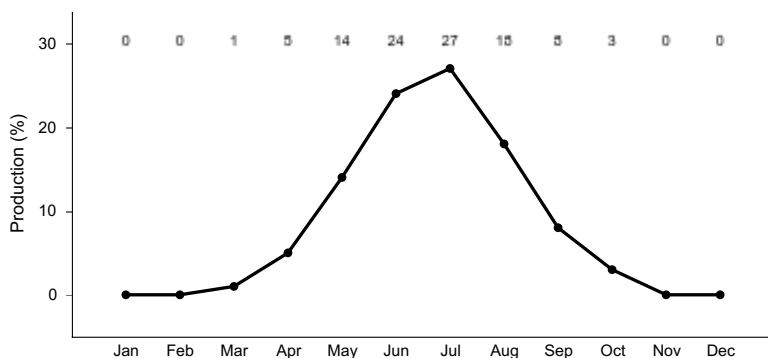

Figure 9. Plant community growth curve (percent production by month). WY13X01Bu, MLRA 13-Bear River Valley-upland. Forage Production (herbaceous only) Developed by using the Rangeland Analysis Platform (RAP).

Pathway P 1-2 Community 1.1 to 1.2

Sagebrush thinning event via climatic events such as prolonged soil saturation, drought, freeze-kill, snow mold, and herbivory.

Context dependence. The disturbance regime is very infrequent and episodic, typically with long time periods between disturbances. A successful pathway is contingent upon a grazing regime that allows for periodic critical growth period rest (May through June). Anthropogenic disturbance is not common due to low potential for economic return, nor does it result in this pathway.

Conservation practices

Prescribed Grazing

Pathway P 2-1 Community 1.2 to 1.1

Natural succession (time without sagebrush killing event).

Context dependence. Time period for pathway is dependent upon weather events such as drought and above normal precipitation years. Drought results in slower pathway while favorable precipitation can result in a faster pathway. A grazing regime that mimics the historic regime (light intensity, episodic grazing events) will not alter the pathway, but a continuous grazing regime at moderate to heavy intensity can accelerate the pathway.

State 2 Grazing Resistant State

The Grazing Resistant State (1.2) is characterized by early sagebrush dominance with an herbaceous layer dominated by Sandberg bluegrass, rhizomatous wheatgrasses, and a varying shrub component. Mutton bluegrass, Indian ricegrass and Letterman's needlegrass have become scarce or absent. This state has one plant community, Early Sagebrush/Rhizomatous Wheatgrass Plant Community (1.2.1).

Characteristics and indicators. The site crosses the threshold to the Grazing Resistant State (1.2) from the Reference State (1.1) when desirable mid-stature grasses lose dominance. Once the key species become scarce, it is unlikely that they have sufficient reproductive capability (seed source, tillering, or re-sprouting) to recover dominance in a reasonable time frame without extra energy being added to the system. Minor soil degradation often occurs to prevent restoration to the Reference State. The Grazing Resistant State is very resistant to change, and therefore common on Loamy Argillic sites in this MLRA. In many cases, the transition to the Grazing Resistant State may have occurred many decades ago during the era of high stocking rates and continuous grazing. While dominance by rhizomatous grasses makes the return to the Reference State difficult, it also makes the site resistant to further degradation. Sandberg bluegrass and rhizomatous wheatgrasses are low in stature and highly grazing tolerant. Rhizomatous species can form mats that provide soil protection by protecting the soil from raindrop impact, decreasing the risk of further soil erosion. However, overall soil health is lower than the reference state, primarily due to a reduction in soil organic matter and minor soil losses and degradation. Reduced soil organic matter is due to a reduction in litter. Decreased infiltration is due to shallower rooting depths and increased runoff. High intensity continuous or early season grazing puts this State at risk of transition to the Eroded State.

Resilience management. Site resilience is lower than the Reference State. Site hydrology has been modified due to moisture being utilized by shallower rooting species. Therefore, the site is drier earlier in the season and unable to recover as quickly after a disturbance. This state is more drought-prone, and therefore more vulnerable to invasion by annual invasive species. However, existing sagebrush canopy and remnant perennial vegetation provide some amount of resiliency. Rhizomatous grasses form mats that provide soil protection by protecting the soil from raindrop impact, decreasing the risk of soil erosion. However, overall soil stability is lower than the

Reference State, primarily due to a reduction in soil organic matter due to a reduction in litter. Site resistance to invasion by annual grasses is similar to the Reference State, although there are more niches for plants to become established during favorable conditions.

Dominant plant species

- little sagebrush (*Artemisia arbuscula* ssp. *longiloba*), shrub
- western wheatgrass (*Pascopyrum smithii*), grass
- thickspike wheatgrass (*Elymus lanceolatus* ssp. *lanceolatus*), grass
- Sandberg bluegrass (*Poa secunda*), grass

Dominant resource concerns

- Sheet and rill erosion
- Classic gully erosion
- Plant productivity and health
- Plant structure and composition
- Terrestrial habitat for wildlife and invertebrates
- Feed and forage imbalance
- Inadequate livestock water quantity, quality, and distribution

Community 2.1

Early Sagebrush/Rhizomatous Wheatgrass Plant Community



This plant community is characterized by dense stand of early sagebrush with an herbaceous component dominated by Sandberg bluegrass, rhizomatous wheatgrass and mat-forming forbs such as Hoods' phlox, with few mid-stature bunchgrasses. Once the mid-stature species become scarce, it is unlikely there will be sufficient reproductive capability (seed source, tillering, or re-sprouting) to recover dominance in a reasonable time frame. The plant community is highly resistant to changes in composition, due to the dominance and competition of established grazing tolerant species. Therefore, this plant community is very common on the landscape. This community is shrub dominated. Early sagebrush canopy may be greater than 25 percent. The Early Sagebrush/Rhizomatous Wheatgrass Plant Community occurs if the herbaceous component has been degraded. Areas that catch and retain snow are more likely to have higher shrub cover. Total annual production is lower than in Reference State (1.1), leading to lower soil organic matter content and therefore lower soil stability than in the Reference State. Total annual production ranges from 200 to 600 pounds per acre (lbs/ac) with a RV of 400 lbs/ac. Ground cover is still relatively high. Infiltration is lower than in the Reference State and the water cycle has reduced function due to decreased soil organic matter and minor soil losses. Productivity is highly variable and fluctuates drastically in response to drought and wet cycles. Biotic integrity is affected by the change in functional/structural group dominance and overall productivity.

Community 2.2

Rhizomatous Wheatgrass/Early Sagebrush Plant Community

This plant community is characterized by an herbaceous component dominated by Sandberg bluegrass,

rhizomatous wheatgrass and mat-forming forbs such as Hoods' phlox, with few mid-stature bunchgrasses. Once the mid-stature species become scarce, it is unlikely there will be sufficient reproductive capability (seed source, tillering, or re-sprouting) to recover dominance in a reasonable time frame. The plant community is highly resistant to changes in composition, due to the dominance and competition of established grazing tolerant species. Early sagebrush canopy is typically less than 15 percent, resulting from some kind of mortality event. Total annual production is lower than in Reference State (1.1), leading to lower soil organic matter content and therefore lower soil stability than in the Reference State. Total annual production ranges from 200 to 600 pounds per acre (lbs/ac) with a RV of 400 lbs/ac. Ground cover is still relatively high. Infiltration is lower than in the Reference State and the water cycle has reduced function due to decreased soil organic matter and minor soil losses. Productivity is highly variable and fluctuates drastically in response to drought and wet cycles. Biotic integrity is affected by the change in functional/structural group dominance and overall productivity.

Pathway P1-2

Community 2.1 to 2.2

Sagebrush killing event via natural climatic events such as prolonged soil saturation, severe drought, freeze-kill, or snow mold. Fire is not typically a driver in this state due to the lack of fine fuels in the under-story. Anthropogenic treatments are not common due to low potential for economic return.

Context dependence. The disturbance regime is very infrequent and episodic, typically with long time periods between disturbances. This pathway relies upon close to normal precipitation and temperature as well as a grazing regime that is low to moderate intensity. If extreme conditions/disturbances such as hot temperatures, drought, or high intensity grazing occur, there is risk of a transition to the Disturbed State depending upon severity and cumulative disturbance.

Pathway P2-1

Community 2.2 to 2.1

Natural succession (time without sagebrush killing event).

Context dependence. Time period for pathway is dependent upon weather events such as drought and above normal precipitation years. Drought results in slower pathway while favorable precipitation can result in a faster pathway. A grazing regime that mimics the historic regime (light intensity, episodic grazing events) will not alter the pathway, but a continuous grazing regime at moderate to heavy intensity can accelerate the pathway.

State 3

Disturbed State

The Disturbed State is a result of soil-disturbing activities outside of the normal disturbance regime expected for this site. Examples are high intensity hoof action, anthropogenic activity, rodent activity, or frequent flooding, which includes occasional irrigation. It may also occur after high intensity wildfire or mechanical brush management preceded or followed by improper grazing techniques that include high-intensity grazing use without appropriate recovery periods. Mechanical brush management treatment methods include heavy equipment for construction or mowing, chaining, or harrowing type sage treatment. Catastrophic wildfire could be a factor in maintaining this plant community by stimulating sprouting shrubs (rabbitbrush) and killing sagebrush, although it is rare on this site due to low fine fuel production. Removal of shrubs without proper grazing management can lead to an increase in bare ground and erosion of the upper soil horizon. Consequences of this are decreased soil organic matter and soil erosion, soil crusting, and a decrease in soil surface aggregate stability.

Characteristics and indicators. There is a shift toward sprouting shrub dominance or co-dominance with big sagebrush depending on how long it has been since the disturbance(s). Green rabbitbrush is the dominant sprouting shrub. Along with a shift in shrub species, the herbaceous under-story also shifts toward more disturbance tolerant species such as western wheatgrass.

Resilience management. Site resilience is lower than the Reference State or Grazing Resistant State, but higher than the Invaded State. Site hydrology has been modified due to moisture being utilized by shallower rooting species. Therefore, the site is drier earlier in the season and unable to recover as quickly after a disturbance. However, existing sagebrush canopy and remnant perennial vegetation provide some amount of resiliency. Site

resistance to invasion by annual grasses is lower due soil disturbances that allow niches in the under-story for establishment. However, the wetter spring conditions and prolonged dry conditions during the summer and fall are not a hospitable environment.

Dominant plant species

- yellow rabbitbrush (*Chrysothamnus viscidiflorus*), shrub
- little sagebrush (*Artemisia arbuscula* ssp. *longiloba*), shrub
- western wheatgrass (*Pascopyrum smithii*), grass
- thickspike wheatgrass (*Elymus lanceolatus* ssp. *lanceolatus*), grass
- Sandberg bluegrass (*Poa secunda*), grass

Dominant resource concerns

- Sheet and rill erosion
- Classic gully erosion
- Plant productivity and health
- Plant structure and composition
- Terrestrial habitat for wildlife and invertebrates
- Feed and forage imbalance
- Inadequate livestock water quantity, quality, and distribution

Community 3.1

Early Sagebrush/Rabbitbrush Plant Community

This plant community is a result of recovery after a past soil-disturbing activity. It is co-dominated by sprouting shrubs, mainly green rabbitbrush (aka yellow rabbitbrush in USDA PLANTS) and early sagebrush. The understory typically consists of primarily rhizomatous grasses. Total annual production ranges from 200 to 600 pounds per acre (lbs/ac) with a RV of 400 lbs/ac. The soil is typically adequately protected, but erosion can occur during high runoff events or directly after disturbance. The biotic integrity is reduced due to low vegetative production, relative dominance and unexpected structural/functional groups. The watershed is functioning-at-risk.

Community 3.2

Rabbitbrush/Rhizomatous Wheatgrass Plant Community

This plant community is the result of a recent soil-disturbing activity. Rhizomatous wheatgrasses are the dominant perennial grass along with Sandberg bluegrass. With sagebrush removed, green rabbitbrush (aka yellow rabbitbrush in USDA PLANTS) is the dominant shrub, often exceeding 30 percent of the annual production. There can be a substantial amount of bare ground. Total annual production ranges from 200 to 600 pounds per acre (lbs/ac) with a RV of 400 lbs/ac. The soil is not adequately protected, and erosion is expected without management to allow for adequate litter and residual. The biotic integrity is reduced due to low vegetative production, relative dominance and unexpected structural/functional groups. The watershed is functioning-at-risk.

Pathway P1-2

Community 3.1 to 3.2

Sagebrush killing event, typically catastrophic wildfire or consecutive anthropogenic mechanical sagebrush treatments (mowing, aerator, etc.).

Context dependence. The disturbance regime is infrequent and episodic, typically with long time periods between disturbances. If extreme conditions/disturbances such as hot temperatures, drought, or high intensity grazing occur, there is risk of a transition to the Eroded State depending upon severity and cumulative disturbance.

Conservation practices

Brush Management

Pathway P2-1

Community 3.2 to 3.1

Natural succession (time without sagebrush killing event).

Context dependence. Time period for pathway is dependent upon weather events such as drought and above normal precipitation years. Drought results in slower pathway while favorable precipitation can result in a faster pathway. A grazing regime that mimics the historic regime (light intensity, episodic grazing events) will not alter the pathway, but a continuous grazing regime at moderate to heavy intensity can accelerate the pathway.

State 4 Eroded State

This state occurs when the "A" soil horizon has been lost and the subsoil is exposed, bringing the heavy clay soil layer closer to the surface.

Characteristics and indicators. There will be indicators of reduced soil and site stability as well as reduced hydrologic function, mainly water flow patterns, pedestals, rills, and gullies. Bare ground increases along with plant gap inter-space. Soil surface loss and degradation has occurred. Biotic integrity is affected by missing functional/structural groups and the loss of species diversity within functional/structural groups. The site experiences little fluctuation in annual production from year to year because it is basically a monoculture of early sagebrush. The site is less diverse with lower quality habitat for wildlife and pollinators.

Resilience management. Site resilience is lower than all other states because the site hydrology has been modified resulting in greater runoff during spring melt and rainfall events. Therefore, the site is drier and unable to recover as quickly after a disturbance. Soil loss and degradation prevents natural regeneration or restoration of the site.

Dominant plant species

- little sagebrush (*Artemisia arbuscula ssp. longiloba*), shrub

Dominant resource concerns

- Sheet and rill erosion
- Classic gully erosion
- Organic matter depletion
- Plant productivity and health
- Plant structure and composition
- Terrestrial habitat for wildlife and invertebrates
- Feed and forage imbalance
- Inadequate livestock water quantity, quality, and distribution

Community 4.1 Early Sagebrush/Bare Ground Plant Community

Early sagebrush dominates, often greater than 60 percent species composition by dry weight. Foliar cover of sagebrush often exceeds 30 percent with the inter-spaces largely bare ground. Soil loss and degradation has occurred, resulting in a moderate or greater departure of soil site stability. Hydrologic function has been impaired due to reduced infiltration, resulting in water flow patterns, pedestalling, rills, and gullies. Total annual production ranges from 100 to 500 pounds per acre (lbs/ac) with a RV of 300 lbs/ac. The biotic integrity is reduced due to low vegetative production, relative dominance and missing structural/functional groups.

Transition T1-2 State 1 to 2

Herbivory pressure in excess of normal Reference State conditions. A typical scenario is continuous spring or season-long grazing with low stocking intensity.

Constraints to recovery. Recovery is inhibited by continued herbivory pressure, soil degradation, reduced

seedbank, and drought conditions.

Context dependence. Drought and soil degradation are the most likely variables to prevent restoration.

Transition T1-3 State 1 to 3

Soil-disturbance outside of the normal disturbance regime expected for this site. Examples include moderate or high intensity fire, high intensity hoof action, anthropogenic activity (e.g. mechanical or chemical treatments), rodent activity, or frequent flooding, which includes occasional irrigation.

Constraints to recovery. Recovery is inhibited by consecutive disturbances over a relatively short time period and drought conditions. Soil degradation contributes to low resilience of this site.

Context dependence. Drought and soil degradation are the most likely variables to prevent restoration.

Transition T2-3 State 2 to 3

Soil-disturbance outside of the normal disturbance regime expected for this site. Examples include fire, high intensity hoof action, anthropogenic activity (e.g. mechanical or chemical treatments), rodent activity, or frequent flooding, which includes occasional irrigation.

Constraints to recovery. Recovery is inhibited by consecutive disturbances over a relatively short time period and drought conditions. Soil degradation contributes to low resilience on this site.

Context dependence. Drought and soil degradation are the most likely variables to prevent restoration.

Transition T2-4 State 2 to 4

Extreme herbivory resulting in removal of perennial herbaceous vegetation, typically associated with post-drought conditions. It is common for this to occur without a sagebrush killing event, resulting in the shrub/bare ground plant community.

Constraints to recovery. Recovery is inhibited by soil degradation.

Context dependence. Drought and soil degradation are variables that prevent restoration.

Transition T3-4 State 3 to 4

Extreme disturbance, including catastrophic fire, drought, or other soil removal disturbance, resulting in removal of perennial herbaceous vegetation, typically associated with post-drought conditions.

Constraints to recovery. Recovery is inhibited by soil degradation.

Context dependence. Drought and soil degradation are variables that prevent restoration.

Additional community tables

Table 11. Community 1.2 plant community composition

Group	Common Name	Symbol	Scientific Name	Annual Production (Kg/Hectare)	Foliar Cover (%)
Grass/Grasslike					
1	PERENNIAL MID-SIZE COOL SEASON GRASSES			146–202	
	muttongrass	POFE	<i>Poa fendleriana</i>	67–202	10–30
	Indian ricegrass	ACHV	<i>Achnatherum hymenoides</i>	24–125	5–20

	Indian ricegrass	ACR1	<i>Acriatherum hymenoides</i>	34-135	5-20
	Letterman's needlegrass	ACLE9	<i>Achnatherum lettermanii</i>	34-135	5-20
	squirreltail	ELEL5	<i>Elymus elymoides</i>	34-101	5-15
	slender wheatgrass	ELTR7	<i>Elymus trachycaulus</i>	0-67	0-10
	needle and thread	HECO26	<i>Hesperostipa comata</i>	0-67	0-10
	bluebunch wheatgrass	PSSP6	<i>Pseudoroegneria spicata</i>	34-67	5-10
	prairie Junegrass	KOMA	<i>Koeleria macrantha</i>	7-67	1-10
	Sandberg bluegrass	POSE	<i>Poa secunda</i>	7-67	1-10
2	RHIZOMATOUS GRASSES			95-135	
	thickspike wheatgrass	ELLAL	<i>Elymus lanceolatus ssp. lanceolatus</i>	34-135	5-20
	western wheatgrass	PASM	<i>Pascopyrum smithii</i>	34-135	5-20
3	MISC. GRASSES/GRASSLIKES			50-67	
	plains reedgrass	CAMO	<i>Calamagrostis montanensis</i>	0-34	0-5
	needleleaf sedge	CADU6	<i>Carex duriuscula</i>	0-34	0-5
	Sandberg bluegrass	POSE	<i>Poa secunda</i>	7-34	1-5
Forb					
4	PERENNIAL FORBS			45-61	
	lupine	LUPIN	<i>Lupinus</i>	0-34	0-5
	spiny phlox	PHHO	<i>Phlox hoodii</i>	7-34	1-5
	buckwheat	ERIOG	<i>Eriogonum</i>	7-34	1-5
	aster	SYMPH4	<i>Symphotrichum</i>	0-34	0-5
	western yarrow	ACMIO	<i>Achillea millefolium var. occidentalis</i>	0-20	0-3
	agoseris	AGOSE	<i>Agoseris</i>	0-20	0-3
	ragwort	SENEC	<i>Senecio</i>	0-20	0-3
	scarlet globemallow	SPCO	<i>Sphaeralcea coccinea</i>	0-20	0-3
	stemless mock goldenweed	STAC	<i>Stenotus acaulis</i>	0-20	0-3
	tapertip hawksbeard	CRAC2	<i>Crepis acuminata</i>	0-20	0-3
	milkvetch	ASTRA	<i>Astragalus</i>	0-20	0-3
	longleaf phlox	PHLO2	<i>Phlox longifolia</i>	0-20	0-3
	pussytoes	ANTEN	<i>Antennaria</i>	0-20	0-3
	fleabane	ERIGE2	<i>Erigeron</i>	0-20	0-3
	hoary tansyaster	MACA2	<i>Machaeranthera canescens</i>	0-20	0-3
	bluebells	MERTE	<i>Mertensia</i>	0-20	0-3
	locoweed	OXYTR	<i>Oxytropis</i>	0-20	0-3
	beardtongue	PENST	<i>Penstemon</i>	0-20	0-3
	flaxleaf plainsmustard	SCLI	<i>Schoenocrambe linifolia</i>	0-20	0-3
	stonecrop	SEDUM	<i>Sedum</i>	0-7	0-1
	Indian paintbrush	CASTI2	<i>Castilleja</i>	0-7	0-1
	Douglas' dustymaiden	CHDO	<i>Chaenactis douglasii</i>	0-7	0-1
	pale bastard toadflax	COUMP	<i>Comandra umbellata ssp. pallida</i>	0-7	0-1
	rockcress	ARABI2	<i>Arabis</i>	0-7	0-1
	sandwort	ARENA	<i>Arenaria</i>	0-7	0-1

	cryptantha	CRYPT	<i>Cryptantha</i>	0-7	0-1
	larkspur	DELPH	<i>Delphinium</i>	0-7	0-1
	western wallflower	ERAS2	<i>Erysimum asperum</i>	0-7	0-1
	ipomopsis	IPOMO2	<i>Ipomopsis</i>	0-7	0-1
	bitter root	LERE7	<i>Lewisia rediviva</i>	0-7	0-1
	desertparsley	LOMAT	<i>Lomatium</i>	0-7	0-1
	sagebrush buttercup	RAGL	<i>Ranunculus glaberrimus</i>	0-7	0-1
	onion	ALLIU	<i>Allium</i>	0-7	0-1
	hollyleaf clover	TRGY	<i>Trifolium gymnocarpon</i>	0-7	0-1
	clover	TRIFO	<i>Trifolium</i>	0-7	0-1
	violet	VIOLA	<i>Viola</i>	0-7	0-1
	deathcamas	ZIGAD	<i>Zigadenus</i>	0-7	0-1
5	ANNUAL FORBS			0-7	
	rockjasmine	ANDRO3	<i>Androsace</i>	0-7	0-1
	bushy bird's beak	CORA5	<i>Cordylanthus ramosus</i>	0-7	0-1
Shrub/Vine					
6	SAGEBRUSH			56-235	
	little sagebrush	ARARL	<i>Artemisia arbuscula ssp. longiloba</i>	101-168	10-20
	Wyoming big sagebrush	ARTRW8	<i>Artemisia tridentata ssp. wyomingensis</i>	0-34	0-5
7	MISC. SHRUBS			22-34	
	Gardner's saltbush	ATGA	<i>Atriplex gardneri</i>	0-34	0-5
	yellow rabbitbrush	CHVI8	<i>Chrysothamnus viscidiflorus</i>	7-34	1-5
	slender buckwheat	ERMIL2	<i>Eriogonum microthecum var. laxiflorum</i>	0-34	0-5
	winterfat	KRLA2	<i>Krascheninnikovia lanata</i>	0-34	0-5
	granite prickly phlox	LIPU11	<i>Linanthus pungens</i>	7-34	1-5
	plains pricklypear	OPPO	<i>Opuntia polyacantha</i>	0-7	0-1

Animal community

The following table lists suggested stocking rates for cattle under continuous season-long grazing under normal growing conditions with a harvest efficiency (HE) of 25 percent. These are conservative estimates that should be used only as guidelines in the initial stages of the conservation planning process. Often, the current plant composition does not entirely match any particular plant community (as described in this ecological site description). A field visit is required to document actual plant composition and production. More precise carrying capacity estimates, considering forage preference and accessibility (slope, distance to water, etc.), should be calculated using field data, particularly when grazers other than cattle are involved. Under more intensive grazing management, improved harvest efficiencies (up to 35 percent) can result in an increased carrying capacity, but recovery time for upland sites is much longer. If distribution problems occur, stocking rates should be reduced or facilitating conservation practices (i.e., cross-fencing, water development) implemented to maintain plant health and vigor.

Stocking rates are expressed in Animal Unit Months (AUMs) which is defined as the amount of forage consumed by a 1,000 pound cow with a less than 4 month old calf at her side.

Plant Community Production (lbs./ac.) Initial Suggested Stocking Rate (AUMs/ac.)* Ac./AUM

1.1 Early Sagebrush/Bunchgrass 400-600-800 0.06 17

1.2 Bunchgrass/Early Sagebrush 400-600-800 0.08 13

2.1 Early Sagebrush/Short-stature Grass 200-400-600 0.03 33

- 2.2 Short-stature Grass/Early Sagebrush 200-400-600 0.05 20
- 3.1 Early Sagebrush/Rabbitbrush 200-400-600 0.03 33
- 3.1 Rabbitbrush/Rhizomatous Wheatgrass 200-400-600 0.05 20
- 4.1 Early Sagebrush/*Bare Ground* 100-300-500 0.01 100

* Continuous, season-long grazing by cattle under average growing conditions.

Calculation for stocking rates are as follows: Using RV values for production, take forage palatable to grazing cattle and multiply by 0.25 HE and divide by 912.5 lbs./AUM air-dry weight (ADW) to arrive at the initial suggested stocking rate in AUMs/acre.

Not all kinds of livestock or wildlife have the same forage demand as a 1000-pound lactating cow. In addition, forage demand varies within a species depending on its class, i.e., its growth rate (e.g. heifers and steers vs. mature cow), lactating and maintenance (e.g., dry cow vs cow with calf). For this reason, animal unit equivalents (AUE) are provided in the National Range & Pasture Handbook to assist with this approximate determination of forage demand based on the kind, class and size of animal (NRPH, 2003). For cattle with a different average weight than a 1000 pound average, AUE can be adjusted (i.e., every 100 pounds of animal weight equates to about 0.10 Animals Units thus a 1200-pound cow with a calf would be 1.2 AUE .

Grazing by domestic livestock is one of the major income-producing industries in the area. Rangeland in this area may provide year-long forage for cattle, sheep, or horses. During the dormant period, the forage for livestock must be supplemented with protein because the quality does not meet minimum livestock requirements.

Distance to water, shrub density, and slope can affect grazing capacity within a management unit. Accessibility adjustments should be made for the planning area as necessary. For example, 30 percent of a management unit may have 25 percent slopes and distances of greater than one mile from water, resulting in a 50 percent reduction in grazing access; therefore, the adjustment is calculated for 30 percent of the unit (i.e. 50 percent reduction on 30 percent of the management unit). Fencing, slope length, management, access, terrain, kind and class of livestock, and breeds are all factors that can increase or decrease the percent of grazing access within a management unit. Adjustments should be made that incorporate these factors when calculating the carrying capacity of a management unit.

Wildlife Interpretations:

Sagebrush grassland habitats are critically important for wildlife. The LRU provides crucial winter range for mule deer, elk, pronghorn and moose. Portions of the LRU fall within overlapping crucial winter range delineated for three species of big game. Nearly all of the LRU in Wyoming supports a designated migration corridor and numerous associated stopover habitats, where thousands of mule deer from the Wyoming Range Herd Unit move north and south between summer and winter ranges. Healthy vegetative communities within migration stopover areas are extremely important as forage and cover where mule deer may spend several days resting and feeding to refuel before moving again. The middle segment of the LRU (east and west of the Bear River) is within sage grouse core habitat, providing breeding leks, nesting, early brood rearing, late brood rearing, and winter habitats. Maintaining intact high quality sagebrush grassland habitats with a diversity of successional stages is vitally important for meeting the needs of wildlife using this landscape.

Wildlife Habitat Threats:

Winter moisture characteristics of the BRV LRU promote environmental conditions ideal for cheatgrass establishment and persistence. Cheatgrass presence is increasing and competing with native perennial grasses and forbs to deteriorate habitat function for big game, sage grouse and other sagebrush obligate wildlife. Advanced cheatgrass invasion is expected to alter fire regimes to a short Fire Return Interval outside the natural range of variability, where sagebrush stands burn frequently resulting in a reduction of browse and cover availability for wildlife. Eventually, shrub cover dominance could revert to green (aka yellow rabbitbrush in USDA PLANTS) or rubber rabbitbrush, significantly impacting wildlife dependent on sagebrush in this landscape for survival. Current and future anthropogenic impacts to sagebrush grasslands include agriculture expansion, energy development, water storage projects, and subdivision/residential development. Increasing demand for expanding private lands hay production has seen conversion of sagebrush stands in and near sage grouse core habitat to center pivot sprinkler irrigation. Sage grouse may use these new fields during the late brood rearing period, but there is a loss of important sagebrush cover for escape, lekking, nesting, and winter cover/forage as critical life stage habitat needs for sage grouse. Energy transmission projects have recently created interest and opportunities for solar farm development in the LRU. These solar energy projects could permanently convert site specific

sagebrush-grassland habitat to industrial development locations with negative cumulative impacts for sage grouse, wintering big game, and other sagebrush dependent wildlife. Aesthetic values of the Cokeville area may attract future demand for small acreage home developments, especially in the Smith's Fork River Valley and Raymond Mountain foothills. Increased fencing and sagebrush removal usually associated with residential development could be extremely detrimental to big game migration and migration stopover habitats.

Wildlife Habitat Uses:

This site supports stands of early sagebrush which is highly palatable due to the chemicals coumarin and methacrolein produced in the leaves. Early sage is an important browse species for wintering mule deer, pronghorn and elk, especially in wind swept sites with little snow cover allowing access to this low growing shrub. Due to its short stature, early sagebrush sites provide sage grouse lek sites if adjacent stands of taller sagebrush species are present for cover. Sage grouse also use wind swept early sage sites for winter forage.

Hydrological functions

Water is the principal factor limiting forage production on this site. This site is dominated by soils in hydrologic group C, with localized areas in hydrologic group D. Permeability for this site is moderately slow to very slow due to a heavy argillic horizon in a subsurface horizon. Runoff potential for this site varies from moderate to high, depending upon soil hydrologic group and ground cover. In many cases, lesser sloping areas with greater than 75 percent ground cover have the greatest potential for high infiltration and lower runoff. Greater sloping areas where ground cover is less than 50 percent have the greatest potential to have reduced infiltration and higher runoff (refer to Part 630, NRCS National Engineering Handbook for detailed hydrologic information).

Rills are rare to occasional and active gullies are rare. Water flow patterns should be barely distinguishable if at all present. Pedestals are only slightly present in association with bunchgrasses and shrubs. Herbaceous litter expected to move only in short distances (to leeward side of shrubs) due to wind. Woody litter will show short movement (less than 3 feet) associated with large precipitation events on steeper slopes (>8%). Chemical and physical crusts are sometimes present on this site.

Recreational uses

This site provides hunting opportunities for upland game species. The wide variety of plants which bloom in the spring have an aesthetic value that appeals to recreationists.

Inventory data references

Information presented here has been derived from historic and recent clipping data and other inventory data. Field observations from range trained personnel were also used.

Inventory Data Resources include:

- 1 Tier I NRCS Ecological Site Inventory (NRCS-ESI) point (2013)
- 9 historic data sets
- 1 Soil Survey-ESI point (2019)

References

- . 2021 (Date accessed). USDA PLANTS Database. <http://plants.usda.gov>.
- . 2021 (Date accessed). USNVC [United States National Vegetation Classification]. 2019. United States National Vegetation Classification Database, V2.03. Federal Geographic Data Committee, Vegetation Subcommittee, Washington DC.. USNVC: <http://usnvc.org/>.
- . 2003. National Range and Pasture Handbook (NRPH). United States Department of Agriculture, Natural Resources Conservation Service, Washington, D.C..

Bestelmeyer, B., J.R. Brown, K.M. Havstad, B. Alexander, G. Chavez, and J.E. Herrick. 2003. Development and Use of State and Transition Models for Rangelands. *Journal of Range Management* 56:114–126.

- Bestelmeyer, B., J.R. Brown, J.E. Herrick, D.A. Trujillo, and K.M. Havstad. 2004. Land Management in the American Southwest: a state-and-transition approach to ecosystem complexity. *Environmental Management* 34:38–51.
- Bestelmeyer, B. and J. Brown. 2005. State-and-Transition Models 101: A Fresh look at vegetation change.
- Bestelmeyer, B.T., K. Moseley, P.L. Shaver, H. Sanchez, D.D. Briske, and M.E. Fernandez-Gimenez. 2010. Practical guidance for developing state-and-transition models. *Rangelands* 32:23–30.
- Bonnin, G.M., D. Martin, T. Lin, M. Parzybok, M. Yekta, and D. Riley. 2011 (Date accessed). “Precipitation-Frequency Atlas of the United States” NOAA Atlas 14, Volume 1 Version 5.0. <https://hdsc.nws.noaa.gov/hdsc/pfds/>.
- Briske, D.D., B.T. Bestelmeyer, T.K. Stringham, and P.L. Shaver. 2008. Recommendations for Development of Resilience-Based State-and-Transition Models. *Rangeland Ecology & Management* 61:359–367.
- Chambers, J.C., J.L. Beck, T.J. Christiansen, K.J. Clause, J.B. Dinkins, K.E. Doherty, K.A. Griffin, D.W. Havlina, K.F. Henke, L.L. Kurth, J.D. Maestas, M. Manning, K.E. Mayer, B.A. Meador, C. McCarthy, M.A. Perea, and D.A. Pyke. 2016. Using resilience and resistance concepts to manage threats to sagebrush ecosystems, Gunnison sage-grouse, and Greater sage-grouse in their eastern range: A strategic multi-scale approach.. Gen. Tech. Rep. RMRS-GTR-356.. U.S. Department of Agriculture, Forest Service, Rocky Mountain Research Station, Fort Collins, CO. 1–143.
- Clause, K. and J. Randall. 2014. Wyoming Sagebrush Die-Off Report. Unpublished.
- Miller, J.F., R.H. Frederick, and R.J. Tracey. 1973. “Precipitation-Frequency Atlas of the United States” NOAA Atlas 2, Volume 5 (Idaho). National Weather Service, Silver Spring, Maryland.
- Miller, J.F., R.H. Frederick, and R.J. Tracey. 1973. “Precipitation-Frequency Atlas of the United States” NOAA Atlas 2, Volume 2 (Wyoming). National Weather Service, Silver Spring, Maryland.
- Peter Lesica and Brian M. Steele. July 1994. Prolonged Dormancy in Vascular Plants and Implications for Monitoring Studies. *Natural Areas Journal* 14:209–212.
- Schoeneberger, P.J. and D.A. Wysocki. 2017. Geomorphic Description System, Version 5.0..
- Stringham, T.K., W.C. Kreuger, and P.L. Shaver. 2003. State and Transition Modeling: an ecological process approach. *Journal of Range Management* 56:106–113.
- Winward, A. 2007. Boulder, Squaretop Area Field Notes. Field Notes. Unpublished.

Other references

Site concept, plant community data, and interpretations are based on ecological site descriptions (ESDs) from MLRA 34A-Foothills and Basins West (10-14W).
This ESD replaces R034AY258WY Shallow Clayey MLRA 34A-Foothills and Basins West (SwCy 10-14W), but only

within geographic extent of the Bear River Valley LRU.

Further data collection and ecological site refinement are ongoing until the ESD has reached "Approved" status.

Contributors

Bryan Christensen

Karen Clause

Approval

Kirt Walstad, 9/07/2023

Acknowledgments

Utah State University

Wyoming Game and Fish

Rangeland health reference sheet

Interpreting Indicators of Rangeland Health is a qualitative assessment protocol used to determine ecosystem condition based on benchmark characteristics described in the Reference Sheet. A suite of 17 (or more) indicators are typically considered in an assessment. The ecological site(s) representative of an assessment location must be known prior to applying the protocol and must be verified based on soils and climate. Current plant community cannot be used to identify the ecological site.

Author(s)/participant(s)	
Contact for lead author	
Date	05/17/2024
Approved by	Kirt Walstad
Approval date	
Composition (Indicators 10 and 12) based on	Annual Production

Indicators

1. **Number and extent of rills:**

2. **Presence of water flow patterns:**

3. **Number and height of erosional pedestals or terracettes:**

4. **Bare ground from Ecological Site Description or other studies (rock, litter, lichen, moss, plant canopy are not bare ground):**

5. **Number of gullies and erosion associated with gullies:**

6. **Extent of wind scoured, blowouts and/or depositional areas:**

7. **Amount of litter movement (describe size and distance expected to travel):**

8. **Soil surface (top few mm) resistance to erosion (stability values are averages - most sites will show a range of values):**

9. **Soil surface structure and SOM content (include type of structure and A-horizon color and thickness):**

10. **Effect of community phase composition (relative proportion of different functional groups) and spatial distribution on infiltration and runoff:**

11. **Presence and thickness of compaction layer (usually none; describe soil profile features which may be mistaken for compaction on this site):**

12. **Functional/Structural Groups (list in order of descending dominance by above-ground annual-production or live foliar cover using symbols: >>, >, = to indicate much greater than, greater than, and equal to):**

Dominant:

Sub-dominant:

Other:

Additional:

13. **Amount of plant mortality and decadence (include which functional groups are expected to show mortality or decadence):**

14. **Average percent litter cover (%) and depth (in):**

15. **Expected annual annual-production (this is TOTAL above-ground annual-production, not just forage annual-production):**

16. **Potential invasive (including noxious) species (native and non-native). List species which BOTH characterize degraded states and have the potential to become a dominant or co-dominant species on the ecological site if their future establishment and growth is not actively controlled by management interventions. Species that become dominant for only one to several years (e.g., short-term response to drought or wildfire) are not invasive plants. Note that unlike other indicators, we are describing what is NOT expected in the reference state**

for the ecological site:

17. **Perennial plant reproductive capability:**
