

Ecological site F025XY053NV Cottonwood Terrace

Last updated: 4/24/2024
Accessed: 05/19/2024

General information

Provisional. A provisional ecological site description has undergone quality control and quality assurance review. It contains a working state and transition model and enough information to identify the ecological site.

MLRA notes

Major Land Resource Area (MLRA): 025X—Owyhee High Plateau

MLRA Notes 25—Owyhee High Plateau

This area is in Nevada (56 percent), Idaho (30 percent), Oregon (12 percent), and Utah (2 percent). It makes up about 27,443 square miles. MLRA 25 is characteristically cooler and wetter than the neighboring MLRAs of the Great Basin. The western boundary is marked by a gradual transition to the lower and warmer basins of MLRA 24. The boundary to the south-southeast, with MLRA 28B, is marked by gradual changes in geology marked by an increased dominance of singleleaf pinyon and Utah juniper and a reduced presence of Idaho fescue. The boundary to the north, with MLRA 11, is a rapid transition from the lava plateau topography to the lower elevation Snake River Plain.

Physiography:

All of this area lies within the Intermontane Plateaus. The southern half is in the Great Basin section of the Basin and Range province. This part of the MLRA is characterized by isolated, uplifted fault-block mountain ranges separated by narrow, aggraded desert plains. This geologically older terrain has been dissected by numerous streams draining to the Humboldt River.

The northern half of the area lies within the Columbia Plateaus province. This part of the MLRA forms the southern boundary of the extensive Columbia Plateau basalt flows. Most of the northern half is in the Payette section, but the northeast corner is in the Snake River Plain section. Deep, narrow canyons draining into the Snake River have been incised into this broad basalt plain. Elevation ranges from 3,000 to 7,550 feet on rolling plateaus and in gently sloping basins. It is more than 9,840 feet on some steep mountains. The Humboldt River crosses the southern half of this area

Geology:

The dominant rock types in this MLRA are volcanic. They include andesite, basalt, tuff, and rhyolite. In the north and west parts of the area, Cretaceous granitic rocks are exposed among Miocene volcanic rocks in mountains. A Mesozoic igneous and metamorphic rock complex dominates the south and east parts of the area. Upper and Lower Paleozoic calcareous sediments, including oceanic deposits, are exposed with limited extent in the mountains. Alluvial fan and basin fill sediments occur in the valleys.

Climate:

The average annual precipitation in most of this area is typically 11 to 22 inches. It increases to as much as 49 inches at the higher elevations. Rainfall occurs in spring and sporadically in summer. Precipitation occurs mainly as snow in winter. The precipitation is distributed fairly evenly throughout fall, winter, and spring. The amount of precipitation is lowest from midsummer to early autumn. The average annual temperature is 33 to 51 degrees F. The freeze-free period averages 130 days and ranges from 65 to 190 days, decreasing in length with elevation. It is typically less than 70 days in the mountains.

Water:

The supply of water from precipitation and streamflow is small and unreliable, except along the Owyhee, Bruneau, and Humboldt Rivers. Streamflow depends largely on accumulated snow in the mountains. Surface water from mountain runoff is generally of excellent quality and suitable for all uses. The basin fill sediments in the narrow alluvial valleys between the mountain ranges provide some ground water for irrigation. The alluvial deposits along the large streams have the most ground water. Based on measurements of water quality in similar deposits in

adjacent areas, the basin fill deposits probably contain moderately hard water. The water is suitable for almost all uses. The carbonate rocks in this area are considered aquifers, but they are little used. Springs are common along the edges of the limestone outcrops.

Soils:

The dominant soil orders in this MLRA are Aridisols and Mollisols. The soils in the area dominantly have a mesic or frigid temperature regime and an aridic, aridic bordering on xeric, or xeric moisture regime. Soils with aquic moisture regimes are limited to drainage or spring areas, where moisture originates or runs on and through. These soils are of a very limited extent throughout the MLRA. They generally are well drained, clayey or loamy, and shallow or moderately deep. Most of the soils formed in mixed parent material. Volcanic ash and loess mantle the landscape. Surface soil textures are loam and silt loam with ashy texture modifiers in some areas. Argillic horizons occur on the more stable landforms. They are exposed nearer the soil surface on convex landforms, where ash and loess deposits are more likely to erode. Soils that formed in carbonatic parent material in areas that receive less than 12 inches of precipitation are characterized by calcic horizons throughout the profile, while soils in areas that receive more than 12 inches of precipitation do not have calcic horizons in the upper part of the profile. Soils that formed on stable landforms at the lower elevations are dominated by ochric horizons. Soils that formed at the middle and upper elevations are characterized by mollic epipedons. Soils in drainage areas at all elevations that receive moisture running on or through them are characterized by thicker mollic epipedons.

Biological Resources:

This MLRA supports shrub-grass vegetation. Lower elevations are characterized by Wyoming big sagebrush associated with bluebunch wheatgrass, western wheatgrass, and Thurber's needlegrass. Other important plants include bluegrass, squirreltail, penstemon, phlox, milkvetch, lupine, Indian paintbrush, aster, and rabbitbrush. Black sagebrush occurs but is less extensive. Singleleaf pinyon and Utah juniper occur in limited areas. With increasing elevation and precipitation, vast areas characterized by mountain big sagebrush or low sagebrush/early sagebrush in association with Idaho fescue, bluebunch wheatgrass, needlegrasses, and bluegrass become common. Snowberry, curl-leaf mountain mahogany, ceanothus, and juniper also occur. Mountains at the highest elevations support whitebark pine, Douglas-fir, limber pine, Engelmann spruce, subalpine fir, aspen, and curl-leaf mountain mahogany.

Major wildlife species include mule deer, bighorn sheep, pronghorn, mountain lion, coyote, bobcat, badger, river otter, mink, weasel, golden eagle, red-tailed hawk, ferruginous hawk, Swainson's hawk, northern harrier, prairie falcon, kestrel, great horned owl, short-eared owl, long-eared owl, burrowing owl, pheasant, sage grouse, chukar, gray partridge, and California quail. Reptiles and amphibians include western racer, gopher snake, western rattlesnake, side-blotched lizard, western toad, and spotted frog. Fish species include bull, red band, and rainbow trout.

Ecological site concept

This forest site is on mountain canyon bottoms and at the mouths of mountain canyon drainages along axial-stream floodplains. Slopes range from 0 to 4 percent. Elevations are 5300 to 7000 feet. The average growing season is 90 to 110 days.

The soils associated with this site are very deep, poorly drained, and have moderate permeability. The soils are formed in alluvium derived from mixed rocks. These soils are frequently flooded and have a seasonal water table at depths between 9 and 40 inches (22 to 100 cm). The soil profile generally is extremely gravelly or extremely cobbly between 10 and 20 inches (25 and 50 cm) below the soil surface and rock fragments extend through the remainder of the soil profile.

The reference plant community is dominated by narrowleaf cottonwood. Narrowleaf cottonwood is the principal understory tree. Willow, Wood's rose and currant are the principal understory shrubs. Bluegrass, sedges and rhizomatous wheatgrasses are the most prevalent understory grasses. Clover, yarrow, geranium and wildiris are common understory forbs. Overstory tree canopy composition is typically 100 percent narrowleaf cottonwood. Quaking aspen often becomes important in the overstory at the upper elevational range of this site. An overstory canopy of 20 to 35 percent is assumed to be representative of tree dominance on this site in the pristine environment.

This site used to be named: POAN3/SALIX/POA-CAREX

Associated sites

R025XY005NV	WET MEADOW Wet Meadow occurs on stream terraces, drainageways and floodplains and floods for brief durations in March, April, May and June. Productivity ranges from 1000 to 3000 lbs/yr. DECE-PONE3-PHAL2 dominated site.
R025XY001NV	MOIST FLOODPLAIN Moist Floodplain productivity ranges from 1000 to 3000 lbs/yr. LETR5 codominant grass.
R025XY003NV	LOAMY BOTTOM 8-14 P.Z. Loamy Bottom typically has a particle size control section of fine-loamy, rarely floods and for very brief intervals. Productivity ranges from 2000 to 4500 lbs/yr. ARTRV dominant shrub.
R025XY004OR	DRY MEADOW Dry Floodplain frequently floods for brief durations in March, April, May and June. Productivity ranges from 800 to 2000 lbs/yr. DISP and SAVE4 commonly occur on site.

Similar sites

R025XY001NV	MOIST FLOODPLAIN Moist Floodplain productivity ranges from 1000 to 3000 lbs/yr. LETR5 codominant grass.
-------------	---

Table 1. Dominant plant species

Tree	(1) <i>Populus angustifolia</i>
Shrub	(1) <i>Salix</i> (2) <i>Ribes</i>
Herbaceous	(1) <i>Poa</i> (2) <i>Carex</i>

Physiographic features

This forestland site is on mountain canyon floodplains and at the mouths of mountain canyon drainages along axial-streams and floodplains. Slopes range from 0 to 4 percent. Elevations are 5300 to 6400 feet.

Table 2. Representative physiographic features

Landforms	(1) Mountain valleys or canyons > Drainageway (2) Mountain valleys or canyons > Flood plain (3) Axial stream
Runoff class	Medium to high
Flooding duration	Brief (2 to 7 days)
Flooding frequency	Frequent
Elevation	1,615–1,951 m
Slope	0–4%
Water table depth	23–102 cm
Aspect	W, NW, N, NE, E, SE, S, SW

Table 3. Representative physiographic features (actual ranges)

Runoff class	Medium to high
Flooding duration	Not specified
Flooding frequency	Not specified
Elevation	Not specified
Slope	Not specified
Water table depth	Not specified

Climatic features

The climate associated with this site is semiarid, characterized by cold, moist winters and warm, dry summers. Mean annual air temperature is about 45 to 50 degrees F. The average growing season is 90 to 110 days.

Mean annual precipitation across the range of this ecological site is 16 inches.

Monthly mean precipitation: January 1.22"; February 0.92"; March 1.17"; April 1.20"; May 1.54"; June 1.11"; July 0.44"; August 0.45"; September 0.73"; October 0.86"; November 1.26"; December 1.29".

*The above data is averaged from the Deeth and Tuscarora WRCC climate stations, the Western Region Climate Center Database and the NASIS database.

Table 4. Representative climatic features

Frost-free period (characteristic range)	50-90 days
Freeze-free period (characteristic range)	70-120 days
Precipitation total (characteristic range)	356-457 mm
Frost-free period (actual range)	50-90 days
Freeze-free period (actual range)	70-120 days
Precipitation total (actual range)	254-508 mm
Frost-free period (average)	70 days
Freeze-free period (average)	87 days
Precipitation total (average)	406 mm

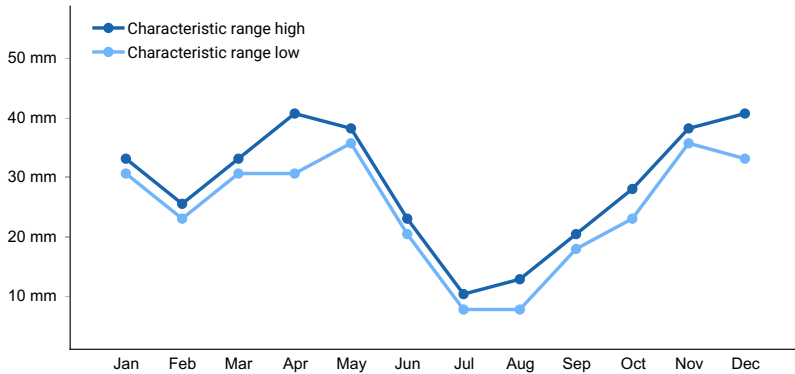

Figure 1. Monthly precipitation range

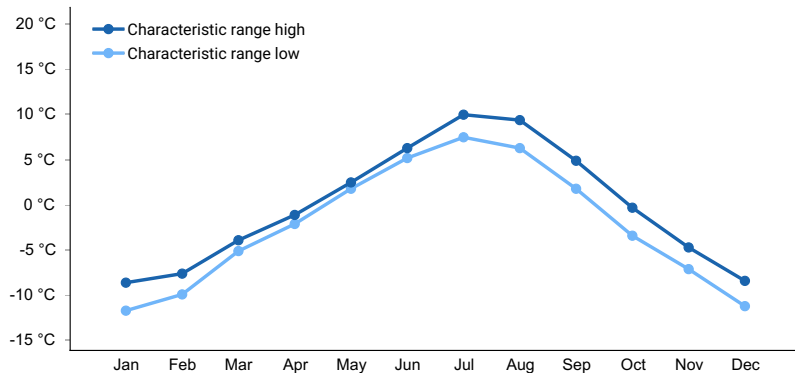

Figure 2. Monthly minimum temperature range

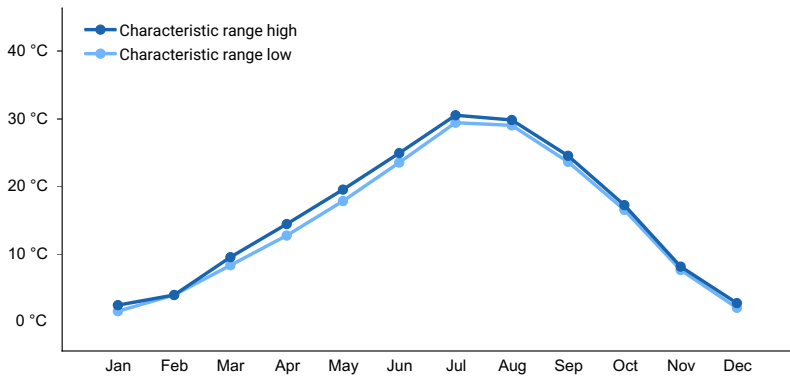

Figure 3. Monthly maximum temperature range

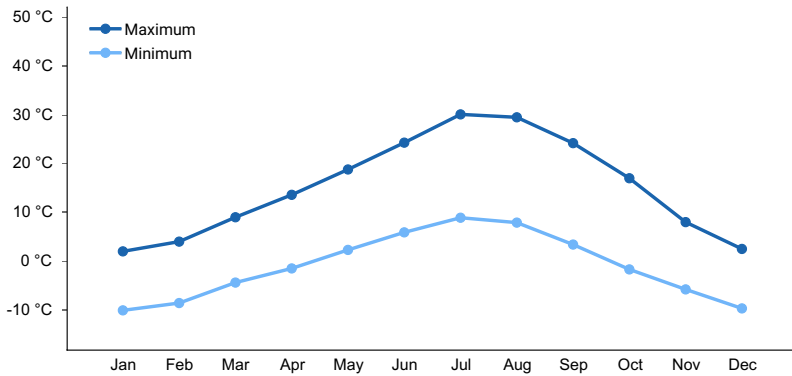

Figure 4. Monthly average minimum and maximum temperature

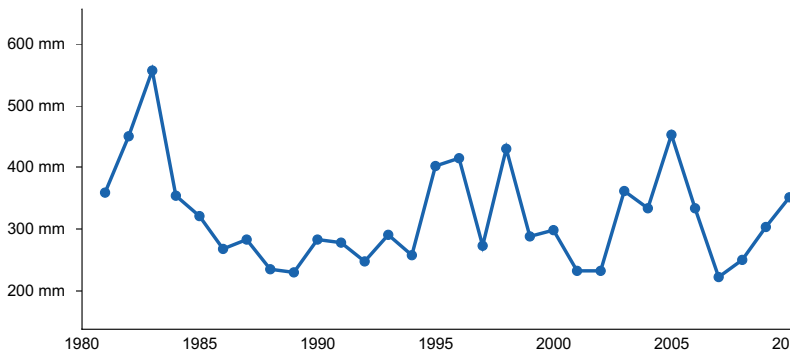

Figure 5. Annual precipitation pattern

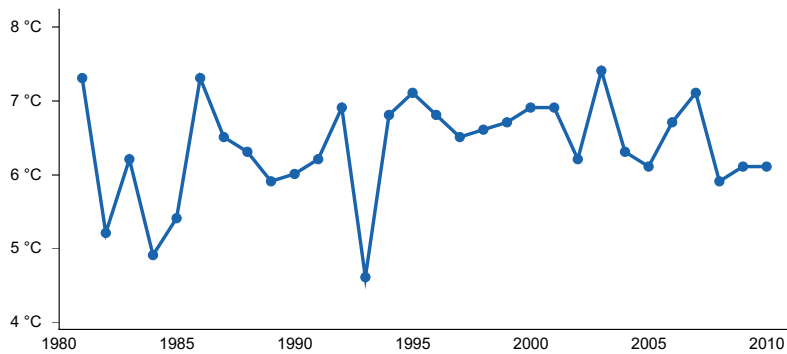

Figure 6. Annual average temperature pattern

Climate stations used

- (1) DEETH [USC00262189], Deeth, NV
- (2) TUSCARORA [USC00268346], Tuscarora, NV

Influencing water features

This site is associated with perennial mountain streams.

Soil features

The soils associated with this site are very deep, poorly drained, and have moderate permeability. The soils are formed in alluvium derived from mixed rocks, glaciomarine deposits derived from metamorphic rocks, loess and volcanic ash. These soils are frequently flooded and have a seasonal water table at depths between 9 and 40 inches (22 to 100 cm). The soil profile is typically extremely gravelly or extremely cobbly between 10 and 20 inches (25 and 50 cm) below the soil surface. Rock fragments extend through the remainder of the soil profile. Surface runoff class is medium. The soils are susceptible to gully formation which intercepts natural overflow patterns resulting in site degradation.

The soil series correlated to this site are Hourland and Alburz Variant.

Table 5. Representative soil features

Parent material	(1) Alluvium (2) Loess (3) Volcanic ash (4) Glaciomarine deposits–metavolcanics
Surface texture	(1) Loam (2) Very gravelly fine sandy loam
Family particle size	(1) Sandy-skeletal
Drainage class	Poorly drained
Permeability class	Moderate
Depth to restrictive layer	213 cm
Soil depth	183–213 cm
Surface fragment cover <=3"	0–15%
Surface fragment cover >3"	0–7%
Available water capacity (0-101.6cm)	3.05–9.65 cm
Calcium carbonate equivalent (0-101.6cm)	0%
Electrical conductivity (0-101.6cm)	0–2 mmhos/cm
Sodium adsorption ratio (0-101.6cm)	0
Soil reaction (1:1 water) (0-101.6cm)	6.6–8.4
Subsurface fragment volume <=3" (Depth not specified)	35–85%
Subsurface fragment volume >3" (Depth not specified)	5–25%

Ecological dynamics

The amount and nature of the understory vegetation in a forestland is highly responsive to the amount and duration of shade provided by the overstory canopy. Significant changes in kinds and abundance of plants occur as the canopy changes, often regardless of grazing use. Some changes occur slowly and gradually as a result of normal changes in tree size and spacing. Other changes occur dramatically and quickly, following intensive woodland harvest, thinning, or fire.

Fire Ecology:

Fire in riparian communities often only top-kills plants. Riparian species have deep buried rhizomes which usually survive all but the most severe fires. The mean fire return interval is typically less than 35 years. Fire will partially or completely kill narrowleaf cottonwood depending upon severity. Sandberg bluegrass is generally unharmed by fire. It produces little litter, and its small bunch size and sparse litter reduces the amount of heat transferred to perennating buds in the soil. Its rapid maturation in the spring also reduces fire damage, since it is dormant when most fires occur.

State and transition model

Ecosystem states

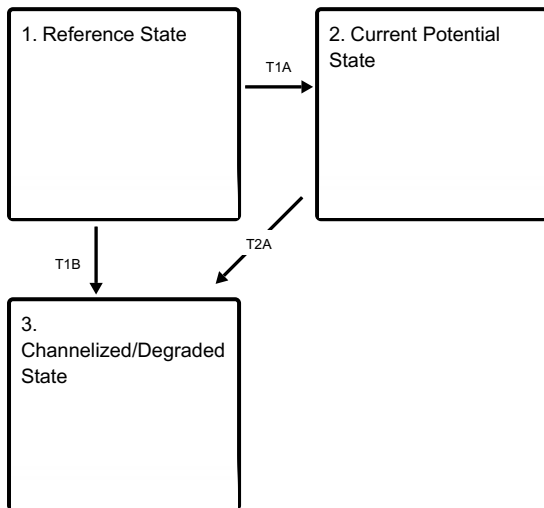

State 1 submodel, plant communities

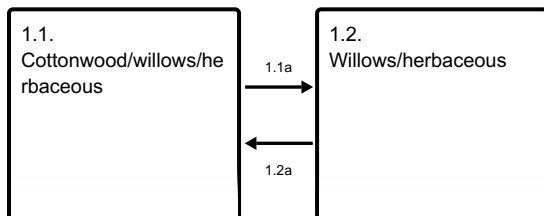

State 2 submodel, plant communities

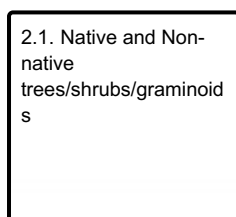

State 3 submodel, plant communities

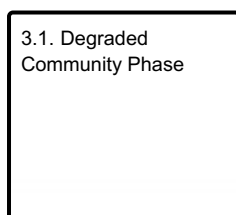

State 1 Reference State

The Reference State concept has two main community phases influenced by time since disturbance (flooding, fire, etc.). Cottonwood seeds will be left behind after a seasonal flood event. The cottonwood seedlings will germinate if the soil conditions are right (moist and bare). These seedlings, if left undisturbed, will mature to trees. Understory

plants, like rhizomatous willow and graminoids are less influenced by seasonal flooding and may remain intact after seasonal flooding. Extreme flooding or fire may remove the tree overstory and the understory, allowing the graminoids and willows to dominate the site until the conditions are appropriate for cottonwood establishment.

Community 1.1 Cottonwood/willows/herbaceous

The reference plant community is dominated by narrowleaf cottonwood. Narrowleaf cottonwood is the principal understory tree. Willow, Wood's rose and currant are the principal understory shrubs. Bluegrass, sedges and rhizomatous wheatgrasses are the most prevalent understory grasses. Clover, yarrow, geranium and wildiris are common understory forbs. Overstory tree canopy composition is typically 100 percent narrowleaf cottonwood. Quaking aspen often becomes important in the overstory at the upper elevational range of this site. An overstory canopy of 20 to 35 percent is assumed to be representative of tree dominance on this site in the pristine environment.

Forest overstory. MATURE FORESTLAND: The visual aspect and vegetal structure are dominated by cottonwood that have reached or are near maximal heights for the site. Tree canopy cover ranges from 20 to 35 percent. Understory vegetation is strongly influenced by tree competition, overstory shading, duff accumulation, etc. Few seedlings and/or saplings of cottonwood occur in the understory.

Forest understory. Understory vegetative composition is about 45 percent grasses and grass-like plants, 15 percent forbs and 40 percent shrubs and young trees when the average overstory canopy is medium (20 to 35 percent). Average understory production ranges from 1000 to 2500 pounds per acre with a medium canopy cover. Understory production includes the total annual production of all species within 4½ feet of the ground surface.

Table 6. Annual production by plant type

Plant Type	Low (Kg/Hectare)	Representative Value (Kg/Hectare)	High (Kg/Hectare)
Grass/Grasslike	504	1009	1261
Shrub/Vine	448	897	1121
Tree	112	224	280
Forb	56	112	140
Total	1120	2242	2802

Community 1.2 Willows/herbaceous

Community Phase 1.2 occurs after a disturbance that removed the tree canopy. This can occur after a fire or large flood.

Pathway 1.1a Community 1.1 to 1.2

Flooding, fire, or other disturbance that removes the tree canopy.

Pathway 1.2a Community 1.2 to 1.1

Sufficient time to allow the cottonwood trees to again establish on the site.

State 2 Current Potential State

The Current Potential State occurs after non-native plant species introduction. The species can range from trees,

shrubs, to herbaceous. Russian olive, tamarisk, Kentucky bluegrass, and thistles are common non-native plants.

Community 2.1

Native and Non-native trees/shrubs/graminoids

Non-native trees, like Russian olive are present and may dominate the tree canopy. Tamarisk may also occur and take the place of native willows. Kentucky bluegrass is effective at invading wet to semiwet sites and may dominate the understory.

State 3

Channelized/Degraded State

The Channelized/Degraded state is characterized by a adjacent stream that has been channelized. Most seasonal floodwaters remain the in channel and do not inundate the flood plain. This reduces cottonwood recruitment and may reduce soil moisture on the site allowing species that are more tolerant to dry conditions to establish.

Community 3.1

Degraded Community Phase

Plant Community Phase 3.1 may look like a drier ecological site with sagebrush or rabbitbrush. This phase may also be converted to a agricultural field or urban development.

Transition T1A

State 1 to 2

Introduction of non-native species.

Transition T1B

State 1 to 3

Channelization of adjacent stream channel. Reduced soil moisture and altered hydrology of the site. Urbanization and agriculture uses may be present.

Transition T2A

State 2 to 3

Reduced soil moisture and altered hydrology of the site. Urbanization and agriculture uses may be present.

Additional community tables

Table 7. Community 1.1 plant community composition

Group	Common Name	Symbol	Scientific Name	Annual Production (Kg/Hectare)	Foliar Cover (%)
Grass/Grasslike					
1	Primary Perennial Grasses			673–1211	
	sedge	CAREX	<i>Carex</i>	112–202	–
	thickspike wheatgrass	ELLA3	<i>Elymus lanceolatus</i>	112–202	–
	slender wheatgrass	ELTR7	<i>Elymus trachycaulus</i>	112–202	–
	rush	JUNCU	<i>Juncus</i>	112–202	–
	western wheatgrass	PASM	<i>Pascopyrum smithii</i>	112–202	–
	bluegrass	POA	<i>Poa</i>	112–202	–
Forb					
2	Perennial			67–135	
	thickspike wheatgrass	ELLA3	<i>Elymus lanceolatus</i>	22–112	–
	slender wheatgrass	ELTR7	<i>Elymus trachycaulus</i>	22–112	–
	western wheatgrass	PASM	<i>Pascopyrum smithii</i>	22–112	–
	yarrow	ACHIL	<i>Achillea</i>	11–22	–
	columbine	AQUIL	<i>Aquilegia</i>	11–22	–
	feathery false lily of the valley	MARA7	<i>Maianthemum racemosum</i>	11–22	–
	ragwort	SENEC	<i>Senecio</i>	11–22	–
	Fendler's meadow-rue	THFE	<i>Thalictrum fendleri</i>	11–22	–
	clover	TRIFO	<i>Trifolium</i>	11–22	–
Shrub/Vine					
3	Primary Shrubs			381–829	
	redosier dogwood	COSE16	<i>Cornus sericea</i>	112–202	–
	black chokecherry	PRVIM	<i>Prunus virginiana</i> var. <i>melanocarpa</i>	112–202	–
	currant	RIBES	<i>Ribes</i>	112–202	–
	Woods' rose	ROWO	<i>Rosa woodsii</i>	112–202	–
	willow	SALIX	<i>Salix</i>	112–202	–
Tree					
4	Deciduous			123–224	
	narrowleaf cottonwood	POAN3	<i>Populus angustifolia</i>	112–202	–
	quaking aspen	POTR5	<i>Populus tremuloides</i>	11–22	–
	yarrow	ACHIL	<i>Achillea</i>	1–22	–
	columbine	AQUIL	<i>Aquilegia</i>	1–22	–
	Fendler's meadow-rue	THFE	<i>Thalictrum fendleri</i>	1–22	–
5	Evergreen			11–22	
	Rocky Mountain juniper	JUSC2	<i>Juniperus scopulorum</i>	11–22	–

Animal community

Livestock Interpretations:

This site is suited to cattle and sheep grazing during the early summer and fall. Livestock will often concentrate on this site taking advantage of the shade and shelter offered by the tree overstory. Harvesting trees under a sound management program for fuelwood or other products can open up the tree canopy to allow increased production of

understory species desirable for grazing.

Stocking rates vary with such factors as kind and class of grazing animal, season of use and fluctuations in climate. Actual use records for individual sites, a determination of the degree to which the sites have been grazed, and an evaluation of trend in site condition offer the most reliable basis for developing initial stocking rates.

Wildlife Interpretations:

This site provides valuable habitat to mule deer during the summer. It furnishes ideal habitat for a variety of tree and ground nesting birds. Beaver can be sustained by the trees on this site. It is also used by various small mammals and reptiles and their associate predators natural to the area.

Hydrological functions

A well stocked narrowleaf cottonwood stand provides excellent watershed protection. A mixture of herbaceous and woody root systems penetrate and anchor the soil. Erosion producing overland flow is almost non-existent. Hydrologic soil group is D. The hydrologic cover condition of this site is good in a representative stand. The average runoff curve is about 80 for group D soils. Runoff is very high. Permeability is moderate.

Recreational uses

Aesthetic value is derived from the rich hues and textures of the trees, particularly in the fall. The diverse floral and faunal composition and the colorful flowering of wildflowers during the summer enhance the beauty of this site. The site offers rewarding opportunities to photographers and for nature study. It has high value for hunting, camping, picnicking and family wood gathering.

Wood products

This site is of medium quality for tree production. Site index ranges from about 81 to 92 (Baker & Broadfoot, 1977).

Productivity class: 6

CMAI*: 80 to 108 ft³/ac/yr

5.6 to 7.5 m³/ha/yr

*CMAI: is the culmination of mean annual increment or highest average growth rate of the stand in the units specified.

Fuelwood Production: About 8 to 10 cords per acre. Firewood is commonly measured by cords, or a stacked unit equivalent to 128 cubic feet. Solid wood volume in a cord varies but usually ranges from 65 to 90 cubic feet. Assuming an average of 75 cubic feet of solid wood volume per cord, there are about 15 million British Thermal Units (BTUs) heat value in a cord of narrowleaf cottonwood wood.

Saw timber: 200 to 300 board-feet per acre.

MANAGEMENT GUIDES AND INTERPRETATIONS

1. LIMITATIONS AND CONSIDERATIONS

- a. Potential for sheet erosion is low.
- b. Moderate to severe equipment limitations on wet soils.
- c. Proper spacing is the key to a well managed, multiple use and multi-product narrowleaf cottonwood woodland.

2. ESSENTIAL REQUIREMENTS

- a. Adequately protect from high intensity wildfire.
- b. Protect soils from accelerated erosion.
- c. Apply proper grazing management.

3. SILVICULTURAL PRACTICES

- a. Harvest cut selectively or in small patches (size dependent upon site conditions) to enhance forage production.
 - 1) Thinning and improvement cutting - Removal of poorly formed, diseased and low vigor trees for fuelwood.

- 2) Harvest cutting - Selectively harvest surplus trees to achieve desired spacing. Harvest stands in small blocks of 1/5 to 1/2 acre with slash left in place to shelter emerging seedlings from browsing.
 - 3) Selective Tree Removal - Remove selected trees on suitable sites to enhance forage production and manage site reproduction.
 - 4) Spacing Guide - A spacing of about 15 X 15 feet at stand maturity is considered desirable for multiple use management.
- c. Pest control - Use necessary and approved control for specific pests and diseases.
- d. Fire hazard - Fire is rarely a problem in narrowleaf cottonwood stands. However, even a light fire may kill narrowleaf cottonwood seedlings, saplings, and mature trees.

Other information

Narrowleaf cottonwood has been used for lumber, fence posts, and fuelwood. This tree has a considerable potential for increased utilization. It makes excellent pulp. Some of this wood is used for the production of excelsior, door corestock and boxwood. An undesirable characteristic of narrowleaf cottonwood is the heavy drain on soil moisture.

Table 8. Representative site productivity

Common Name	Symbol	Site Index Low	Site Index High	CMAI Low	CMAI High	Age Of CMAI	Site Index Curve Code	Site Index Curve Basis	Citation
narrowleaf cottonwood	POAN3	81	92	80	108	—	—	—	

Inventory data references

Data for this site was retrieved from the NASIS database.

Type locality

Location 1: Elko County, NV	
Township/Range/Section	T31N R56E S13
General legal description	Along the south fork of the Humboldt River near Lee, Elko County, Nevada.

Other references

Airola, D. A. 1980. Northeast Interior Zone: Vol. III - Birds & Vol. IV - Mammals. U.S. Gov. Printing Off.: 1980-690-082/26.

Baker, J. B., Broadfoot, W. M. 1977. Site Evaluation for Eight Important Southern Hardwoods. USDA-FS, GTR 50-14.

Eyre, F.H. (editor). 1980. Forest Cover Types of the United States and Canada. Society of American Foresters, Washington, D.C.

Fire Effects Information System [Online]. <http://www.fs.fed.us/feis>

Houghton, J.G., C.M. Sakamoto, and R.O. Gifford. 1975. Nevada's Weather and Climate, Special Publication 2. Nevada Bureau of Mines and Geology, Mackay School of Mines, University of Nevada, Reno, NV.

National Oceanic and Atmospheric Administration. 2004. The North American Monsoon. Reports to the Nation. National Weather Service, Climate Prediction Center. Available online: <http://www.weather.gov/>

Contributors

RK

Approval

Kendra Moseley, 4/24/2024

Rangeland health reference sheet

Interpreting Indicators of Rangeland Health is a qualitative assessment protocol used to determine ecosystem condition based on benchmark characteristics described in the Reference Sheet. A suite of 17 (or more) indicators are typically considered in an assessment. The ecological site(s) representative of an assessment location must be known prior to applying the protocol and must be verified based on soils and climate. Current plant community cannot be used to identify the ecological site.

Author(s)/participant(s)	
Contact for lead author	
Date	05/19/2024
Approved by	Kendra Moseley
Approval date	
Composition (Indicators 10 and 12) based on	Annual Production

Indicators

1. **Number and extent of rills:**

2. **Presence of water flow patterns:**

3. **Number and height of erosional pedestals or terracettes:**

4. **Bare ground from Ecological Site Description or other studies (rock, litter, lichen, moss, plant canopy are not bare ground):**

5. **Number of gullies and erosion associated with gullies:**

6. **Extent of wind scoured, blowouts and/or depositional areas:**

7. **Amount of litter movement (describe size and distance expected to travel):**

8. **Soil surface (top few mm) resistance to erosion (stability values are averages - most sites will show a range of values):**

9. **Soil surface structure and SOM content (include type of structure and A-horizon color and thickness):**

10. **Effect of community phase composition (relative proportion of different functional groups) and spatial**

distribution on infiltration and runoff:

11. **Presence and thickness of compaction layer (usually none; describe soil profile features which may be mistaken for compaction on this site):**
-

12. **Functional/Structural Groups (list in order of descending dominance by above-ground annual-production or live foliar cover using symbols: >>, >, = to indicate much greater than, greater than, and equal to):**

Dominant:

Sub-dominant:

Other:

Additional:

13. **Amount of plant mortality and decadence (include which functional groups are expected to show mortality or decadence):**
-

14. **Average percent litter cover (%) and depth (in):**
-

15. **Expected annual annual-production (this is TOTAL above-ground annual-production, not just forage annual-production):**
-

16. **Potential invasive (including noxious) species (native and non-native). List species which BOTH characterize degraded states and have the potential to become a dominant or co-dominant species on the ecological site if their future establishment and growth is not actively controlled by management interventions. Species that become dominant for only one to several years (e.g., short-term response to drought or wildfire) are not invasive plants. Note that unlike other indicators, we are describing what is NOT expected in the reference state for the ecological site:**
-

17. **Perennial plant reproductive capability:**
-