

Ecological site F025XY059NV Gravelly Juniper

Last updated: 4/24/2024
Accessed: 05/19/2024

General information

Provisional. A provisional ecological site description has undergone quality control and quality assurance review. It contains a working state and transition model and enough information to identify the ecological site.

MLRA notes

Major Land Resource Area (MLRA): 025X—Owyhee High Plateau

MLRA Notes 25—Owyhee High Plateau

This area is in Nevada (56 percent), Idaho (30 percent), Oregon (12 percent), and Utah (2 percent). It makes up about 27,443 square miles. MLRA 25 is characteristically cooler and wetter than the neighboring MLRAs of the Great Basin. The western boundary is marked by a gradual transition to the lower and warmer basins of MLRA 24. The boundary to the south-southeast, with MLRA 28B, is marked by gradual changes in geology marked by an increased dominance of singleleaf pinyon and Utah juniper and a reduced presence of Idaho fescue. The boundary to the north, with MLRA 11, is a rapid transition from the lava plateau topography to the lower elevation Snake River Plain.

Physiography:

All of this area lies within the Intermontane Plateaus. The southern half is in the Great Basin section of the Basin and Range province. This part of the MLRA is characterized by isolated, uplifted fault-block mountain ranges separated by narrow, aggraded desert plains. This geologically older terrain has been dissected by numerous streams draining to the Humboldt River.

The northern half of the area lies within the Columbia Plateaus province. This part of the MLRA forms the southern boundary of the extensive Columbia Plateau basalt flows. Most of the northern half is in the Payette section, but the northeast corner is in the Snake River Plain section. Deep, narrow canyons draining into the Snake River have been incised into this broad basalt plain. Elevation ranges from 3,000 to 7,550 feet on rolling plateaus and in gently sloping basins. It is more than 9,840 feet on some steep mountains. The Humboldt River crosses the southern half of this area

Geology:

The dominant rock types in this MLRA are volcanic. They include andesite, basalt, tuff, and rhyolite. In the north and west parts of the area, Cretaceous granitic rocks are exposed among Miocene volcanic rocks in mountains. A Mesozoic igneous and metamorphic rock complex dominates the south and east parts of the area. Upper and Lower Paleozoic calcareous sediments, including oceanic deposits, are exposed with limited extent in the mountains. Alluvial fan and basin fill sediments occur in the valleys.

Climate:

The average annual precipitation in most of this area is typically 11 to 22 inches. It increases to as much as 49 inches at the higher elevations. Rainfall occurs in spring and sporadically in summer. Precipitation occurs mainly as snow in winter. The precipitation is distributed fairly evenly throughout fall, winter, and spring. The amount of precipitation is lowest from midsummer to early autumn. The average annual temperature is 33 to 51 degrees F. The freeze-free period averages 130 days and ranges from 65 to 190 days, decreasing in length with elevation. It is typically less than 70 days in the mountains.

Water:

The supply of water from precipitation and streamflow is small and unreliable, except along the Owyhee, Bruneau, and Humboldt Rivers. Streamflow depends largely on accumulated snow in the mountains. Surface water from mountain runoff is generally of excellent quality and suitable for all uses. The basin fill sediments in the narrow alluvial valleys between the mountain ranges provide some ground water for irrigation. The alluvial deposits along the large streams have the most ground water. Based on measurements of water quality in similar deposits in

adjacent areas, the basin fill deposits probably contain moderately hard water. The water is suitable for almost all uses. The carbonate rocks in this area are considered aquifers, but they are little used. Springs are common along the edges of the limestone outcrops.

Soils:

The dominant soil orders in this MLRA are Aridisols and Mollisols. The soils in the area dominantly have a mesic or frigid temperature regime and an aridic, aridic bordering on xeric, or xeric moisture regime. Soils with aquic moisture regimes are limited to drainage or spring areas, where moisture originates or runs on and through. These soils are of a very limited extent throughout the MLRA. They generally are well drained, clayey or loamy, and shallow or moderately deep. Most of the soils formed in mixed parent material. Volcanic ash and loess mantle the landscape. Surface soil textures are loam and silt loam with ashy texture modifiers in some areas. Argillic horizons occur on the more stable landforms. They are exposed nearer the soil surface on convex landforms, where ash and loess deposits are more likely to erode. Soils that formed in carbonatic parent material in areas that receive less than 12 inches of precipitation are characterized by calcic horizons throughout the profile, while soils in areas that receive more than 12 inches of precipitation do not have calcic horizons in the upper part of the profile. Soils that formed on stable landforms at the lower elevations are dominated by ochric horizons. Soils that formed at the middle and upper elevations are characterized by mollic epipedons. Soils in drainage areas at all elevations that receive moisture running on or through them are characterized by thicker mollic epipedons.

Biological Resources:

This MLRA supports shrub-grass vegetation. Lower elevations are characterized by Wyoming big sagebrush associated with bluebunch wheatgrass, western wheatgrass, and Thurber's needlegrass. Other important plants include bluegrass, squirreltail, penstemon, phlox, milkvetch, lupine, Indian paintbrush, aster, and rabbitbrush. Black sagebrush occurs but is less extensive. Singleleaf pinyon and Utah juniper occur in limited areas. With increasing elevation and precipitation, vast areas characterized by mountain big sagebrush or low sagebrush/early sagebrush in association with Idaho fescue, bluebunch wheatgrass, needlegrasses, and bluegrass become common. Snowberry, curl-leaf mountain mahogany, ceanothus, and juniper also occur. Mountains at the highest elevations support whitebark pine, Douglas-fir, limber pine, Engelmann spruce, subalpine fir, aspen, and curl-leaf mountain mahogany.

Major wildlife species include mule deer, bighorn sheep, pronghorn, mountain lion, coyote, bobcat, badger, river otter, mink, weasel, golden eagle, red-tailed hawk, ferruginous hawk, Swainson's hawk, northern harrier, prairie falcon, kestrel, great horned owl, short-eared owl, long-eared owl, burrowing owl, pheasant, sage grouse, chukar, gray partridge, and California quail. Reptiles and amphibians include western racer, gopher snake, western rattlesnake, side-blotched lizard, western toad, and spotted frog. Fish species include bull, red band, and rainbow trout.

Ecological site concept

This site occurs on dissected alluvial fan remnants, hills and lower mountain summits and side slopes on all aspects. Slopes range from 4 to over 75 percent, but are typically 15 to 50 percent. Elevations are 5000 to 7100 feet.

Soils associated with this forestland site are shallow to moderately deep with average depth to bedrock or hardpan ranging from 15 to about 35 inches. Some soils may have more than 35 percent rock fragments by volume distributed throughout their profile. These soils are neutral to strongly alkaline in reaction and may be calcareous.

The reference plant community is dominated by Utah juniper. Wyoming big sagebrush is the principal understory shrub. Bluebunch wheatgrass, Thurber's needlegrass, Indian ricegrass, and bluegrasses are the most prevalent understory grasses. Phlox and milkvetch are common understory forbs.

Overstory tree canopy composition is 100 percent Utah juniper. An overstory canopy cover of 20 to 35 percent is assumed to be representative of tree dominance on this site in the pristine environment.

This site used to be named: JUOS/ARTRW/PSSPS-ACTH7

Associated sites

R025XY019NV	LOAMY 8-10 P.Z. Loamy 8-10 dominant species are ARTRW/ACTH7-PSSPS. Site lacks JUOS.
-------------	---

R025XY014NV	LOAMY 10-12 P.Z. Loamy 10-12 dominant species are ARTR2/PSSPS-ACTH7. Site lacks JUOS.
R025XY003NV	LOAMY BOTTOM 8-14 P.Z. Loamy Bottom dominant species are ARTRT/LECI4. Site lacks JUOS.
R025XY027NV	LOAMY 12-14 P.Z. Loamy 12-14 dominant species are ARTRT/FEID. Site lacks JUOS.

Similar sites

F025XY060NV	Thin Surface Juniper Thin Surface Juniper is typically more shallow to bedrock.
-------------	---

Table 1. Dominant plant species

Tree	(1) <i>Juniperus osteosperma</i>
Shrub	(1) <i>Artemisia tridentata subsp. wyomingensis</i>
Herbaceous	(1) <i>Pseudoroegneria spicata subsp. spicata</i> (2) <i>Achnatherum thurberianum</i>

Physiographic features

The Gravelly Juniper site occurs on dissected alluvial fan remnants, hills and lower mountain summits and side slopes on all aspects. Slopes range from 4 to over 75 percent, but are typically 15 to 50 percent. Elevations are 5000 to 7100 feet.

Table 2. Representative physiographic features

Landforms	(1) Hill (2) Mountain (3) Fan remnant
Runoff class	High to very high
Flooding frequency	None
Ponding frequency	None
Elevation	1,524–2,164 m
Slope	4–50%
Water table depth	203 cm
Aspect	W, NW, N, NE, E, SE, S, SW

Table 3. Representative physiographic features (actual ranges)

Runoff class	Not specified
Flooding frequency	Not specified
Ponding frequency	Not specified
Elevation	Not specified
Slope	4–75%
Water table depth	Not specified

Climatic features

The climate associated with this site is semiarid, characterized by cold, moist winters and warm, dry summers. The average annual precipitation ranges from 10 to 12 inches. Mean annual air temperature is about 45 to 50 degrees F. The average growing season is 100 to 120 days.

Mean annual precipitation across the range in which this ES occurs is 11 inches.

Monthly mean precipitation: January 1.22"; February 0.92"; March 1.17"; April 1.20"; May 1.54"; June 1.11"; July 0.44"; August 0.45"; September 0.73"; October 0.86"; November 1.26"; December 1.29".

*The above data is averaged from the Death and Tuscarora WRCC climate stations and the NASIS database.

Table 4. Representative climatic features

Frost-free period (characteristic range)	90-120 days
Freeze-free period (characteristic range)	100-130 days
Precipitation total (characteristic range)	254-305 mm
Frost-free period (actual range)	90-120 days
Freeze-free period (actual range)	100-130 days
Precipitation total (actual range)	254-305 mm
Frost-free period (average)	100 days
Freeze-free period (average)	110 days
Precipitation total (average)	279 mm

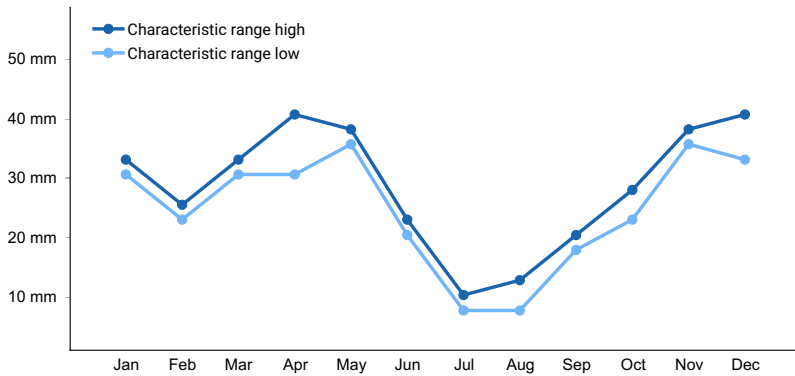

Figure 1. Monthly precipitation range

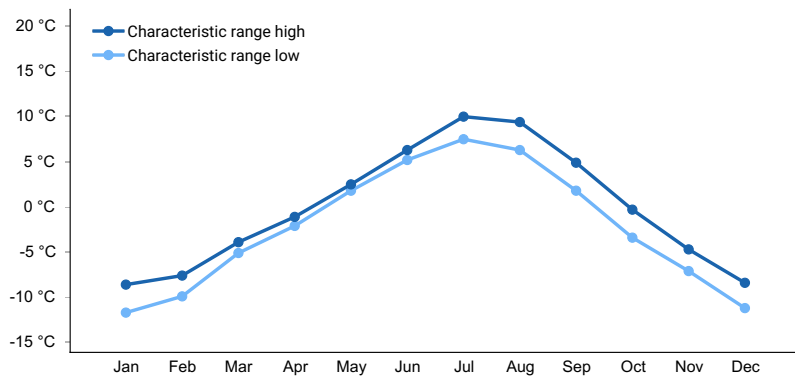

Figure 2. Monthly minimum temperature range

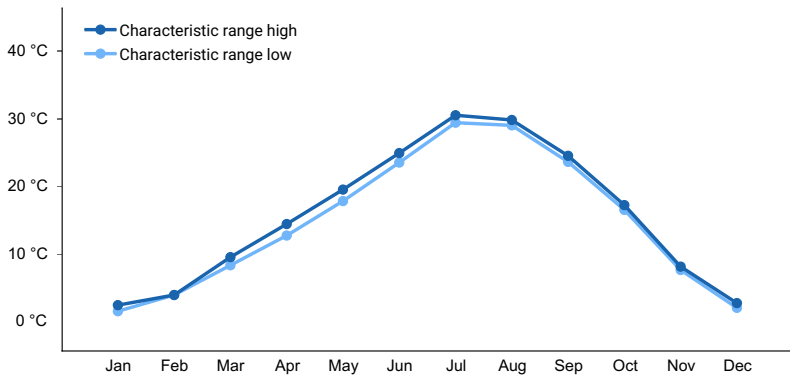

Figure 3. Monthly maximum temperature range

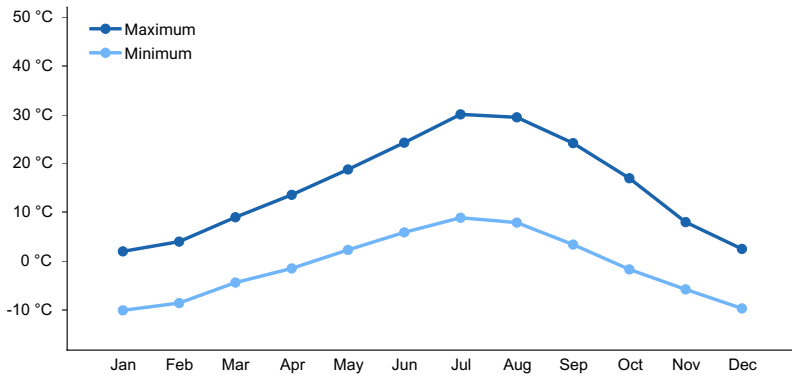

Figure 4. Monthly average minimum and maximum temperature

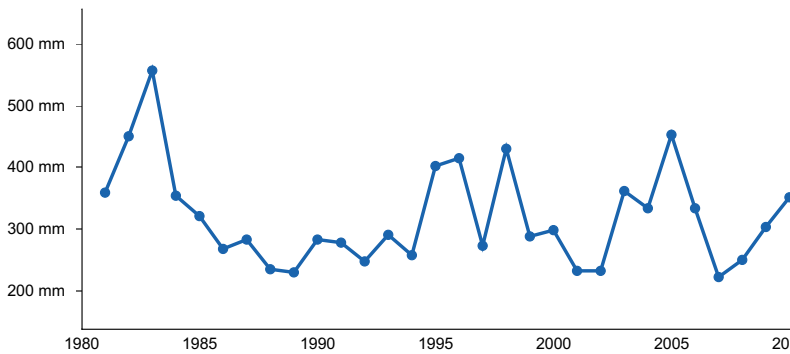

Figure 5. Annual precipitation pattern

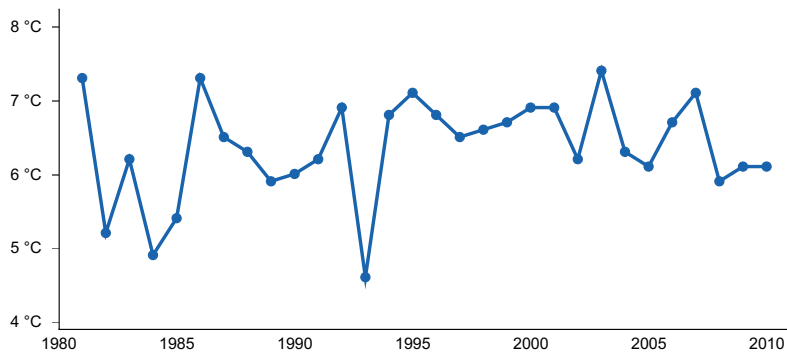

Figure 6. Annual average temperature pattern

Climate stations used

- (1) TUSCARORA [USC00268346], Tuscarora, NV
- (2) DEETH [USC00262189], Deeth, NV

Influencing water features

There are no influencing water features associated with this site.

Soil features

Soils associated with this forestland site are shallow to moderately deep with average depth to bedrock or hardpan ranging from 15 to about 35 inches (38 to 88 cm). Soils may have more than 35 percent rock fragments by volume distributed throughout their profile. Soils may have a high number of gravels, cobbles or stones on their surface that helps to reduce evaporation and conserve soil moisture.

A surface cover of rock fragments has a stabilizing effect on surface erosion conditions. Runoff is high to very high and potential for sheet and rill erosion is moderate to severe depending on slope. Available water capacity is very low to moderate.

These soils are neutral to strongly alkaline in reaction and may be calcareous.

The soil series correlated with this site include: Grina, Karpp, Perwick, Puett, Samor, and Soughe.

A representative soil series is Grina, classified as a loamy, mixed, superactive, calcareous, mesic, shallow Xeric Torriorthent. Grina series is a shallow, well-drained soil that formed in residuum and colluvium derived from soft sedimentary bedrock. Reaction is moderately alkaline and effervescence ranges from strongly to violently. Diagnostic features include an ochric epipedon from the soil surface to 7 inches (18 cm). Clay content in the particle-size control section averages 20 to 35 percent. Rock fragments average 0 to 15 percent.

Table 5. Representative soil features

Parent material	(1) Colluvium (2) Residuum (3) Alluvium
Surface texture	(1) Coarse sandy loam (2) Gravelly fine sandy loam (3) Silt loam (4) Gravelly silt loam (5) Very gravelly loam (6) Gravelly loam
Family particle size	(1) Loamy (2) Loamy-skeletal (3) Coarse-loamy (4) Fine-loamy
Drainage class	Moderately well drained to well drained
Permeability class	Moderately slow to moderately rapid
Depth to restrictive layer	38–89 cm
Soil depth	38–89 cm
Surface fragment cover ≤3"	15–35%
Surface fragment cover >3"	0–20%
Available water capacity (0-101.6cm)	2.54–14.73 cm
Calcium carbonate equivalent (0-101.6cm)	5–40%
Electrical conductivity (0-101.6cm)	0–4 mmhos/cm
Sodium adsorption ratio (0-101.6cm)	0–12

Soil reaction (1:1 water) (0-101.6cm)	6.6–9.6
Subsurface fragment volume <=3" (Depth not specified)	9–40%
Subsurface fragment volume >3" (Depth not specified)	2–18%

Table 6. Representative soil features (actual values)

Drainage class	Not specified
Permeability class	Not specified
Depth to restrictive layer	Not specified
Soil depth	Not specified
Surface fragment cover <=3"	5–40%
Surface fragment cover >3"	Not specified
Available water capacity (0-101.6cm)	Not specified
Calcium carbonate equivalent (0-101.6cm)	Not specified
Electrical conductivity (0-101.6cm)	Not specified
Sodium adsorption ratio (0-101.6cm)	Not specified
Soil reaction (1:1 water) (0-101.6cm)	Not specified
Subsurface fragment volume <=3" (Depth not specified)	Not specified
Subsurface fragment volume >3" (Depth not specified)	Not specified

Ecological dynamics

An ecological site is the product of all the environmental factors responsible for its development and has a set of key characteristics that influence a site's resilience to disturbance and resistance to invasives. Key characteristics include 1) climate (precipitation and temperature), 2) topography (aspect, slope, elevation, and landform), 3) hydrology (infiltration and runoff), 4) soils (depth, texture, structure, and organic matter), 5) plant communities (functional groups and productivity), and 6) natural disturbance regime (fire, herbivory, etc.) (Caudle et al. 2013). Biotic factors that influence resilience include site productivity, species composition and structure, and population regulation and regeneration (Chambers et al. 2013).

Pinyon- and juniper-dominated plant communities in the cold desert of the Intermountain West occupy over 18 million ha (44,600,000 acres) (Miller and Tausch 2001). In the mid- to late 1900's, the number of pinyon and juniper trees establishing per decade began to increase when compared to the previous several hundred years. This substantial increase in conifer establishment was attributed to a number of factors, the most important being 1) the cessation of the aboriginal burning (Tausch 1999), 2) a change in climate with rising temperatures (Heyerdahl et al. 2006), 3) the reduced frequency of fire likely driven by the introduction of domestic livestock, 4) a decrease in wildfire frequency along with improved wildfire suppression efforts, and 5) potentially increased CO₂ levels favoring woody plant establishment (Tausch 1999, Bunting 1994). Miller et al. (2008) found presettlement tree densities averaged 2 to 11 per acre in six woodlands studied across the Intermountain West. Current stand densities range from 80 to 358 trees per acre. In Utah, Nevada, and Oregon, trees established prior to 1860 account for only 2 percent or less of the total population of pinyon and juniper (Miller et al. 2008). The research strongly suggests that for over 200 years prior to settlement, woodlands in the Great Basin were relatively low density with limited rates of establishment (Miller et al. 2008, Miller and Tausch 2001) and that tree canopy cover of 10 to 20 percent may be

more representative of these sites in pristine condition. Some ecological sites are capable of supporting persistent woodlands, likely due to specific soils and climate resulting in infrequent stand replacement disturbance regimes.

Increases in juniper densities post-settlement were the result of both infill in mixed age tree communities and expansion into shrub-steppe communities. However, the proportion of old-growth can vary depending on disturbance regimes, soils and climate. In the Great Basin, old-growth trees have been found to typically grow on rocky shallow or sandy soils that support little understory vegetation to carry a fire (Holmes et al. 1986, Miller and Rose 1995, West et al. 1998).

Infilling by younger trees increases canopy cover, causing a decrease in understory perennial vegetation and an increase in bare ground. As juniper trees increase in density, so does their litter. Phenolic compounds of juniper scales can have an inhibitory effect on grass growth (Jameson 1970). Furthermore, infilling shifts level biomass from ground fuels to canopy fuels which has the potential to significantly impact fire behavior. The more tree-dominated juniper woodlands become, the less likely they are to burn under moderate conditions, resulting in infrequent high intensity fires (Gruell 1999, Miller et al. 2008). Additionally, as the understory vegetation declines in vigor and density with increased canopy, the seed and propagules of the understory plant community also decrease significantly. This increase in bare ground allows for the invasion of non-native annual species such as cheatgrass. With intensive wildfire, the potential for conversion to annual exotics is a serious threat (Tausch 1999, Miller et al. 2008).

Utah juniper is a long-lived tree species with wide ecological amplitudes (Tausch et al. 1981, Weisberg and Dongwook 2012, West et al. 1998). Maximum ages of pinyon and juniper exceed 1000 years and stands with maximum age classes are only found on steep rocky slopes with no evidence of fire (West et al. 1975). Pinyon is slow-growing and very intolerant to shade with the exception of young plants, usually first year seedlings (Tueller and Clark 1975). Singleleaf pinyon seedling establishment is episodic. Population age structure is affected by long-term drought, which reduces seedling and sapling recruitment more than other age classes. The ecotones between singleleaf pinyon woodlands and adjacent shrublands and grasslands provide favorable microhabitats for singleleaf pinyon seedling establishment since they are active zones for seed dispersal, nurse plants are available, and singleleaf pinyon seedlings are only affected by competition from grass and other herbaceous vegetation for a couple of years.

Specific successional pathways after disturbance in pinyon-juniper stands are dependent on a number of variables, such as plant species present at the time of disturbance and their individual responses to disturbance, past management, type and size of disturbance, available seed sources in the soil or adjacent areas, and site and climatic conditions throughout the successional process.

Utah juniper can be killed by a fungus called Juniper Pocket Rot (*Pyrofomes demidoffi*), also known as white truck rot (Eddleman et al. 1994 and Durham 2014). Pocket rot enters the tree through any wound or opening that exposes the heartwood. In an advanced stage, this fungus can cause high mortality (Durham 2014). Dwarf mistletoe (*Phorandendron* spp.), a parasitic plant, may also affect Utah juniper and without treatment or pruning, may kill the tree 10-15 years after infection. Seedlings and saplings are most susceptible to the parasite (Christopherson 2014). Other diseases affecting juniper are: witches'-broom (*Gymnosporangium* sp.) that may girdle and kill branches; leaf rust (*Gymnosporangium* sp.) on leaves and young branches; and juniper blight (*Phomopsis* sp.). Flat-head borers (*Chrysobothris* sp.) attack the wood; long-horned beetles (*Methia juniper*, *Styloxus bicolor*) girdle limbs and twigs; and round-head borers (*Callidium* spp.) attack twigs and limbs (Tueller and Clark 1975).

Juniper growth is dependent mostly upon soil moisture stored from winter precipitation, mainly snow. Much of the summer precipitation is ineffective, being lost in runoff after summer convection storms or by evaporation and interception (Tueller and Clark 1975). Pinyon and juniper are highly resistant to drought which is common in the Great Basin. Tap roots of pinyon and juniper have a relatively rapid rate of root elongation and are thus able to persist until precipitation conditions are more favorable (Emerson 1932).

Wyoming big sagebrush, the dominant shrub on this site, is the most drought tolerant of the big sagebrushes and is generally long-lived, deeming it unnecessary for new individuals to recruit every year for perpetuation of the stand. Infrequent large recruitment events and simultaneous low, continuous recruitment is the foundation of population maintenance (Noy-Meir 1973). Survival of the seedlings is dependent on adequate moisture conditions.

The perennial bunchgrasses that are co-dominant with the shrubs include Indian ricegrass, bluebunch wheatgrass, Thurber's needlegrass, and Sandberg bluegrass. These species generally have shallower root systems than the shrubs, but root densities are often as high as or higher than those of shrubs in the upper 0.5 meters of the soil profile. General differences in root depth distributions between grasses and shrubs result in resource partitioning in these shrub/grass systems.

This ecological site has low to moderate resilience to disturbance and resistance to invasion. Resilience increases with elevation, aspect, increased precipitation and increased nutrient availability. Five possible alternative stable states have been identified for this site.

Major Successional Stages of Forestland Development:

HERBACEOUS: Vegetation is dominated by grasses and forbs under full sunlight. This stage is experienced after a major disturbance such as crown fire. Skeleton forest (dead trees) remaining after fire or residual trees left following harvest have little or no effect on the composition and production of the herbaceous vegetation.

SHRUB-HERBACEOUS: Herbaceous vegetation and woody shrubs dominate the site. Various amounts of tree seedlings (less than 20 inches in height) may be present up to the point where they are obviously a major component of the vegetal structure.

SAPLING: In the absence of disturbance the tree seedlings develop into saplings (20 inches to 4½ feet in height) with a range in canopy cover of about 5 to 10 percent. Vegetation consists of grasses, forbs and shrubs in association with tree saplings.

IMMATURE FORESTLAND: The visual aspect and vegetal structure are dominated by Utah juniper trees greater than 4½ feet in height. The upper crown of dominant and co-dominant trees are cone or pyramidal shaped. Seedlings and saplings of Utah juniper are present in the understory. Dominants are the tallest trees on the site; co-dominants are 65 to 85 percent of the height of dominant trees. Understory vegetation is moderately influenced by a tree overstory canopy of about 10 to 20 percent.

MATURE FORESTLAND: The visual aspect and vegetal structure are dominated by Utah juniper that have reached or are near maximal heights for the site. Dominant trees average greater than five inches in diameter at one-foot stump height. Upper crowns of Utah juniper are typically either irregularly or smoothly flat-topped or rounded. Tree canopy cover ranges from 20 to 35 percent. Understory vegetation is strongly influenced by tree competition, overstory shading, duff accumulation, etc. Few tree seedlings and/or saplings occur in the understory. Infrequent, yet periodic, wildfire is presumed to be a natural factor influencing the understory of mature juniper forestlands. This stage of community development is assumed to be representative of this forestland site in the pristine environment.

OVER-MATURE FORESTLAND: In the absence of wildfire or other naturally occurring disturbances, the tree canopy on this site can become very dense. This stage is dominated by Utah juniper that have reached maximal heights for the site. Dominant and co-dominant trees average greater than five inches in diameter at one-foot stump height. Upper crowns are typically irregularly flat-topped or rounded. Understory vegetation is sparse or absent due to tree competition, overstory shading, duff accumulation, etc. Tree canopy cover is commonly greater than 50 percent.

Fire Ecology:

Historic fire occurrence was rare on these sites. Lightning-ignited fires were common but typically did not affect more than a few individual trees. Replacement fires were uncommon to rare (100 to 600 years) and occurred primarily during extreme fire behavior conditions. Spreading, low-intensity surface fires had a very limited role in molding stand structure and dynamics. Surface spread was more likely to occur in higher-density woodlands growing on more productive sites (Romme et al. 2009). Pre-settlement fire return intervals in the Great Basin National Park, Nevada were found to have a mean range between 50 to 100 years with north-facing slopes burning every 15 to 20 years and rocky landscapes with sparse understory very infrequently (Gruell 1999). Woodland dynamics are largely attributed to long-term climatic shifts (temperature, amounts and distribution of precipitation) and the extent and return intervals of fire (Miller and Tausch 2001). Limited data exists that describes fire histories across woodlands in the Great Basin. The infilling of younger trees into the old-growth stands and the expansion of trees into the surrounding sagebrush steppe ecological sites has increased the risk of loss of pre-settlement trees due to increased fire severity and size resulting from the increase in the abundance and landscape level continuity

of fuels (Miller et al. 2008).

Utah juniper is usually killed by fire, and is most vulnerable to fire when it is under four feet tall (Bradley et al. 1992). Larger trees have foliage farther from the ground and thicker bark and thus can survive low severity fires but mortality does occur when 60 percent or more of the crown is scorched (Bradley et al. 1992). Singleleaf pinyon is also most vulnerable to fire when less than four feet tall, however mature trees do not self-prune their dead branches, allowing for accumulated fuel in the crowns. This characteristic and the relative flammability of the foliage make individual mature trees susceptible to fire (Bradley et al. 1992). With the low production of the understory vegetation and low density of trees per acre, high severity fires within this plant community were historically not likely and rarely became crown fires (Bradley et al. 1992, Miller and Tausch 2001).

Juniper reestablishes by seed from nearby seed sources or surviving seeds. Junipers have a long-lived seed bank due to impermeable seed coats, immature or dormant embryos, and germination inhibitors that delay germination (Chambers et al. 1999). Chambers et al. (1999) found that Utah juniper seedlings were capable of establishing in interspace microhabitats as frequently as under sagebrush. Therefore, fire that removes both trees and understory shrubs in pinyon-juniper woodlands may not have a long-term effect on juniper reestablishment.

Initial response of native understory species following fire correlates closely with percent crown cover. In general, research indicates that understory response to disturbance is most productive when crown cover is at or below 20 percent. Beyond 30 percent, however, there is a rapid decline in understory species and soil seed reserves (Huber et al. 1999).

Wyoming big sagebrush is killed by fire and only regenerates from seed. Recovery time for Wyoming big sagebrush may require 50-120 or more years (Baker 2006). The introduction and expansion of cheatgrass, however, has dramatically altered the fire regime (Balch et al. 2013) and restoration potential of Wyoming big sagebrush communities.

The effect of fire on bunchgrasses relates to culm density, culm-leaf morphology, and the size of the plant. The initial condition of bunchgrasses within the site along with seasonality and intensity of the fire all factor into individual species' responses. For most forbs and grasses, the growing points are located at or below the soil surface providing relative protection from disturbances which decrease above ground biomass, such as grazing or fire. Thus, fire mortality is more correlated to duration and intensity of heat which is related to culm density, culm-leaf morphology, size of plant and abundance of old growth (Wright 1971, Young 1983). Season and severity of the fire will influence plant response, however. Plant response will also vary depending on post-fire soil moisture availability.

Fire will remove aboveground biomass from bluebunch wheatgrass but plant mortality is generally low (Robberecht and Defossé 1995) because the buds are underground (Conrad and Poulton 1966) or protected by foliage. Uresk et al. (1976) reported burning increased vegetative and reproductive vigor of bluebunch wheatgrass. Thus, bluebunch wheatgrass is generally slightly damaged by fire but is more susceptible in drought years (Young 1983). Plant response will vary depending on season, fire severity, fire intensity and post-fire soil moisture availability.

Indian ricegrass, a prominent grass on this site, is fairly fire tolerant (Wright 1985), which is likely due to its low culm density and below-ground plant crowns. Vallentine (1989) cites several studies in the sagebrush zone that classified Indian ricegrass as being slightly damaged from late summer burning. Indian ricegrass has also been found to reestablish on burned sites through seed dispersed from adjacent unburned areas (Young 1983, West 1994), thus the presence of surviving, seed producing plants facilitates the reestablishment of Indian ricegrass. Grazing management following fire to promote seed production and establishment of seedlings is important.

Thurber's needlegrass is moderately resistant to wildfire (Smith and Busby 1981), but can be severely damaged and have high mortality depending on season and severity of fire. Post-fire regeneration usually occurs from seed, but plants that are not completely killed by fire will continue growth during favorable conditions (Koniak 1985).

Sandberg bluegrass (*Poa secunda*), a minor component of this ecological site, has been found to increase following fire likely due to its low stature and productivity (Daubenmire 1975). Sandberg bluegrass may retard reestablishment of deeper rooted bunchgrass.

State and transition model

Ecosystem states

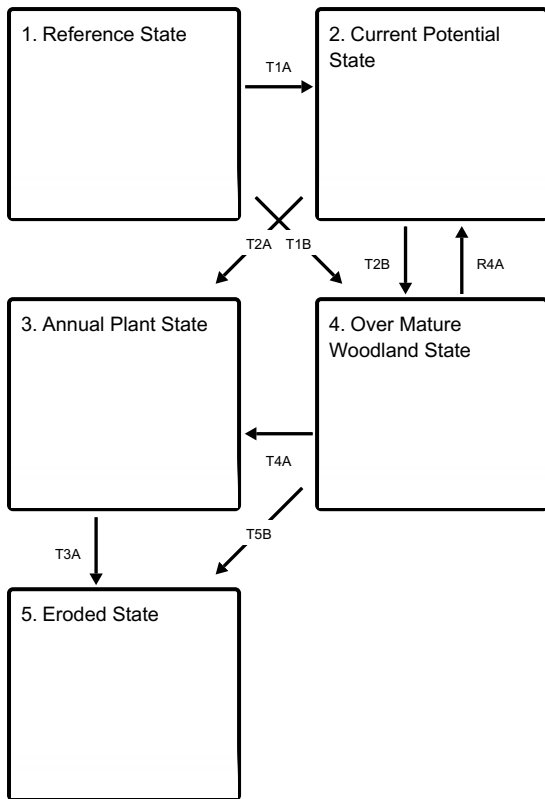

State 1 submodel, plant communities

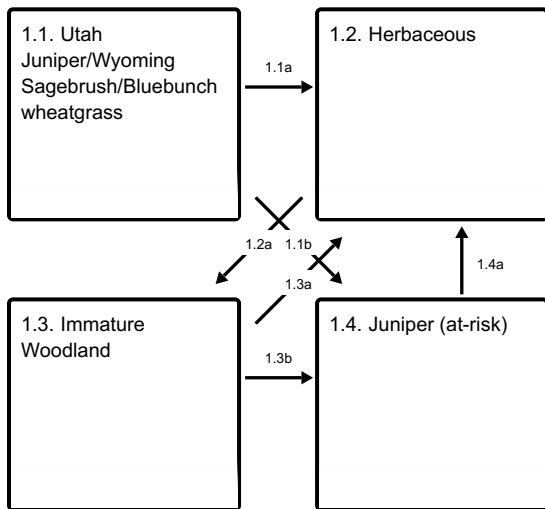

State 2 submodel, plant communities

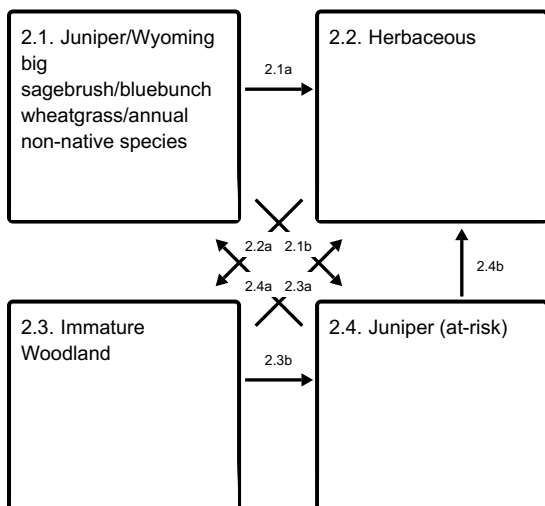

State 3 submodel, plant communities

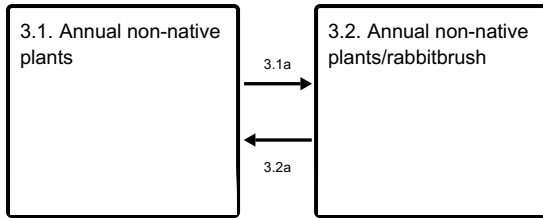

State 4 submodel, plant communities

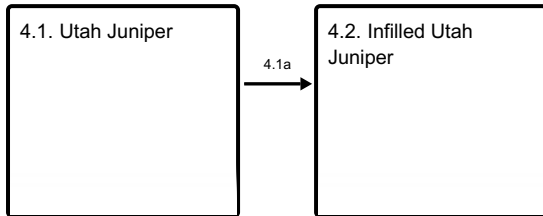

State 5 submodel, plant communities

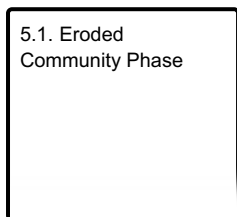

State 1 Reference State

The Reference State is representative of the natural range of variability under pristine conditions. This Reference State has four general community phases: an old-growth woodland phase, a shrub-herbaceous phase, an immature woodland phase, and an infilled woodland phase. State dynamics are maintained by interactions between climatic patterns and disturbance regimes. Negative feedbacks enhance ecosystem resilience and contribute to the stability of the state. These include the presence of all structural and functional groups, low fine fuel loads, and retention of organic matter and nutrients. Plant community phase changes are primarily driven by fire, periodic long-term drought, and/or insect or disease attack.

Community 1.1 Utah Juniper/Wyoming Sagebrush/Bluebunch wheatgrass

The reference plant community dominated by Utah juniper. Wyoming big sagebrush is the principal understory shrub. Bluebunch wheatgrass, Thurber's needlegrass, Indian ricegrass, and bluegrasses are the most prevalent understory grasses. Phlox and milkvetch are common understory forbs. Overstory tree canopy composition is 100 percent Utah juniper. An overstory canopy cover of 20 to 35 percent is assumed to be representative of tree dominance on this site in the pristine environment.

Forest overstory. MATURE FORESTLAND: The visual aspect and vegetal structure are dominated by Utah juniper that have reached or are near maximal heights for the site. Dominant trees average greater than five inches in diameter at one-foot stump height. Upper crowns of Utah juniper are typically either irregularly or smoothly flat-topped or rounded. Tree canopy cover ranges from 20 to 35 percent. Understory vegetation is strongly influenced by tree competition, overstory shading, duff accumulation, etc. Few tree seedlings and/or saplings occur in the understory. Infrequent, yet periodic, wildfire is presumed to be a natural factor influencing the understory of mature juniper forestlands. This stage of community development is assumed to be representative of this forestland site in the pristine environment.

Forest understory. Understory vegetative composition is about 50 percent grasses, 20 percent forbs and 30 percent shrubs and young trees when the average overstory canopy is medium (20 to 35 percent). Average understory production ranges from 200 to 500 pounds per acre with a medium canopy cover. Understory production includes the total annual production of all species within 4½ feet of the ground surface.

Table 7. Annual production by plant type

Plant Type	Low (Kg/Hectare)	Representative Value (Kg/Hectare)	High (Kg/Hectare)
Grass/Grasslike	112	196	280
Shrub/Vine	67	118	168
Forb	22	39	56
Tree	22	39	56
Total	223	392	560

Community 1.2 Herbaceous

This community phase is characterized by a post-fire shrub and herbaceous community. Bluebunch wheatgrass and other perennial grasses dominate. Forbs may increase post-fire but will likely return to pre-burn levels within a few years. Utah juniper seedlings up to 20 inches in height may be present. Black sagebrush may be present in unburned patches. Burned tree skeletons may be present; however these have little or no effect on the understory vegetation.

Community 1.3 Immature Woodland

This community phase is characterized by an immature woodland, with juniper trees averaging over 4.5 feet in height. Tree canopy cover is between 10 to 20 percent. Tree crowns are typically cone- or pyramidal-shaped. Understory vegetation consists of smaller tree seedling and saplings, as well as perennial bunchgrasses and shrubs.

Community 1.4 Juniper (at-risk)

This phase is dominated by Utah juniper. The stand exhibits mixed age classes and canopy cover exceeds 20 percent. The density and vigor of the black sagebrush and perennial bunchgrass understory is decreased. Bare ground areas are likely to increase. Mat-forming forbs may increase. This community is at risk of crossing a threshold; without proper management this phase will transition to the Infilled Tree State 3.0. This community phase is typically described as early Phase II woodland (Miller et al. 2008).

Pathway 1.1a Community 1.1 to 1.2

A high-severity crown fire will eliminate or reduce the Utah juniper overstory and the shrub component. This allows for the perennial bunchgrasses to dominate the site.

Pathway 1.1b Community 1.1 to 1.4

Time without disturbance such as fire, long-term drought, or disease will allow for the gradual infilling of Utah juniper and singleleaf pinyon.

Pathway 1.2a Community 1.2 to 1.3

Time without disturbance such as fire, long-term drought, or disease will allow for the gradual maturation of the Utah Juniper component. Black sagebrush reestablishes. Excessive herbivory may also reduce perennial grass understory.

Pathway 1.3a

Community 1.3 to 1.2

Fire reduces or eliminates tree canopy, allowing perennial grasses to dominate the site.

Pathway 1.3b

Community 1.3 to 1.4

Time without disturbance such as fire, long-term drought, or disease will allow for the gradual maturation of Utah juniper. Infilling by younger trees continues.

Pathway 1.4a

Community 1.4 to 1.2

A high-severity crown fire will eliminate or reduce the Utah juniper overstory and the shrub component which will allow for the perennial bunchgrasses to dominate the site.

State 2

Current Potential State

Community 2.1

Juniper/Wyoming big sagebrush/bluebunch wheatgrass/annual non-native species

This phase is characterized by a widely dispersed old-growth juniper trees with a Wyoming big sagebrush overstory and a deep-rooted perennial bunchgrass understory. The visual aspect is dominated by Utah juniper which makes up 10 to 20 percent of the overstory canopy cover. Trees have reached maximal or near maximal heights for the site and many tree crowns may be flat- or round-topped. Bluebunch wheatgrass and Indian ricegrass are the most prevalent grasses in the understory. Wyoming big sagebrush is the primary understory shrub. Forbs such as goldenweed (*Pyrrcoma*), phlox, and lupine are minor components. Overall, the understory is sparse with production ranging between 250 to 500 pounds per acre. Fires within this community are infrequent and likely small and patchy due to low fuel loads. This fire type will create a plant community mosaic that will include all/most of the following community phases within this state. Annual non-native species are present in trace amounts.

Community 2.2

Herbaceous

This community phase is characterized by a post-fire shrub and herbaceous community. Bluebunch wheatgrass and other perennial grasses dominate. Forbs may increase post-fire but will likely return to pre-burn levels within a few years. Juniper seedlings up to 20 inches in height may be present. Wyoming big sagebrush may be present in unburned patches. Burned tree skeletons may be present; however these have little or no effect on the understory vegetation. Annual non-native species generally respond well after fire and may be stable or increasing within the community.

Community 2.3

Immature Woodland

This community phase is characterized by an immature woodland, with Utah juniper trees averaging over 4.5 feet in height. Tree canopy cover is between 10 to 20 percent. Tree crowns are typically cone- or pyramidal-shaped. Understory vegetation consists of smaller tree seedling and saplings, as well as perennial bunchgrasses and shrubs. Annual non-native species are present.

Community 2.4

Juniper (at-risk)

This phase is dominated by Utah juniper. The stand exhibits mixed age classes and canopy cover exceeds 20 percent. The density and vigor of Wyoming big sagebrush and perennial bunchgrass understory is decreased. Bare ground areas are likely to increase. Mat-forming forbs may increase. Annual non-native species are present

primarily under tree canopies. This community is at risk of crossing a threshold, without proper management this phase will transition to the Infilled Tree State 3.0. This community phase is typically described as early Phase II woodland (Miller et al. 2008).

Pathway 2.1a **Community 2.1 to 2.2**

A high-severity crown fire will eliminate or reduce the Utah juniper overstory and the shrub component. This allows for the perennial bunchgrasses to dominate the site.

Pathway 2.1b **Community 2.1 to 2.4**

Time without disturbance such as fire, long-term drought, or disease will allow for the gradual infilling of Utah juniper.

Pathway 2.2a **Community 2.2 to 2.3**

Absence of disturbance over time

Pathway 2.3a **Community 2.3 to 2.2**

Fire

Pathway 2.3b **Community 2.3 to 2.4**

Absence of disturbance over time

Pathway 2.4a **Community 2.4 to 2.1**

Low intensity fire, insect infestation, or disease kills individual trees within the stand reducing canopy cover to less than 20 percent. Over time young trees mature to replace and maintain the old-growth woodland. The black sagebrush and perennial bunchgrass community increases in density and vigor. Annual non-natives present in trace amounts.

Pathway 2.4b **Community 2.4 to 2.2**

A high-severity crown fire will eliminate or reduce the Utah juniper overstory and the shrub component which will allow for the perennial bunchgrasses to dominate the site. Annual non-native grasses typically respond positively to fire and may increase in the post-fire community.

State 3 **Annual Plant State**

This state has two community phases. It is characterized by the dominance of annual non-native species such as cheatgrass and tansy mustard. Over time, rabbitbrush may dominate the overstory.

Community 3.1 **Annual non-native plants**

Cheatgrass, mustards and other non-native annual species dominate the site. Sandberg bluegrass and other perennial bunchgrasses may be present in trace amounts. Tree skeletons may dominate aspect for a number of

years. Rabbitbrush may be present.

Community 3.2

Annual non-native plants/rabbitbrush

Cheatgrass, mustards and other non-native annual species dominate the site with Rabbitbrush increasing. Sandberg bluegrass and other perennial bunchgrasses may be present in trace amounts.

Pathway 3.1a

Community 3.1 to 3.2

Absence of disturbance over time allows for sprouting shrubs to recover

Pathway 3.2a

Community 3.2 to 3.1

Fire

State 4

Over Mature Woodland State

This state has two community phases with a canopy cover ranging from 30 to 50 percent of Utah juniper. The phases exhibit a mixed age class. Older trees are at maximal height and upper crowns may be flat-topped or rounded. Younger trees are typically cone- or pyramidal-shaped. Understory vegetation is sparse due to increasing shade and competition from trees.

Community 4.1

Utah Juniper

Utah juniper dominates the aspect. Understory vegetation is thinning. Perennial bunchgrasses are sparse and Wyoming big sagebrush skeletons are as common as live shrubs due to tree competition for soil water, overstory shading, and duff accumulation. Tree canopy cover is greater than 30 percent. Annual non-native species are present or co-dominant in the understory. Bare ground areas are connected. This community phase is typically described as a Phase II woodland (Miller et al. 2008).

Community 4.2

Infilled Utah Juniper

Utah juniper dominates the aspect. Tree canopy cover exceeds 30 percent and may be as high as 50 percent. Understory vegetation is sparse to absent. Perennial bunchgrasses, if present exist in the dripline or under the canopy of trees. Wyoming sagebrush skeletons are common or the sagebrush has been dead long enough that only scattered limbs remain. Mat-forming forbs or Sandberg bluegrass may dominate interspaces. Annual non-native species are present and are typically found under the trees. Bare ground areas are large and interconnected. Soil redistribution may be extensive. This community phase is typically described as a Phase III woodland (Miller et al. 2008).

Pathway 4.1a

Community 4.1 to 4.2

Time without disturbance such as fire, long-term drought, or disease will allow for the gradual maturation of Utah juniper. Infilling by younger trees continues.

State 5

Eroded State

This state has one community phase dominated by Utah juniper. Abiotic factors including soil redistribution and erosion, soil temperature, soil crusting and sealing are primary drivers of ecological condition within this state. Soil

moisture, soil nutrients and soil organic matter distribution and cycling are severely altered due to degraded soil surface conditions. Utah juniper dominates the overstory and herbaceous species may be present in trace amount particularly under tree canopies. Regeneration of trees or herbaceous species is not evident.

Community 5.1

Eroded Community Phase

Soil erosion is driving site dynamics. Utah juniper and other species may still be present on the site, but are reduced in density and not controlling site processes. Regeneration of trees or herbaceous species is not evident. Site function is controlled by soil erosion, wind and soil temperature.

Transition T1A

State 1 to 2

Introduction of non-native annual species

Transition T1B

State 1 to 4

Time and lack of disturbance

Transition T2A

State 2 to 3

Catastrophic fire

Transition T2B

State 2 to 4

Absence of disturbance over time or a decrease in understory competition due to inappropriate grazing would allow for the Utah juniper trees to increase

Transition T3A

State 3 to 5

Multiple fires

Restoration pathway R4A

State 4 to 2

Thinning of trees and seeding or recovery of understory species

Transition T4A

State 4 to 3

Catastrophic fire

Transition T5B

State 4 to 5

Absence of disturbance over time allows for an increase in tree canopy cover and a continual decline in understory

Additional community tables

Table 8. Community 1.1 plant community composition

Group	Common Name	Symbol	Scientific Name	Annual Production (Kg/Hectare)	Foliar Cover (%)
Grass/Grasslike					
1	Primary Perennial Grasses			39–94	
	Thurber's needlegrass	ACTH7	<i>Achnatherum thurberianum</i>	39–94	–
2	Secondary Perennial Grasses			48–127	
	Indian ricegrass	ACHY	<i>Achnatherum hymenoides</i>	19–35	–
	bluebunch wheatgrass	PSSPS	<i>Pseudoroegneria spicata</i> ssp. <i>spicata</i>	19–35	–
	squirreltail	ELEL5	<i>Elymus elymoides</i>	3–19	–
	basin wildrye	LECI4	<i>Leymus cinereus</i>	3–19	–
	Sandberg bluegrass	POSE	<i>Poa secunda</i>	3–19	–
Forb					
3	Perennial			10–57	
	milkvetch	ASTRA	<i>Astragalus</i>	3–19	–
	phlox	PHLOX	<i>Phlox</i>	3–19	–
	goldenweed	PYRRO	<i>Pyrrocoma</i>	3–19	–
Shrub/Vine					
4	Primary Shrubs			57–104	
	mountain big sagebrush	ARTRV	<i>Artemisia tridentata</i> ssp. <i>vaseyana</i>	19–35	–
	Wyoming big sagebrush	ARTRW8	<i>Artemisia tridentata</i> ssp. <i>wyomingensis</i>	19–35	–
	antelope bitterbrush	PUTR2	<i>Purshia tridentata</i>	19–35	–
	milkvetch	ASTRA	<i>Astragalus</i>	3–17	–
	phlox	PHLOX	<i>Phlox</i>	3–17	–
Tree					
5	Evergreen			22–54	
	Utah juniper	JUOS	<i>Juniperus osteosperma</i>	19–35	–
	singleleaf pinyon	PIMO	<i>Pinus monophylla</i>	3–19	–

Animal community

Livestock Interpretations:

This site is suited to cattle and sheep grazing where terrain permits. Grazing management should be keyed to Thurber's needlegrass and bluebunch wheatgrass production. Thurber's needlegrass and bluebunch wheatgrass provide palatable, nutritious feed during the late spring and summer. New plants of these grasses are established entirely from seed and grazing practices should allow for ample seed production and seedling establishment.

Livestock will often concentrate on this site taking advantage of the shade and shelter offered by the tree overstory. Many areas are not used because of steep slopes and lack of adequate water. Attentive grazing management is required due to steep slopes and associated erosion hazards. Harvesting trees under a sound management program for fuelwood, posts or other products can open the tree canopy to allow increased production of understory species desirable for grazing.

Stocking rates vary with such factors as kind and class of grazing animal, season of use and fluctuations in climate. Actual use records for individual sites, a determination of the degree to which the sites have been grazed, and an evaluation of trend in site condition offer the most reliable basis for developing initial stocking rates.

Selection of initial stocking rates for given grazing units is a planning decision. This decision should be made ONLY

after careful consideration of the total resources available, evaluation of alternatives for use and treatment, and establishment of objectives by the decisionmaker.

This site is suitable for livestock grazing. Grazing management considerations include timing, intensity and duration of grazing. The history of livestock grazing in the pinyon-juniper ecosystem dates back to more than 200 years, depending on the particular locality within the ecosystem (Hurst 1975). Historically, pinyon-juniper woodlands were much more open and supported a diverse understory that provided forage for both livestock and wildlife. Historic livestock overuse and increased stand densities have reduced the carrying capacity of these pinyon-juniper stands and many current stands only provide shade and shelter for livestock.

Black sagebrush palatability has been rated as moderate to high depending on the ungulate and the season of use (Horton 1989, Wambolt 1996). The palatability of black sagebrush increase the potential negative impacts on remaining black sagebrush plants from grazing or browsing pressure following fire (Wambolt 1996). Pronghorn utilize black sagebrush heavily (Beale and Smith 1970). On the Desert Experimental Range, black sagebrush was found to comprise 68 percent of pronghorn diet even though it was only the third most common plant. Fawns were found to prefer black sagebrush, utilizing it more than all other forage species combined (Beale and Smith 1970). Domestic livestock will also utilize black sagebrush. The domestic sheep industry that emerged in the Great Basin in the early 1900s was largely based on wintering domestic sheep in black sagebrush communities (Mozingo 1987). Domestic sheep will browse black sagebrush during all seasons of the year depending on the availability of other forage species with greater amounts being consumed in fall and winter. Black sagebrush is generally less palatable to cattle than to domestic sheep and wild ungulates (McArthur et al. 1982); however, cattle use of black sagebrush has been shown to be greatest in fall and winter (Schultz and McAdoo 2002), with only trace amounts being consumed in summer (Van Vuren 1984).

Inappropriate grazing management during the growing season will cause a decline in understory plants such as bluebunch wheatgrass, Indian rice ricegrass and Thurber's needlegrass. Bluebunch wheatgrass is moderately grazing tolerant and is very sensitive to defoliation during the active growth period (Blaisdell and Pechanec 1949, Laycock 1967, Anderson and Scherzinger 1975, Britton et al. 1990). Herbage and flower stalk production was reduced with clipping at all times during the growing season; however, clipping was most harmful during the boot stage (Blaisdell and Pechanec 1949). Tiller production and growth of bluebunch was greatly reduced when clipping was coupled with drought (Busso and Richards 1995). Mueggler (1975) estimated that low vigor bluebunch wheatgrass may need up to 8 years rest to recover. Although an important forage species, it is not always the preferred species by livestock and wildlife.

Thurber's needlegrass is an important forage source for livestock and wildlife in the arid regions of the west (Ganskopp 1988). Although the seeds are not injurious, grazing animals avoid them when they begin to mature. Sheep, however, have been observed to graze the leaves closely, leaving stems untouched (Eckert and Spencer 1987). Heavy grazing during the growing season has been shown to reduce the basal area of Thurber's needlegrass (Eckert and Spencer 1987), suggesting that both seasonality and utilization are important factors in management of this plant. A single defoliation, particularly during the boot stage, was found to reduce herbage production and root mass thus potentially lowering the competitive ability of this needlegrass (Ganskopp 1988). Indian ricegrass is a preferred forage species for livestock and wildlife (Cook 1962, Booth et al. 2006). This species is often heavily utilized in winter because it cures well (Booth et al. 2006). It is also readily utilized in early spring as it is a source of green feed before most other perennial grasses have produced new growth (Quinones 1981). Booth et al. (2006) note that the plant does well when utilized in winter and spring. Cook and Child (1971), however, found that repeated heavy grazing reduced crown cover, which may reduce seed production, density, and basal area of these plants. Additionally, heavy early spring grazing reduces plant vigor and stand density (Stubbenieck 1985). In eastern Idaho, productivity of Indian ricegrass was at least 10 times greater in undisturbed plots than in heavily-grazed ones (Pearson 1965). Cook and Child (1971) found significant reduction in plant cover after 7 years of rest from heavy (90 percent) and moderate (60 percent) spring use. The seed crop may be reduced where grazing is heavy (Bich et al. 1995). Tolerance to grazing increases after May, thus spring deferment may be necessary for stand enhancement (Pearson 1964, Cook and Child 1971); however, utilization of less than 60 percent is recommended.

Reduced bunchgrass vigor or density provides an opportunity for Sandberg bluegrass, mat-forming forbs and/or cheatgrass and other invasive species to occupy interspaces. Sandberg bluegrass increases under grazing pressure (Tisdale and Hironaka 1981) and is capable of co-existing with cheatgrass. Excessive sheep grazing favors Sandberg bluegrass; however, where cattle are the dominant grazers, cheatgrass often dominates (Daubenmire 1970). Depending on the season of use, the grazer and site conditions, either Sandberg bluegrass or cheatgrass may become the dominant understory with inappropriate grazing management. Field surveys indicate native, mat-forming forbs may also increase with decreased bunchgrass density.

Wildlife Interpretations:

This site has high value for mule deer during the winter. Juniper trees provide shelter from winter storms and juniper foliage is also browsed during the winter. Sites where water is available offer good quail habitat and are visited seasonally by mourning dove. It is also used by various song birds, rodents, reptiles and associated predators natural to the area.

Pinyon-juniper woodlands provide a diversity of habitat for wildlife. Although the foliage of pinyon and juniper varies in palatability among fauna, the pinyon nuts and juniper berries are preferred by many species. The understory species provide fruits and browse for large ungulates, small mammals, birds and beavers (Wildlife Action Plan Team 2012).

Ungulates will use pinyon and juniper trees for cover and graze the foliage. The understory species also provide critical browse for deer. The trees provide important cover for mule deer (*Odocoileus hemionus*), elk (*Cervus canadensis*) wild horses, mountain lions (*Puma concolor*), bobcats (*Lynx rufus*) and pronghorns (*Antilocapra americana*) (Gottfried and Severson 1994, Coates and Schemnitz 1994, Logan and Irwin 1985, Evans 1988). Mule deer is considered the dominant big game species in the pinyon-juniper woodland and depend heavily on these woodlands for cover, shelter, and emergency forage during severe winters (Frischknecht 1975). Mule deer will eat singleleaf pinyon and juniper foliage, using the foliage moderately in winter, spring, and summer (Kufeld et al. 1973). Deep snows in higher elevation forest zones force mule deer and elk down into pinyon-juniper habitats during winter. This change in habitat allows mule deer and elk to browse the dwarf trees and shrubs (Gottfried and Severson 1994).

The diet of pronghorn antelope varies considerably; however, singleleaf pinyon was shown to comprise 1 to 2 percent of winter diet of pronghorn antelope that occur in pinyon-juniper habitat. Desert bighorn sheep (*Ovis nelson*) may utilize pinyon-juniper habitat, but only where the terrain is rocky and steep (Gottfried et al. 2000). Gray foxes, bobcats (*Lynx rufus*), coyotes (*Canis latrans*), weasels (*Mustela frenata*), skunks (*Mephitis spp.*), badgers (*Taxidea taxus*), and ringtail cats (*Bassariscus astutus*) search for prey in pinyon-juniper habitat woodlands (Short and McCulloch 1977).

Juniper "berries" or berry-cones are eaten by black-tailed jackrabbits (*Lepus californicus*) and coyotes (Gese et al. 1988, Kitchen et al. 2000). A study by Kitchen et al. (2000) conducted in juniper-pinyon habitat found the main vegetation in coyote scat was mainly grass seeds or juniper berries. Jackrabbits are a major dispenser of juniper seeds (Schupp et al. 1999). The pinyon mouse (*Peromyscus truei*) is a pinyon-juniper obligate and uses the woodlands for cover and food (Hoffmeister 1981). Other small mammals include the porcupine (*Hystricomorph hystricidae*), desert cottontail (*Sylvilagus audubonii*), Nuttall's cottontail (*S. nuttallii*), deer mouse (*Peromyscus maniculatus*), Great Basin pocket mouse (*Perognathus parvus*), chisel-toothed kangaroo rat (*Dipodomys microps*) and desert woodrat (*Neotoma lepida*) (Turkowski and Watkins 1976).

Many bird species are associated with the pinyon-juniper habitat; some are permanent residents, some summer residents, and some winter residents, depending upon location. For birds and bats, the woodland provides structure for nesting and roosting as well as locations for foraging. Many bird species depend on juniper berry-cones and pine nuts as fall and winter food sources (Balda and Masters 1980). Several bird species are obligates including the gray flycatcher (*Epidonax wrightii*), scrub jay (*Aphelocoma californica*), plain titmouse (*Parus inornatus ridgwayi*), and gray vireo (*Vireo vicinior*). There are also several semi-obligates, including the black-chinned hummingbird (*Archilochus alexandri*), ash-throated flycatcher (*Myiarchus cinerascens*), pinyon jay (*Gymnorhinus cyanocephalus*), American bushtit (*Psaltriparus minimus*), Bewick's wren (*Thryomanes bewickii*), Northern mockingbird (*Mimus polyglottos*), blue-gray gnatcatcher (*Poliophtila caerulea*), black-throated gray warbler (*Dendroica nigrescens*), house finch (*Haemorhous mexicanus*), spotted towhee (*Pipilo maculatus*), lark sparrow (*Chondestes grammacus*) and black-chinned sparrow (*Zonotrichia atricapilla*) (Balda and Masters 1980). Ferruginous hawk (*Buteo regalis*), a conservation priority species due to recent population declines in Nevada, nests in older trees of sufficient size and structure to support their large nest platforms (Holechek 1981).

Diurnal reptiles, including the sagebrush swift (*Sceloporus graciosus*), blue-bellied lizard (*Sceloporus elongates*), western collard lizard, the Great Basin rattlesnake (*Pituophis melanoleucus*), Great Basin gopher snake (*Pituophis catenifer*) and horned lizard, also occur in Utah juniper habitat (Frischknecht 1975). The distribution of most of herpetofauna present in pinyon-juniper woodlands is poorly understood, however, and more research and management are needed.

Hydrological functions

The hydrologic cover condition of this site is poor in a representative stand. Hydrologic soil groups are C and D. The average runoff curve is about 85 for group C soils and about 90 for group D. Soils. Runoff is high to very high. Permeability is moderately slow to moderately rapid.

Recreational uses

The trees on this site provide a welcome break in an otherwise open landscape. It has potential for hiking, cross-country skiing, camping, and deer and upland game hunting.

Wood products

This forestland community is of low site quality for tree production. Site index ranges from 35 to 50 (Howell, 1940).

Productivity Class: 0.2 to 0.3

CMAI*: 2.7 to 4.6 ft³/ac/yr;

0.2 to 0.3 m³/ha/yr.

Culmination is estimated to be at 100 years.

*CMAI: is the culmination of mean annual increment or highest average growth rate of the stand in the units specified.

Fuelwood Production: 3 to 6 cords per acre for stands averaging 5 inches in diameter at 1 foot height with a medium canopy cover. There are about 274,000 gross BTUs heat content per cubic foot of Utah juniper. Solid wood volume in a cord varies but usually ranges from 65 to 90 cubic feet. Assuming an average of 75 cubic feet of solid wood per cord, there are about 20.6 million BTUs of heat value in a cord of Utah juniper fire wood.

Posts (7 foot): About 25 to 40 posts per acre in stands of medium canopy.

MANAGEMENT GUIDES AND INTERPRETATIONS

1. LIMITATIONS AND CONSIDERATIONS

- a. Potential for sheet and rill erosion is moderate to severe depending on slope.
- b. Moderate equipment limitations on steeper slopes and moderate to severe equipment limitations on sites having extreme surface stoniness.
- c. Proper spacing is the key to a well managed, multiple use and multi-product juniper woodland.

2. ESSENTIAL REQUIREMENTS

- a. Adequately protect from wildfire.
- b. Protect soils from accelerated erosion.
- c. Apply proper grazing management.

3. SILVICULTURAL PRACTICES

- a. Harvest cut selectively or in small patches size dependent upon site conditions) to enhance forage production.
 - 1) Thinning and improvement cutting - Removal of poorly formed, diseased and low vigor trees for fuelwood.
 - 2) Harvest cutting - Selectively harvest surplus trees to achieve desired spacing. Save large, healthy, full-crowned singleleaf pinyon trees for nut producers. Do not select only "high grade" trees during harvest.
 - 3) Slash Disposal - broadcasting slash improves reestablishment of native understory herbaceous species and establishment of seeded grasses and forbs after tree harvest.
 - 4) Spacing Guide - D+15
- b. Prescription burning program to maintain desired canopy cover and manage site reproduction.
- c. Mechanical tree removal (i.e. chaining) is not recommended on this site.
- d. Pest control - Porcupines can cause extensive damage and populations should be controlled.
- e. Fire hazard - Fire usually not a problem in well-managed, mature stands.

Other products

Utah juniper berries were used by Native Americans for food. Native Americans made tea from big sagebrush leaves. They used the tea as a tonic, an antiseptic, for treating colds, diarrhea, and sore eyes, and as a rinse to ward off ticks. Big sagebrush seeds were eaten raw or made into meal.

Other information

Wyoming big sagebrush is used for stabilizing slopes and gullies and for restoring degraded wildlife habitat, rangelands, mine spoils, and other disturbed sites. It is particularly recommended on dry upland sites where other shrubs are difficult to establish.

Table 9. Representative site productivity

Common Name	Symbol	Site Index Low	Site Index High	CMAI Low	CMAI High	Age Of CMAI	Site Index Curve Code	Site Index Curve Basis	Citation
Utah juniper	JUOS	35	50	3	5	–	–	–	

Inventory data references

Soils and physiographic features were gathered from the NASIS database.

Type locality

Location 1: Elko County, NV	
Township/Range/Section	T39N R62E S4
General legal description	About 4 air miles northwest of Bishop Creek Reservoir, lower elevations of Snake Mountains, Elko County, Nevada.

Other references

Anderson, E. W. and R. J. Scherzinger. 1975. Improving quality of winter forage for elk by cattle grazing. *Journal of Range Management*: 120-125.

Balda, R. P. and N. Masters. 1980. Avian communities in the pinyon-juniper woodland: A descriptive analysis. In: DeGraaf, R. M., technical coordinator. *Management of western forests and grasslands for nongame birds: Workshop proceedings. 1980 February 11-14; Salt Lake City, UT. Gen. Tech. Rep. INT-86. Ogden, UT: U.S. Department of Agriculture, Forest Service, Intermountain Forest and Range Experiment Station: 146-169.*

Beale, D. M. and A. D. Smith. 1970. Forage use, water consumption, and productivity of pronghorn antelope in western Utah. *The Journal of Wildlife Management* 34: 570-582.

Beetle, A. A. 1960. A study of sagebrush: The section tridentatae of *Artemisia*. Bulletin 368. University of Wyoming. Wyoming Agricultural Experiment Station. 83 pp.

Bich, B. S., J. L. Butler, and C. A. Schmidt. 1995. Effects of differential livestock use on key plants species and rodent populations within selected *Oryzopsis hymenoides*/*Hilaria jamesii* communities of Glen Canyon National Recreation Area. *The Southwestern Naturalist* 40:281-287.

Blaisdell, J.P. and J.F. Pechanec. 1949. Effects of herbage removal at various dates on vigor of bluebunch wheatgrass and arrowleaf balsamroot. *Ecology* 30(3): 298-305.

Boltz, M. 1994. Factors influencing postfire sagebrush in south-central Idaho. In *Proceedings -- Ecology and management of annual rangelands. Boise, ID: U.S. Department of Agriculture, Forest Service, Intermountain Research Station. Gen. Tech. Rep. INT-GTR-313. p 281-290.*

Booth, D. T., C. G. Howard, and C. E. Mowry. 2006. 'Nezpar' Indian ricegrass: Description, justification for release, and recommendations for use. *Rangelands Archives* 2: 53-54.

Bradley, A. F., N. V. Noste, and W. C. Fischer. 1992. Fire ecology of forests and woodlands in Utah. Ogden, UT: U.S. Department of Agriculture, Forest Service, Intermountain Research Station. Gen. Tech. Rep. INT-287.

- Britton, C. M., G. R. McPherson, and F. A. Sneva. 1990. Effects of burning and clipping on five bunchgrasses in eastern Oregon. *Great Basin Naturalist* 50: 115-120.
- Bunting, S. 1994. Effects of fire on juniper woodland ecosystems in the Great Basin. In: Monsen, S.B. and S.G. Kitchen (compilers). *Proceedings - Ecology and management of annual rangelands, 18-22 May 1992, Boise, ID.* Ogden, UT: U.S. Department of Agriculture, Forest Service, Intermountain Research Station. Gen. Tech. Rep. INT-GTR-313.
- Busso, C. A. and J. H. Richards. 1995. Drought and clipping effects on tiller demography and growth of two tussock grasses in Utah. *Journal of Arid Environments* 29: 239-251.
- Caudle, D., J. DiBenedetto, M. Karl, H. Sanchez, and C. Talbot. 2013. *Interagency Ecological Site Handbook for Rangelands.* Available at: <http://jornada.nmsu.edu/sites/jornada.nmsu.edu/files/InteragencyEcolSiteHandbook.pdf>. Accessed 4 October 2013.
- Chambers, J. C., B. A. Bradley, C. S. Brown, C. D'Antonio, M. J. Germino, J. B. Grace, S. P. Hardegree, R. F. Miller, and D. A. Pyke. 2013. Resilience to stress and disturbance, and resistance to *Bromus tectorum* L. invasion in cold desert shrublands of western North America. *Ecosystems*: 1-16.
- Chambers, J.C., E.W. Schupp and S.B. Vander Wall. 1999. Seed dispersal and seedling establishment of pinyon and juniper species within the pinyon-juniper woodland. In: *Proceedings: Ecology and management of pinyon-juniper communities within the interior west.* Ogden, UT, USA: US Department of Agriculture, Forest Service, Rocky Mountain Research Station, RMRS-P-9: 29-34.
- Christopherson, J. 2014. *Dwarf Mistletoe (Arceuthobium spp.).* Carson City, NV: Nevada Division of Forestry.
- Coates, K.P. and S.D. Schemnitz. 1994. Habitat use and behavior of male mountain sheep in foraging associations with wild horses. *Great Basin Naturalist* 54:86-90.
- Conrad, C. E. and C. E. Poulton. 1966. Effect of a wildfire on Idaho fescue and bluebunch wheatgrass. *Journal of Range Management*: 138-141.
- Cook, C. W. 1962. An evaluation of some common factors affecting utilization of desert range species. *Journal of Range Management* 15:333-338.
- Cook, C.W. and R.D. Child. 1971. Recovery of desert plants in various stages of vigor. *Journal of Range Management* 24(5):339-343.
- Daubenmire, R. 1970. *Steppe vegetation of Washington.* 131 pp.
- Daubenmire, R. 1975. Plant succession on abandoned fields, and fire influences in a steppe area in southeastern Washington. *Northwest Science* 49:36-48.
- Durham, G. 2014. *Juniper Pocket Rot (Pyrofomes demidoffii).* Carson City, NV: Nevada Division of Forestry.
- Eckert, R. E., Jr. and J. S. Spencer. 1987. Growth and reproduction of grasses heavily grazed under rest-rotation management. *Journal of Range Management* 40: 156-159.
- Eddleman, L.E., P.M. Miller, R.F. Miller, P.L. Dysart. 1994. *Western juniper woodlands of the Pacific Northwest: Science assessment.* Corvallis, OR: Department of Rangeland Resources, Oregon State University.
- Emerson, F.W. 1932. The tension zone between the Grama grass and pinyon-juniper associations in northeastern New Mexico. *Ecology* 13:347-358.
- Evans, Raymond A. 1988. *Management of pinyon-juniper woodlands.* Ogden, UT: U.S. Department of Agriculture, Forest Service, Intermountain Research Station. Gen. Tech. Rep. INT-249. 34 pp.
- Frischknecht, N.C. 1975. Native faunal relationships within the pinyon-juniper ecosystem. In: *Proceedings of The*

Pinyon-Juniper Ecosystem: A Symposium. May 1975. Logan, UT: Utah State University. p. 55-65.

Ganskopp, D. 1988. Defoliation of Thurber needlegrass: Herbage and root responses. *Journal of Range Management* 41:472-476.

Gese, E.M., O.J. Rongstad and W.R. Mytton 1988. Home range and habitat use of coyotes in southeastern Colorado. *Journal of Wildlife Management* 52: 640-646.

Gottfried, G.J. and K.E. Severson. 1994. Managing pinyon-juniper woodlands. *Rangelands* 16:234-236.

Gottfried, G.J.; Folliott, P.F.; Baker, M.B., Jr. 2000. Measurement of historical inventory locations to assess changes in forest and woodlands in Arizona. In: Cook, J.E.; Oswald, B.P. (comp). *First Biennial North American Forest Ecology Workshop*. June 24-26, 1997; North Carolina State University, Raleigh, NC. 51-52 p.

Gruell, G.E. 1999. Historical and modern roles of fire in pinyon-juniper. In: *Proceedings: Ecology and management of pinyon-juniper communities within the interior west*. Ogden, UT, USA: US Department of Agriculture, Forest Service, Rocky Mountain Research Station. RMRS-P-9:35-46.

Hepting, G.H. 1971. Diseases of forest and shade trees of the United States. U.S. Department of Agriculture Handbook 386. 658 pp.

Heyerdahl, E.K., Miller, R.F, and Parsons, R.A. 2006. History of fire and Douglas-fir establishment in a savanna and sagebrush grassland mosaic, southwestern Montana, USA. *Forest Ecology and Management*. 230:107-118.

Hoffmeister, D.F. 1981. Mammalian species: *Peromyscus truei*. *The American Society of Mammalogists* 161:1-5.

Holechek, J. L. 1981. Brush control impacts on rangeland wildlife. *Journal of Soil and Water Conservation* 36: 265-269.

Holmes, R.L., R.K., Adams, H.C. Fritts. 1986. Tree ring chronologies of western North America: California, eastern Oregon and northern Great Basin. *Chronology Series VI*. Laboratory of Tree Ring Research, University of Arizona, Tucson, AZ 183p.

Horton, H. 1989. Interagency forage and conservation planting guide for Utah. Extension circular 433. Logan UT: Utah State University, Utah Cooperative Extension Service.

Houghton, J.G., C.M. Sakamoto, and R.O. Gifford. 1975. Nevada's weather and climate, special publication 2. Nevada Bureau of Mines and Geology, Mackay School of Mines, University of Nevada, Reno, NV.

Howell, J., 1940. Pinyon and juniper: a preliminary study of volume, growth, and yield. *Regional Bulletin* 71. Albuquerque, NM: USDA, SCS; 90p.

Huber, A., S. Goodrich, K. Anderson. 1999. Diversity with successional status in the pinyon-juniper/mountain mahogany/bluebunch wheatgrass community type near Dutch John, Utah. In: US Department of Agriculture, Forest Service, Rocky Mountain Research Station Proceedings. RMRSP-9.

Hurst, W.D. 1975. Management strategies within the pinyon-juniper ecosystem. In: *Proceedings of the pinyon-juniper ecosystem: A symposium*. Utah State University, Logan, UT. p. 187-192.

Jameson, D.A. 1970. Degradation and accumulation on inhibitory substances from *Juniperus osteosperma* (Torr.) Little. *Plant Soil* 33: 213-224.

Jordan, M., 1974. An Inventory of two selected woodland sites in the Pine Nut Hills of Western Nevada.

Kitchen, A.M., E.M. Gese, and E.R. Schauster. 2000. Changes in coyote activity patterns due to reduced exposure to human persecution. *Canada Journal of Zoology* 78:853-857

Kitchen, S. G. and E. D. McArthur. 2007. Big and black sagebrush landscapes. In: *Fire ecology and management of*

the major ecosystems of Southern Utah. Fort Collins, CO: U.S. Department of Agriculture, Forest Service, Rocky Mountain Research Station. General Technical Report RMRS-GTR-202. p 73-95.

Koniak, S. 1985. Succession in pinyon-juniper woodlands following wildfire in the Great Basin. *The Great Basin Naturalist* 45:556-566.

Kufeld, R.C., O.C. Wallmo and C. Feddema. 1973. Foods of the rocky mountain mule deer. Rocky Mountain Forest and Range Experiment Station. USDA Forest Service, Research Paper RM-111.

Laycock, W. A. 1967. How heavy grazing and protection affect sagebrush-grass ranges. *Journal of Range Management*:206-213.

Logan, K. A., Irwin, L. L. 1985. Mountain lion habitats in the Big Horn Mountains, Wyoming. *Wildlife Society Bulletin* 13: 257-262.

McArthur, E. D., A. Blaner, A. P. Plummer, and R. Stevens. 1982. Characteristics and hybridization of important intermountain shrubs: 3. Sunflower family. *En Ref. in Forest. Abstract* 43: 2176.

Meyer, S. E. 2008. *Artemisia L. - sagebrush*. In: F. T. Bonner and R. P. Karrfalt, editors. *The Woody Plant Seed Manual*. Agriculture Handbook 727. Washington, DC: U.S. Department of Agriculture, Forest Service. p 274-280.

Miller, R.F. and R.J. Tausch. 2001. The role of fire in pinyon and juniper woodlands: A descriptive analysis. In: Galley, K.E.M., Wilson, T.P. eds. *Invasive species: The role of fire in the control and spread of invasive species symposium*. Miscellaneous Publication No. 11. Tallahassee, FL: Tall Timbers Research Station. p 15-30.

Miller, R.F. and T.J. Rose. 1995. Historic expansion of *Juniperus occidentalis* (western juniper) in Southeastern Oregon. *Great Basin Naturalist* 55:37-45.

Miller, R.F. and T.J. Rose. 1999. Fire history and western juniper encroachment in sagebrush steppe. *Journal of Range Management* 52: 550-559.

Miller, R.F. R.J. Tausch, E.D. McArthur, D.D. Johnson and S.C. Sanderson. 2008. Age structure and expansion of pinyon-juniper woodlands: A regional perspective in the inter-mountain west. USDA Forest Service. RMRS-RP-69. p 1-13.

Miller, R.F., R.J. Tausch and W. Waichler. 1999. Old-growth juniper and pinyon woodlands. In: Monsen, S.D. and R. Stevens. *Comps. Proceedings: Ecology and management of pinyon-juniper communities within the interior west*, 15-12 September 1997, Provo, UT. Logan UT:USDA, Forest Service. RMRS-P-9. p 375-384.

Mozingo, H. N. 1987. *Shrubs of the Great Basin: A natural history*. University of Nevada Press, Reno NV.

Mueggler, W. F. 1975. Rate and pattern of vigor recovery in Idaho fescue and bluebunch wheatgrass. *Journal of Range Management* 28:198-204.

National Oceanic and Atmospheric Administration. 2004. *The North American Monsoon*. Reports to the Nation. National Weather Service, Climate Prediction Center. Available online: <http://www.weather.gov/>

Noy-Meir, I. 1973. Desert ecosystems: Environment and producers. *Annual review of ecology and systematics*. 4: 25-51.

Pearson, L. 1964. Effect of harvest date on recovery of range grasses and shrubs. *Agronomy Journal* 56:80-82.

Pearson, L.C. 1976. Primary production in grazed and ungrazed desert communities of eastern Idaho. *Ecology* 46(3): 278-285.

Quinones, F. A. 1981. Indian ricegrass evaluation and breeding. Bulletin 681. Las Cruces, NM: New Mexico State University, Agricultural Experiment Station. p 19.

- Robberecht, R. and G. Defossé. 1995. The relative sensitivity of two bunchgrass species to fire. *International Journal of Wildland Fire* 5: 127-134.
- Romme, W., C. Allen, J. Bailey, W. Baker, B. Bestelmeyer, P. Brown, K. Eisenhart, L. Floyd-Hanna, D. Huffman, B. Jacobs, R. Miller, E. Muldavin, T. Swetnam, R. Tausch, and P. Weisberg. 2009. Historical and modern disturbance regimes on pinon-juniper vegetation in the western U.S. *Rangeland Ecology and Management* 62:203-222.
- Schultz, B. W. and J. K. McAdoo. 2002. Common sagebrush in Nevada. Special publication SP-02-02. Reno, NV: University of Nevada, Cooperative Extension.
- Schupp, E.W., J.C. Chambers, S.B. Vander Wall, J.M. Gomez, M. Fuentes. 1999. Piñon and juniper seed dispersal and seedling recruitment at woodland ecotones. In: E. D. McArthur, K. W. Ostler, L. Carl [comps.] *Proceedings: Shrubland ecotones; 1998 August 12-14; Ephraim UT. Proc. RMRS-P-11. Ogden UT: U.S. Department of Agriculture, Forest Service, Rocky Mountain Research Station. p. 66-70.*
- Stevens, R., K. R. Jorgensen, and J. N. Davis. 1981. Viability of seed from thirty-two shrub and forb species through fifteen years of warehouse storage. *Western North American Naturalist* 41:274-277.
- Stubbenieck, J. L. 1985. Nebraska range and pasture grasses: (including grass-like plants). Lincoln, NE: University of Nebraska, Department of Agriculture Cooperative Extension Service.
- Tausch, R. J. 1999. Historic pinyon and juniper woodland development. In: *Proceedings: Ecology and management of pinyon-juniper communities within the interior west. Ogden, UT: US Department of Agriculture, Forest Service, Rocky Mountain Research Station. RMRS-P-9:12-19.*
- Tausch, R. J. and N. E. West. 1988. Differential establishment of pinyon and juniper following fire. *American Midland Naturalist*:174-184.
- Tisdale, E. W. and M. Hironaka. 1981. The sagebrush-grass region: A review of the ecological literature. University of Idaho, Forest, Wildlife and Range Experiment Station.
- Tueller, P.T., and J.E. Clark. 1975. Autecology of pinyon-juniper species of the Great Basin and Colorado Plateau. In: *Proceedings of the pinyon-juniper ecosystem: A symposium. Utah State University, Logan, UT. p. 27-40.*
- Turkowski, F. J. and R. K. Watkins. 1976. White-throated woodrat (*Neotoma albigula*) habitat relations in modified pinyon-juniper woodland of southwestern New Mexico. *Journal of Mammalogy*. 57: 586-591.
- Uresk, D. W., J. F. Cline, and W. H. Rickard. 1976. Impact of wildfire on three perennial grasses in south-wentral Washington. *Journal of Range Management* 29:309-310.
- USDA-NRCS. 2000. National Forestry Manual - Part 537. Washington, D.C. Fire Effects Information System [Online]. <http://www.fs.fed.us/feis>
- Vallentine, J. F. 1989. Range development and improvements. Academic Press, Inc. 524 p.
- Van Vuren, D. 1984. Summer diets of bison and cattle in southern Utah. *Journal of Range Management* 37:260-261.
- Wambolt, C. L. 1996. Mule deer and elk foraging preference for four sagebrush taxa. *Journal of Range Management* 49:499-503.
- Weisberg, P.J. and W.K. Dongwook. 2012. Old Tree morphology in singleleaf pinyon pine (*Pinus monophylla*). *Forest Ecology and Management* 263: 67-73.
- West, N. E. 1994. Effects of fire on salt-desert shrub rangelands. In *Proceedings - Ecology and management of annuals rangelands*, Boise, ID: USDA Forest Service, Intermountain Research Station. General Technical Report INT-313.

West, N.E., K.H. Rea, and R.J. Tausch. 1975. Basic synecological relationships in juniper-pinyon woodlands. In: Proceedings of the pinyon-juniper ecosystem: A symposium. Utah State University, Logan, UT. p 41-52.

West, N.E., R.J. Tausch, and P.T. Tueller. 1998. A management oriented classification of pinyon-juniper woodlands in the Great Basin. Ogden, UT: USDA Forest Service. Gen. Tech. Rep. RMRS-GTR-12. pp. 43-52.

Wildlife Action Plan Team. 2012. Nevada wildlife action plan. Nevada Department of Wildlife, Reno, NV.

Wright, H. A. 1971. Why squirreltail is more tolerant to burning than needle-and-thread. Journal of Range Management 24: 277-284.

Wright, H. A. 1985. Effects of fire on grasses and forbs in sagebrush-grass communities. In Rangeland fire effects; a symposium: Boise, ID, USDI-BLM. p 12-21.

Wright, H.A. L.F. Neuenschwander, and C.M. Britton. 1979. The role and use of fire in sagebrush-grass and pinyon-juniper plant communities: A state-of-the-art review. Ogden, UT: U.S. Department of Agriculture, Forest Service, Intermountain Forest and Range Experiment Station. Gen. Tech. Rep. INT-58. 48 p.

Young, R.P. 1983. Fire as a vegetation management tool in rangelands of the intermountain region. In: Monsen, S.B. and N. Shaw (compilers). Managing intermountain rangelands - improvement of range and wildlife habitats: Proceedings; 1981 September 15-17; Twin Falls, ID; 1982 June 22-24; Elko, NV. Gen. Tech. Rep. INT-157. Ogden, UT: U.S. Department of Agriculture, Forest Service, Intermountain Forest and Range Experiment Station. p 18-31.

Contributors

RK/GKB

Approval

Kendra Moseley, 4/24/2024

Rangeland health reference sheet

Interpreting Indicators of Rangeland Health is a qualitative assessment protocol used to determine ecosystem condition based on benchmark characteristics described in the Reference Sheet. A suite of 17 (or more) indicators are typically considered in an assessment. The ecological site(s) representative of an assessment location must be known prior to applying the protocol and must be verified based on soils and climate. Current plant community cannot be used to identify the ecological site.

Author(s)/participant(s)	
Contact for lead author	
Date	05/19/2024
Approved by	Kendra Moseley
Approval date	
Composition (Indicators 10 and 12) based on	Annual Production

Indicators

1. Number and extent of rills:

2. Presence of water flow patterns:

3. **Number and height of erosional pedestals or terracettes:**

4. **Bare ground from Ecological Site Description or other studies (rock, litter, lichen, moss, plant canopy are not bare ground):**

5. **Number of gullies and erosion associated with gullies:**

6. **Extent of wind scoured, blowouts and/or depositional areas:**

7. **Amount of litter movement (describe size and distance expected to travel):**

8. **Soil surface (top few mm) resistance to erosion (stability values are averages - most sites will show a range of values):**

9. **Soil surface structure and SOM content (include type of structure and A-horizon color and thickness):**

10. **Effect of community phase composition (relative proportion of different functional groups) and spatial distribution on infiltration and runoff:**

11. **Presence and thickness of compaction layer (usually none; describe soil profile features which may be mistaken for compaction on this site):**

12. **Functional/Structural Groups (list in order of descending dominance by above-ground annual-production or live foliar cover using symbols: >>, >, = to indicate much greater than, greater than, and equal to):**

Dominant:

Sub-dominant:

Other:

Additional:

13. **Amount of plant mortality and decadence (include which functional groups are expected to show mortality or decadence):**

14. **Average percent litter cover (%) and depth (in):**

15. **Expected annual annual-production (this is TOTAL above-ground annual-production, not just forage annual-production):**

16. **Potential invasive (including noxious) species (native and non-native). List species which BOTH characterize degraded states and have the potential to become a dominant or co-dominant species on the ecological site if their future establishment and growth is not actively controlled by management interventions. Species that become dominant for only one to several years (e.g., short-term response to drought or wildfire) are not invasive plants. Note that unlike other indicators, we are describing what is NOT expected in the reference state for the ecological site:**

17. **Perennial plant reproductive capability:**
