

## **Ecological site R025XY003NV LOAMY BOTTOM 8-14 P.Z.**

Last updated: 4/24/2024  
 Accessed: 09/21/2024

---

### General information

**Provisional.** A provisional ecological site description has undergone quality control and quality assurance review. It contains a working state and transition model and enough information to identify the ecological site.

### MLRA notes

Major Land Resource Area (MLRA): 025X–Owyhee High Plateau

The Owyhee High Plateau, MLRA 25, lies within the Intermontane Plateaus physiographic province. The southern half is found in the Great Basin while the northern half is located in the Columbia Plateaus. The southern section of the Owyhee High Plateau is characterized by isolated, uplifted fault-block mountain ranges separated by narrow, aggraded desert plains. This geologically older terrain has been dissected by numerous streams draining to the Humboldt River. The northern section forms the southern boundary of the extensive Columbia Plateau basalt flows. Deep, narrow canyons drain to the Snake River across the broad volcanic plain.

This MLRA is characteristically cooler and wetter than the neighboring MLRAs of the Great Basin. Elevation ranges from 3,000 to 7,550 feet (915 to 2,300 meters) on rolling plateaus and in gently sloping basins. It is more than 9,840 feet (3,000 meters) on some steep mountains. The average annual precipitation in most of this area is typically 11 to 22 inches (215 to 1,247 millimeters). It increases to as much as 49 inches (1,245 millimeters) at the higher elevations. Precipitation occurs mainly as snow in winter. The supply of water from precipitation and streamflow is small and unreliable, except along major rivers. Streamflow depends largely on accumulated snow in the mountains.

The dominant soil orders in this MLRA are Aridisols and Mollisols. The soils in the area dominantly have a mesic or frigid temperature regime and an aridic, arid bordering on xeric, or xeric moisture regime. Most of the soils formed in mixed parent material. Volcanic ash and loess mantle the landscape. Surface soil textures are loam and silt loam, and have ashly texture modifiers in some cases. Argillic horizons occur on the more stable landforms.

### Ecological site concept

This ecological site is on run-in landscape positions on inset fans and mountain valley fans. Soils are very deep, well drained and loamy or fine-loamy textured. Soil are characterized by a thick fertile surface horizon (mollic epipedon) and may also have evidence of relic water features. Important abiotic factors contributing to the presence of this site include deep rooting depth and increased available soil moisture resulting from run-in. The Reference State is characterized by a dense stand of tall, cool-season perennial grasses with scattered basin big sagebrush. The plant community is dominated by basin wildrye. Bare ground does not exceed 20 percent.

### Associated sites

R025XY001NV	<b>MOIST FLOODPLAIN</b> Salix and LETR5 dominant plants; seasonal high water table between 15 and 60cm.
R025XY019NV	<b>LOAMY 8-10 P.Z.</b> ARTRW8 dominant plant; soils are well drained.
R024XY006NV	<b>DRY FLOODPLAIN</b> PONE3 and PHAL2 dominant plants; less productive site; seasonal high water table below 50cm.

R025XY005NV	<b>WET MEADOW</b> DECE3 dominant grass and willow minor or absent; less productive site.
-------------	---

### Similar sites

R025XY001NV	<b>MOIST FLOODPLAIN</b> LETR5 and Salix are important species; soils with a seasonal high water table 15-60cm from the soil surface
R025XY006NV	<b>DRY MEADOW</b> PONE3 and PHAL2 dominant plants; less productive site; seasonal high water table below 50cm.
R025XY070NV	<b>LOAMY FAN 8-10 P.Z.</b> Less productive site; soil characterized by an ochric epipedon and accumulation of silica in the subsoil (duric feature)
R025XY062OR	<b>SILTY SWALE 8-11 PZ</b> occurs on stream terraces, soils are well drained, no water table. Occurs in the Dissected low lava plateau land resource unit.
R025XY028ID	<b>LOAMY BOTTOM 12-16</b> occurs on terraces and floodplains of alluvial flats. Soils are moderately well or well drained with a seasonal high water table. Occurs on Dissected High Lava Plateau land resource unit.

**Table 1. Dominant plant species**

Tree	Not specified
Shrub	(1) <i>Artemisia tridentata subsp. tridentata</i>
Herbaceous	(1) <i>Leymus cinereus</i>

### Physiographic features

This ecological site is on inset fans, fan aprons and mountain valley fans in mountains and upper piedmont slopes where run-in moisture can accumulate.

This site may also occur on stream terraces resulting from historical incision by stream channel entrenchment. Slopes range from 2 to 8 percent, but typically less than 4 percent. Elevations range from 4,500 to 7,000 feet (1,372 to 2,133 meters).

Where this site is correlated to soils occurring on the outer margins of axial-stream floodplains and inset fans adjacent to perennial streams it should be considered a drained ecological state of a wet meadow.

**Table 2. Representative physiographic features**

Landforms	(1) Mountains > Mountain valley (2) Fan (3) Piedmont slope > Inset fan (4) Fan apron
Runoff class	Low to medium
Flooding duration	Extremely brief (0.1 to 4 hours)
Flooding frequency	None to very rare
Elevation	1,372–2,134 m
Slope	2–8%
Aspect	Aspect is not a significant factor

### Climatic features

The climate associated with this site is defined by hot dry summers and cold snowy winters. This site is characterized by less than 120 freeze-free days annually. Mean annual precipitation is around 10 inches with an effective precipitation between 8 and 14 inches. Average snowfall is between 30-40 inches per year.

\*The above data is average from the Elko regional airport climate station based on elevation and precipitation. Site specific data should be obtained by accessing the database provided by the Western Regional Climate Center (wrcc.dri.edu).

**Table 3. Representative climatic features**

Frost-free period (characteristic range)	80-100 days
Freeze-free period (characteristic range)	92-148 days
Precipitation total (characteristic range)	203-381 mm
Frost-free period (actual range)	30-156 days
Freeze-free period (actual range)	52-181 days
Precipitation total (actual range)	102-457 mm
Frost-free period (average)	92 days
Freeze-free period (average)	120 days
Precipitation total (average)	305 mm

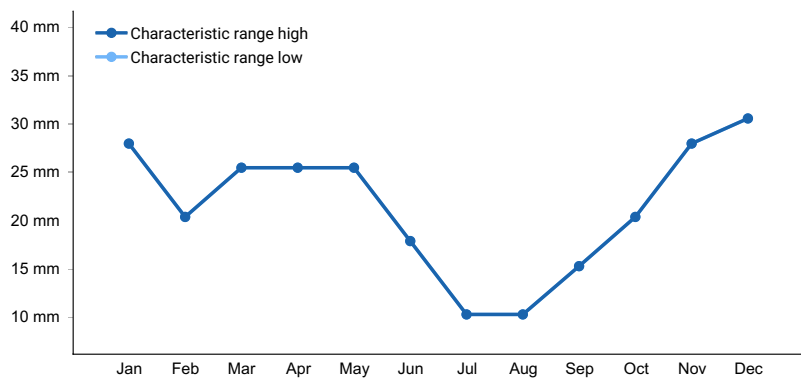

**Figure 1. Monthly precipitation range**

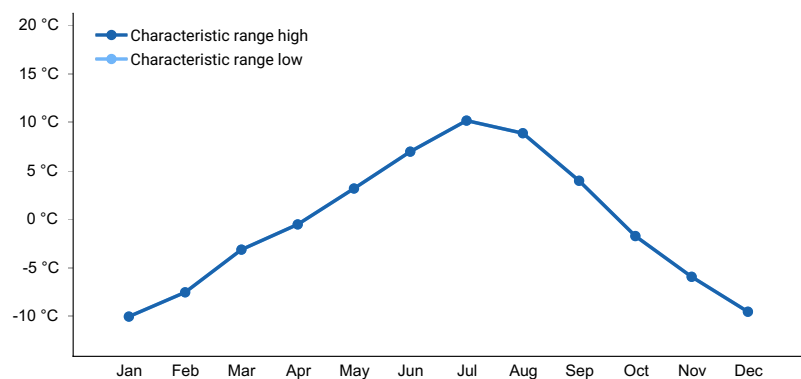

**Figure 2. Monthly minimum temperature range**

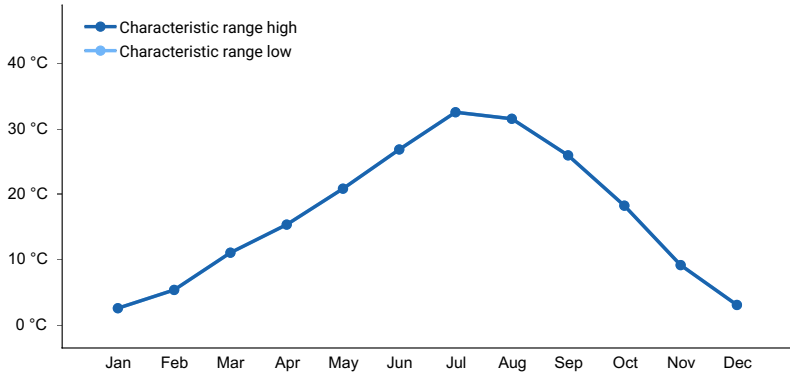

**Figure 3. Monthly maximum temperature range**

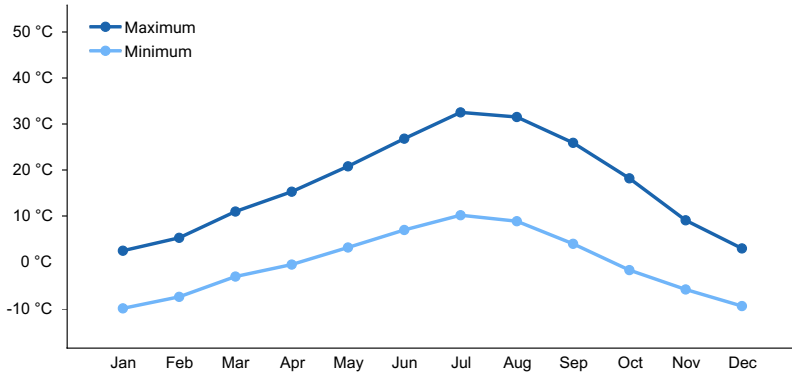

**Figure 4. Monthly average minimum and maximum temperature**

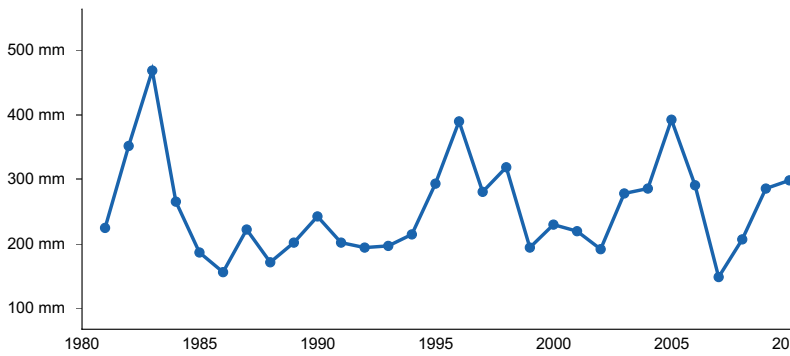

**Figure 5. Annual precipitation pattern**

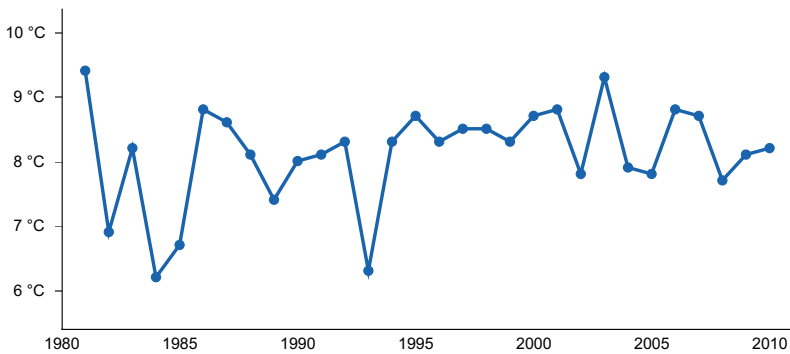

**Figure 6. Annual average temperature pattern**

### Climate stations used

- (1) ELKO RGNL AP [USW00024121], Elko, NV

### Influencing water features

Influencing water features are not associated with this ecological site.

Where this site is associated with perennial streams the soils should be field checked, it may be a degraded ecological state of a wet meadow.

## Wetland description

N/A

## Soil features

Soils associated with this ecological site are very deep, well drained and formed in alluvium derived from volcanic ash and volcanic rocks. Surface soil textures are typically ashy loam, loam or sandy loam. The soil profile is characterized by a thick fertile surface horizon (mollic epipedon) from the soil surface to between 16 and 31 inches (40 and 80cm). The parent material typically has a large amount of vitric pyroclastic material such as volcanic ash. Buried A horizons are common. Some pedons have gravelly strata or strata of ashy silty clay loam, ashy silt loam, clay, ashy loam, ashy very fine sandy loam, or ashy sandy loam.

Representative soil components include Chug and Rodock.

Where these soils exhibit characteristics of historic soil saturation as evidenced by relict redoximorphic features incision by stream channel entrenchment has removed the zone of saturation from these soils as evidenced by depth to current stream that is commonly confined within sheer vertical walls. This historical drainage is not considered artificial (in other words upon removal of disturbances or practices that contributed to drainage, aquic conditions would not return) and does not allow for application of an aquic soil moisture regime to the taxonomic classification of this soil.

Where this site is correlated to somewhat poorly, poorly, or very poorly drained soil series such as Albruz, Bicondoa, Clementine, Crooked Creek, Devilsgait, Four Star, Halleck, Hussa, Kingsriver, Rose Creek, Settlemyer, Sonoma, Tweba, Welch and Xipe components should be field checked and full consideration should be given to including a drained phase on these soil map unit components.

Table 4. Representative soil features

Parent material	(1) Alluvium–volcanic rock
Surface texture	(1) Loam (2) Ashy loam (3) Sandy loam
Family particle size	(1) Fine-loamy
Drainage class	Well drained
Permeability class	Slow to moderately rapid
Soil depth	152–183 cm
Surface fragment cover <=3"	0–5%
Surface fragment cover >3"	0–5%
Available water capacity (0-101.6cm)	15.62–21.08 cm
Soil reaction (1:1 water) (0-101.6cm)	6.6–8.4
Subsurface fragment volume <=3" (Depth not specified)	5–25%
Subsurface fragment volume >3" (Depth not specified)	2–15%

## Ecological dynamics

This ecological site is dominated by deep-rooted cool season perennial bunchgrasses and long-lived shrubs (50+ years) with high root to shoot ratios. These shrubs have a flexible generalized root system with development of both deep taproots and laterals near the surface (Comstock and Ehleringer 1992).

Basin wildrye is weakly rhizomatous and has root depths of up to 80 inches and exhibits greater lateral root spread than many other grass species (Abbott et al. 1991, Reynolds and Fraley 1989). Basin wildrye is a large, cool-season perennial bunchgrass with an extensive and deep fibrous root system (Reynolds and Fraley 1989). Clumps may reach up to 6 feet in height (Ogle et al. 2012). Basin wildrye does not tolerate long periods of inundation; rather, it prefers cycles of wet winters and dry summers and is most commonly found in deep soils with high water holding capacities or seasonally high water tables (Ogle et al 2012, Perryman and Skinner 2007).

This ecological site has moderate resilience to disturbance and resistance to invasion. The introduction of annual species (cheatgrass) may cause an increase in fire frequency and eventually lead to a state change dominated by rabbitbrush. Potential invasive/noxious weeds are rubber rabbitbrush, annual mustards, poverty weed, whitetop, thistle, annual kochia, and pigweed.

In many basin big sagebrush communities, changes in fire frequency occur with fire suppression, livestock grazing and off-highway vehicle (OHV) use. Few, if any, fire history studies have been conducted on basin big sagebrush; however, Sapsis and Kauffman (1991) suggest that fire return intervals in basin big sagebrush are intermediate between mountain big sagebrush (15 to 25 years) and Wyoming big sagebrush (*Artemisia tridentata* ssp. *wyomingensis*) (50 to 100 years). Fire severity in big sagebrush communities is described as "variable" depending on weather, fuels, and topography.

The primary disturbances on this site are channel incision and down cutting cause by soil erosion. This facilitates an increase in shrubs and a decrease in basin wildrye. With continued site degradation, rubber rabbitbrush (*Ericameria nauseosa*) becomes the dominant plant species. There is some evidence that as currently mapped many Loamy Bottom ecological sites are degraded states of Wet Meadow ecological sites created through channel incision processes.

## State and transition model

### Ecosystem states

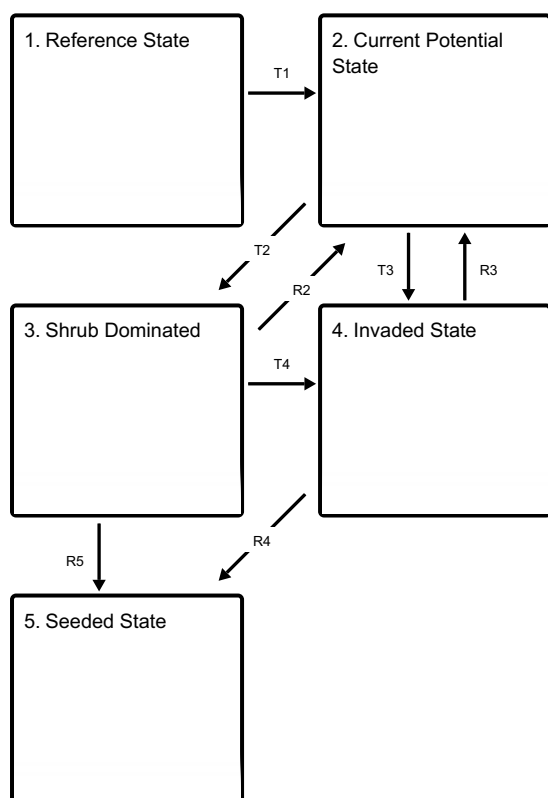

**T1** - introduction of non-natives

**T2** - Hydrologic altering of the site

- T3** - Wide spread and repeated wildfire or soil disturbing practices
- R2** - Brush management and seeding of native perennials.
- T4** - Severe and repeated wildfire and/or failed brush management or seeding
- R5** - Seeding with non-native perennials using minimal soil disturbing practices.
- R3** - Seeding with native species
- R4** - Seeding with non-native perennials using minimal soil disturbing practices.

**State 1 submodel, plant communities**

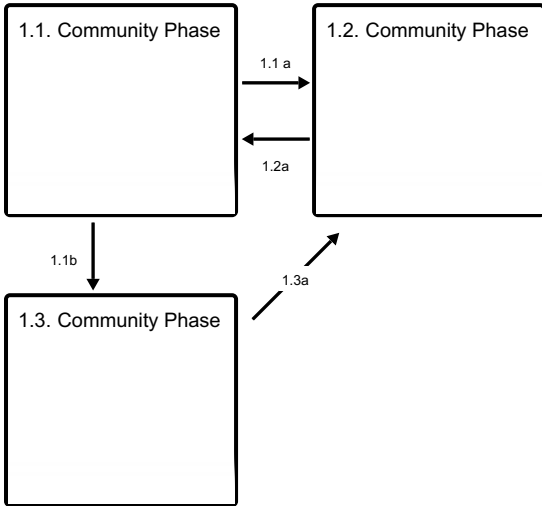

**State 2 submodel, plant communities**

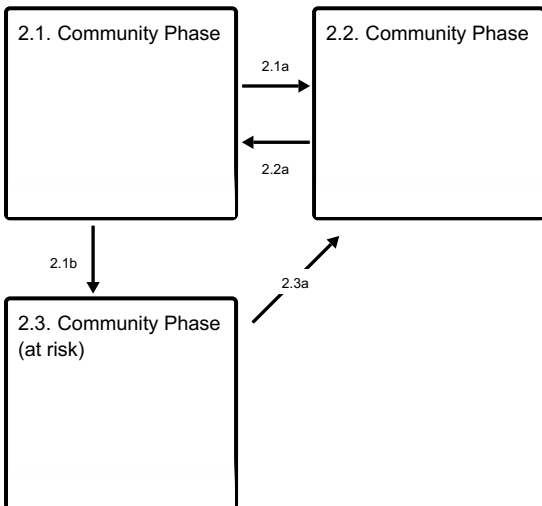

**State 3 submodel, plant communities**

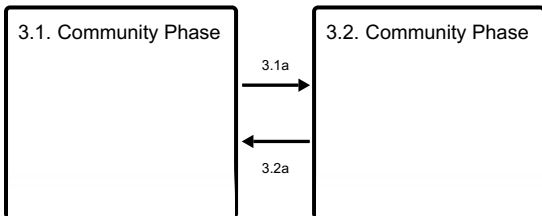

**State 4 submodel, plant communities**

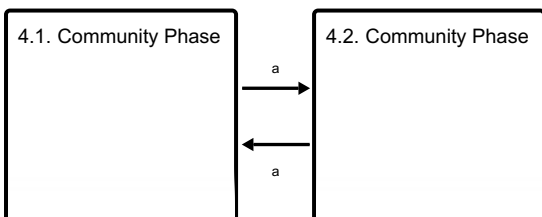

**State 1**

## Reference State

The Reference State is a representative of the natural range of variability under pristine conditions. The Reference State has three general community phases; a shrub-grass dominant phase, a perennial grass dominant phase and a shrub dominant phase. State dynamics are maintained by interactions between climatic patterns and disturbance regimes. Negative feedbacks enhance ecosystem resilience and contribute to the stability of the state. These include the presence of all structural and functional groups, low fine fuel loads, and retention of organic matter and nutrients. Plant community phase changes are primarily driven by fire, periodic drought and/or insect or disease attack.

### Dominant plant species

- basin big sagebrush (*Artemisia tridentata ssp. tridentata*), shrub
- basin wildrye (*Leymus cinereus*), grass

## Community 1.1 Community Phase



Figure 7. Loamy Bottom 10-14" (R028BY003NV), a related site in MLRA 28. Phase 1.1. P. Novak-Echenique June 2012

The representative community phase is characterized by a dense stand of tall, cool-season perennial grasses with scattered basin big sagebrush. The plant community is dominated by basin wildrye. Other important perennial grasses include Nevada bluegrass, streambank wheatgrass, and mat muhly. Potential vegetative composition is approximately 85% grasses, 10% shrubs and 5% forbs. Approximate ground cover (basal and crown) is 45 to 60 percent. Bare ground is approximately 20 percent. Dead branches within individual shrubs are common; standing dead shrub canopy material may be as much as 25% of total woody canopy. Litter cover occurs within plant interspaces at a depth of approximately 1 inch.

Table 5. Annual production by plant type

Plant Type	Low (Kg/Hectare)	Representative Value (Kg/Hectare)	High (Kg/Hectare)
Grass/Grasslike	1905	3335	4287
Shrub/Vine	224	392	504
Forb	112	196	252
<b>Total</b>	<b>2241</b>	<b>3923</b>	<b>5043</b>

Table 6. Ground cover

Tree foliar cover	0-1%
Shrub/vine/liana foliar cover	5-10%
Grass/grasslike foliar cover	35-50%
Forb foliar cover	5-10%



Non-vascular plants	0%
Biological crusts	0%
Litter	30-40%
Surface fragments >0.25" and <=3"	0%
Surface fragments >3"	0%
Bedrock	0%
Water	0%
Bare ground	20-35%

**Table 7. Canopy structure (% cover)**

Height Above Ground (M)	Tree	Shrub/Vine	Grass/ Grasslike	Forb
<0.15	0%	0%	0-5%	0-5%
>0.15 <= 0.3	0%	0%	0-5%	1-5%
>0.3 <= 0.6	0%	0-5%	5-10%	1-5%
>0.6 <= 1.4	0%	5-15%	30-40%	0-1%
>1.4 <= 4	0%	1-5%	0%	0%
>4 <= 12	–	–	–	–
>12 <= 24	–	–	–	–
>24 <= 37	–	–	–	–
>37	–	–	–	–

## Community 1.2 Community Phase

This community phase is characteristic of a post-disturbance, early-seral community. Basin wildrye, Nevada bluegrass and other perennial grasses and grass-like species dominate. Rabbitbrush is present in minor amounts. Depending on fire severity or intensity of Aroga moth infestations, patches of intact sagebrush may remain.

**Resilience management.** Basin big sagebrush does not sprout after fire; due to the length of time needed to produce seed, it is eliminated by frequent fires (Bunting et al. 1987). Basin big sagebrush returns to a site primarily from seeds of plants that survived in unburned patches. Approximately 90% of big sagebrush seed is dispersed within 30 feet (9 m) of the parent shrub (Goodrich et al. 1985) with maximum seed dispersal at approximately 108 feet (33 m) from the parent shrub (Shumar and Anderson 1986). Regeneration of basin big sagebrush after stand replacing fires is therefore both difficult and dependent upon proximity of residual mature plants and favorable moisture conditions (Johnson and Payne 1968, Humphrey 1984). Basin wildrye is relatively resistant to fire as plants sprout from surviving root crowns and rhizomes (Zschaechner 1985). Miller et al. (2013) reported increased shoot densities in the first year following the wildfire with a return to normal shoot production by year two.

## Community 1.3 Community Phase

Sagebrush increases in the absence of disturbance. Decadent sagebrush dominates the overstory and the deep-rooted perennial bunchgrasses in the understory are reduced either from competition with shrubs and/or from herbivory.

## Pathway 1.1 a Community 1.1 to 1.2

Fire significantly reduces sagebrush cover and leads to a early/mid-seral community, dominated by grasses and forbs. Aroga moth infestation may also reduce sagebrush cover resulting in a mosaic of perennial grass and

sagebrush.

### **Pathway 1.1b** **Community 1.1 to 1.3**

Time and lack of disturbance such as fire allows for sagebrush to increase and become decadent. Long term drought, herbivory, or combinations of these will cause a decline in perennial bunchgrasses and fine fuels leading to a reduced fire frequency and allowing big sagebrush to dominate the site.

### **Pathway 1.2a** **Community 1.2 to 1.1**

Time and lack of disturbance will allow sagebrush to increase. Regeneration of sagebrush depends on near by seed source and favorable soil moisture conditions. Completion of this community phase pathway may take a decade or longer.

### **Pathway 1.3a** **Community 1.3 to 1.2**

Fire will decrease or eliminate the overstory of sagebrush and allow for the perennial bunchgrasses to dominate the site. Fire will typically remove most of the sagebrush overstory. A severe infestation of Aroga moth could also cause a large decrease in sagebrush within the community, giving a competitive advantage to the perennial grasses and forbs.

## **State 2** **Current Potential State**

This state is similar to the Reference State 1.0. Ecological function has not changed, however the resiliency of the state has been reduced by the presence of invasive weeds. Non-natives may increase in abundance but will not become dominant within this State. These non-natives can be highly flammable and can promote fire where historically fire had been infrequent. Negative feedbacks enhance ecosystem resilience and contribute to the stability of the state. These feedbacks include the presence of all structural and functional groups, low fine fuel loads, and retention of organic matter and nutrients. Positive feedbacks decrease ecosystem resilience and stability of the state. These include the non-natives' high seed output, persistent seed bank, rapid growth rate, ability to cross pollinate, and adaptations for seed dispersal.

### **Dominant plant species**

- basin big sagebrush (*Artemisia tridentata ssp. tridentata*), shrub
- basin wildrye (*Leymus cinereus*), grass

### **Community 2.1** **Community Phase**

This community phase is similar to the Reference State Community Phase 1.1, with the presence of non-native species in trace amounts. Basin wildrye and Sandberg (Nevada) bluegrass dominate the site. Forbs and other shrubs and grasses make up smaller components of this site.

### **Community 2.2** **Community Phase**



Figure 9. Loamy Bottom 10-14" (R028BY003NV) Phase 2.2 T.K. Stringham, June 2012

This community phase is characteristic of a post-disturbance, early/mid seral community where annual non-native species are present. Perennial bunchgrasses and grass-like species dominate the site. Depending on fire severity or intensity of Aroga moth infestations, patches of intact sagebrush may remain. Rabbitbrush may be sprouting. Non-native species are stable or increasing within the community.

**Resilience management.** Depending on fire severity, rabbitbrush may increase after fire. Rubber rabbitbrush is top-killed by fire, but can rebound after fire (Young 1983). Shortened fire intervals within this ecological site favor a creeping wildrye understory with a rabbitbrush dominated overstory.

### Community 2.3 Community Phase (at risk)



Figure 10. Loamy Bottom 10-14" (R028BY003NV) Phase 2.3 T.K. Stringham, June 2012

This community is at risk of crossing a threshold to another state. Sagebrush dominates the overstory and perennial bunchgrasses in the understory are reduced, either from competition with shrubs, inappropriate grazing, lowered water table or a combination of the three. Rabbitbrush may be a significant component. Beardless wildrye, mat muhly or Sandberg (Nevada) bluegrass may increase and become co-dominant with deep-rooted bunchgrasses. Non-native species may be stable or increasing due to lack of competition with perennial bunchgrasses. This site is susceptible to further degradation from inappropriate grazing, drought, and fire.

### Pathway 2.1a Community 2.1 to 2.2

Fire will decrease or eliminate the sparse stand of sagebrush and perennial bunchgrasses and grass-like species remain dominant on the site. Fire will typically remove most of the sagebrush overstory and rabbitbrush will likely resprout. A severe infestation of Aroga moth could also cause a large decrease in sagebrush giving a competitive advantage

to the perennial grasses and forbs. Non-native species are likely to increase after fire.

**Context dependence.** The effect of fire on bunchgrasses relates to culm density, culm-leaf morphology, and the size of the plant. The initial condition of bunchgrasses within the site, in addition to seasonality and intensity of the fire factor into the individual species' responses. For most forbs and grasses, the growing points are located at or below the soil surface, providing relative protection from disturbances that decrease above-ground biomass, such as grazing or fire. Thus, fire mortality is more correlated to the duration and intensity of the wildfire (Wright 1971, Young 1983). Depending on fire severity, rabbitbrush may increase after fire. Rubber rabbitbrush is top-killed by fire, but can rebound after fire (Young 1983). Shortened fire intervals within this ecological site favor a creeping wildrye understory with a rabbitbrush dominate overstory. Basin wildrye is relatively resistant to fire as plants sprout from surviving root crowns and rhizomes (Zschaechner 1985). Miller et al. (2013) reported increased shoot densities in the first year following the wildfire with a return to normal shoot production by year two.

### **Pathway 2.1b** **Community 2.1 to 2.3**

Time and lack of disturbance such as fire allows for sagebrush and rabbitbrush to increase and become decadent. Long term drought, herbivory, or combinations of these will cause a decline in perennial bunchgrasses and fine fuels leading to a reduced fire frequency and allowing big sagebrush and rabbitbrush to dominate the site. Inappropriate grazing management reduces the perennial bunchgrass understory; conversely beardless wildrye and/or mat muhly may increase in the understory depending on grazing management.

### **Pathway 2.2a** **Community 2.2 to 2.1**

Time and lack of disturbance and/or grazing management that favors the establishment and growth of sagebrush and rabbitbrush allows the shrub component to recover. The establishment of big sagebrush can take many years.

**Context dependence.** Basin big sagebrush returns to a site primarily from seeds of plants that survived in unburned patches. Approximately 90% of big sagebrush seed is dispersed within 30 feet (9 m) of the parent shrub (Goodrich et al. 1985) with maximum seed dispersal at approximately 108 feet (33 m) from the parent shrub (Shumar and Anderson 1986). Regeneration of basin big sagebrush after stand replacing fires is therefore both difficult and dependent upon proximity of residual mature plants and favorable moisture conditions (Johnson and Payne 1968, Humphrey 1984).

### **Pathway 2.3a** **Community 2.3 to 2.2**

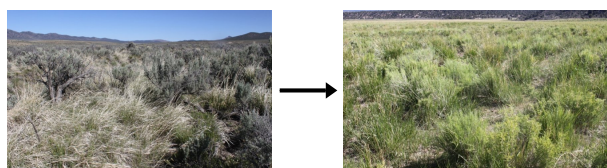

Community Phase (at risk)

Community Phase

Fire will decrease or eliminate the overstory of sagebrush and allow for the perennial bunchgrasses to dominate the site. Fire will typically remove most of the sagebrush overstory. A severe infestation of Aroga moth could also cause a large decrease in sagebrush within the community, giving a competitive advantage to the perennial grasses and forbs. Non-native species respond well to fire and may increase post-burn.

**Context dependence.** The effect of fire on bunchgrasses relates to culm density, culm-leaf morphology, and the size of the plant. The initial condition of bunchgrasses within the site, in addition to seasonality and intensity of the fire factor into the individual species' responses. For most forbs and grasses, the growing points are located at or below the soil surface, providing relative protection from disturbances that decrease above-ground biomass, such as grazing or fire. Thus, fire mortality is more correlated to the duration and intensity of the wildfire (Wright 1971, Young 1983).

## **State 3**

## Shrub Dominated

This state typically results from many years of heavy grazing during time periods harmful to perennial bunchgrasses and/or hydrologic modification resulting in a lowered water table. Basin wildrye is reduced. Creeping wildrye, mat muhly and/or Sandberg bluegrass may become the dominant grass. Sagebrush dominates the overstory and rabbitbrush may be a significant component. Sagebrush may be decadent, reflecting stand maturity. The shrub overstory and creeping wildrye or mat muhly understory dominate site resources such that soil water, nutrient capture, nutrient cycling and soil organic matter are temporally and spatially redistributed.

### Dominant plant species

- basin big sagebrush (*Artemisia tridentata ssp. tridentata*), shrub
- rubber rabbitbrush (*Ericameria nauseosa*), shrub
- thickspike wheatgrass (*Elymus lanceolatus*), grass
- Sandberg bluegrass (*Poa secunda*), grass
- cheatgrass (*Bromus tectorum*), grass

## Community 3.1

### Community Phase



Figure 11. Loamy Bottom 8-14 Phase 3.1 T.K. Stringham, April 2013

Decadent sagebrush dominates the overstory. Rabbitbrush may be a significant component. Deep-rooted perennial bunchgrasses such as basin wildrye may be present in trace amounts, but is not common. Beardless wildrye, mat muhly, and Sandberg bluegrass and annual non-native species increase. Bare ground may increase.

## Community 3.2

### Community Phase

Basin wildrye is absent or minor in this community phase. Creeping wildrye, mat muhly and or Sandberg bluegrass and/or rabbitbrush dominate the site; annual non-native species may be present but are not dominant. Trace amounts of sagebrush may be present.

**Resilience management.** Depending on fire severity, rabbitbrush may increase after fire. Rubber rabbitbrush is top-killed by fire, but can rebound after fire (Young 1983). Shortened fire intervals within this ecological site favor a creeping wildrye understory with a rabbitbrush dominate overstory.

## Pathway 3.1a

### Community 3.1 to 3.2

Fire or heavy fall grazing that causes mechanical damage to shrubs, and/or brush treatments with minimal soil disturbance, will greatly reduce the overstory shrubs to trace amounts and allow for creeping wildrye, mat muhly, or Sandberg bluegrass to dominate the site. Rabbitbrush has a large taproot and is known to be shorter-lived and less competitive than sagebrush. Seedling density, flower production, and shoot growth decline as competition from other species increases (McKell and Chilcote 1957, Miller et al. 2013, Young and Evans 1974).

**Context dependence.** In many basin big sagebrush communities, changes in fire frequency occur with fire suppression, livestock grazing and off-highway vehicle (OHV) use. Fire in basin big sagebrush communities are typically stand-replacing (Sapsis and Kauffman 1991).

### **Pathway 3.2a**

#### **Community 3.2 to 3.1**

Time and lack of disturbance may allow sagebrush to recover.

**Context dependence.** Basin big sagebrush returns to a site primarily from seeds of plants that survived in unburned patches. Approximately 90% of big sagebrush seed is dispersed within 30 feet (9 m) of the parent shrub (Goodrich et al. 1985) with maximum seed dispersal at approximately 108 feet (33 m) from the parent shrub (Shumar and Anderson 1986). Regeneration of basin big sagebrush after stand replacing fires is therefore both difficult and dependent upon proximity of residual mature plants and favorable moisture conditions (Johnson and Payne 1968, Humphrey 1984).

### **State 4**

#### **Invaded State**

This state is characterized by dominance of non-native species. Non-native annuals are most common, but dominance of perennial non-native species, like whitetop (*Lepidium latifolium*) may also occur.

#### **Dominant plant species**

- rubber rabbitbrush (*Ericameria nauseosa*), shrub
- cheatgrass (*Bromus tectorum*), grass

### **Community 4.1**

#### **Community Phase**

Introduced bunchgrass species and other non-native species such as forage kochia (*Bassia prostrata*) dominate the community. Native and non-native seeded forbs may be present. Trace amounts of big sagebrush may be present, especially if seeded. Annual non-native species present.

### **Community 4.2**

#### **Community Phase**

Basin big sagebrush and seeded wheatgrass species co-dominate. Annual non-native species stable to increasing.

### **Pathway a**

#### **Community 4.1 to 4.2**

Inappropriate grazing management particularly during the growing season reduces perennial bunchgrass vigor and density and facilitates shrub establishment.

### **Pathway a**

#### **Community 4.2 to 4.1**

Low severity fire, brush management, and/or Aroga moth infestation will reduce the sagebrush overstory and allow seeded wheatgrass species to become dominant.

### **State 5**

#### **Seeded State**

This state is characterized by the dominance of seeded non-native perennials. Deep-rooted native perennials are reduced or absent.

**Characteristics and indicators.** Site has been seeded with with non-native seeded forage species. Seeding

practices should minimize soil disturbance. Non-native species are stable to increasing within this state.

### **Dominant plant species**

- crested wheatgrass (*Agropyron cristatum*), grass

### **Transition T1**

#### **State 1 to 2**

Trigger: introduction of non-native annual and perennial plants, such as cheatgrass, mustards, and whitetop. Slow variables: Over time the non-native species will increase within the community. Organic matter inputs are reduced. Threshold: Any amount of introduced non-native species causes an immediate decrease in the resilience of the site. Non-native species cannot be easily removed from the system and have the potential to significantly alter disturbance regimes from their historic range of variation.

### **Transition T2**

#### **State 2 to 3**

Trigger: Hydrologic altering of the site (i.e. gulling of associated channel upstream followed by severe soil erosion). Maybe also be coupled with repeated, inappropriate, growing season grazing and prolonged drought. Slow variables: Long term decrease in deep-rooted perennial grass density and increased Sandberg bluegrass favors shrub growth and establishment resulting in reduced organic matter inputs and soil stabilization. Threshold: Loss of deep-rooted perennial bunchgrasses changes nutrient cycling, nutrient redistribution, and organic matter inputs. Alteration in the hydrology of the site caused by soil erosion and gulling reduces soil moisture by increasing runoff and reducing infiltration.

### **Transition T3**

#### **State 2 to 4**

Trigger: Wide spread and repeated wildfire or soil disturbing practices (failed seeding or abandon farmland) coupled with prolonged drought. Slow variables: Increased production and cover of non-native annual species over time. Threshold: Loss of deep-rooted perennial bunchgrasses and shrubs truncates, spatially and temporally, nutrient capture and cycling within the community.

### **Restoration pathway R2**

#### **State 3 to 2**

Brush management such as mowing, coupled with seeding of basin wildrye and other native perennials. This may be coupled with restoration of the water table where channel incision has occurred. Engineered structures may be needed. See USDA, NRCS National Engineering Handbook (2008). This restoration pathway should include prescribed grazing management and minimize soil disturbing practices. A failed restoration attempt may transition the site to an annual dominated state (State 4).

### **Conservation practices**

Brush Management
Range Planting

### **Transition T4**

#### **State 3 to 4**

Trigger: Severe and repeated wildlife and/or failed brush management and seeding, maybe be coupled with prolonged drought. Slow variables: Increased production and cover of non-native annual species over time. Threshold: Loss of deep-rooted perennial bunchgrasses and shrubs truncates, spatially and temporally, nutrient capture and cycling within the community.

### **Restoration pathway R5**

## State 3 to 5

Seeding with non-native perennials using minimal soil disturbing practices. This restoration attempt should be coupled with prescribed grazing management.

## Restoration pathway R3 State 4 to 2

This restoration pathway should include seeding of basin wildrye and other native species coupled with prescribed grazing management. The site may also require restoration of the water table where channel incision has occurred. Engineered structures may be needed. See USDA, NRCS National Engineering Handbook (2008). Probability of success is dependent on adequate soil moisture conditions and care should be taken to minimize soil disturbing practices.

## Restoration pathway R4 State 4 to 5

Seeding with non-native perennials using minimal soil disturbing practices. This restoration attempt should be coupled with prescribed grazing management. Non-native annuals will remain, but will not dominate.

## Additional community tables

Table 8. Community 1.1 plant community composition

Group	Common Name	Symbol	Scientific Name	Annual Production (Kg/Hectare)	Foliar Cover (%)
<b>Grass/Grasslike</b>					
1	<b>Primary Perennial Grasses</b>			2707–3766	
	basin wildrye	LECI4	<i>Leymus cinereus</i>	2354–2746	–
	mat muhly	MURI	<i>Muhlenbergia richardsonis</i>	78–314	–
	thickspike wheatgrass	ELLA3	<i>Elymus lanceolatus</i>	78–314	–
2	<b>Secondary Perennial Grasses</b>			78–314	
	sedge	CAREX	<i>Carex</i>	20–118	–
	squirreltail	ELEL5	<i>Elymus elymoides</i>	20–118	–
	bluebunch wheatgrass	PSSPS	<i>Pseudoroegneria spicata ssp. spicata</i>	20–118	–
<b>Forb</b>					
3	<b>Perennial</b>			196–588	
	povertyweed	IVAX	<i>Iva axillaris</i>	20–118	–
	lupine	LUPIN	<i>Lupinus</i>	20–118	–
	ragwort	SENEC	<i>Senecio</i>	20–118	–
<b>Shrub/Vine</b>					
4	<b>Primary Shrubs</b>			196–392	
	basin big sagebrush	ARTRT	<i>Artemisia tridentata ssp. tridentata</i>	196–392	–
5	<b>Secondary Shrubs</b>			78–314	
	rubber rabbitbrush	ERNA10	<i>Ericameria nauseosa</i>	20–78	–
	currant	RIBES	<i>Ribes</i>	20–78	–
	Woods' rose	ROWO	<i>Rosa woodsii</i>	20–78	–
	willow	SALIX	<i>Salix</i>	20–78	–



## Animal community

### Livestock/Grazing Interpretations:

This site is suitable for cattle and horse grazing during the late fall, winter and early spring. Grazing management considerations include timing, intensity and duration of grazing. Grazing management should focus on basin wildrye and other perennial grass production. Attentive grazing management is required due to the susceptibility of this site to gully erosion. Wetness of the soil in the spring can affect grazing in some areas.

Overgrazing leads to an increase in big sagebrush and a decline in understory plants such as basin wildrye and Nevada bluegrass (*Poa* sp.). Reduced bunchgrass vigor or density provides an opportunity for beardless wildrye (*Leymus triticoides*) or mat muhly (*Muhlenbergia richardsonis*) expansion, as well as cheatgrass and other invasive species to occupy interspaces. Beardless wildrye is tolerant of grazing and increases under grazing pressure (USDA 1937).

If the site is dependent upon a water table supported by an associated stream channel, excessive livestock or wildlife trampling of the streamside vegetation could lead to channel morphology changes and eventual headcutting, incision or other channel instability processes. Any lowering of the water table associated with channel degradation has potential negative impacts on the associated Loamy Bottom plant community. The sagebrush/rabbitbrush component will expand with a lowering of the seasonal water table. The root length of mature sagebrush was measured to a depth of 2m in alluvial soils in Utah (Richards and Caldwell 1987).

During settlement, many of the cattle in the Great Basin were wintered on extensive basin wildrye stands; due to sensitivity to spring, use many stands were decimated by the early 20th century (Young et al. 1976). Less palatable species, such as big sagebrush and rabbitbrush (*Chrysothamnus* spp.), increased in dominance along with invasive non-native species such as Russian thistle, mustards, and cheatgrass (Roundy 1985). The early growth and abundant production of basin wildrye make it a valuable source of forage for livestock. It is important forage for livestock and is readily grazed by cattle and horses in early spring and fall. Though coarse-textured during the winter, basin wildrye may be utilized more frequently by livestock and wildlife when snow has covered low shrubs and other grasses. Basin wildrye is used often as a winter feed for livestock and wildlife by not only providing roughage above the snow but also cover in the early spring months (Majerus 1992). Inadequate rest and recovery from defoliation causes a decrease in basin wildrye and an increase in basin big sagebrush and rubber rabbitbrush (*Ericameria nauseosa*) (Young et al. 1976, Roundy 1985). Spring defoliation of basin wildrye and/or consistent, heavy grazing during the growing season has been found to significantly reduce basin wildrye production and density (Krall et al. 1971). Additionally, native basin wildrye seed viability has been found to be low and seedlings lack vigor (Young and Evans 1981). Roundy (1985) found that although basin wildrye is adapted to seasonally dry saline soils, high and frequent spring precipitation is necessary to establish it from seed. This suggests that establishment of native basin wildrye seedlings occurs only during years of unusually high precipitation; thus, reestablishment of a stand may be episodic.

Nevada bluegrass is very palatable and is preferred by both domestic livestock and wildlife during the spring and early summer, with reported crude protein levels of over 17% (Monson et al. 2004). In today's botanical climate, Nevada bluegrass and Sandberg bluegrass are no longer differentiated taxonomically, however the grasses typically grow in different ecological niches; Nevada bluegrass prefers locations with greater soil moisture during the growing season. Nevada bluegrass exhibits the characteristic of early spring growth, however in locations with sufficient soil moisture the growing season may be extended allowing the plant to increase in stature. Depending on soil moisture availability along with intensity, frequency and season of use, Nevada bluegrass may decrease under grazing pressure. Conversely, Sandberg bluegrass has been found to increase under grazing pressure due to its early dormancy and short stature (Tisdale and Hironaka 1981).

Basin big sagebrush may serve as emergency food during severe winter weather, but it is not usually sought out by livestock.

Stocking rates vary over time depending upon season of use, climate variations, site, and previous and current management goals. A safe starting stocking rate is an estimated stocking rate that is fine-tuned by the client by adaptive management through the year and from year to year.

### Wildlife Interpretations:

Basin wildrye provides winter forage for elk and mule deer, though use is often low compared to other native

grasses. Trace amounts of basin wildrye may be present in the winter diet of bighorn sheep.

Basin wildrye provides summer forage for black-tailed jackrabbits. Because basin wildrye remains green throughout early summer, it remains available for small mammal (vole) forage for a longer time than other grasses and may influence the population dispersion of those small mammals by providing preferred habitat.

In the spring, streambank wheatgrass is a preferred feed for elk and is considered desirable feed for deer and antelope. It is desirable feed for elk during summer, fall, and winter. Streambank wheatgrass is also a component of black-tailed jackrabbit diets. Streambank wheatgrass provides some cover for small mammals and birds. Sedges have a high to moderate resource value for elk and a medium value for mule deer. Elk consume beaked sedge later in the growing season.

## **Hydrological functions**

This site is seasonally flooded from adjacent streams and may also receive run-in moisture from adjacent landscapes. There are no rills or waterflow patterns. There are no erosional pedestals and/or terracettes. Fine litter (foliage of grasses and annual and perennial forbs) is only expected to move during periods of flooding by adjacent streams. Persistent litter (large woody material) will remain in place except during catastrophic flooding events. Deep-rooted, perennial, bunchgrasses slow runoff and increase infiltration. Tall stature and relatively coarse foliage of basin wildrye and associated litter break raindrop impact and provide opportunity for snow catch and snow accumulation on site.

The typical seasonally high water table occurs at depths of 30 to 60 inches, allowing for significant production of basin wildrye. In many areas, this site occurs where a channel has become entrenched, thus lowering the water table required to support a meadow plant community. However, with further channel incision and associated water table lowering, site degradation occurs. Most Great Basin streams have been prone to incision for the past two thousand years, thus separating changes attributable to ongoing stream incision from those caused by human impact can be difficult (Chambers et al. 2004). The most direct evidence that anthropogenic disturbance has attributed to stream incision in the central Great Basin is derived from research on the effects of roads on riparian areas (Forman and Deblinger 2000; Trombulak and Frissel 2000). Assigning cause and effect to more diffuse disturbances such as livestock grazing is more difficult. In general, overuse of the riparian area by livestock can negatively affect stream bank and channel stability, and localized changes in stream morphology have been associated with heavy livestock use in the western United States (see reviews in Trimble and Mendle 1995; Belsky et al. 1999). However, data that clearly demonstrate the relationship between regional stream incision and overuse by livestock have not been collected in the Great Basin (Chambers et al. 2004). The impact of feral horse use on riparian systems is also in need of documentation. In regard to restoration and management, it is important to recognize that particular streams have a greater sensitivity to both natural and management disturbances. For further guidance, see Chambers et al. (2004), Rosgen (2006), or USDA, NRCS Stream Visual Assessment Protocol (1998).

## **Recreational uses**

Aesthetic value is derived from the lush verdure of native grasses in the spring and early summer on this site. This site has potential for deer, antelope and upland game hunting. There is also opportunities for nature study and photography on this site.

## **Wood products**

N/A

## **Other products**

Basin wildrye was used as bedding for various Native American ceremonies, providing a cool place for dancers to stand. Basin big sagebrush bark was used by native Americans for the production of rope and baskets.

## **Other information**

Basin wildrye is useful in mine reclamation, fire rehabilitation and stabilizing disturbed areas. Basin wildrye responds well to irrigation and nitrogen fertilizers. Its usefulness in range seeding is limited by initially weak stand establishment.

Nevada bluegrass can be used in a variety of restoration activities including wildfire rehabilitation and mine reclamation.

Basin big sagebrush shows high potential for range restoration and soil stabilization.

## Inventory data references

Old SS Manuscripts, Range Site Descriptions, etc.

## Type locality

Location 1: Elko County, NV	
Township/Range/Section	T37N R52E S33
General legal description	Approximately 25 miles north of Carlin, Elko County, Nevada. This site also occurs in Eureka, Lander, and Humboldt counties, Nevada.

## Other references

Abbott, M. L., L. Fraley Jr., and T. D. Reynolds. 1991. Root profiles of selected cold desert shrubs and grasses in disturbed and undisturbed soils. *Environmental and Experimental Botany* 31(2): 165-178.

Belsky, A.J., A. Matzke, and S. Uselman. 1999. Survey of livestock influences on stream and riparian ecosystems in the western United States. *J. of Soil and Water Conservation* 54: 419-431.

Bunting, S. C., B. M. Kilgore, and C. L. Bushey. 1987. Guidelines for prescribed burning sagebrush-grass rangelands in the northern Great Basin. US Department of Agriculture, Forest Service, Intermountain Research Station Ogden, UT, USA.

Caudle, D., J. DiBenedetto, M. Karl, H. Sanchez, and C. Talbot. 2013. Interagency Ecological Site Handbook for Rangelands. Available at: <http://jornada.nmsu.edu/sites/jornada.nmsu.edu/files/InteragencyEcolSiteHandbook.pdf>. Accessed 4 October 2013.

Chambers, J.C., J.R. Miller, D. Germanoski, and D.A. Weixelman. 2004. Process-based approaches for managing and restoring riparian ecosystems. In: *Great Basin Riparian Ecosystems*, Island Press, Washington, DC. Chp. 9. pp 261-292.

Chambers, J.C., B.A. Roundy, R.R. Blank, S.E. Meyer, and A. Whittaker. 2007. What makes Great Basin sagebrush ecosystems invasible by *Bromus tectorum*? *Ecological Monographs* 77: 117-145.

Chambers, J. C., B. A. Bradley, C. S. Brown, C. D'Antonio, M. J. Germino, J. B. Grace, S. P. Hardegree, R. F. Miller, and D. A. Pyke. 2013. Resilience to stress and disturbance, and resistance to *Bromus tectorum* L. invasion in cold desert shrublands of western North America. *Ecosystems* 17: 1-16.

Comstock, J.P. and J.R. Ehleringer. 1992. Plant adaptation in the Great Basin and Colorado Plateau. *The Great Basin Naturalist* 52: 195-215.

Daubenmire, R. 1970. *Steppe vegetation of Washington*. 131 pp.

Daubenmire, R. 1975. Plant succession on abandoned fields, and fire influences in a steppe area in southeastern Washington. *Northwest Science* 49: 36-48.

Dobkin, D. S. and J. D. Sauder. 2004. Shrubsteppe landscapes in jeopardy: Distributions, abundances, and the uncertain future of birds and small mammals in the intermountain west. High Desert Ecological Research Institute.

Fire Effects Information System [Online]: <http://www.fs.fed.us/database/feis/>

Ganskopp, D., L. Aguilera, and M. Vavra. 2007. Livestock forage conditioning among six northern Great Basin grasses. *Rangeland Ecology & Management* 60: 71-78.

- Goodrich, S., E. D. McArthur, and A. H. Winward. 1985. A new combination and a new variety in *Artemisia tridentata*. *The Great Basin Naturalist* 45: 99-104.
- Houghton, J.G., C.M. Sakamoto, and R.O. Gifford. 1975. Nevada's weather and climate, special publication 2. Nevada Bureau of Mines and Geology, Mackay School of Mines, University of Nevada, Reno, NV.
- Humphrey, L. D. 1984. Patterns and mechanisms of plant succession after fire on *Artemisia*-grass sites in southeastern Idaho. *Vegetatio* 57: 91-101.
- Johanson, J. K. 2011. An evaluation of state-and-transition model development for ecological sites in northern Utah. Graduate theses and dissertations. Paper 920. <http://digitalcommons.usu.edu/etd/920>
- Johnson, J. R. and G. F. Payne. 1968. Sagebrush reinvasion as affected by some environmental influences. *Journal of Range Management* 21: 209-213.
- Krall, J. L., J. R. Stroh, C. S. Cooper, and S. R. Chapman. 1971. Effect of time and extent of harvesting basin wildfire. *Journal of Range Management* 24: 414-418.
- Lossing, S. 2012. Singleleaf pinyon and Utah juniper canopy interception and understory characteristics in central Nevada. Unpublished M.S. Thesis. Univ. of Idaho. pp.65
- Majerus, M. E. 1992. High-stature grasses for winter grazing. *Journal of Soil and Water Conservation* 47: 224-225.
- McKell, C. M. and W. W. Chilcote. 1957. Response of rabbitbrush following removal of competing vegetation. *Journal of Range Management Archives* 10: 228-229.
- Miller, R. F. C., Jeanne C.; Pyke, David A.; Pierson, Fred B.; Williams, C. Jason 2013. A review of fire effects on vegetation and soils in the Great Basin region: Response and ecological site characteristics. Gen. Tech. Rep. RMRS-GTR-308. Fort Collins CO: U.S. Department of Agriculture, United State Forest Service, Rocky Mountain Research Station. p. 126.
- National Oceanic and Atmospheric Administration. 2004. The North American Monsoon. Reports to the Nation. National Weather Service, Climate Prediction Center. Available online: <http://www.weather.gov/>
- Richards, J.H. and M.M. Caldwell. 1987. Hydraulic lift: substantial nocturnal water transport between layers by *Artemisia tridentata* roots. *Oecologia* 73: 486-489.
- Robberecht, R. and G. Defossé. 1995. The relative sensitivity of two bunchgrass species to fire. *International Journal of Wildland Fire* 5: 127-134.
- Rosgen D. 2006. Watershed assessment of river stability and sediment supply. *Wildland Hydrology*. Fort Collins, CO.
- Sapsis, D. B. and J. B. Kauffman. 1991. Fuel consumption and fire behavior associated with prescribed fires in sagebrush ecosystems. *Northwest Science* 65: 173-179.
- Shumar, M. L. and J. E. Anderson. 1986. Water relations of two subspecies of big sagebrush on sand dunes in southeastern Idaho. *Northwest Science* 60: 179-185.
- Snyder, K.A., T.K. Stringham, J. Huntington, R. Carroll, A.C. Dittrich and M. Weltz. 2013. Porter canyon experimental watershed: Quantifying the effects of pinyon and juniper control on ecosystems processes. Poster presented at Great Basin Landscape Coalition Conference, Reno NV.
- Tisdale, E. W. and M. Hironaka. 1981. The sagebrush-grass region: A review of the ecological literature. University of Idaho, Forest, Wildlife and Range Experiment Station.
- Trimble, S.W. and A.C. Mendel. 1995. The cow as a geomorphic agent: A critical review. *Geomorphology* 13:233-

USDA-Natural Resources Conservation Service. 2008. National Engineering Handbook. Washington D.C.

USDA-NRCS Plants Database (Online; <http://www.plants.usda.gov>).

USDA - Natural Resources Conservation Service. 1998. Stream Visual Assessment Protocol. Technical Note 99-1. National Water and Climate Center. Portland, OR. 36pp.

USDA, Forest Service. 1937. Range Plant Handbook. Dover Publications, Inc., New York, NY. p. 816

Wright, H. A. 1971. Why squirreltail is more tolerant to burning than needle-and-thread. *Journal of Range Management* 24:277-284.

Young, J.A.; Evans, R.A. 1974. Population dynamics of green rabbitbrush in disturbed big sagebrush communities. *Journal of Range Management* 27:127-132.

Young, R. P. 1983. Fire as a vegetation management tool in rangelands of the intermountain region. Pages 18-31 In S. B. Monsen, N. Shaw [eds.] *Managing intermountain rangelands - Improvement of range and wildlife habitats: Proceedings. Rep. INT-GTR-157*. U.S. Department of Agriculture, Forest Service, Intermountain Forest and Range Experiment Station.

Zschaechner, G. A. 1985. Studying rangeland fire effects: A case study in Nevada. Pages 66-84 In: K. Sanders, J. Durham [eds.] *Rangeland fire effects, a symposium*. Bureau of Land Management, Boise, Idaho.

## Contributors

RK/GKB

T. Stringham

P NovakEchenique

Erin Hourihan

## Approval

Kendra Moseley, 4/24/2024

## Rangeland health reference sheet

Interpreting Indicators of Rangeland Health is a qualitative assessment protocol used to determine ecosystem condition based on benchmark characteristics described in the Reference Sheet. A suite of 17 (or more) indicators are typically considered in an assessment. The ecological site(s) representative of an assessment location must be known prior to applying the protocol and must be verified based on soils and climate. Current plant community cannot be used to identify the ecological site.

Author(s)/participant(s)	GK BRACKLEY
Contact for lead author	State Rangeland Management Specialist
Date	06/22/2006
Approved by	Kendra Moseley
Approval date	
Composition (Indicators 10 and 12) based on	Annual Production

## Indicators

1. **Number and extent of rills:** None

---
2. **Presence of water flow patterns:** Flow paths may occur after spring flooding events. Flow paths would be short (<3m), meandering and not connected.

---
3. **Number and height of erosional pedestals or terracettes:** A few plants may be pedestals that occur in flow paths.

---
4. **Bare ground from Ecological Site Description or other studies (rock, litter, lichen, moss, plant canopy are not bare ground):** Bare Ground  $\pm$  20%; surface rock fragments less than 5%; shrub canopy less than 10%; foliar cover of perennial herbaceous plants >60%.

---
5. **Number of gullies and erosion associated with gullies:** None

---
6. **Extent of wind scoured, blowouts and/or depositional areas:** None

---
7. **Amount of litter movement (describe size and distance expected to travel):** Fine litter (foliage of grasses and annual & perennial forbs) only expected to move during periods of flooding by adjacent streams. Persistent litter (large woody material) will remain in place except during large flooding events.

---
8. **Soil surface (top few mm) resistance to erosion (stability values are averages - most sites will show a range of values):** Soil stability values will range from 4 to 6.

---
9. **Soil surface structure and SOM content (include type of structure and A-horizon color and thickness):** Soil surface structure is platy, subangular blocky or granular. Soil surface colors are very dark and the soils have thick mollic epipedons. Organic matter can range from 2 to 3 percent for much of the upper 20 inches.

---
10. **Effect of community phase composition (relative proportion of different functional groups) and spatial distribution on infiltration and runoff:** Deep-rooted, perennial, bunchgrasses slow runoff and increase infiltration. Tall stature and relatively coarse foliage of basin wildrye and associated litter break raindrop impact and provide opportunity for snow catch and snow accumulation on site.

---
11. **Presence and thickness of compaction layer (usually none; describe soil profile features which may be mistaken for compaction on this site):** None - Platy subsurface layers are not to be interpreted as compaction.

---
12. **Functional/Structural Groups (list in order of descending dominance by above-ground annual-production or live foliar cover using symbols: >>, >, = to indicate much greater than, greater than, and equal to):**

Dominant: Reference State: Tall-statured, deep-rooted, cool season, perennial bunchgrasses >> relatively short-statured, deep-rooted, cool season, perennial bunchgrasses >>

Sub-dominant: Deep-rooted, cool season, perennial forbs = rhizomatous, cool season, perennial grasses > tall shrubs > shallow-rooted, cool season, perennial grasses and grass-like plants > fibrous, shallow-rooted, cool season, annual and perennial forbs. (By above ground production)

Other: evergreen and deciduous shrubs

Additional: With an extended fire return interval, shrub functional/structural groups will increase and a corresponding reduction in herbaceous structural/functional groups.

---

13. **Amount of plant mortality and decadence (include which functional groups are expected to show mortality or decadence):** Dead branches within individual shrubs are common; standing dead shrub canopy material may be as much as 25% of total woody canopy.
- 

14. **Average percent litter cover (%) and depth ( in):** Between plant interspaces ( $\pm 80\%$ ) and litter depth is  $\pm 1$  inch.
- 

15. **Expected annual annual-production (this is TOTAL above-ground annual-production, not just forage annual-production):** For normal or average growing season (through June)  $\pm 3500$  lbs/ac; Winter moisture significantly affects total production. Favorable years  $\pm 4500$  lbs/ac and unfavorable years  $\pm 2000$  lbs/ac.
- 

16. **Potential invasive (including noxious) species (native and non-native). List species which BOTH characterize degraded states and have the potential to become a dominant or co-dominant species on the ecological site if their future establishment and growth is not actively controlled by management interventions. Species that become dominant for only one to several years (e.g., short-term response to drought or wildfire) are not invasive plants. Note that unlike other indicators, we are describing what is NOT expected in the reference state for the ecological site:** Potential invaders include annual mustards, povertyweed, thistles, saltcedar, annual kochia, pigweed, and tall whitetop.
- 

17. **Perennial plant reproductive capability:** All functional groups should reproduce in most years. Reduced growth and reproduction occur during extreme or extended drought periods.
-