

## Ecological site R025XY062OR SILTY SWALE 8-11 PZ

Last updated: 4/25/2024  
Accessed: 05/20/2024

---

### General information

**Provisional.** A provisional ecological site description has undergone quality control and quality assurance review. It contains a working state and transition model and enough information to identify the ecological site.

### MLRA notes

Major Land Resource Area (MLRA): 025X–Owyhee High Plateau

Major Land Resource Area (MLRA): 025X–Owyhee High Plateau

The Owyhee High Plateau, MLRA 25, lies within the Intermontane Plateaus physiographic province. The southern half is found in the Great Basin while the northern half is located in the Columbia Plateaus. The southern section of the Owyhee High Plateau is characterized by isolated, uplifted fault-block mountain ranges separated by narrow, aggraded desert plains. This geologically older terrain has been dissected by numerous streams draining to the Humboldt River. The northern section forms the southern boundary of the extensive Columbia Plateau basalt flows. Deep, narrow canyons drain to the Snake River across the broad volcanic plain.

This MLRA is characteristically cooler and wetter than the neighboring MLRAs of the Great Basin. Elevation ranges from 3,000 to 7,550 feet (915 to 2,300 meters) on rolling plateaus and in gently sloping basins. It is more than 9,840 feet (3,000 meters) on some steep mountains. The average annual precipitation in most of this area is typically 11 to 22 inches (215 to 1,247 millimeters). It increases to as much as 49 inches (1,245 millimeters) at the higher elevations. Precipitation occurs mainly as snow in winter. The supply of water from precipitation and streamflow is small and unreliable, except along major rivers. Streamflow depends largely on accumulated snow in the mountains.

The dominant soil orders in this MLRA are Aridisols and Mollisols. The soils in the area dominantly have a mesic or frigid temperature regime and an aridic, arid bordering on xeric, or xeric moisture regime. Most of the soils formed in mixed parent material. Volcanic ash and loess mantle the landscape. Surface soil textures are loam and silt loam, and have ashy texture modifiers in some cases. Argillic horizons occur on the more stable landforms.

### Ecological site concept

This ecological site is on swales and stream terraces of ephemeral streams. Slopes are less than 6 percent. Soils at this site are typically very deep, well drained and formed in volcanic ash and loess over mixed alluvium. The soil profile typically has a dark surface horizon (mollic epipedon), a horizon of clay accumulation (argillic horizon), and less than 25 percent rock fragments by volume.

Important abiotic factors contributing to the presence of this site include increased available seasonal soil moisture and the absence of flooding or ponding. The reference plant community is dominated by basin big sagebrush, bluebunch wheatgrass and basin wildrye.

### Associated sites

R025XY014NV	<b>LOAMY 10-12 P.Z.</b> PSSP and ACTH7 dominant grass, occurs on upper fan remnants, soils characterized by a mollic epipedon and a duripan
-------------	--

R025XY012OR	<b>LOAMY 11-13 PZ</b> PSSP and FEID dominant grass, occurs on lava plateaus, soils characterized by a mollic epipedon and greater than 35% clay in the particle size control section
R025XY007OR	<b>SILTY SWALE 11-13 PZ</b> LECI4 and LETR5 dominant grass, occurs on lava plateaus, soil characterized by a seasonal high water table and redoximorphic features 90-135cm

### Similar sites

R025XY003NV	<b>LOAMY BOTTOM 8-14 P.Z.</b> occurs on run-in landscape positions, not associated with perennial streams, no water table. Occurs in the Piedmont Slope land resource unit.
R025XY028ID	<b>LOAMY BOTTOM 12-16</b> occurs on terraces and floodplains of alluvial flats. Soils are moderately well or well drained with a seasonal high water table. Occurs on Dissected High Lava Plateau land resource unit.

**Table 1. Dominant plant species**

Tree	Not specified
Shrub	(1) <i>Artemisia tridentata subsp. tridentata</i>
Herbaceous	(1) <i>Pseudoroegneria spicata subsp. spicata</i> (2) <i>Leymus cinereus</i>

### Physiographic features

This site is on stream terraces of ephemeral streams and in drainages of narrow swale areas. Slopes are less than 6 percent. Elevations range from 4,000 to 4,600 feet (1,219 to 1,402 meters).

**Table 2. Representative physiographic features**

Landforms	(1) Lava plateau > Stream terrace (2) Swale
Runoff class	Medium
Flooding frequency	None
Ponding frequency	None
Elevation	1,219–1,402 m
Slope	0–6%
Water table depth	254 cm
Aspect	Aspect is not a significant factor

### Climatic features

The climate associated with this site is defined by hot dry summers and cold snowy winters.

Mean annual precipitation is 9 inches (23 cm), with the highest rainfall occurring in May 1.4 inches (3.6 cm) and the lowest in August 0.3 inches (0.76 cm). Averages snowfall is around 28 inches (71 cm) per year. Air temperatures average 26 degrees F in January (coldest) and 66 degrees F in July (warmest).

\*The above and below data is averaged from the Danner, Rome ST AP, MC Dermitt 26 N, and Mcdermitt climate stations, National Soil Information System (NASIS) and, the Western Regional Climate Center.

**Table 3. Representative climatic features**

Frost-free period (characteristic range)	70-110 days
--	-------------

Freeze-free period (characteristic range)	75-121 days
Precipitation total (characteristic range)	229-254 mm
Frost-free period (actual range)	60-120 days
Freeze-free period (actual range)	74-128 days
Precipitation total (actual range)	203-279 mm
Frost-free period (average)	54 days
Freeze-free period (average)	99 days
Precipitation total (average)	229 mm

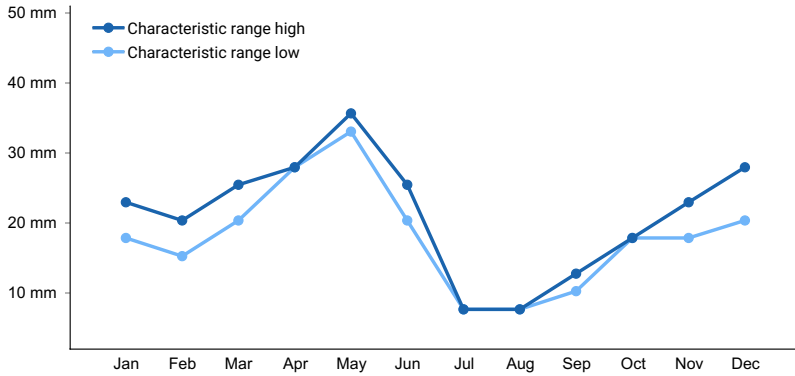

**Figure 1. Monthly precipitation range**

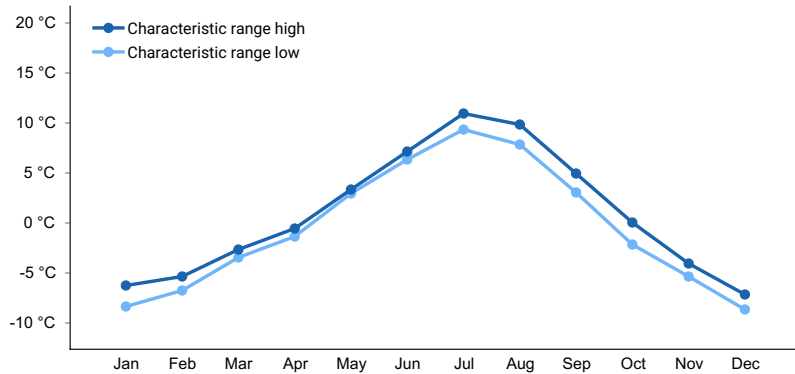

**Figure 2. Monthly minimum temperature range**

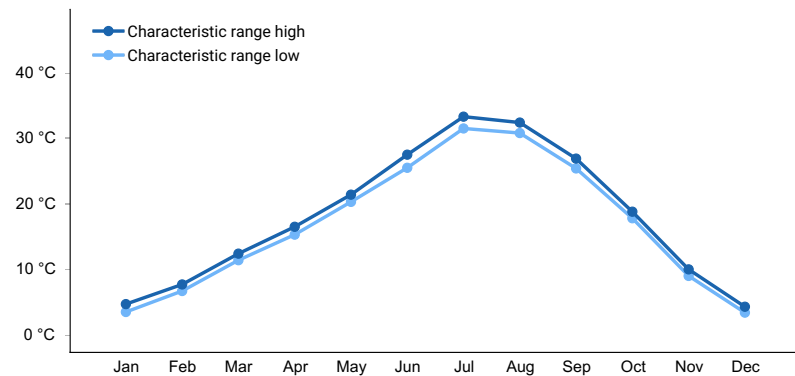

**Figure 3. Monthly maximum temperature range**

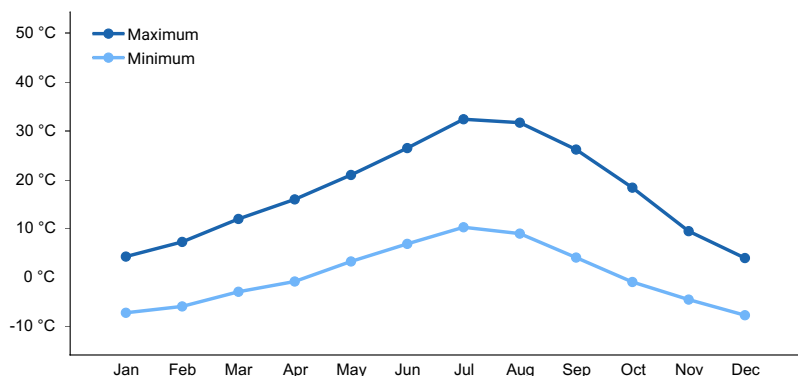

**Figure 4. Monthly average minimum and maximum temperature**

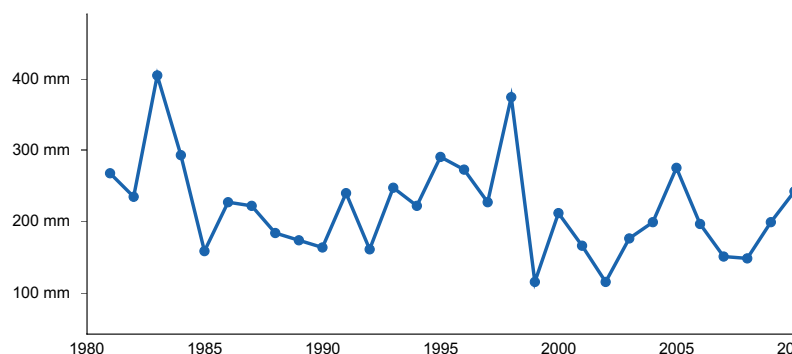

**Figure 5. Annual precipitation pattern**

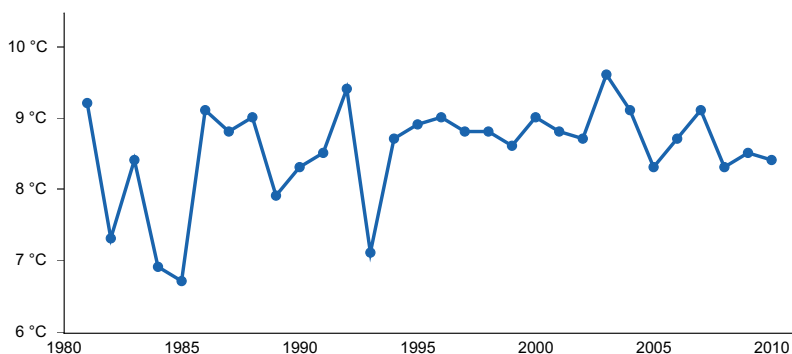

**Figure 6. Annual average temperature pattern**

### Climate stations used

- (1) DANNER [USC00352135], Jordan Valley, OR
- (2) ROME ST AP [USW00094107], Jordan Valley, OR
- (3) MC DERMITT 26 N [USC00355335], Jordan Valley, OR
- (4) MCDERMITT [USC00264935], Jordan Valley, NV

### Influencing water features

Influencing water features are not associated with this ecological site.

Where this site is associated with ephemeral streams the soils may experience brief periods of increased subsurface soil moisture, but this site does not experience endosaturation, flooding, or ponding.

### Wetland description

N/A

### Soil features

Soils associated with this site are very deep, well drained, and formed in volcanic ash and loess over mixed alluvium. The soil profile has a dark surface horizon (mollic epipedon), a horizon of clay accumulation (argillic horizon) from about 5 to 29 inches (12 to 73cm), and less than 25 percent rock fragments by volume. These soils have 20 to 35 percent clay in the particle size control section and some pedons have relict redoximorphic features throughout the soil profile. These redoximorphic features are not an indicator of a present-day water table. They formed under different climatic and geomorphic conditions. Representative soil components include Wisler.

**Table 4. Representative soil features**

Parent material	(1) Alluvium–volcanic rock (2) Volcanic ash (3) Loess
Surface texture	(1) Ashy silt loam
Drainage class	Well drained
Permeability class	Moderate
Depth to restrictive layer	127–178 cm
Soil depth	127–178 cm
Surface fragment cover <=3"	0–3%
Surface fragment cover >3"	0%
Available water capacity (Depth not specified)	12.95–18.8 cm
Soil reaction (1:1 water) (Depth not specified)	6.6–7.8
Subsurface fragment volume <=3" (Depth not specified)	0–5%
Subsurface fragment volume >3" (Depth not specified)	0%

## Ecological dynamics

An ecological site is the product of all the environmental factors responsible for its development and it has a set of key characteristics that influence a site's resilience to disturbance and resistance to invasives. Key characteristics include 1) climate (precipitation, temperature), 2) topography (aspect, slope, elevation, and landform), 3) hydrology (infiltration, runoff), 4) soils (depth, texture, structure, organic matter), 5) plant communities (functional groups, productivity), and 6) natural disturbance regime (fire, herbivory, etc.) (Caudle et al. 2013). Biotic factors that influence resilience include site productivity, species composition and structure, and population regulation and regeneration (Chambers et al. 2013).

This ecological site is dominated by deep-rooted cool season, perennial bunchgrasses and long-lived shrubs (50+ years) with high root to shoot ratios. The dominant shrubs usually root to the full depth of the winter-spring soil moisture recharge, which ranges from 1.0 to over 3.0 m (Dobrowolski et al. 1990). Root length of mature sagebrush plants was measured to a depth of 2 meters in alluvial soils in Utah (Richards and Caldwell 1987). These shrubs have a flexible generalized root system with development of both deep taproots and laterals near the surface (Comstock and Ehleringer 1992).

Bluebunch wheatgrass, a densely tufted native perennial, dominates this site in reference conditions. Maximum rooting depth of bluebunch wheatgrass ranges from 4 to 6 feet. This allows bluebunch to access soil moisture deeper in the soil profile and persist through prolonged drought periods. The subdominant grass with basin wildrye. Basin wildrye does not tolerate long periods of inundation; rather, it prefers cycles of wet winters and dry summers and is most commonly found in deep soils with high water holding capacities or seasonally high water tables (Ogle et al 2012, Perryman and Skinner 2007). Perennial grasses generally have shallower root systems than the shrubs, but root densities are often as high as or higher than those of shrubs in the upper 0.5 m but taper off more rapidly. Differences in root depth distributions between grasses and shrubs result in resource partitioning in these shrub/grass systems.

In many basin big sagebrush communities, changes in fire frequency occur with fire suppression, livestock grazing

and off-highway vehicle (OHV) use. Few, if any, fire history studies have been conducted on basin big sagebrush; however, Sapsis and Kauffman (1991) suggest that fire return intervals in basin big sagebrush are intermediate between mountain big sagebrush (15 to 25 years) and Wyoming big sagebrush (*Artemisia tridentata* ssp. *wyomingensis*) (50 to 100 years). Fire severity in big sagebrush communities is described as "variable" depending on weather, fuels, and topography.

This ecological site has moderately low resilience to disturbance and resistance to invasion. The introduction of annual species (cheatgrass) may cause an increase in fire frequency and eventually lead to the elimination of sagebrush. Other potential invasive species include rubber rabbitbrush, annual mustards, poverty weed, whitetop, thistle, annual kochia, and pigweed.

## State and transition model

### Ecosystem states

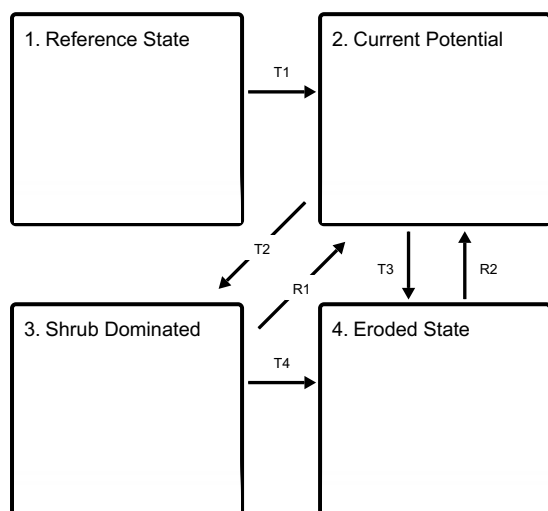

T1 - Introduction of non-natives

T2 - Hydrologic altering of the site

T3 - Wide spread and repeated wildfire or soil disturbing practices

T4 - Severe and repeated wildlife and/or failed restoration attempt

### State 1 submodel, plant communities

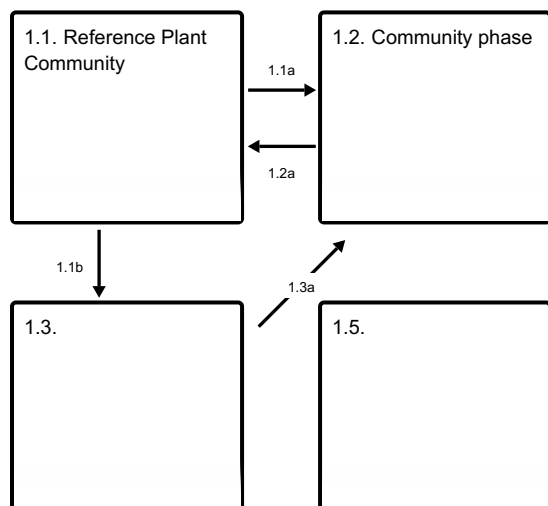

### State 2 submodel, plant communities

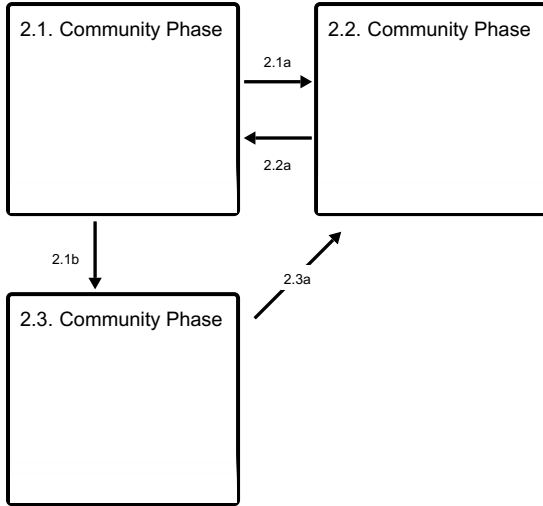

### State 3 submodel, plant communities

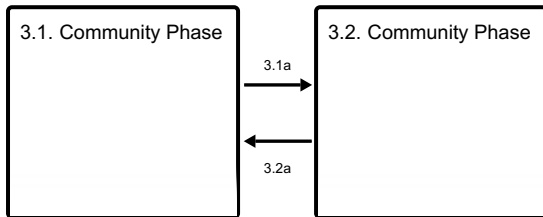

### State 4 submodel, plant communities

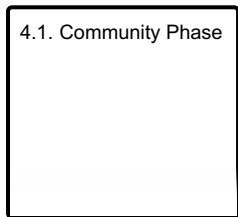

## State 1 Reference State

The Reference State is a representative of the natural range of variability under pre Euro settlement conditions. The Reference State has three general community phases; a shrub-grass dominant phase, a perennial grass dominant phase and a shrub dominant phase. State dynamics are maintained by interactions between climatic patterns and disturbance regimes. Negative feedbacks enhance ecosystem resilience and contribute to the stability of the state. These include the presence of all structural and functional groups, low fine fuel loads, and retention of organic matter and nutrients. Plant community phase changes are primarily driven by fire, periodic drought and/or insect or disease attack.

### Dominant plant species

- basin big sagebrush (*Artemisia tridentata ssp. tridentata*), shrub
- bluebunch wheatgrass (*Pseudoroegneria spicata*), grass
- basin wildrye (*Leymus cinereus*), grass

## Community 1.1 Reference Plant Community

The representative community phase is characterized by a dense stand of tall, cool-season perennial grasses with scattered basin big sagebrush. The plant community is dominated by bluebunch wheatgrass. Other important perennial grasses include basin wildrye and streambank wheatgrass. Potential vegetative composition is approximately 80% grasses, 15% shrubs and 5% forbs. Approximate ground cover (basal and crown) is 55 to 65 percent. Bare ground is approximately 20 percent.

Table 5. Annual production by plant type

Plant Type	Low (Kg/Hectare)	Representative Value (Kg/Hectare)	High (Kg/Hectare)
Grass/Grasslike	807	986	1166
Shrub/Vine	151	185	219
Forb	50	62	73
<b>Total</b>	<b>1008</b>	<b>1233</b>	<b>1458</b>

## Community 1.2

### Community phase

This community phase is characteristic of a post-disturbance, early-seral community. Basin wildrye, Nevada bluegrass and other perennial grasses and grass-likes dominate. Rabbitbrush is present in minor amounts. Depending on fire severity or intensity of Aroga moth infestations, patches of intact sagebrush may remain.

**Resilience management.** Burning bluebunch wheatgrass may remove most of the aboveground biomass but does not usually result in plant mortality. Bluebunch wheatgrass is generally favored by burning and increases post-fire. Basin wildrye is relatively resistant to fire as plants sprout from surviving root crowns and rhizomes (Zschaechner 1985). Miller et al. (2013) reported increased shoot densities in the first year following the wildfire with a return to normal shoot production by year two.

## Community 1.3

Sagebrush increases in the absence of disturbance. Decadent sagebrush dominates the overstory and the deep-rooted perennial bunchgrasses in the understory are reduced either from competition with shrubs and/or from herbivory.

## Community 1.4

### Pathway 1.1a

#### Community 1.1 to 1.2

Fire significantly reduces cover of shrubs and mature bunchgrasses and leads to a early/mid-seral community, dominated by grasses and forbs.

### Pathway 1.1b

#### Community 1.1 to 1.3

Time and lack of disturbance such as fire allows for sagebrush to increase and become decadent. Long term drought, herbivory, or combinations of these will cause a decline in perennial bunchgrasses and fine fuels leading to a reduced fire frequency and allowing big sagebrush to dominate the site.

### Pathway 1.2a

#### Community 1.2 to 1.1

Time and lack of disturbance will allow sagebrush to increase. Regeneration of sagebrush depends on near by seed source and favorable soil moisture conditions. Completion of this community phase pathway may take a decade or longer.

**Context dependence.** Basin big sagebrush returns to a site primarily from seeds of plants that survived in unburned patches. Approximately 90% of big sagebrush seed is dispersed within 30 feet (9 m) of the parent shrub (Goodrich et al. 1985) with maximum seed dispersal at approximately 108 feet (33 m) from the parent shrub (Shumar and Anderson 1986). Regeneration of basin big sagebrush after stand replacing fires is therefore both difficult and dependent upon proximity of residual mature plants and favorable moisture conditions (Johnson and Payne 1968, Humphrey 1984).



### **Pathway 1.3a**

#### **Community 1.3 to 1.2**

Fire will decrease or eliminate the overstory of sagebrush and allow for the perennial bunchgrasses to dominate the site. Fire will typically remove most of the sagebrush overstory. A severe infestation of Aroga moth could also cause a large decrease in sagebrush within the community, giving a competitive advantage to the perennial grasses and forbs.

### **State 2**

#### **Current Potential**

This state is similar to the Reference State 1.0. Ecological function has not changed, however the resiliency of the state has been reduced by the presence of invasive weeds. Non-natives may increase in abundance but will not become dominant within this State. These non-natives can be highly flammable and can promote fire where historically fire had been infrequent. Negative feedbacks enhance ecosystem resilience and contribute to the stability of the state. These feedbacks include the presence of all structural and functional groups, low fine fuel loads, and retention of organic matter and nutrients. Positive feedbacks decrease ecosystem resilience and stability of the state. These include the non-natives' high seed output, persistent seed bank, rapid growth rate, ability to cross pollinate, and adaptations for seed dispersal.

#### **Dominant plant species**

- basin big sagebrush (*Artemisia tridentata* ssp. *tridentata*), shrub
- bluebunch wheatgrass (*Pseudoroegneria spicata*), grass

### **Community 2.1**

#### **Community Phase**

This community phase is similar to the Reference State Community Phase 1.1, with the presence of non-native species in trace amounts. Bluebunch wheatgrass and basin wildrye dominate the site. Forbs and native shrubs and other perennial grasses/grasslikes make up smaller components of this site. Non-natives are present, but do not dominate.

### **Community 2.2**

#### **Community Phase**

This community phase is characteristic of a post-disturbance, early/mid seral community where annual non-native species are present. Perennial bunchgrasses and grass-likes dominate the site and patches of intact sagebrush may remain. Rabbitbrush may be sprouting. Non-native species are stable or increasing within the community.

**Resilience management.** Depending on fire severity, rabbitbrush may increase after fire. Rubber rabbitbrush is top-killed by fire, but can rebound after fire (Young 1983). Shortened fire intervals within this ecological site favor a creeping wildrye understory with a rabbitbrush dominate overstory.

### **Community 2.3**

#### **Community Phase**

This community is at risk of crossing a threshold to another state. Sagebrush dominates the overstory and the perennial bunchgrasses understory is reduced, either from competition with shrubs, inappropriate grazing, lowered water table or a combination of the three. Rabbitbrush may be a significant component. Beardless wildrye or Sandberg bluegrass may increase and become co-dominant with deep-rooted bunchgrasses. Non-native species are stable or increasing due to lack of competition with perennial bunchgrasses. This site is susceptible to further degradation from inappropriate grazing, drought, and repeated wildfire.

### **Pathway 2.1a**

#### **Community 2.1 to 2.2**

Fire will decrease or eliminate the sparse stand of sagebrush and perennial bunchgrasses and grass-likes remain dominant on the site. Fire will typically remove most of the sagebrush overstory and rabbitbrush will likely resprout. A severe infestation of Aroga moth could also reduce sagebrush giving a competitive advantage to perennial grasses and forbs. Non-native species are likely to increase after fire.

**Context dependence.** The effect of fire on bunchgrasses relates to culm density, culm-leaf morphology, and the size of the plant. The initial condition of bunchgrasses within the site, in addition to seasonality and intensity of the fire factor into the individual species' responses. For most forbs and grasses, the growing points are located at or below the soil surface, providing relative protection from disturbances that decrease above-ground biomass, such as grazing or fire. Thus, fire mortality is more correlated to the duration and intensity of the wildfire (Wright 1971, Young 1983). Depending on fire severity, rabbitbrush may increase after fire. Rubber rabbitbrush is top-killed by fire, but can rebound after fire (Young 1983). Shortened fire intervals within this ecological site favor a creeping wildrye understory with a rabbitbrush dominate overstory.

### **Pathway 2.1b** **Community 2.1 to 2.3**

Time and lack of disturbance such as fire allows for sagebrush and rabbitbrush to increase and become decadent. Long term drought, herbivory, or combinations of these will cause a decline in perennial bunchgrasses and fine fuels leading to a reduced fire frequency and allowing big sagebrush and rabbitbrush to dominate the site. Inappropriate grazing management reduces the perennial bunchgrass understory; conversely beardless wildrye and/or bluegrass increase in the understory depending on grazing management.

### **Pathway 2.2a** **Community 2.2 to 2.1**

Time and lack of disturbance and/or grazing management that favors the establishment and growth of sagebrush and rabbitbrush allows the shrub component to recover. The establishment of big sagebrush can take many years.

**Context dependence.** Basin big sagebrush returns to a site primarily from seeds of plants that survived in unburned patches. Approximately 90% of big sagebrush seed is dispersed within 30 feet (9 m) of the parent shrub (Goodrich et al. 1985) with maximum seed dispersal at approximately 108 feet (33 m) from the parent shrub (Shumar and Anderson 1986). Regeneration of basin big sagebrush after stand replacing fires is therefore both difficult and dependent upon proximity of residual mature plants and favorable moisture conditions (Johnson and Payne 1968, Humphrey 1984).

### **Pathway 2.3a** **Community 2.3 to 2.2**

Fire will decrease or eliminate the overstory of sagebrush and allow for the perennial bunchgrasses to dominate the site. Fire will typically remove most of the sagebrush overstory. A severe infestation of Aroga moth could also cause a large decrease in sagebrush within the community, giving a competitive advantage to the perennial grasses and forbs. Non-native species respond well to fire and may increase post-burn.

**Context dependence.** The effect of fire on bunchgrasses relates to culm density, culm-leaf morphology, and the size of the plant. The initial condition of bunchgrasses within the site, in addition to seasonality and intensity of the fire factor into the individual species' responses. For most forbs and grasses, the growing points are located at or below the soil surface, providing relative protection from disturbances that decrease above-ground biomass, such as grazing or fire. Thus, fire mortality is more correlated to the duration and intensity of the wildfire (Wright 1971, Young 1983).

## **State 3** **Shrub Dominated**

This state typically results from many years of heavy grazing during time periods harmful to perennial bunchgrasses and/or hydrologic modification resulting in a lowered water table. Creeping wildrye and/or Sandberg bluegrass increase and may become the dominant grass. Sagebrush dominates the overstory and rabbitbrush may be a

significant component. Sagebrush may be decadent, reflecting stand maturity. The shrub overstory and creeping wildrye or bluegrass understory dominate site resources such that soil water, nutrient capture, nutrient cycling and soil organic matter are temporally and spatially redistributed.

### **Dominant plant species**

- Sandberg bluegrass (*Poa secunda*), grass
- basin big sagebrush (*Artemisia tridentata* ssp. *tridentata*), other herbaceous
- rubber rabbitbrush (*Ericameria nauseosa*), other herbaceous

## **Community 3.1**

### **Community Phase**

Decadent sagebrush dominates the overstory. Rabbitbrush may be a significant component. Deep-rooted perennial bunchgrasses such as bluebunch wheatgrass and basin wildrye may be present in trace amounts, but are not common. Beardless wildrye and Sandberg bluegrass and annual non-native species increase. Bare ground may increase.

## **Community 3.2**

### **Community Phase**

Bluebunch wheatgrass and basin wildrye are absent or minor in this community phase. Creeping wildrye and/or Sandberg bluegrass and rabbitbrush dominate the site; annual non-native species may be present but are not dominant. Trace amounts of sagebrush may be present.

**Resilience management.** Depending on fire severity, rabbitbrush may increase after fire. Rubber rabbitbrush is top-killed by fire, but can rebound after fire (Young 1983). Shortened fire intervals within this ecological site favor a creeping wildrye understory with a rabbitbrush dominated overstory. Rabbitbrush has a large taproot and is known to be shorter-lived and less competitive than sagebrush. Seedling density, flower production, and shoot growth decline as competition from other species increases (McKell and Chilcote 1957, Miller et al. 2013, Young and Evans 1974).

## **Pathway 3.1a**

### **Community 3.1 to 3.2**

Fire or heavy fall grazing that causes mechanical damage to shrubs, and/or brush treatments with minimal soil disturbance, will greatly reduce the overstory shrubs to trace amounts and allow for creeping wildrye, mat muhly, or Sandberg bluegrass to dominate the site.

## **Pathway 3.2a**

### **Community 3.2 to 3.1**

Absence of disturbance and natural regeneration overtime allows sagebrush to recover.

**Context dependence.** Basin big sagebrush returns to a site primarily from seeds of plants that survived in unburned patches. Approximately 90% of big sagebrush seed is dispersed within 30 feet (9 m) of the parent shrub (Goodrich et al. 1985) with maximum seed dispersal at approximately 108 feet (33 m) from the parent shrub (Shumar and Anderson 1986). Regeneration of basin big sagebrush after stand replacing fires is therefore both difficult and dependent upon proximity of residual mature plants and favorable moisture conditions (Johnson and Payne 1968, Humphrey 1984).

## **State 4**

### **Eroded State**

This state is characterized by the loss of deep-rooted native perennials, dominance of non-native species and active soil erosion. Dominance of non-native annuals are most common, but dominance of perennial non-native species, like whitetop (*Lepidium latifolium*) may also occur. Bare ground exceeds site concepts and soil, nutrients and precipitation are redistributed off site. Excessive soil erosion may result in gully development and a significant reduction of soil moisture.

## **Dominant plant species**

- rubber rabbitbrush (*Ericameria nauseosa*), shrub
- cheatgrass (*Bromus tectorum*), grass

## **Community 4.1**

### **Community Phase**

Non-native species dominate the plant community. Bare ground and soil loss is significant. Annual non-native species are common and may dominate. Introduced species such as forage kochia (*Bassia prostrata*) or crested wheatgrass are present, depending on previous restoration attempts. Trace amounts of big sagebrush may be present, especially if seeded. Infiltration has been reduced and run-off has become more rapid.

### **Transition T1**

#### **State 1 to 2**

Trigger: introduction of non-native annual and perennial plants, such as cheatgrass, mustards, and whitetop. Slow variables: Over time the non-native species will increase within the community. Organic matter inputs are reduced. Threshold: Any amount of introduced non-native species causes an immediate decrease in the resilience of the site. Non-native species cannot be easily removed from the system and have the potential to significantly alter disturbance regimes from their historic range of variation.

### **Transition T2**

#### **State 2 to 3**

Trigger: Hydrologic altering of the site (i.e. gulling of associated channel upstream followed by severe soil erosion). Maybe also be coupled with repeated, inappropriate, growing season grazing and prolonged drought. Slow variables: Long term decrease in deep-rooted perennial grass density and increased Sandberg bluegrass favors shrub growth and establishment resulting in reduced organic matter inputs and soil stabilization. Threshold: Loss of deep-rooted perennial bunchgrasses changes nutrient cycling, nutrient redistribution, and organic matter inputs. Alteration in the hydrology of the site caused by soil erosion and gullying reduces soil moisture by increasing runoff and reducing infiltration.

### **Transition T3**

#### **State 2 to 4**

Trigger: Wide spread and repeated wildfire or soil disturbing practices (failed seeding or abandon farmland) coupled with prolonged drought. Slow variables: Increased production and cover of non-native species over time. Threshold: Loss of deep-rooted perennial bunchgrasses and shrubs truncates, spatially and temporally, nutrient, energy, and moisture capture/cycling within the community.

## **Restoration pathway R1**

### **State 3 to 2**

Brush management such as mowing, coupled with seeding of bluebunch wheatgrass and other native perennials. This may be coupled with restoration of the water table where channel incision has occurred. Engineered structures may be needed. See USDA, NRCS National Engineering Handbook (2008). This restoration pathway should include prescribed grazing management and minimize soil disturbing practices. A failed restoration attempt may transition the site to an annual dominated state (State 4).

### **Transition T4**

#### **State 3 to 4**

Trigger: Severe and repeated wildlife and/or failed brush management and seeding, maybe be coupled with prolonged drought. Slow variables: Increased production and cover of non-native annual species over time. Threshold: Loss of deep-rooted perennial bunchgrasses and shrubs truncates, spatially and temporally, nutrient capture and cycling within the community.

## Restoration pathway R2 State 4 to 2

Restoration efforts should include seeding of bluebunch wheatgrass and other native species coupled with prescribed grazing management. The site may also require restoration of the water table where channel incision has occurred. Engineered structures may be needed. See USDA, NRCS National Engineering Handbook (2008). Probability of success is dependent on adequate soil moisture conditions and care should be taken to minimize soil disturbing practices.

### Additional community tables

Table 6. Community 1.1 plant community composition

Group	Common Name	Symbol	Scientific Name	Annual Production (Kg/Hectare)	Foliar Cover (%)
<b>Grass/Grasslike</b>					
1	<b>Dominant, perennial, deep rooted grasses</b>			493–740	
	bluebunch wheatgrass	PSSPS	<i>Pseudoroegneria spicata</i> ssp. <i>spicata</i>	493–740	–
	basin wildrye	LECI4	<i>Leymus cinereus</i>	185–370	–
3	<b>Sub-dominant perennial grasses/grasslikes</b>			73–174	
	Sandberg bluegrass	POSE	<i>Poa secunda</i>	25–74	–
	beardless wildrye	LETR5	<i>Leymus triticoides</i>	12–37	–
	squirreltail	ELEL5	<i>Elymus elymoides</i>	12–25	–
	Idaho fescue	FEID	<i>Festuca idahoensis</i>	12–25	–
	sedge	CAREX	<i>Carex</i>	12–25	–
4	<b>All other perennial grasses</b>			22–78	
	beardless wildrye	LETR5	<i>Leymus triticoides</i>	11–34	–
	sedge	CAREX	<i>Carex</i>	0–22	–
	squirreltail	ELEL5	<i>Elymus elymoides</i>	11–22	–
	Idaho fescue	FEID	<i>Festuca idahoensis</i>	0–22	–
<b>Forb</b>					
5	<b>All perennial forbs</b>			45–90	
	tapertip hawksbeard	CRAC2	<i>Crepis acuminata</i>	11–22	–
	fleabane	ERIGE2	<i>Erigeron</i>	11–22	–
	buckwheat	ERIOG	<i>Eriogonum</i>	11–22	–
	lupine	LUPIN	<i>Lupinus</i>	11–22	–
	phlox	PHLOX	<i>Phlox</i>	0–11	–
	milkvetch	ASTRA	<i>Astragalus</i>	0–11	–
<b>Shrub/Vine</b>					
6	<b>Dominant, shrubs</b>			56–112	
	basin big sagebrush	ARTRT	<i>Artemisia tridentata</i> ssp. <i>tridentata</i>	56–112	–
7	<b>All other shrubs</b>			22–67	
	yellow rabbitbrush	CHVI8	<i>Chrysothamnus viscidiflorus</i>	11–22	–
	rubber rabbitbrush	ERNA10	<i>Ericameria nauseosa</i>	11–22	–
	spiny hopsage	GRSP	<i>Grayia spinosa</i>	11–22	–
	horsebrush	TETRA3	<i>Tetradymia</i>	11–22	–

## **Animal community**

This site offers food and cover for mule deer, antelope, rodents and a variety of birds. It is an important wintering area for mule deer and antelope.

## **Hydrological functions**

The soils are in hydrologic group B. The soils of this site have moderately low runoff potential.

## **Other products**

This site is suited to use by cattle, sheep and horses in late spring, summer and fall under a planned grazing system. Limitations in the spring are saturated, wet soils and unstable banks. Use should be postponed until the soils are firm enough to prevent trampling damage and soil compaction yet, while soil moisture is adequate to allow the completion of the plant growth cycle. Improvement and/or maintenance of bank protecting vegetation should be considered during all seasons, particularly in the fall and winter for spring high flow periods.

## **Other information**

The soils in this site have excellent water holding capacity providing late season water for plant growth and slow water release to streams. When incised channels are present, rehabilitation will markedly improve production and restore good hydrologic characteristics. On altered sites, the reintroduction of desirable plants may be needed to fully restore the site potential.

## **Inventory data references**

Old SS Manuscripts, Range Site Descriptions, etc.

## **References**

- Caudle, D., H. Sanchez, J. DiBenedetto, C. Talbot, and M. Karl. 2013. Interagency Ecological Site Handbook for Rangelands.
- Chambers, J.C., B.A. Bradley, C.S. Brown, C. D'Antonio, M.J. Germino, J.B. Grace, S.P. Hardegree, R.F. Miller, and D.A. Pyke. 2013. Resilience to Stress and Disturbance, and Resistance to *Bromus tectorum* L. Invasion in Cold Desert Shrublands of Western North America. *Ecosystems* 17:360–375.
- Comstock and Ehleringer. 1992. Plant adaptation in the Great Basin and Colorado Plateau. *Great Basin Naturalist*, 1 edition. BYU, Provo, UT.
- Ogle. 2012. Plant Guide for basin wildrye (*Leymus cinereus*). USDA Natural Resource Conservation Service. Aberdeen Plant Materials Center, Aberdeen, ID.
- Perryman and Skinner. 2007. A Field Guide to Nevada Grasses. Indigenous Rangeland Management Press, Lander, WY.
- Sapsis, D.B. and J.B. Kauffman. 1991. Fuel consumption and fire behavior associated with prescribed fires in sagebrush ecosystems. *Northwest Science* 65:173–179.
- Young, J.A. and R.A. Evans. 1974. Population Dynamics of Green Rabbitbrush in Disturbed Big Sagebrush Communities. *Journal of Range Management* 27:127–132.

## Contributors

Bob Gillaspay  
C.D. Tackman  
E. Hourihan

## Approval

Kendra Moseley, 4/25/2024

## Rangeland health reference sheet

Interpreting Indicators of Rangeland Health is a qualitative assessment protocol used to determine ecosystem condition based on benchmark characteristics described in the Reference Sheet. A suite of 17 (or more) indicators are typically considered in an assessment. The ecological site(s) representative of an assessment location must be known prior to applying the protocol and must be verified based on soils and climate. Current plant community cannot be used to identify the ecological site.

Author(s)/participant(s)	
Contact for lead author	
Date	05/20/2024
Approved by	Kendra Moseley
Approval date	
Composition (Indicators 10 and 12) based on	Annual Production

## Indicators

1. **Number and extent of rills:**

---

2. **Presence of water flow patterns:**

---

3. **Number and height of erosional pedestals or terracettes:**

---

4. **Bare ground from Ecological Site Description or other studies (rock, litter, lichen, moss, plant canopy are not bare ground):**

---

5. **Number of gullies and erosion associated with gullies:**

---

6. **Extent of wind scoured, blowouts and/or depositional areas:**

---

7. **Amount of litter movement (describe size and distance expected to travel):**

---

8. **Soil surface (top few mm) resistance to erosion (stability values are averages - most sites will show a range of values):**

---

9. **Soil surface structure and SOM content (include type of structure and A-horizon color and thickness):**

---

10. **Effect of community phase composition (relative proportion of different functional groups) and spatial distribution on infiltration and runoff:**

---

11. **Presence and thickness of compaction layer (usually none; describe soil profile features which may be mistaken for compaction on this site):**

---

12. **Functional/Structural Groups (list in order of descending dominance by above-ground annual-production or live foliar cover using symbols: >>, >, = to indicate much greater than, greater than, and equal to):**

Dominant:

Sub-dominant:

Other:

Additional:

---

13. **Amount of plant mortality and decadence (include which functional groups are expected to show mortality or decadence):**

---

14. **Average percent litter cover (%) and depth ( in):**

---

15. **Expected annual annual-production (this is TOTAL above-ground annual-production, not just forage annual-production):**

---

16. **Potential invasive (including noxious) species (native and non-native). List species which BOTH characterize degraded states and have the potential to become a dominant or co-dominant species on the ecological site if their future establishment and growth is not actively controlled by management interventions. Species that become dominant for only one to several years (e.g., short-term response to drought or wildfire) are not invasive plants. Note that unlike other indicators, we are describing what is NOT expected in the reference state for the ecological site:**

---

17. **Perennial plant reproductive capability:**

---