

## Ecological site R026XF017CA Moist Floodplain

Last updated: 4/10/2024  
Accessed: 05/19/2024

---

### General information

**Provisional.** A provisional ecological site description has undergone quality control and quality assurance review. It contains a working state and transition model and enough information to identify the ecological site.

### MLRA notes

Major Land Resource Area (MLRA): 026X–Carson Basin and Mountains

The area lies within western Nevada and eastern California, with about 69 percent being within Nevada, and 31 percent being within California. Almost all this area is in the Great Basin Section of the Basin and Range Province of the Intermontane Plateaus. Isolated north-south trending mountain ranges are separated by aggraded desert plains. The mountains are uplifted fault blocks with steep side slopes. Most of the valleys are drained by three major rivers flowing east across this MLRA. A narrow strip along the western border of the area is in the Sierra Nevada Section of the Cascade-Sierra Mountains Province of the Pacific Mountain System. The Sierra Nevada Mountains are primarily a large fault block that has been uplifted with a dominant tilt to the west. This structure leaves an impressive wall of mountains directly west of this area. This helps create a rain shadow affect to MLRA 26. Parts of this eastern face, but mostly just the foothills, mark the western boundary of this area. Elevations range from about 3,806 feet (1,160 meters) on the west shore of Pyramid Lake to 11,653 feet (3,552 meters) on the summit of Mount Patterson in the Sweetwater Mountains.

Valley areas are dominantly composed of Quaternary alluvial deposits with Quaternary playa or alluvial flat deposits often occupying the lowest valley bottoms in the internally drained valleys, and river deposited alluvium being dominant in externally drained valleys. Hills and mountains are dominantly Tertiary andesitic flows, breccias, ash flow tuffs, rhyolite tuffs or granodioritic rocks. Quaternary basalt flows are present in lesser amounts, and Jurassic and Triassic limestone and shale, and Precambrian limestone and dolomite are also present in very limited amounts. Also of limited extent are glacial till deposits along the east flank of the Sierra Nevada Mountains, the result of alpine glaciation.

The average annual precipitation in this area is 5 to 36 inches (125 to 915 millimeters), increasing with elevation. Most of the rainfall occurs as high-intensity, convective storms in spring and autumn. Precipitation is mostly snow in winter. Summers are dry. The average annual temperature is 37 to 54 degrees F (3 to 12 degrees C). The freeze-free period averages 115 days and ranges from 40 to 195 days, decreasing in length with elevation.

The dominant soil orders in this MLRA are Aridisols and Mollisols. The soils in the area dominantly have a mesic soil temperature regime, an aridic or xeric soil moisture regime, and mixed or smectitic mineralogy. They generally are well drained, are clayey or loamy and commonly skeletal, and are very shallow to moderately deep.

This area supports shrub-grass vegetation characterized by big sagebrush. Low sagebrush and Lahontan sagebrush occur on some soils. Antelope bitterbrush, squirreltail, desert needlegrass, Thurber needlegrass, and Indian ricegrass are important associated plants. Green ephedra, Sandberg bluegrass, Anderson peachbrush, and several forb species also are common. Juniper-pinyon woodland is typical on mountain slopes. Jeffrey pine, lodgepole pine, white fir, and manzanita grow on the highest mountain slopes. Shadscale is the typical plant in the drier parts of the area. Sedges, rushes, and moisture-loving grasses grow on the wettest parts of the wet flood plains and terraces. Basin wildrye, alkali sacaton, saltgrass, buffaloberry, black greasewood, and rubber rabbitbrush grow on the drier sites that have a high concentration of salts.

Some of the major wildlife species in this area are mule deer, coyote, beaver, muskrat, jackrabbit, cottontail, raptors, pheasant, chukar, blue grouse, mountain quail, and mourning dove. The species of fish in the area include trout and catfish. The Lahontan cutthroat trout in the Truckee River is a threatened and endangered species.

## LRU notes

The Mono-Adobe-Long Valleys LRU is comprised of the basins surrounding Mono Lake, Adobe Valley, and Long Valley to the southeast. Pleistocene and Holocene age alluvium and lacustrine deposits predominate. Ash layers occur from eruptions of the numerous volcanic domes that are mostly in adjacent LRUs. Soil temperature regimes are mesic and soil moisture regimes are aridic. Elevations range from 1310 to 2680 meters and slopes are typically less than 10 percent, however there are some ecological sites within the Mono-Adobe-Long Valleys LRU that are greater than 10 percent. Frost free days (FFD) range from 97-125.

## Ecological site concept

The Moist Floodplain site occurs on broad axial stream terraces along major stream drainages. Elevations are 6000 to 7600 feet. Slopes range from 0 to 2 percent. The soils are very deep and very poorly drained and is not influenced by salt. Surface textures are loams. The subsurface is highly stratified, with textures ranging from sand to clay. Water tables are from 0 to 18 inches from March through May. The soils are also subject to frequent flooding. The plant community is dominated by sedges (*Carex* spp.), rushes (*Juncus* spp.), and Sandberg bluegrass (*Poa secunda*).

## Associated sites

R026XF007CA	<b>Sodic Meadow</b> Site influenced by salts.
-------------	--

## Similar sites

R026XF010CA	<b>Wet Meadow</b> The Wet Meadow site is associated found in bottom locations that do not have streams.
-------------	--

**Table 1. Dominant plant species**

Tree	Not specified
Shrub	Not specified
Herbaceous	(1) <i>Carex</i> (2) <i>Juncus</i>

## Physiographic features

This site occurs on broad axial-stream terraces along major stream channels. Slopes range from 0 to 2 percent.

**Table 2. Representative physiographic features**

Landforms	(1) Stream terrace
Runoff class	Low
Flooding duration	Long (7 to 30 days)
Flooding frequency	Frequent
Elevation	1,829–2,316 m
Slope	0–2%
Water table depth	0–46 cm
Aspect	Aspect is not a significant factor

## Climatic features

The climate on this site is characterized by cold winters (20 to 45 degrees F) and warm, mostly dry summers (40 to 85 degrees F). The average annual precipitation ranges from 9 to 12 inches, with most falling as snow from November to March.

**Table 3. Representative climatic features**

Frost-free period (characteristic range)	
Freeze-free period (characteristic range)	
Precipitation total (characteristic range)	229-305 mm
Frost-free period (average)	108 days
Freeze-free period (average)	135 days
Precipitation total (average)	254 mm

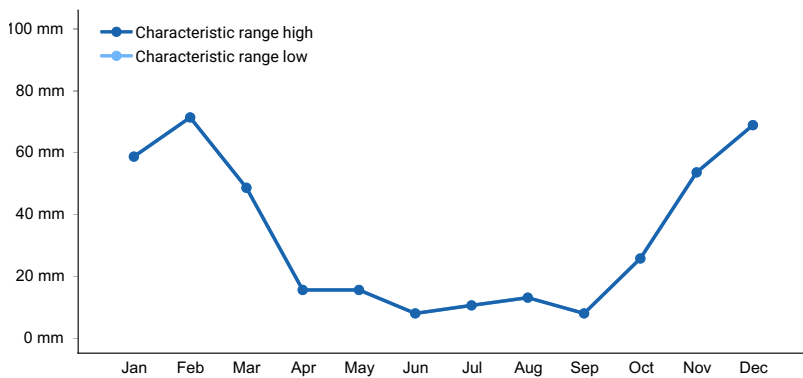

**Figure 1. Monthly precipitation range**

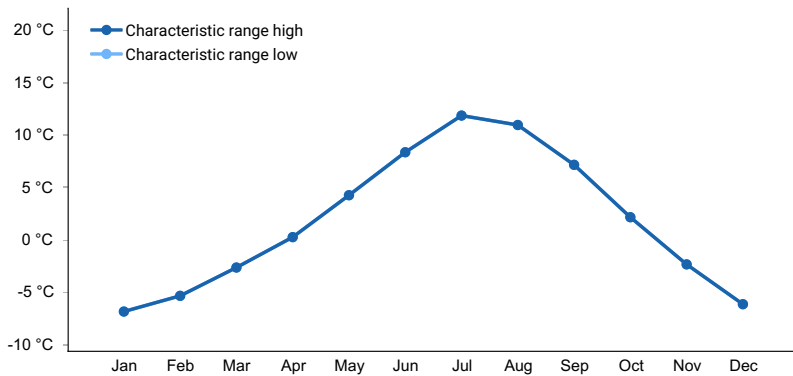

**Figure 2. Monthly minimum temperature range**

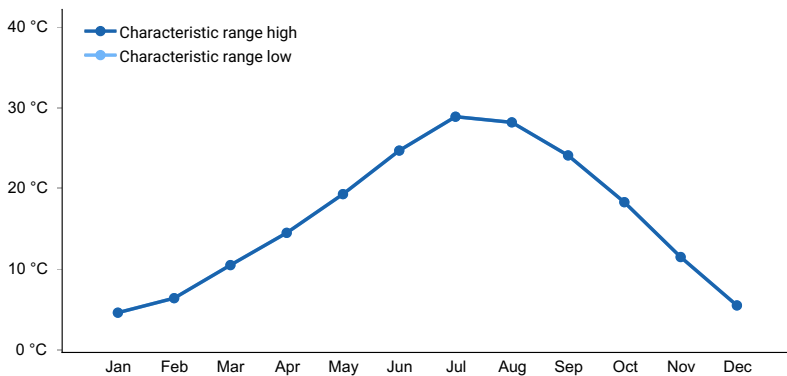

**Figure 3. Monthly maximum temperature range**

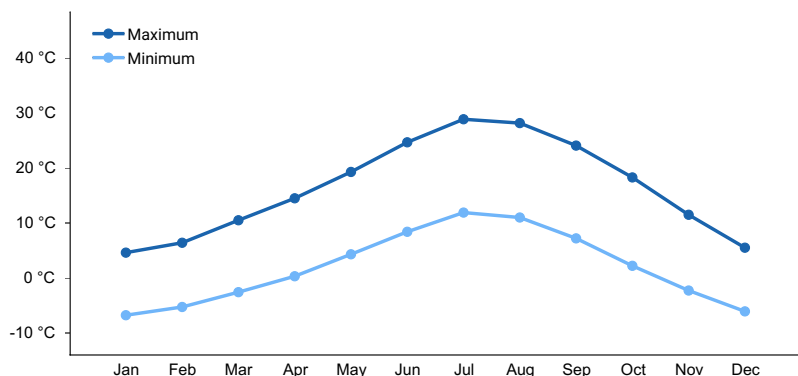

**Figure 4. Monthly average minimum and maximum temperature**

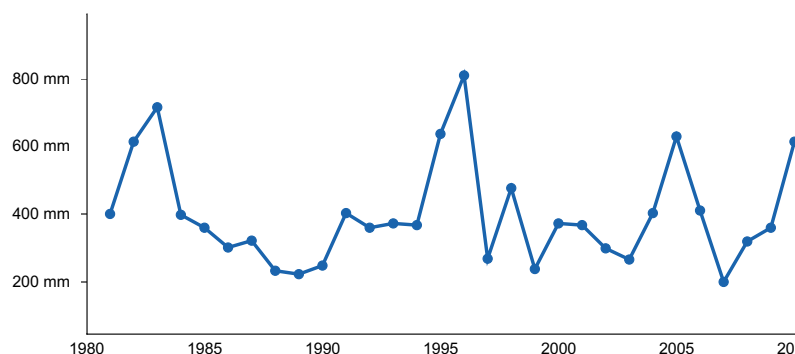

**Figure 5. Annual precipitation pattern**

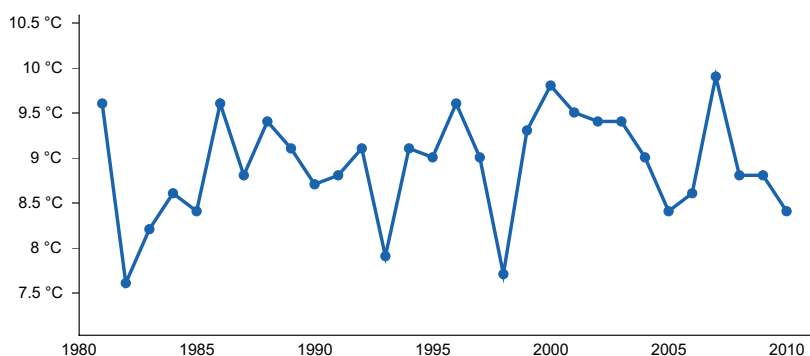

**Figure 6. Annual average temperature pattern**

## Climate stations used

- (1) LEE VINING [USC00044881], Lee Vining, CA

## Influencing water features

The Moist Floodplain site occurs on broad axial stream terraces along major stream drainages. It is frequently flooded.

## Soil features

The soils that characterize this site are very deep and very poorly drained. They formed in alluvium from mixed sources and volcanic ash. Surface textures are loams. The subsurface is highly stratified, with textures ranging from sand to clay. Available water capacity is moderate and the hazard of water erosion is slight. Wind erosion hazard is slight. Effective rooting depth is 60 inches or more. Water tables are from 0 to 18 inches from March through May. The soils are also subject to frequent flooding.

Soil Survey Area: Mapunit symbol:  
CA732: 329bo

**Table 4. Representative soil features**

Parent material	(1) Volcanic ash (2) Alluvium
Surface texture	(1) Loam
Drainage class	Very poorly drained
Permeability class	Moderate
Surface fragment cover <=3"	13%
Surface fragment cover >3"	0%
Available water capacity (Depth not specified)	9.14–11.94 cm
Calcium carbonate equivalent (Depth not specified)	1–5%
Electrical conductivity (Depth not specified)	0 mmhos/cm
Sodium adsorption ratio (Depth not specified)	0
Soil reaction (1:1 water) (Depth not specified)	6.6–7.8
Subsurface fragment volume <=3" (Depth not specified)	13%
Subsurface fragment volume >3" (Depth not specified)	0%

## Ecological dynamics

Stream hydrology influences plant development on this site. Flooding during spring runoff deposits cottonwood seeds on the flood plain where they can germinate and develop given the right soil conditions. Flooding may also scour flood plains and remove young cottonwood seedlings depending on the force of water. Removing water from the streams through irrigation will impact the site hydrology, potentially lowering the water table and reducing flooding. Altering site hydrology to a drier system will change the plant community composition to species adapted to drier soils.

Over use by livestock will cause a decrease in the palatable sedges and rushes, and an increase in thistle and wild iris and the more unpalatable grasses. Species most likely to invade this site include Kentucky bluegrass, redtop, and annual forbs. When soil erosion results in gully formation, mountain big sagebrush and rubber rabbitbrush will invade this site.

## State and transition model

## Ecosystem states

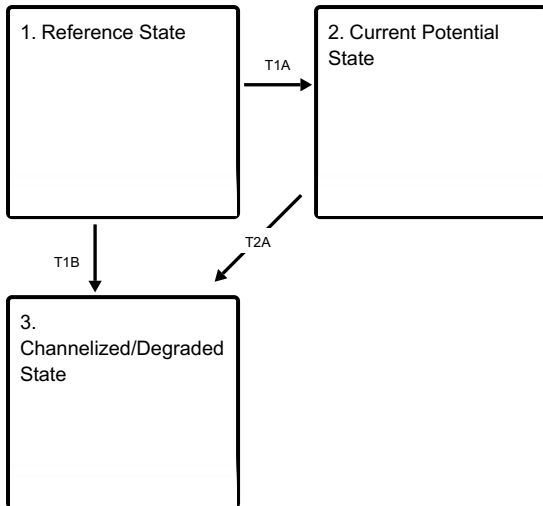

## State 1 submodel, plant communities

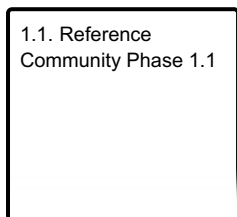

## State 2 submodel, plant communities

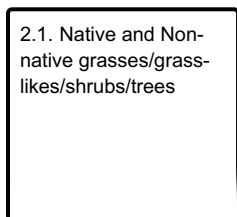

## State 3 submodel, plant communities

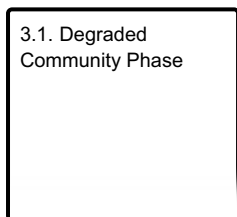

## State 1 Reference State

The Reference State concept has one main community phase. Cottonwood seeds will be left behind after a seasonal flood event. The cottonwood seedlings will germinate if the soil conditions are right (moist and bare). These seedlings, if left undisturbed, will mature to trees. Trees will be sparse and scattered on this site. Rhizomatous willow and graminoids are less influenced by seasonal flooding and may remain intact after seasonal flooding.

## Community 1.1 Reference Community Phase 1.1

The plant community is dominated by sedges, rushes, and Sandberg bluegrass. Potential vegetation composition is about 75% grasses and grass-like plants, 10% forbs, and 15% shrubs and trees.

## Dominant plant species

- willow (*Salix*), tree

- black cottonwood (*Populus balsamifera* ssp. *trichocarpa*), tree
- willow (*Salix*), shrub
- Woods' rose (*Rosa woodsii*), shrub
- sedge (*Carex*), grass
- rush (*Juncus*), grass
- Sandberg bluegrass (*Poa secunda*), grass
- Rocky Mountain iris (*Iris missouriensis*), other herbaceous
- tall ragwort (*Senecio serra*), other herbaceous
- willowherb (*Epilobium*), other herbaceous

## **State 2**

### **Current Potential State**

The Current Potential State occurs after non-native plant species introduction. The species can range from trees, shrubs, to herbaceous. Russian olive, tamarisk, Kentucky bluegrass, and thistles are common non-native plants that can establish on this site.

## **Community 2.1**

### **Native and Non-native grasses/grass-likes/shrubs/trees**

Non-native trees, like Russian olive are present and may dominate the tree canopy. Tamarisk may also occur and take the place of native willows. Kentucky bluegrass is effective at invading wet to semiwet sites and may dominate the understory.

## **State 3**

### **Channelized/Degraded State**

The Channelized/Degraded state is characterized by a adjacent stream that has been channelized or had some other hydrology alteration. Most seasonal floodwaters remain the in channel and do not inundate the flood plain. This reduces cottonwood recruitment and may reduce soil moisture on the site allowing species that are more tolerant to dry conditions to establish.

## **Community 3.1**

### **Degraded Community Phase**

The plant community at this phase may look like a drier ecological site with sagebrush or rabbitbrush. This phase may also be converted to a agricultural field or urban development.

## **Transition T1A**

### **State 1 to 2**

Introduction and establishment of non-native plants. Often concurrent with over use by livestock.

## **Transition T1B**

### **State 1 to 3**

Reduced soil moisture and altered hydrology of the site. Urbanization and agriculture uses may be present.

## **Transition T2A**

### **State 2 to 3**

Reduced soil moisture and altered hydrology of the site. Urbanization and agriculture uses may be present.

## **Additional community tables**

## **Inventory data references**

## Type locality

Location 1: Mono County, CA	
Township/Range/Section	T3S R29E S10
General legal description	Owens River at Benton Crossing Road.

## Contributors

P. Novak

## Approval

Kendra Moseley, 4/10/2024

## Rangeland health reference sheet

Interpreting Indicators of Rangeland Health is a qualitative assessment protocol used to determine ecosystem condition based on benchmark characteristics described in the Reference Sheet. A suite of 17 (or more) indicators are typically considered in an assessment. The ecological site(s) representative of an assessment location must be known prior to applying the protocol and must be verified based on soils and climate. Current plant community cannot be used to identify the ecological site.

Author(s)/participant(s)	
Contact for lead author	
Date	05/19/2024
Approved by	Kendra Moseley
Approval date	
Composition (Indicators 10 and 12) based on	Annual Production

## Indicators

1. **Number and extent of rills:**

---

2. **Presence of water flow patterns:**

---

3. **Number and height of erosional pedestals or terracettes:**

---

4. **Bare ground from Ecological Site Description or other studies (rock, litter, lichen, moss, plant canopy are not bare ground):**

---

5. **Number of gullies and erosion associated with gullies:**

---



6. **Extent of wind scoured, blowouts and/or depositional areas:**

---

7. **Amount of litter movement (describe size and distance expected to travel):**

---

8. **Soil surface (top few mm) resistance to erosion (stability values are averages - most sites will show a range of values):**

---

9. **Soil surface structure and SOM content (include type of structure and A-horizon color and thickness):**

---

10. **Effect of community phase composition (relative proportion of different functional groups) and spatial distribution on infiltration and runoff:**

---

11. **Presence and thickness of compaction layer (usually none; describe soil profile features which may be mistaken for compaction on this site):**

---

12. **Functional/Structural Groups (list in order of descending dominance by above-ground annual-production or live foliar cover using symbols: >>, >, = to indicate much greater than, greater than, and equal to):**

Dominant:

Sub-dominant:

Other:

Additional:

---

13. **Amount of plant mortality and decadence (include which functional groups are expected to show mortality or decadence):**

---

14. **Average percent litter cover (%) and depth ( in):**

---

15. **Expected annual annual-production (this is TOTAL above-ground annual-production, not just forage annual-production):**

---

16. **Potential invasive (including noxious) species (native and non-native). List species which BOTH characterize degraded states and have the potential to become a dominant or co-dominant species on the ecological site if their future establishment and growth is not actively controlled by management interventions. Species that become dominant for only one to several years (e.g., short-term response to drought or wildfire) are not invasive plants. Note that unlike other indicators, we are describing what is NOT expected in the reference state**

for the ecological site:

---

17. **Perennial plant reproductive capability:**

---