

## Ecological site R027XY002NV MOIST FLOODPLAIN

Last updated: 6/03/2024  
Accessed: 06/30/2024

---

### General information

**Provisional.** A provisional ecological site description has undergone quality control and quality assurance review. It contains a working state and transition model and enough information to identify the ecological site.

### MLRA notes

Major Land Resource Area (MLRA): 027X–Fallon-Lovelock Area

#### Physiography

Found in the Great Basin Section of the Basin and Range Province of the Intermontane Plateaus this area is characterized by isolated uplifted fault block mountain ranges trending north to south that are separated by broad, hydrologically closed basins. The entire area occurs in the rain-shadow of the Sierra Nevada mountains and is influenced by Pleistocene Lake Lahontan which reached its most recent high stand about 12,000 years ago. There is substantial evidence suggesting the western Great Basin has been the site of pluvial-interpluvial cycles for at least the past two million years.

The mountains and valleys are dissected by the Humboldt, Truckee, Carson, and Walker Rivers and their tributaries, all of which terminate within MLRA 27. Extensive playas can be found throughout this area and are the result of drying of ancient Lake Lahontan. Elevation generally ranges from 3,300 to 5,900 feet (1,005 to 1,800 meters) in valleys, but on some mountain peaks it is more than 7,870 feet (2,400 meters).

#### Geology

Landforms and soils of this MLRA have been heavily influenced by fluctuating lake level over the last 40,000 years. There is a level line evident on the higher slopes marking the former extent of glacial Lake Lahontan. Almost half of this area has surface deposits of alluvial valley fill influenced by lacustrine sediment. The rest has andesite and basalt rocks of different ages. Mesozoic and Tertiary intrusives are concentrated along the western border of the area, and Lower Volcanic Rocks (17 to 43 million years old) are common on the eastern side of the area. Also, some scattered outcrops of Mesozoic sedimentary and volcanic rocks and tuffaceous sedimentary rocks are in the mountains within the interior of this MLRA.

#### Climate

The average annual precipitation is 5 to 10 inches (125 to 255 millimeters) in most of the area but is as much as 19 inches (485 millimeters) on high mountain slopes. Most of the rainfall occurs as high-intensity, convective thunderstorms during the growing season. The amount of precipitation is very low from summer to midautumn. The precipitation in winter occurs mainly as snow. The average annual temperature is 43 to 54 degrees F (6 to 12 degrees C). The freeze-free period averages 155 days and ranges from 110 to 195 days, decreasing in length with elevation.

#### Water

The amount of precipitation is very low, and water for irrigation is obtained principally from diversions on the four large rivers in the area and from water stored in the Lahontan, Rye Patch, and Weber Reservoirs. Pyramid Lake and Walker Lakes are terminal lakes for the Truckee and Walker Rivers, respectively. Much of the annual flow of both rivers is diverted for irrigation, causing lake levels to fall and levels of dissolved salts to increase causing problems for the native Lahontan cutthroat trout.

#### Soils

The dominant soil orders are Aridisols and Entisols. The soils in the area are predominantly a mesic temperature

regime, aridic moisture regime, and have a mixed mineralogy. They are generally well drained, loamy or sandy, commonly skeletal, and shallow to very deep. Accumulation of salts, tufa deposits, and eolian sediments with soluble salts over lacustrine deposits influence most of the soils in the basin landforms of this MLRA. Soils on bedrock-controlled landforms are typically comprised of volcanic or tuffaceous sedimentary colluvium over residuum.

### Biological Resources

This area supports extensive areas of salt-desert shrub vegetation. Shadscale and Bailey's greasewood are widespread, occurring both individually and together. Grasses are generally sparse, although Indian ricegrass is prominent, especially on the sandy soils. Fourwing saltbush, winterfat, spiny hopsage, wolfberry, ephedra, dalea, and bud sagebrush are common shrubs. Basin wildrye, creeping wildrye, alkali sacaton, saltgrass, black greasewood, rubber rabbitbrush, and big saltbush are important plants on saline bottom lands and terraces. A few marsh areas support cattail, bulrushes, sedges, and rushes. Big sagebrush, along with scattered Utah juniper and singleleaf pinyon, is associated with Thurber needlegrass, desert needlegrass, Sandberg bluegrass, and squirreltail on the higher elevation piedmont slopes and mountains.

### Ecological site concept

The Moist Floodplain site occurs on axial-stream floodplains. Slope gradients are typically less than 2 percent. Elevations are 4000 to 6000 feet. The soils are very deep, fertile and have a high available water capacity. Flooding and a seasonally high water table of 27 to 60 inches of the surface supply additional moisture for plant growth. During the summer and fall months, the water table is at depths below 40 inches.

### Associated sites

F027XY038NV	<b>Flood Plain</b>
R027XY001NV	<b>WETLAND</b>
R027XY005NV	<b>SALINE MEADOW</b>

### Similar sites

R027XY005NV	<b>SALINE MEADOW</b> SPAI dominant grass; SAVE4 dominant shrub
R027XY001NV	<b>WETLAND</b> TYPHA-ELPA3 codominant grasses; soils have a histic epipedon
R027XY004NV	<b>WET MEADOW 8-12 P.Z.</b> PONE3-CAREX codominant grasses; LETR5 minor grass
F027XY038NV	<b>Flood Plain</b> POFR2 dominates visual aspect

Table 1. Dominant plant species

Tree	Not specified
Shrub	(1) <i>Salix</i>
Herbaceous	(1) <i>Leymus triticoides</i> (2) <i>Leymus cinereus</i>

### Physiographic features

The Moist Floodplain site occurs on axial-stream floodplains. Slope gradients of 0 to 2 percent are typical. Elevations are 4000 to 6000 feet.

Table 2. Representative physiographic features

Landforms	(1) Flood plain (2) Stream terrace
Runoff class	Negligible to high
Flooding duration	Very brief (4 to 48 hours) to long (7 to 30 days)
Flooding frequency	Rare to occasional
Ponding frequency	None
Elevation	4,000–6,000 ft
Slope	0–2%
Water table depth	27–60 in
Aspect	Aspect is not a significant factor

## Climatic features

The climate associated with this site is arid, characterized by cool, moist winters and hot, dry summers. Average annual precipitation is 4 to about 8(10) inches. Mean annual air temperature is 45 to 54 degrees F. The average growing season is about 100 to 140 days.

**Table 3. Representative climatic features**

Frost-free period (characteristic range)	95-123 days
Freeze-free period (characteristic range)	118-160 days
Precipitation total (characteristic range)	5-6 in
Frost-free period (actual range)	81-131 days
Freeze-free period (actual range)	103-165 days
Precipitation total (actual range)	5-6 in
Frost-free period (average)	107 days
Freeze-free period (average)	138 days
Precipitation total (average)	5 in

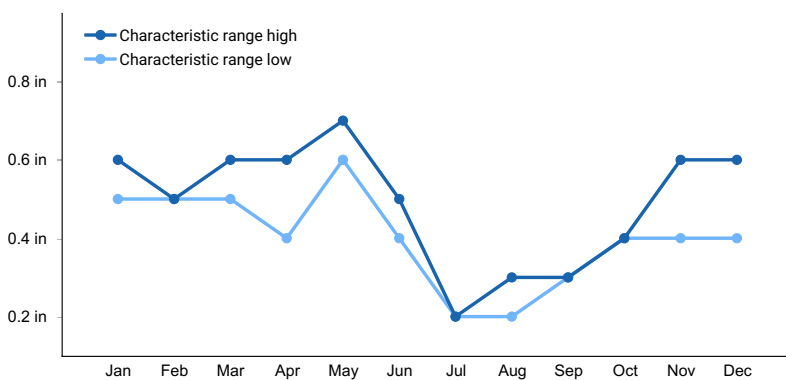

**Figure 1. Monthly precipitation range**

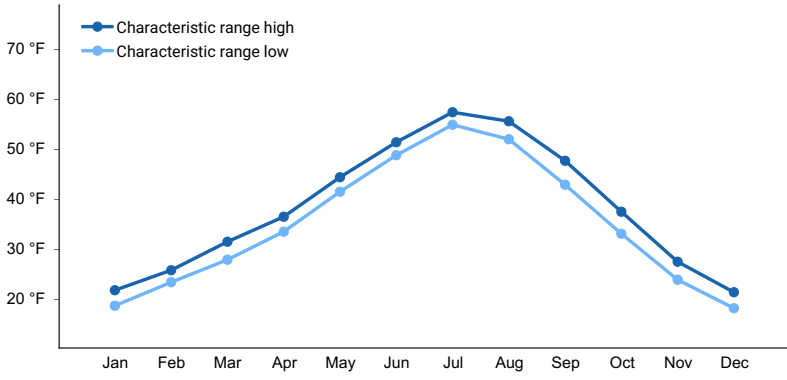

**Figure 2. Monthly minimum temperature range**

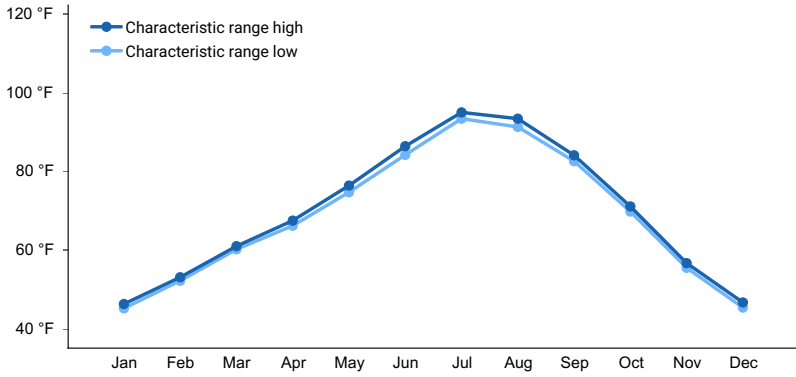

**Figure 3. Monthly maximum temperature range**

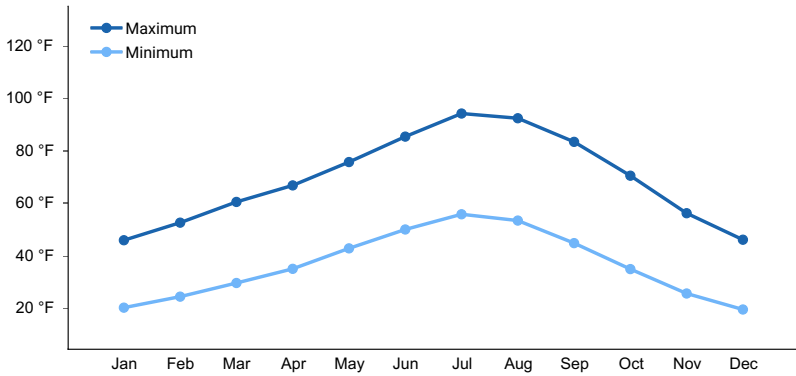

**Figure 4. Monthly average minimum and maximum temperature**

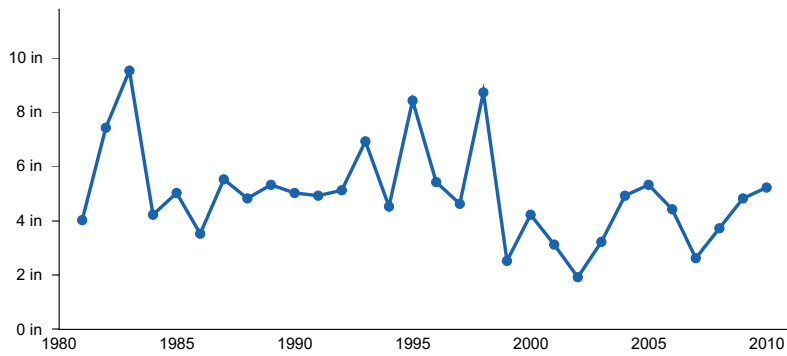

**Figure 5. Annual precipitation pattern**

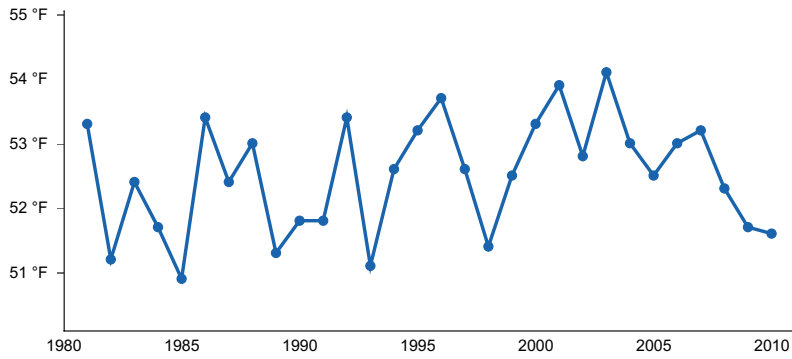

Figure 6. Annual average temperature pattern

### Climate stations used

- (1) YERINGTON [USC00269229], Yerington, NV
- (2) WABUSKA 6 SE [USC00268822], Yerington, NV
- (3) WADSWORTH 4 N [USC00268838], Wadsworth, NV
- (4) FALLON NAAS [USW00093102], Fallon, NV
- (5) FALLON EXP STN [USC00262780], Fallon, NV

### Influencing water features

This site is associated with axial-stream floodplains.

### Soil features

The soils associated with this site are very deep, fertile and have a high available water capacity. These soils are poorly to well drained. Flooding and a seasonally high water table of 27 to 60 inches of the surface supply additional moisture for plant growth. During the summer and fall months, the water table is at depths below 40 inches. Some soils are slightly salt and/or alkali affected. The soils are susceptible to gulying which intercepts normal overflow patterns. The soil series associated with this site include; Dia, Dithod, East fork, Fallon, Fernley, Sagouspe, and Whitmine.

Table 4. Representative soil features

Parent material	(1) Alluvium
Surface texture	(1) Sandy loam (2) Loam (3) Sandy clay loam
Family particle size	(1) Loamy
Drainage class	Poorly drained to well drained
Permeability class	Slow to moderately rapid
Soil depth	72–84 in
Surface fragment cover <=3"	2–10%
Surface fragment cover >3"	0%
Available water capacity (0-40in)	2.5–7.9 in
Calcium carbonate equivalent (0-40in)	0–10%
Electrical conductivity (0-40in)	0–16 mmhos/cm
Sodium adsorption ratio (0-40in)	0–12

Soil reaction (1:1 water) (0-40in)	6.6–9.6
Subsurface fragment volume <=3" (Depth not specified)	2–10%
Subsurface fragment volume >3" (Depth not specified)	0%

## Ecological dynamics

Where management results in abusive livestock use, willows, Wood's rose, sagebrush and rabbitbrush become dominant with increases of wildiris, cinquefoil, and Baltic rush in the understory. Species likely to invade this site are thistles, redtop, and quackgrass. This site is susceptible to gully erosion. As a stream channel becomes entrenched, the water table is lowered and a more drought tolerant vegetation succeeds on the site.

### Fire Ecology:

Most fires kill only aboveground plant parts on willow. Severe fires can completely remove organic soil layers, leaving willow roots exposed and charred and thus eliminating basal sprouting. Willow will generally sprout from its root crown or stem base following fire.

Creeping wildrye is top-killed by fire. Creeping wildrye is generally tolerant of fire but may be damaged by early season fire combined with dry soil conditions. The major adaptation of western wheatgrass to fire is its rhizomatous growth form. During a fire the coarse culms usually burn fast with little or no heat transferred to the roots. Recovery takes about 2 to 5 years after a fire. Basin wildrye is top-killed by fire. Older basin wildrye plants with large proportions of dead material within the perennial crown can be expected to show higher mortality due to fire than younger plants having little debris. Basin wildrye is generally tolerant of fire but may be damaged by early season fire combined with dry soil conditions. Sedge is top-killed by fire, with rhizomes protected by insulating soil. The rhizomes of sedge species may be killed by high-severity fires that remove most of the soil organic layer.

Reestablishment after fire occurs by seed establishment and/or rhizomatous spread. Nevada bluegrass is generally unharmed by fire. It produces little litter, and its small bunch size and sparse litter reduces the amount of heat transferred to perennating buds in the soil. Baltic rush is fire tolerant when dormant and top-killed by fire during the growing season. It establishes after fire through seed and/or lateral spread by rhizomes.

## State and transition model

### Ecosystem states

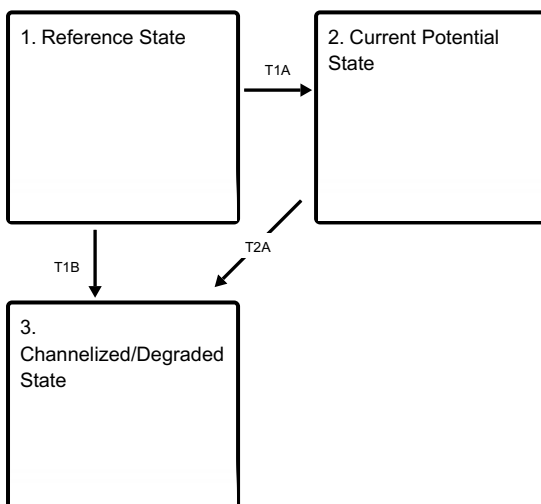

**T1A** - T1A - Introduction of non-native species.

**T1B** - T1B - Channelization of adjacent stream channel.

**T2A** - T2A - Reduced soil moisture and altered hydrology of the site.

### State 1 submodel, plant communities

1.1.  
Willows/graminoids

### State 2 submodel, plant communities

2.1. Native and Non-native shrubs/grasses

### State 3 submodel, plant communities

3.1. Degraded Community Phase

## State 1 Reference State

The Reference State concept has one community phase. Rhizomatous willow and graminoids are less influenced by seasonal flooding and may remain intact after seasonal flooding. This community is fairly stable, unless there are large floods that deposit or erode bank material.

### Community 1.1 Willows/graminoids

The reference plant community is characterized as a dense stand of perennial grasses and forbs with scattered shrubs. The reference plant community is dominated by creeping wildrye. Western wheatgrass and basin wildrye are other important plants associated with this site. Potential vegetative composition is about 80 percent grasses and grass-like plants, 10 percent forbs, and 10 percent shrubs and trees. Approximate ground cover (basal and crown) is 70 to 85 percent.

Table 5. Annual production by plant type

Plant Type	Low (Lb/Acre)	Representative Value (Lb/Acre)	High (Lb/Acre)
Grass/Grasslike	1600	2800	4000
Shrub/Vine	200	350	500
Forb	200	350	500
<b>Total</b>	<b>2000</b>	<b>3500</b>	<b>5000</b>

## State 2 Current Potential State

The Current Potential State occurs after non-native plant species introduction. The species can range from trees, shrubs, to herbaceous. Russian olive, tamarisk, Kentucky bluegrass, and thistles are common non-native plants.

### Community 2.1

## **Native and Non-native shrubs/grasses**

Non-native trees, like Russian olive are present and may dominate the tree canopy. Tamarisk may also occur and take the place of native willows. Kentucky bluegrass is effective at invading wet to semiwet sites and may dominate the understory.

## **State 3**

### **Channelized/Degraded State**

The Channelized/Degraded state is characterized by a adjacent stream that has been channelized. Most seasonal floodwaters remain the in channel and do not inundate the flood plain. This may reduce soil moisture and lower the water table on the site allowing species that are more tolerant to dry conditions to establish.

## **Community 3.1**

### **Degraded Community Phase**

Plant Community Phase 3.1 may look like a drier ecological site with sagebrush or rabbitbrush. This phase may also be converted to a agricultural field or urban development.

## **Transition T1A**

### **State 1 to 2**

Introduction of non-native species.

## **Transition T1B**

### **State 1 to 3**

Channelization of adjacent stream channel.

## **Transition T2A**

### **State 2 to 3**

Reduced soil moisture and altered hydrology of the site. Urbanization and agriculture uses may be present.

## **Additional community tables**

Table 6. Community 1.1 plant community composition



Group	Common Name	Symbol	Scientific Name	Annual Production (Lb/Acre)	Foliar Cover (%)
<b>Grass/Grasslike</b>					
1	<b>Primary Perennial Grasses</b>			2310–4305	
	beardless wildrye	LETR5	<i>Leymus triticoides</i>	1400–2100	–
	western wheatgrass	PASM	<i>Pascopyrum smithii</i>	350–700	–
	basin wildrye	LECI4	<i>Leymus cinereus</i>	350–700	–
	sedge	CAREX	<i>Carex</i>	70–350	–
2	<b>Secondary Perennial Grasses</b>			175–525	
	sloughgrass	BECKM	<i>Beckmannia</i>	18–175	–
	saltgrass	DISP	<i>Distichlis spicata</i>	18–175	–
	spikerush	ELEOC	<i>Eleocharis</i>	18–175	–
	meadow barley	HOBR2	<i>Hordeum brachyantherum</i>	18–175	–
	mat muhly	MURI	<i>Muhlenbergia richardsonis</i>	18–175	–
	annual rabbitsfoot grass	POMO5	<i>Polypogon monspeliensis</i>	18–175	–
	alkali sacaton	SPAI	<i>Sporobolus airoides</i>	18–175	–
<b>Forb</b>					
3	<b>Perennial</b>			175–525	
	sedge	CAREX	<i>Carex</i>	70–350	–
	spikerush	ELEOC	<i>Eleocharis</i>	18–175	–
	horsetail	EQUIS	<i>Equisetum</i>	18–105	–
	Rocky Mountain iris	IRMI	<i>Iris missouriensis</i>	18–105	–
	cinquefoil	POTEN	<i>Potentilla</i>	18–105	–
	ragwort	SENEC	<i>Senecio</i>	18–105	–
	clover	TRIFO	<i>Trifolium</i>	18–105	–
<b>Shrub/Vine</b>					
4	<b>Primary Shrubs</b>			70–280	
	willow	SALIX	<i>Salix</i>	70–280	–
	meadow barley	HOBR2	<i>Hordeum brachyantherum</i>	18–175	–
5	<b>Secondary Shrubs</b>			1–280	
	alkali sacaton	SPAI	<i>Sporobolus airoides</i>	18–175	–
	silver sagebrush	ARCA13	<i>Artemisia cana</i>	18–70	–
	basin big sagebrush	ARTRT	<i>Artemisia tridentata ssp. tridentata</i>	18–70	–
	rubber rabbitbrush	ERNAN5	<i>Ericameria nauseosa ssp. nauseosa var. nauseosa</i>	18–70	–
	Fremont cottonwood	POFR2	<i>Populus fremontii</i>	18–70	–
	Woods' rose	ROWO	<i>Rosa woodsii</i>	18–70	–
	greasewood	SAVE4	<i>Sarcobatus vermiculatus</i>	18–70	–
	silver buffaloberry	SHAR	<i>Shepherdia argentea</i>	18–70	–

## Animal community

Livestock Interpretations:

This site is suited to livestock grazing. Grazing management should be keyed to creeping wildrye, basin wildrye, western wheatgrass and all other perennial grasses. The abundant production of perennial grasses and grass-like

plants occurring on this site provide a valuable source of forage for livestock. Creeping wildrye can be used for forage and is very palatable to all livestock. Once established it is very rhizomatous and maintains stands for many years. Western wheatgrass provides important forage for domestic sheep. Fall regrowth cures well on the stem, so western wheatgrass is good winter forage for domestic livestock. The early growth and abundant production of basin wildrye make it a valuable source of forage for livestock. It is important forage for cattle and is readily grazed by cattle and horses in early spring and fall. Though coarse-textured during the winter, basin wildrye may be utilized more frequently by livestock and wildlife when snow has covered low shrubs and other grasses. Bluegrass is a widespread forage grass. It is one of the earliest grasses in the spring and is sought by domestic livestock and several wildlife species. Nevada bluegrass is a palatable species, but its production is closely tied to weather conditions. It produces little forage in drought years, making it a less dependable food source than other perennial bunchgrasses.

Baltic rush is described as a fair to good forage species for cattle. On average, Baltic rush palatability is considered medium to moderately low. Baltic rush is considered palatable early in the growing season when plants are young and tender, but as stems mature and toughen palatability declines.

In the West, willows are generally considered to be more palatable to sheep than to cattle, but cattle may make greater use of willow because they tend to frequent riparian areas.

Stocking rates vary over time depending upon season of use, climate variations, site, and previous and current management goals. A safe starting stocking rate is an estimated stocking rate that is fine tuned by the client by adaptive management through the year and from year to year.

#### Wildlife Interpretations:

Creeping wildrye is used for forage for many wildlife species and is often used for cover. Basin wildrye provides winter forage for mule deer, though use is often low compared to other native grasses. Basin wildrye provides summer forage for black-tailed jackrabbits. Because basin wildrye remains green throughout early summer, it remains available for small mammal forage for longer time than other grasses. Sedges have a high to moderate resource value for elk and a medium value for mule deer. Elk consume beaked sedge later in the growing season. Baltic rush also provides food for several wildlife species and waterfowl. Baltic rush is an important cover species for a variety of small birds, upland game birds, birds of prey, and waterfowl. Willows provide food and cover for many wildlife species. Willows, in general, are a preferred food and building material of beaver. It is especially important for deer and nongame birds. Willow is moderately to highly palatable for mule deer and elk, and is an important browse during winter. Ducks, grouse, other birds, and small mammals eat willow shoots, catkins, buds, and leaves.

### Hydrological functions

Runoff is low to very low. Gullies are rare to common depending on severity of associated stream channel entrenchment. Gullies and head cuts are healing or stable. Deep-rooted perennial herbaceous bunchgrasses slow runoff and increase infiltration. Tall stature and relatively coarse foliage of wildrye and associated litter break raindrop impact and provide opportunity for snow catch and snow accumulation on site.

### Other products

Native Americans used the leaves of willows to treat mosquito bites, bee stings and stomach aches and used to stems for implements such as baskets, arrow shafts, scoops and fish traps. Basin wildrye was used as bedding for various Native American ceremonies, providing a cool place for dancers to stand. The stems of Baltic rush were historically used by Native Americans as a foundation for coiled basketry.

### Other information

Willow is useful in stabilizing streambanks and providing erosion control on severely disturbed sites. It is valuable in revegetating disturbed riparian sites having high water tables and low elevations. Creeping wildrye is primarily used for reclamation of wet, saline soils. Western wheatgrass is a good soil binder and is well suited for reclamation of disturbed sites such as erosion control and soil stabilization. Basin wildrye is useful in mine reclamation, fire rehabilitation and stabilizing disturbed areas. Its usefulness in range seeding, however, may be limited by initially weak stand establishment. Baltic rush's production of deep and fibrous roots originating from a mass of coarse and creeping rhizomes makes it a valuable species for stabilizing streambanks and protecting against soil erosion.

## Inventory data references

NASIS soil component data.

## Type locality

Location 1: Churchill County, NV	
Township/Range/Section	T18N R28E S3
General legal description	About 2 miles southwest of Fallon, Carson River floodplain, Churchill County, Nevada. This site also occurs in Lyon, Mineral, Pershing and Storey County, Nevada.

## Other references

Fire Effects Information System (Online; <http://www.fs.fed.us/database/feis/plants/>).

USDA-NRCS Plants Database (Online; <http://www.plants.usda.gov>).

## Contributors

DK  
Sarah Quistberg STM

## Approval

Kendra Moseley, 6/03/2024

## Rangeland health reference sheet

Interpreting Indicators of Rangeland Health is a qualitative assessment protocol used to determine ecosystem condition based on benchmark characteristics described in the Reference Sheet. A suite of 17 (or more) indicators are typically considered in an assessment. The ecological site(s) representative of an assessment location must be known prior to applying the protocol and must be verified based on soils and climate. Current plant community cannot be used to identify the ecological site.

Author(s)/participant(s)	GK BRACKLEY
Contact for lead author	State Rangeland Management specialist
Date	06/20/2006
Approved by	Kendra Moseley
Approval date	
Composition (Indicators 10 and 12) based on	Annual Production

## Indicators

1. **Number and extent of rills:** None

---

2. **Presence of water flow patterns:** None

---

3. **Number and height of erosional pedestals or terracettes:** None

---

4. **Bare ground from Ecological Site Description or other studies (rock, litter, lichen, moss, plant canopy are not bare ground):** Bare Ground  $\pm$  20%; surface rock fragments minimal; shrub canopy less than 3% (willows, rose); foliar cover of perennial herbaceous plants  $\pm$  80%.
- 
5. **Number of gullies and erosion associated with gullies:** Gullies are rare to common depending on severity of associated stream channel entrenchment. Gullies and head cuts are healing or stable.
- 
6. **Extent of wind scoured, blowouts and/or depositional areas:** None
- 
7. **Amount of litter movement (describe size and distance expected to travel):** Fine litter (foliage of grasses and annual & perennial forbs) is only expected to move during periods of flooding by adjacent streams. Persistent litter (large woody material) will remain in place except during peak flooding periods.
- 
8. **Soil surface (top few mm) resistance to erosion (stability values are averages - most sites will show a range of values):** Soil stability values will range from 4 to 6. (To be field tested.)
- 
9. **Soil surface structure and SOM content (include type of structure and A-horizon color and thickness):** Soil surface structure is platy, subangular blocky or granular. Soil surface colors are very dark and have mollic epipedons. Organic carbon can range from 2 to 3.5 percent for much of the upper 20 inches. (OM values derived from lab characterization data.)
- 
10. **Effect of community phase composition (relative proportion of different functional groups) and spatial distribution on infiltration and runoff:** Deep-rooted perennial herbaceous bunchgrasses slow runoff and increase infiltration. Tall stature and relatively coarse foliage of wildrye and associated litter break raindrop impact and provide opportunity for snow catch and snow accumulation on site.
- 
11. **Presence and thickness of compaction layer (usually none; describe soil profile features which may be mistaken for compaction on this site):** None - Platy subsurface layers are not to be interpreted as compaction.
- 
12. **Functional/Structural Groups (list in order of descending dominance by above-ground annual-production or live foliar cover using symbols: >>, >, = to indicate much greater than, greater than, and equal to):**
- Dominant: Reference Plant Community: Tall statured, deep-rooted, cool season, perennial bunchgrasses = rhizomatous, cool season, perennial bunchgrasses. (By above ground production)
- Sub-dominant: Deep-rooted, cool season, perennial forbs > shallow-rooted, cool season, perennial bunchgrasses and grass-like plants > fibrous, shallow-rooted, cool season, perennial forbs>tall shrubs (willow). (By above ground production)
- Other:
- Additional:

---

13. **Amount of plant mortality and decadence (include which functional groups are expected to show mortality or decadence):** Herbaceous species show minimal mortality. Dead branches within individual shrubs are common and standing dead shrub canopy material may be as much as 15% of total woody canopy.

---

14. **Average percent litter cover (%) and depth ( in):** Within plant interspaces ( $\pm 80\%$ ) and depth (1 to 3 in.)

---

15. **Expected annual annual-production (this is TOTAL above-ground annual-production, not just forage annual-production):** For normal or average growing season (September thru July)  $\pm 2500$  lbs/ac; Spring flooding significantly affects total production.

---

16. **Potential invasive (including noxious) species (native and non-native). List species which BOTH characterize degraded states and have the potential to become a dominant or co-dominant species on the ecological site if their future establishment and growth is not actively controlled by management interventions. Species that become dominant for only one to several years (e.g., short-term response to drought or wildfire) are not invasive plants. Note that unlike other indicators, we are describing what is NOT expected in the reference state for the ecological site:** Saltcedar, quackgrass, foxtail barley, thistle, annual kochia, hoary cress, tall whitetop and annual, warm-season grasses are invaders on this site. Willow and rubber rabbitbrush are increasers on this site.

---

17. **Perennial plant reproductive capability:** All functional groups should reproduce in most years.

---