

Ecological site R027XY004NV WET MEADOW 8-12 P.Z.

Last updated: 6/03/2024
Accessed: 06/30/2024

General information

Provisional. A provisional ecological site description has undergone quality control and quality assurance review. It contains a working state and transition model and enough information to identify the ecological site.

MLRA notes

Major Land Resource Area (MLRA): 027X–Fallon-Lovelock Area

Physiography

Found in the Great Basin Section of the Basin and Range Province of the Intermontane Plateaus this area is characterized by isolated uplifted fault block mountain ranges trending north to south that are separated by broad, hydrologically closed basins. The entire area occurs in the rain-shadow of the Sierra Nevada mountains and is influenced by Pleistocene Lake Lahontan which reached its most recent high stand about 12,000 years ago. There is substantial evidence suggesting the western Great Basin has been the site of pluvial-interpluvial cycles for at least the past two million years.

The mountains and valleys are dissected by the Humboldt, Truckee, Carson, and Walker Rivers and their tributaries, all of which terminate within MLRA 27. Extensive playas can be found throughout this area and are the result of drying of ancient Lake Lahontan. Elevation generally ranges from 3,300 to 5,900 feet (1,005 to 1,800 meters) in valleys, but on some mountain peaks it is more than 7,870 feet (2,400 meters).

Geology

Landforms and soils of this MLRA have been heavily influenced by fluctuating lake level over the last 40,000 years. There is a level line evident on the higher slopes marking the former extent of glacial Lake Lahontan. Almost half of this area has surface deposits of alluvial valley fill influenced by lacustrine sediment. The rest has andesite and basalt rocks of different ages. Mesozoic and Tertiary intrusives are concentrated along the western border of the area, and Lower Volcanic Rocks (17 to 43 million years old) are common on the eastern side of the area. Also, some scattered outcrops of Mesozoic sedimentary and volcanic rocks and tuffaceous sedimentary rocks are in the mountains within the interior of this MLRA.

Climate

The average annual precipitation is 5 to 10 inches (125 to 255 millimeters) in most of the area but is as much as 19 inches (485 millimeters) on high mountain slopes. Most of the rainfall occurs as high-intensity, convective thunderstorms during the growing season. The amount of precipitation is very low from summer to midautumn. The precipitation in winter occurs mainly as snow. The average annual temperature is 43 to 54 degrees F (6 to 12 degrees C). The freeze-free period averages 155 days and ranges from 110 to 195 days, decreasing in length with elevation.

Water

The amount of precipitation is very low, and water for irrigation is obtained principally from diversions on the four large rivers in the area and from water stored in the Lahontan, Rye Patch, and Weber Reservoirs. Pyramid Lake and Walker Lakes are terminal lakes for the Truckee and Walker Rivers, respectively. Much of the annual flow of both rivers is diverted for irrigation, causing lake levels to fall and levels of dissolved salts to increase causing problems for the native Lahontan cutthroat trout.

Soils

The dominant soil orders are Aridisols and Entisols. The soils in the area are predominantly a mesic temperature

regime, aridic moisture regime, and have a mixed mineralogy. They are generally well drained, loamy or sandy, commonly skeletal, and shallow to very deep. Accumulation of salts, tufa deposits, and eolian sediments with soluble salts over lacustrine deposits influence most of the soils in the basin landforms of this MLRA. Soils on bedrock-controlled landforms are typically comprised of volcanic or tuffaceous sedimentary colluvium over residuum.

Biological Resources

This area supports extensive areas of salt-desert shrub vegetation. Shadscale and Bailey's greasewood are widespread, occurring both individually and together. Grasses are generally sparse, although Indian ricegrass is prominent, especially on the sandy soils. Fourwing saltbush, winterfat, spiny hopsage, wolfberry, ephedra, dalea, and bud sagebrush are common shrubs. Basin wildrye, creeping wildrye, alkali sacaton, saltgrass, black greasewood, rubber rabbitbrush, and big saltbush are important plants on saline bottom lands and terraces. A few marsh areas support cattail, bulrushes, sedges, and rushes. Big sagebrush, along with scattered Utah juniper and singleleaf pinyon, is associated with Thurber needlegrass, desert needlegrass, Sandberg bluegrass, and squirreltail on the higher elevation piedmont slopes and mountains.

Ecological site concept

The Wet Meadow 8-12 P.Z. site occurs on flood plains and stream terraces. Slope gradients of 1 to 6 percent are typical. Elevations are 4000 to 9200 feet. The soils are fertile and very deep. The site has a water table at or near the surface early in the spring that usually stabilizes to within 20 inches of the soil surface through the growing season. The site is rarely flooded for very brief periods in the spring by stream overflow or unconfined runoff from surrounding areas. Some sites are kept moist through the growing season by springs and seeps.

Associated sites

R027XY001NV	WETLAND TYPHA-ELPA3 codominant grasses; soils typically saturated through growing season; soils have a histic epipedon
-------------	--

Similar sites

R027XY005NV	SALINE MEADOW SPA1-DISP codominant grasses; soils saline/alkali
R027XY069NV	WET MEADOW 4-8 P.Z. Lower elevations; POJU dominant grass; DISP important grass

Table 1. Dominant plant species

Tree	Not specified
Shrub	Not specified
Herbaceous	(1) <i>Carex</i> (2) <i>Poa nevadensis</i>

Physiographic features

The Wet Meadow 8-12 P.Z. site occurs on flood plains and stream terraces. Slope gradients of 1 to 6 percent are typical. Elevations are 4000 to 9200 feet.

Table 2. Representative physiographic features

Landforms	(1) Flood plain (2) Stream terrace
Runoff class	High to very high
Flooding duration	Very brief (4 to 48 hours)
Flooding frequency	Rare

Ponding frequency	None
Elevation	4,000–9,200 ft
Slope	1–6%
Water table depth	18–30 in
Aspect	Aspect is not a significant factor

Climatic features

The climate associated with this site is arid, characterized by cool, moist winters and hot, dry summers. Average annual precipitation is 5 inches. Mean annual air temperature is 42 to 50 degrees F. The average growing season is about 90 to 120 days.

Table 3. Representative climatic features

Frost-free period (characteristic range)	89-127 days
Freeze-free period (characteristic range)	111-173 days
Precipitation total (characteristic range)	5 in
Frost-free period (actual range)	80-144 days
Freeze-free period (actual range)	101-191 days
Precipitation total (actual range)	5-6 in
Frost-free period (average)	109 days
Freeze-free period (average)	144 days
Precipitation total (average)	5 in

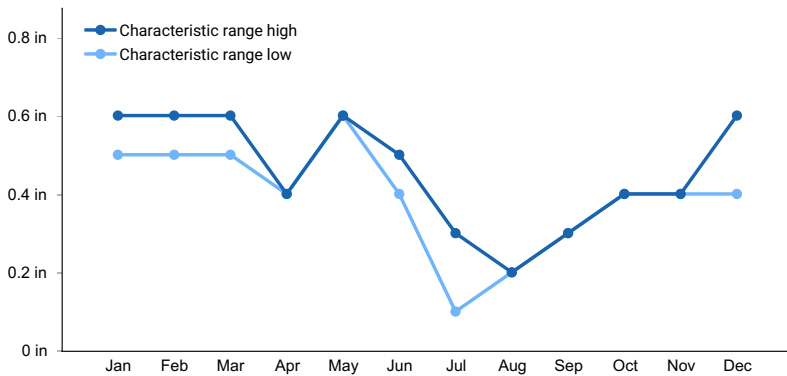

Figure 1. Monthly precipitation range

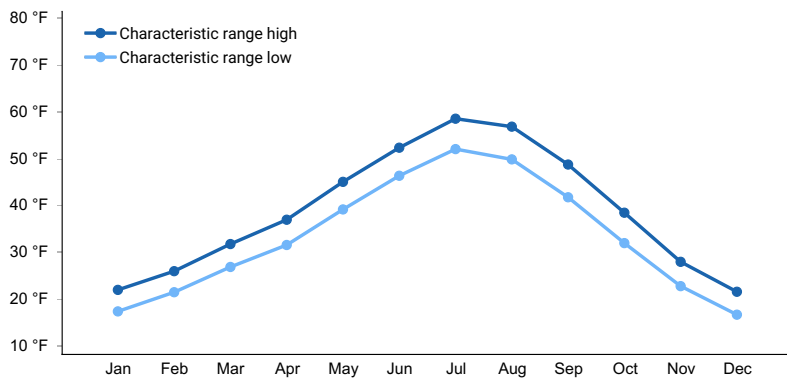

Figure 2. Monthly minimum temperature range

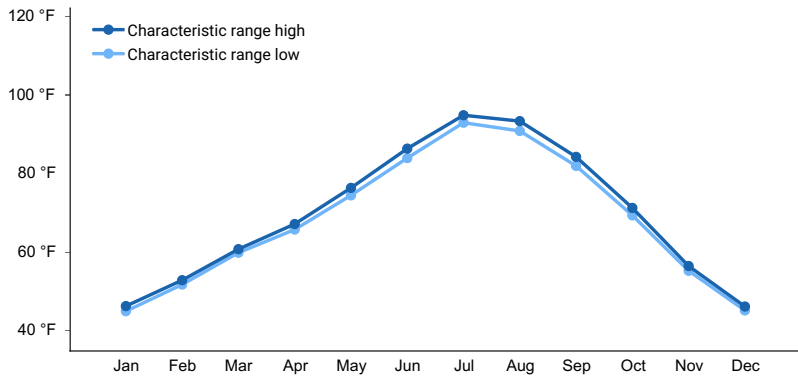

Figure 3. Monthly maximum temperature range

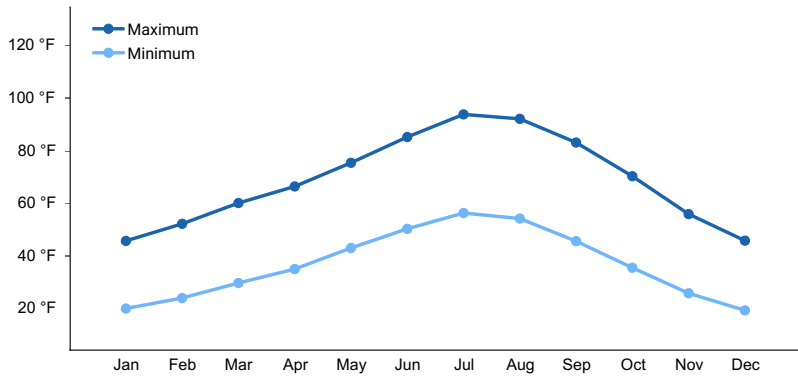

Figure 4. Monthly average minimum and maximum temperature

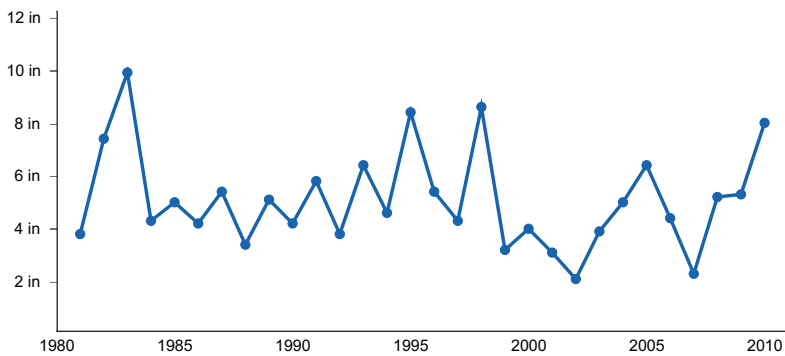

Figure 5. Annual precipitation pattern

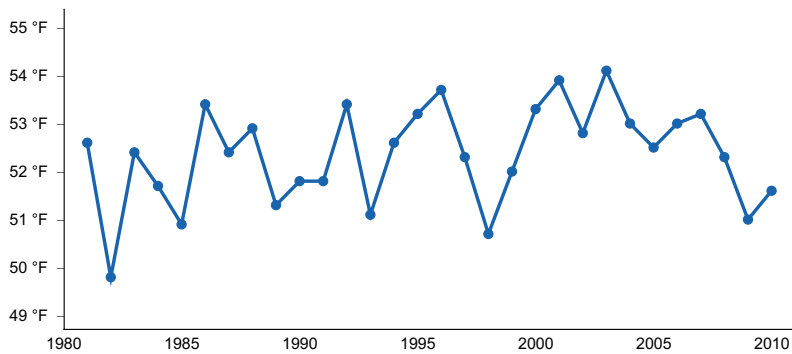

Figure 6. Annual average temperature pattern

Climate stations used

- (1) LAHONTAN DAM [USC00264349], Fallon, NV
- (2) YERINGTON [USC00269229], Yerington, NV
- (3) WABUSKA 6 SE [USC00268822], Yerington, NV

- (4) SMITH 6 N [USC00267612], Wellington, NV
- (5) FALLON EXP STN [USC00262780], Fallon, NV

Influencing water features

This site is associated with seeps and springs.

Soil features

The soils associated with this site are fertile, very deep and have a very low to high available water capacity. These soils are somewhat poorly drained and have a water table at or near the surface early in the spring that usually stabilizes to within 20 inches of the soil surface through the growing season. The soils are rarely flooded for very brief periods in the spring by stream overflow or unconfined runoff from surrounding areas. Some soils are kept moist through the growing season by springs and seeps. Runoff is high to very high and ponding occurs in some areas. These soils are susceptible to gully erosion which intercepts normal overflow patterns and results in site degradation. Soil temperature regime is mesic. The soil series associated with this site include: Dia, Dithod, Fernley, Obanion, Rosecreek, and Sagoupe.

Table 4. Representative soil features

Parent material	(1) Alluvium
Surface texture	(1) Gravelly sand (2) Clay loam (3) Silty clay loam
Family particle size	(1) Clayey
Drainage class	Somewhat poorly drained
Permeability class	Slow to moderately rapid
Soil depth	72–84 in
Surface fragment cover <=3"	2–14%
Surface fragment cover >3"	0%
Available water capacity (0-40in)	3–8 in
Calcium carbonate equivalent (0-40in)	0–3%
Electrical conductivity (0-40in)	0–4 mmhos/cm
Sodium adsorption ratio (0-40in)	0–35
Soil reaction (1:1 water) (0-40in)	6.6–9
Subsurface fragment volume <=3" (Depth not specified)	2–14%
Subsurface fragment volume >3" (Depth not specified)	0%

Ecological dynamics

Where management results in abusive livestock use, palatable sedges and Nevada bluegrass decrease as Baltic rush, foxtail barley, wild iris, cinquefoil and western yarrow become dominant. Willows and rose will also increase. Species likely to invade this site are thistles, redtop, and quackgrass. This site is susceptible to gully erosion. As a stream channel becomes entrenched, the water table is lowered and a more drought tolerant vegetation succeeds on the site.

Fire Ecology:

Fire in wet meadow communities often only top-kills plants. Prescribed fires are most effective in late summer, early fall, or during dry years when the water is below the soil surface. The sedges have deep buried rhizomes which usually survive all but the most severe fires. Sedge is top-killed by fire, with rhizomes protected by insulating soil. The rhizomes of *Carex* species may be killed by high-severity fires that remove most of the soil organic layer. Reestablishment after fire occurs by seed establishment and/or rhizomatous spread. Nevada bluegrass is generally unharmed by fire. It produces little litter, and its small bunch size and sparse litter reduces the amount of heat transferred to perennating buds in the soil. Rushes are fire tolerant when dormant and top-killed by fire during the growing season. They establish after fire through seed and/or lateral spread by rhizomes. Meadow barley has high fire tolerance. Meadow barley grows in moist habitats that experience infrequent fire.

State and transition model

Ecosystem states

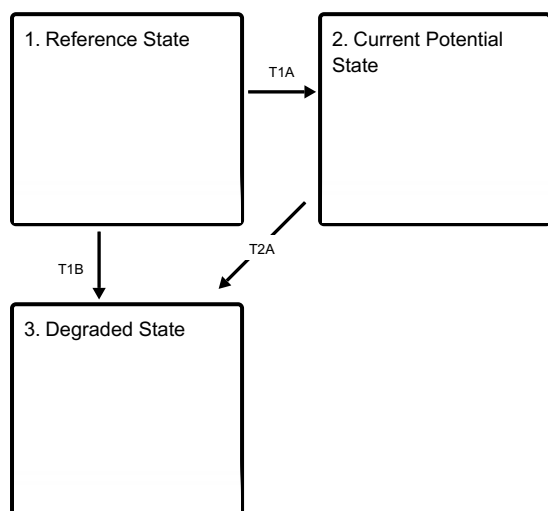

T1A - T1A - Introduction of non-native species.

T1B - T1B - Lowering of water table.

T2A - T2A - Reduced soil moisture and altered hydrology of the site.

State 1 submodel, plant communities

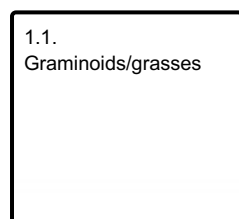

State 2 submodel, plant communities

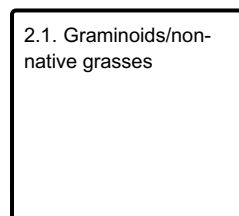

State 3 submodel, plant communities

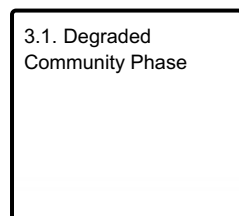

State 1 Reference State

The Reference State is a site that is in balance with the natural water fluctuations and plant species adapted to wet conditions during the growing season. Disruptions to the natural water regime will allow other plants to become established, both native and non-native, this will move the site to an alternative state.

Community 1.1 Graminoids/grasses

The reference plant community is dominated by sedges, rushes and Nevada bluegrass. Potential vegetative composition is about 80 percent grasses and grass-like plants, 15 percent forbs, and up to 5 percent shrubs. Approximate ground cover (basal and crown) is 75 to 85 percent.

Table 5. Annual production by plant type

Plant Type	Low (Lb/Acre)	Representative Value (Lb/Acre)	High (Lb/Acre)
Grass/Grasslike	1215	2445	3675
Forb	225	450	675
Shrub/Vine	60	105	150
Total	1500	3000	4500

State 2 Current Potential State

The Current Potential State is similar to the Reference State, with the exception of including non-native plants in the community.

Community 2.1 Graminoids/non-native grasses

Similar to Community Phase 1.1 with the inclusion of non-native plants.

State 3 Degraded State

The Degraded State occurs when the natural water regime is disrupted and the water table is lowered throughout all seasons. This can occur through water withdrawals upstream of the site, channelization, disturbance below the site that causes gulying.

Community 3.1 Degraded Community Phase

Plant Community Phase 3.1 may look like a drier ecological site with sagebrush or rabbitbrush.

Transition T1A State 1 to 2

Introduction of non-native species.

Transition T1B State 1 to 3

Lowering of water table.

Transition T2A State 2 to 3

Reduced soil moisture and altered hydrology of the site.

Additional community tables

Table 6. Community 1.1 plant community composition

Group	Common Name	Symbol	Scientific Name	Annual Production (Lb/Acre)	Foliar Cover (%)
Grass/Grasslike					
1	Primary Perennial Grasses/grasslikes			1260–2240	
	sedge	CAREX	<i>Carex</i>	600–1050	–
	rush	JUNCU	<i>Juncus</i>	150–450	–
	meadow barley	HOBR2	<i>Hordeum brachyantherum</i>	60–240	–
2	Secondary Perennial Grasses/grasslikes			150–450	
	tufted hairgrass	DECE	<i>Deschampsia cespitosa</i>	15–90	–
	spikerush	ELEOC	<i>Eleocharis</i>	15–90	–
	thickspike wheatgrass	ELLA3	<i>Elymus lanceolatus</i>	15–90	–
	slender wheatgrass	ELTR7	<i>Elymus trachycaulus</i>	15–90	–
	foxtail barley	HOJU	<i>Hordeum jubatum</i>	15–90	–
	basin wildrye	LECI4	<i>Leymus cinereus</i>	15–90	–
	beardless wildrye	LETR5	<i>Leymus triticoides</i>	15–90	–
	western wheatgrass	PASM	<i>Pascopyrum smithii</i>	15–90	–
	common reed	PHAU7	<i>Phragmites australis</i>	15–90	–
Forb					
3	Perennial			300–600	
	basin wildrye	LECI4	<i>Leymus cinereus</i>	15–90	–
	horsetail	EQUIS	<i>Equisetum</i>	15–90	–
	Rocky Mountain iris	IRMI	<i>Iris missouriensis</i>	15–90	–
	clover	TRIFO	<i>Trifolium</i>	15–90	–
Shrub/Vine					
4	Secondary Shrubs			0–150	
	thickspike wheatgrass	ELLA3	<i>Elymus lanceolatus</i>	15–90	–
	beardless wildrye	LETR5	<i>Leymus triticoides</i>	15–90	–
	western wheatgrass	PASM	<i>Pascopyrum smithii</i>	15–90	–
	Woods' rose	ROWO	<i>Rosa woodsii</i>	15–60	–
	willow	SALIX	<i>Salix</i>	15–60	–

Animal community

Livestock Interpretations:

This site is suited to livestock grazing. Grazing management should be keyed to sedge, Nevada bluegrass, and other perennial grass production. Sedge provides good to fair forage for domestic grazing. Nevada bluegrass is a widespread forage grass. It is one of the earliest grasses in the spring and is sought by domestic livestock and several wildlife species. Nevada bluegrass is a palatable species, but its production is closely tied to weather conditions. It produces little forage in drought years, making it a less dependable food source than other perennial bunchgrasses.

Rushes are described as a fair to good forage species for cattle. On average, rush palatability is considered medium to moderately low. Rushes are considered palatable early in the growing season when plants are young

and tender, but as stems mature and toughen palatability declines. Meadow barley tends to increase and replace the more palatable plants in moist meadows and in other sites favorable to growth, especially if such areas are somewhat overgrazed.

Stocking rates vary over time depending upon season of use, climate variations, site, and previous and current management goals. A safe starting stocking rate is an estimated stocking rate that is fine tuned by the client by adaptive management through the year and from year to year.

Wildlife Interpretations:

Sedges have a high to moderate resource value for elk and a medium value for mule deer. Elk consume beaked sedge later in the growing season. Nevada bluegrass is an important forage species for several wildlife species. Rushes provide food for several wildlife species and waterfowl. Rushes are an important cover species for a variety of small birds, upland game birds, birds of prey, and waterfowl. Meadow barley is an important forage species for many wildlife species.

Hydrological functions

Runoff is high to very high. Gullies are rare to common depending on severity of associated stream channel entrenchment. Gullies and head cuts are healing or stable. Where this site is not associated with perennial or ephemeral channels gullies are none. Deep-rooted, cool-season, perennial bunchgrasses and rhizomatous grasses and grass-like plants slow runoff and increase infiltration. Relatively dense foliar cover of perennial grasses and grass-like plants and associated litter break raindrop impact and slow overland flow.

Recreational uses

Aesthetic value is derived from the diverse floral and faunal composition and the colorful flowering of wild flowers and shrubs during the spring and early summer. This site offers rewarding opportunities to photographers and for nature study.

Inventory data references

NASIS soil component data.

Type locality

Location 1: Churchill County, NV	
General legal description	This site also occurs in Lyon, Mineral and Pershing Counties, Nevada.

Other references

Fire Effects Information System (Online; <http://www.fs.fed.us/database/feis/plants/>).

USDA-NRCS Plants Database (Online; <http://www.plants.usda.gov>).

Contributors

DK/GD

Sarah Quistberg (STM)

Approval

Kendra Moseley, 6/03/2024

Rangeland health reference sheet

Interpreting Indicators of Rangeland Health is a qualitative assessment protocol used to determine ecosystem condition based on benchmark characteristics described in the Reference Sheet. A suite of 17 (or more) indicators

are typically considered in an assessment. The ecological site(s) representative of an assessment location must be known prior to applying the protocol and must be verified based on soils and climate. Current plant community cannot be used to identify the ecological site.

Author(s)/participant(s)	GK BRACKLEY
Contact for lead author	State Rangeland Management Specialist
Date	06/20/2006
Approved by	Kendra Moseley
Approval date	
Composition (Indicators 10 and 12) based on	Annual Production

Indicators

1. **Number and extent of rills:** None
-

2. **Presence of water flow patterns:** None
-

3. **Number and height of erosional pedestals or terracettes:** None
-

4. **Bare ground from Ecological Site Description or other studies (rock, litter, lichen, moss, plant canopy are not bare ground):** Bare Ground \pm 20%; surface rock fragments minimal; shrub canopy is minimal; foliar cover of perennial herbaceous plants \pm 85%.
-

5. **Number of gullies and erosion associated with gullies:** Gullies are rare to common depending on severity of associated stream channel entrenchment. Gullies and head cuts are healing or stable. Where this site is not associated with perennial or ephemeral channels gullies are none.
-

6. **Extent of wind scoured, blowouts and/or depositional areas:** None
-

7. **Amount of litter movement (describe size and distance expected to travel):** Fine litter (foliage of grasses and annual & perennial forbs) is only expected to move during periods of flooding by adjacent streams. Persistent litter (large woody material) will remain in place except during peak flooding periods.
-

8. **Soil surface (top few mm) resistance to erosion (stability values are averages - most sites will show a range of values):** Soil stability values will range from 2 to 4. (To be field tested.)
-

9. **Soil surface structure and SOM content (include type of structure and A-horizon color and thickness):** Soil surface structure is platy, sub-angular blocky, or massive. Soil surface colors are dark and the soils have mollic epipedons. Organic carbon can range from 2.5 to over 5 percent in the upper 10 inches. (OM values derived from lab

characterization data.)

10. **Effect of community phase composition (relative proportion of different functional groups) and spatial distribution on infiltration and runoff:** Deep-rooted, cool-season, perennial bunchgrasses and rhizomatous grasses and grass-like plants slow runoff and increase infiltration. Relatively dense foliar cover of perennial grasses and grass-like plants and associated litter break raindrop impact and slow overland flow.
-

11. **Presence and thickness of compaction layer (usually none; describe soil profile features which may be mistaken for compaction on this site):** None to slight - Platy or massive subsurface layers are not to be interpreted as compaction.
-

12. **Functional/Structural Groups (list in order of descending dominance by above-ground annual-production or live foliar cover using symbols: >>, >, = to indicate much greater than, greater than, and equal to):**

Dominant: Reference Plant Community: Deep-rooted, cool season, perennial bunchgrasses >> rhizomatous, cool season, perennial grass-like plants. (By above ground production)

Sub-dominant: Deep-rooted, cool season, perennial forbs > rhizomatous, cool season, perennial grasses > shallow-rooted, cool season, perennial bunchgrasses and grass-like plants > fibrous, shallow-rooted, cool season, perennial forbs > tall shrubs. (By above ground production)

Other:

Additional:

13. **Amount of plant mortality and decadence (include which functional groups are expected to show mortality or decadence):** Herbaceous plant mortality or decadence uncommon.
-

14. **Average percent litter cover (%) and depth (in):** Within plant interspaces (85+%) and depth of litter is 1 to 3 inches.
-

15. **Expected annual annual-production (this is TOTAL above-ground annual-production, not just forage annual-production):** For normal or average growing season (April thru July) \pm 1500 lbs/ac; Spring flooding significantly affects total production.
-

16. **Potential invasive (including noxious) species (native and non-native). List species which BOTH characterize degraded states and have the potential to become a dominant or co-dominant species on the ecological site if their future establishment and growth is not actively controlled by management interventions. Species that become dominant for only one to several years (e.g., short-term response to drought or wildfire) are not invasive plants. Note that unlike other indicators, we are describing what is NOT expected in the reference state for the ecological site:** Willow, rose, foxtail barley; rubber rabbitbrush; wildiris, thistle; tall whitetop, hoarycress
-

17. **Perennial plant reproductive capability:** All functional groups should reproduce in most years.

