

Ecological site DX034A02X166 Shallow Sandy Pinedale Plateau (SwSy PP)

Last updated: 5/01/2024
Accessed: 05/18/2024

General information

Provisional. A provisional ecological site description has undergone quality control and quality assurance review. It contains a working state and transition model and enough information to identify the ecological site.

MLRA notes

Major Land Resource Area (MLRA): 034A–Cool Central Desertic Basins and Plateaus

Major Land Resource Area (MLRA) 34A, Cool Central Desertic Basins and Plateaus, consists of approximately 21 million acres in Wyoming, Colorado and Utah, it consists of 10 Land Resource Units (LRU). These units are divisions of the MLRA based on geology, landscape, common soils, water resources and plant community potentials. The elevation ranges from approximately 5600 feet (1700 m) along the Green River in UT and CO to approximately 9500 feet (2900 m) near Jeffrey City, WY. Annual precipitation ranges from 7 to 16 inches (177 to 406 mm), with the driest areas in the Green River and Great Divide Basins and the wettest areas in northern Carbon County, Southeast Fremont County and Albany County. There is a seasonal weather pattern that trends west to east, with more winter precipitation in the west and more spring/summer in the east, illustrated by diminishing amounts of Big Sagebrush in the eastern part of the MLRA.

LRU notes

The Pinedale Plateau LRU is in the upper Green River Drainage from Pinedale, Wyoming at the north working southward to Farson, Wyoming and easterly to South Pass, Wyoming. It is situated between the Wyoming Range and Wind River Range largely in Sublette County with some areas in Lincoln County, northern Sweetwater County, and a small portion of Fremont County. The total area of this LRU is approximately 1,210,000 acres. It shares a boundary with MLRA 46-Northern Rocky Mountain Foothills (proposed for the foothills of western Wyoming). This LRU is dominated by the New Fork Tongue of the Wasatch formation, a large artesian aquifer that is estimated to hold large amounts of water with relatively quick recharge (Martin 1996). It is also home to the Lance Formation, a cretaceous strata that is part of the Mesaverde Group, which holds large amounts of hydrocarbons, giving way to one of the largest on shore natural gas fields (Jonah Field) (Bowker et al 2000). The soils in the Pinedale Plateau are dominated by older Alfisols with thick argillic and calcic horizons and younger deep alluvial soils along drainage ways and in river bottoms. Salts are not a major influence in the Pinedale Plateau compared to the adjacent Green River Basin LRU but do occur, including sodium, calcium carbonate, and other soluble salts. Soils are tied closely to their parent geology but are more developed and older so typically do not have bedrock contact within six feet. This LRU has an aridic ustic soil moisture regime and frigid (bordering on cryic) soil temperature regime. The precipitation pattern is bimodal with a slight spikes in the spring and fall. Winter temperatures are cold allowing snow to accumulate and stay until spring. This lends perfectly to cool season grasses and forbs to flourish, also allowing big sagebrush to establish and dominate the landscape. The mean annual soil temperatures are between 36 to 40 degree Fahrenheit (2.2 to 4.4 degree Celsius) and average precipitation is between 9 and 12 inches (230 to 305 mm) annually. Elevations of this LRU range between 6500 and 7500 feet (1980 to 2280 m).

Classification relationships

Relationship to Other Established Classification Systems

National Vegetation Classification System (NVC):

3 Semi-Desert

3.B.1 Cool Semi-Desert Scrub & Grassland

3.B.1.Ne Western North American Cool Semi-Desert Scrub & Grassland Division
M169 Great Basin & Intermountain Tall Sagebrush Shrubland & Steppe Macrogroup
G303 Intermountain Dry Tall Sage Steppe and Shrubland Group
A3184 Wyoming big sagebrush Dry Steppe and Shrubland Alliance
CEGL002761 *Artemisia tridentata* ssp. *wyomingensis*/*Hesperostipa comata* Shrubland Association

Ecoregions (EPA):

Level I: 10 North American Deserts

Level II: 10.1 Cold Deserts

Level III: 10.1.4 Wyoming Basin

Ecological site concept

This site not does receive any additional water.

Soils:

o are not saline or saline-sodic

o are typically shallow (10-20 inches deep)

o are typically skeletal within 20 inches (50 cm) of the soil surface (greater than 35 percent rock fragments by volume)

o are not violently effervescent in the surface mineral layer (within top 10 inches; 25 cm)

o have surface textures that usually range from loamy coarse sand to fine sandy loam in surface mineral layer (4 inches; 10 cm)

o have slopes that range from 15-45 percent

o have clay content less than 18 percent in mineral soil surface layer (6 inches; 15 cm)

Climate:

aridic ustic moisture regime (ustic bordering on aridic)

frigid (bordering on cryic) temperature regime

Associated sites

DX034A02X150	Sandy Pinedale Plateau (Sy PP) Soils are deeper (moderately deep to very deep) and are not skeletal higher plant production potential.
DX034A02X122	Loamy Pinedale Plateau (Ly PP) Soils are deeper (moderately deep to very deep) and are not skeletal with higher plant production potential.
DX034A02X162	Shallow Loamy Pinedale Plateau (SwLy PP) Soil surface textures are heavier (fine sandy loam to clay loam) with lower production potential.

Similar sites

DX034A02X163	Shallow Loamy Calcareous Pinedale Plateau (SwLyc PP) Site has higher calcium carbon equivalent (>15% CCE) but can have similar soil surface texture with different species composition potential.
R034AY266WY	Shallow Sandy Foothills and Basins West (SwSy) Previous version of this site, but applied to a larger geographic area.
R034AY166WY	Shallow Sandy Green River and Great Divide Basins (SwSy) Similar site with drier climate and lower plant production potential found in the adjacent Green River Basin LRU.

Table 1. Dominant plant species

Tree	Not specified
Shrub	(1) <i>Artemisia tridentata</i> ssp. <i>wyomingensis</i>
Herbaceous	(1) <i>Hesperostipa comata</i> (2) <i>Achnatherum hymenoides</i>

Legacy ID

R034AC166WY

Physiographic features

This site occurs in intermontane basin landscapes on hill and hillslope landforms (see following definitions). The slopes typically range from 15 to 45 percent, but can occur from 0 to greater than 50 percent. This site occurs on all aspects.

Landscape Definitions:

intermontane basin—A generic term for wide structural depressions between mountain ranges that are partly filled with alluvium and called "valleys" in the vernacular.

Landform Definitions:

hills -- A landscape dominated by hills and associated valleys. The landform term is singular (hill).

hillslope -- A generic term for the steeper part of a hill between its summit and the drainage line, valley flat, or depression floor at the base of the hill.

Table 2. Representative physiographic features

Landforms	(1) Intermontane basin > Hill (2) Hillslope
Flooding frequency	None
Ponding frequency	None
Elevation	1,981–2,286 m
Slope	15–45%
Aspect	Aspect is not a significant factor

Climatic features

Annual precipitation ranges from 9 to 12 inches per year. Wide fluctuations may occur in yearly precipitation and result in more below average years than those with above average precipitation. Temperatures show a wide range between summer and winter and between daily maximums and minimums. This is predominantly due to the high elevation and dry air, which permits rapid incoming and outgoing radiation. Cold air outbreaks in winter move rapidly from northwest to southeast and account for extreme minimum temperatures. Much of the precipitation accumulation (45 percent) comes in the winter in the form of snow (October to April). The wettest month is May (1.69 inches). The dominant plants (sagebrush and cool season grasses) are well adapted to these conditions. Daytime winds are generally stronger than nighttime and occasional strong storms may bring brief periods of high winds with gusts to more than 50 miles per hour. The growing season is short (less than 60 day) and cool. Critical growth period: primary growth typically occurs between May and June.

Growth of native cool-season plants begins in April and continues to approximately early August. Some green-up of cool-season plants usually occurs in September with adequate fall moisture.

All data is based on the 30-year average from 1981-2010.

Table 3. Representative climatic features

Frost-free period (characteristic range)	30-70 days
Freeze-free period (characteristic range)	50-80 days
Precipitation total (characteristic range)	229-305 mm
Frost-free period (actual range)	15-70 days
Freeze-free period (actual range)	45-90 days
Precipitation total (actual range)	229-330 mm

Frost-free period (average)	36 days
Freeze-free period (average)	64 days
Precipitation total (average)	279 mm

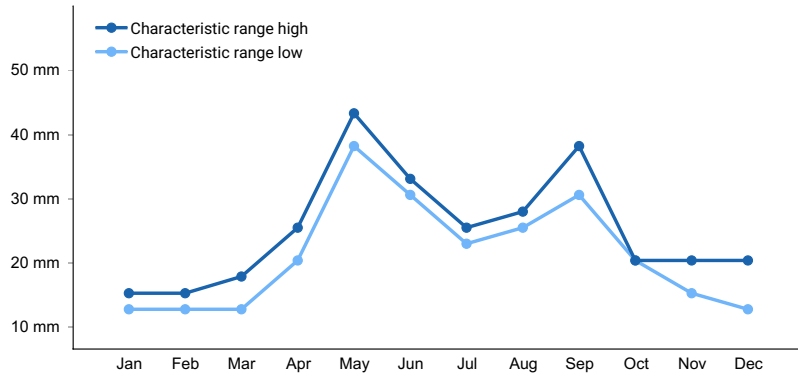

Figure 1. Monthly precipitation range

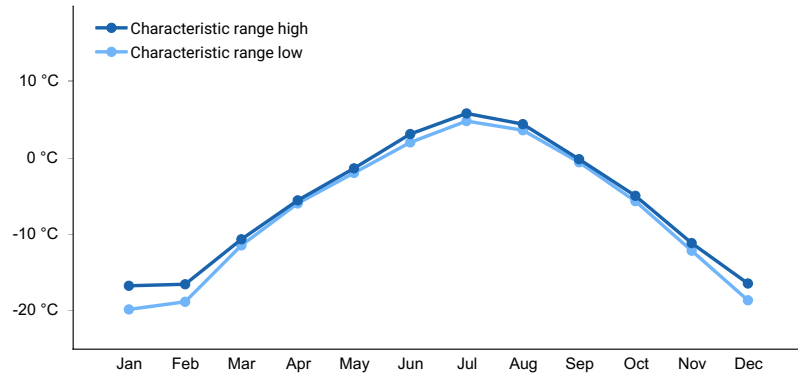

Figure 2. Monthly minimum temperature range

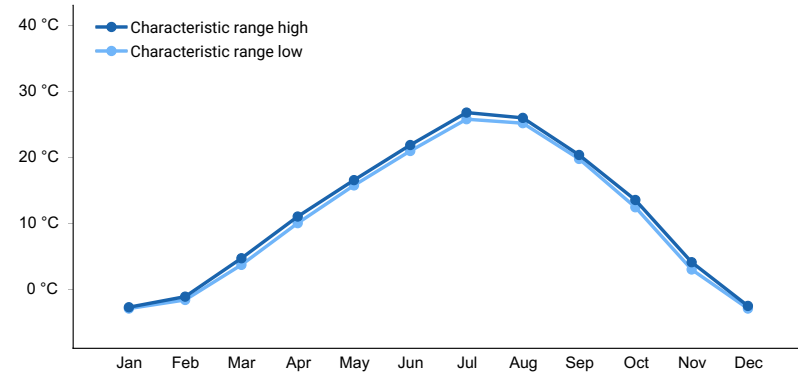

Figure 3. Monthly maximum temperature range

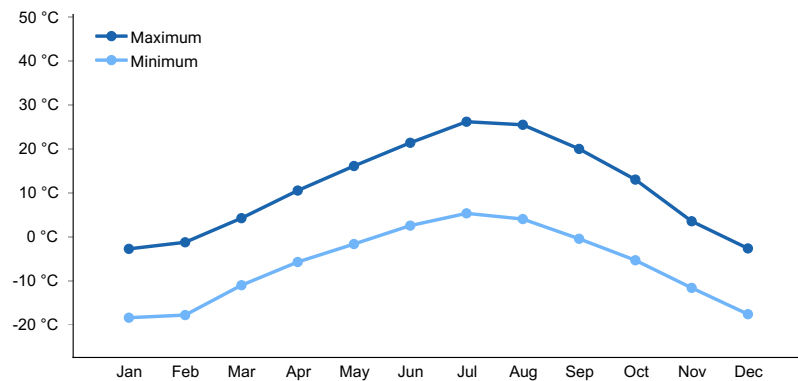

Figure 4. Monthly average minimum and maximum temperature

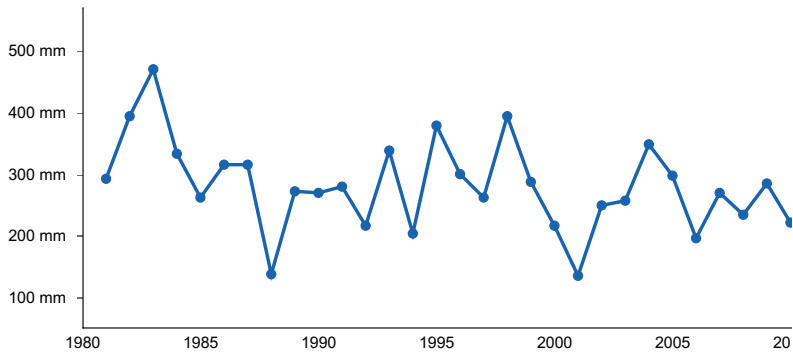

Figure 5. Annual precipitation pattern

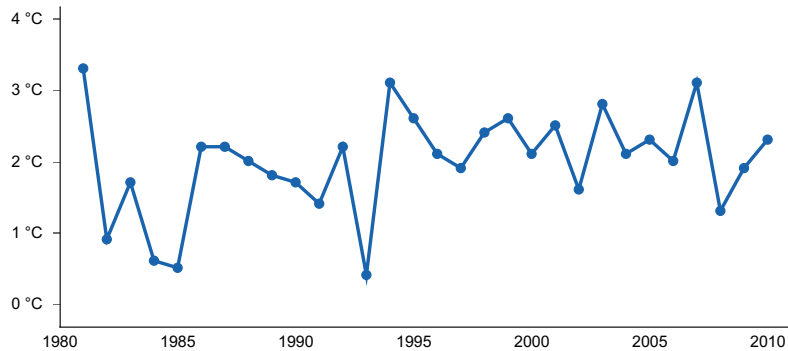

Figure 6. Annual average temperature pattern

Climate stations used

- (1) CORA [USC00482054], Cora, WY
- (2) PINEDALE [USC00487260], Pinedale, WY
- (3) BOULDER REARING STN [USC00480951], Boulder, WY

Influencing water features

There are no influencing water features.

Wetland description

N/A

Soil features

The soils of this site are shallow (10 to 20 inches) and formed in slope alluvium, colluvium and residuum derived from interbedded sandstone, sedimentary rock and conglomerate. Surface and subsurface textures are loamy coarse sand to fine sandy loam. Rock fragments are typically channery or flaggy (angular) and may be present at the surface with outcropping bedrock, increasing in volume with depth to lithic or paralithic contact. These soils are well-drained and have moderately rapid to rapid permeability.

The soil moisture regime is arctic ustic (ustic bordering on aridic) and the soil temperature regime is frigid bordering on cryic.

Major Soil Series correlated to this site include: Blackhall, Shaboom, Hooper, and Sanditch

Representative soil taxonomy:

Loamy, mixed, superactive, calcareous, frigid, shallow Ustic Torriorthents

Loamy-skeletal, mixed, superactive, frigid Lithic Haplustepts

Loamy, mixed, superactive, frigid, shallow Aridic Haplustalfs

Mixed, frigid Lithic Ustipsamments

Table 4. Representative soil features

Parent material	(1) Colluvium–sandstone (2) Slope alluvium–conglomerate (3) Residuum–sandstone
Surface texture	(1) Gravelly loamy coarse sand (2) Gravelly, channery, flaggy sandy loam (3) Channery, flaggy fine sandy loam
Family particle size	(1) Sandy-skeletal (2) Loamy-skeletal
Drainage class	Well drained
Permeability class	Moderately rapid to rapid
Depth to restrictive layer	25–51 cm
Soil depth	25–51 cm
Surface fragment cover ≤3"	0–25%
Surface fragment cover >3"	0–15%
Available water capacity (0-101.6cm)	1.78–5.33 cm
Calcium carbonate equivalent (0-15.2cm)	0–10%
Clay content (0-15.2cm)	8–18%
Electrical conductivity (0-50.8cm)	0–2 mmhos/cm
Sodium adsorption ratio (0-50.8cm)	0–3
Soil reaction (1:1 water) (0-50.8cm)	6.6–8.4
Subsurface fragment volume ≤3" (0-50.8cm)	0–30%
Subsurface fragment volume >3" (0-50.8cm)	0–20%

Ecological dynamics

A State-and-Transition Model (STM) diagram is depicted in this section. Narrative descriptions of each state, transition, plant community phase, and pathway are found after the model in this document. This diagram is based on available experimental research, field observations, professional consensus, logical extrapolations, and interpretations. While based on the best available information, the STM will change over time as knowledge of ecological processes increases. Although there is considerable qualitative experience supporting the pathways and transitions within the State-and-Transition Model, no quantitative information exists that specifically identifies threshold parameters between reference states and degraded states in this ecological site. For information on STMs, see the following citations: Bestelmeyer et.al. 2003, Bestelmeyer et.al. 2004, Bestelmeyer and Brown 2005, Briske et.al. 2008, and Stringham et.al. 2003.

Plant community composition within the same ecological site has a natural range of variability across the LRU due to the naturally occurring variability in weather, soils, and aspect. The biological processes on this site are complex; therefore, representative values are presented in a land management context. The species lists are representative and are not botanical descriptions of all species occurring, or potentially occurring, on this site. They are not intended to cover every situation or the full range of conditions, species, and responses for the site.

Both percent species composition by weight and percent cover are used in this ESD. Most observers find it easier to visualize or estimate percent cover for woody species (trees and shrubs). Foliar cover is used to define plant

community phases and states in the State-and-Transition Model. Cover drives the transitions between communities and states because of the influence of shade and interception of rainfall. Species composition by dry weight remains an important descriptor of the herbaceous community and of site productivity as a whole and includes both herbaceous and woody species. Calculating Similarity Index requires data on species composition by dry weight.

Not all managers will choose the Reference Plant Community as the management goal. Other plant communities may be desired to meet land management objectives. This is valid as long as the rangeland health attributes assessment departures are none to slight or slight to moderate from the Reference State as described in the Range Health Reference sheet.

A resource concern risk assessment and dominant resource concerns are provided for each Land Use, State, and/or Plant Community Phase based on NRCS resource concern and planning criteria used to determine resource treatment levels during the conservation planning process. A resource concern is a resource condition that does not meet the minimum accepted levels established by planning criteria as shown in Section III of the NRCS Field Office Technical Guide (<https://efotg.sc.egov.usda.gov/#/>).

- Low risk means a low probability for the category of resource concerns and additional assessment is typically not necessary.
- Medium risk means that the category of resource concerns could occur, and additional assessment is recommended if the identified resource is a client concern and/or objective.
- High risk means that a resource concern in that category is likely to occur.

The resource categories are: S (soil), W (water), A (air), P (plant), A (animal), E (energy), and H (human). The dominant resource concerns further refine the resource category to a specific resource concern within that category.

State and transition model

Land uses

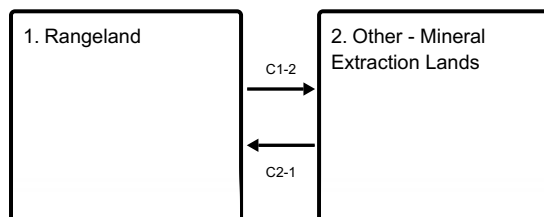

C1-2 - Vegetation and extreme soil disturbance (heavy equipment)

C2-1 - Re-shaping/re-contouring; topsoil replacement; seedbed preparation; seeding; weed and grazing management

Land use 1 submodel, ecosystem states

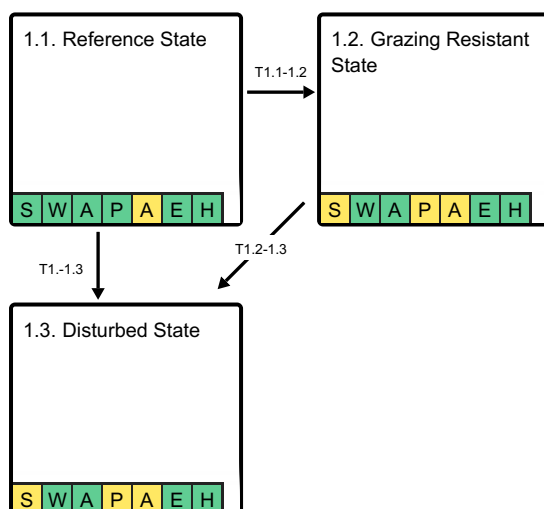

T1.1-1.2 - Herbivory pressure (moderate to high intensity continuous spring grazing or low intensity season-long grazing)

T1.-1.3 - Multiple soil disturbances and/or extreme herbivory combined with catastrophic drought

T1.2-1.3 - Multiple soil disturbances and/or extreme herbivory combined with catastrophic drought

State 1 submodel, plant communities

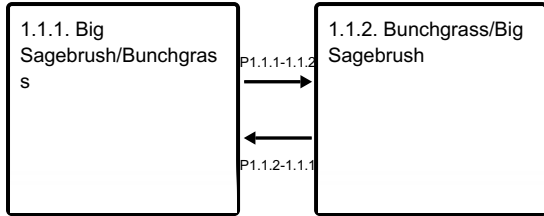

P1.1.1-1.1.2 - Sagebrush killing event (drought, freeze-kill, snow mold, herbivory, insects, disease)

P1.1.2-1.1.1 - Natural succession (time without sagebrush killing event)

State 2 submodel, plant communities

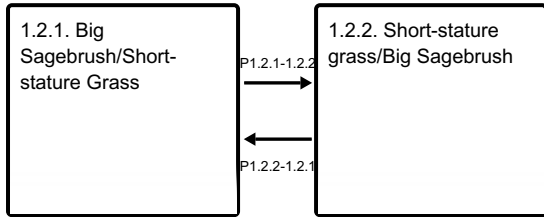

P1.2.1-1.2.2 - Sagebrush killing event (drought, prolonged soil saturation, freeze-kill, snow mold, herbivory, anthropogenic treatments)

P1.2.2-1.2.1 - Natural succession (time without a sagebrush killing event)

State 3 submodel, plant communities

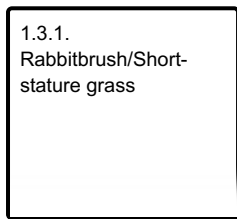

Land use 2 submodel, ecosystem states

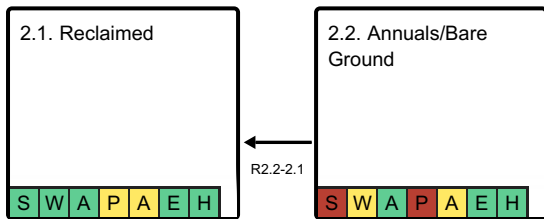

R2.2-2.1 - reclamation (re-contouring, seeding, mulching, prescribed grazing)

Land use 1 Rangeland

Range is the dominant land use for this site and provides the most diverse ecosystem services. Range is land on which the historic and introduced vegetation is predominantly grasses, grass-like plants, forbs or shrubs managed as a natural ecosystem. Range may include natural grasslands, savannas, shrublands, tundra, alpine communities, marshes and meadows.

Characteristics and indicators. This landuse consists of diverse native plant communities dominated by Wyoming big sagebrush and perennial cool season grasses that provide for site stability, hydrologic function, and biotic integrity of the site.

State 1.1 Reference State



Figure 7. Reference State

The Reference State consists of two plant communities: the Big Sagebrush/Bunchgrass community and the Bunchgrass/Big Sagebrush community. Each plant community differs in percent composition and foliar cover of bunchgrasses and shrubs. The dominant shrub is Wyoming big sagebrush. Dominant bunchgrasses include needle and thread, Indian ricegrass, and bluebunch wheatgrass. Forbs are a minor component. Two important processes occur in the reference state and result in plant community changes: 1) sagebrush-killing disturbances such as herbivory, drought, freeze-kill, snow mold, and to a lesser extent, fire; and 2) time without those disturbances, generally referred to as "natural succession." Fire is thought to have been infrequent due to low fine fuel loads, but when it occurred it was small acreage and stand replacing (Innes 2019). Fire Return Intervals are difficult to estimate due to little direct evidence of fire from pre-settlement times, but what information does exist suggests over 200 years for low fuel sites in the Wyoming Basin (Innes 2019).

Characteristics and indicators. The shift between plant community phases is dependent upon sagebrush-killing disturbances, and without them it will increase even with proper grazing management that includes light to moderate utilization, adequate recovery, and periodic critical growth period rest. Improper grazing management that includes high utilization, inadequate recovery, and continuous season-long grazing may accelerate the rate of increase for the shrub component. Management actions or treatments are not typically prescribed or used to mimic the natural disturbance regime due to fragile nature of the soils and lower productivity potential on this site. Treatments that do exist many times have goals for increased leader growth on shrubs for big game winter range. Prescribed fire is not used due to ownership patterns and lack of fine fuels (Clause and Randall, 2014).

Resilience management. This site has moderate to moderately high resilience due to its aridic ustic (ustic bordering on aridic) soil moisture regime and frigid bordering on cryic temperature regime (Chambers et.al. 2014). Precipitation is typically low, but more effective with cooler temperatures and present when needed during the critical growth period (May through June). The site can usually recover after minor disturbance but is susceptible to delays in recovery during extreme climatic events such as drought. The site has moderately high resistance to invasion by annual grasses because of climate limitations (dry and cold). The site may be susceptible to invasion after extreme disturbance during warmer climatic periods or on southeast aspects and concave microtopography. On a local scale, this site is more susceptible to annual weed invasion than sites with heavier soil textures.

Dominant plant species

- Wyoming big sagebrush (*Artemisia tridentata ssp. wyomingensis*), shrub
- needle and thread (*Hesperostipa comata*), grass
- Indian ricegrass (*Achnatherum hymenoides*), grass
- bluebunch wheatgrass (*Pseudoroegneria spicata*), grass

Dominant resource concerns

- Terrestrial habitat for wildlife and invertebrates
- Inadequate livestock water quantity, quality, and distribution

Community 1.1.1

Big Sagebrush/Bunchgrass

This plant community is well adapted to Cool Central Desertic Basins and Plateaus climatic conditions. The diversity in plant species allows for drought tolerance, and natural plant mortality is very low. Perennial plants that dominate this site have strong, healthy root systems that allow production to increase significantly with favorable moisture conditions. Abundant plant litter is available for soil building and moisture retention. Plant litter is properly distributed with very little movement off-site. This plant community provides for soil stability and a properly functioning hydrologic cycle. The Big Sagebrush/Bunchgrass Community can occur across the entire ecological site or can occur in a mosaic with the Bunchgrass/Big Sagebrush Community. This plant community occurs in the absence of sagebrush killing disturbances and with grazing that mimics the historic herbivory regime (light, episodic, and associate with mid-size ungulate migration). Wyoming big sagebrush is dominant with foliar cover ranging from 15% to 25%. At this sagebrush canopy level in this precipitation zone, there is some competition between the shrub over-story and the herbaceous under-story (Winward, 2007). A Big Sagebrush/Bunchgrass Community with a degraded under-story is an “at-risk” community that could transition to the Grazing Resistant State. There are some canopy gaps, but most are small (1-2 feet) with some moderate in size (3-6 feet). Rock cover on the soil surface is common and often armors the site against soil erosion. Many plant inter-spaces have canopy or litter cover. Production of grasses is lower than in the Bunchgrass/Big Sagebrush community.

Dominant plant species

- Wyoming big sagebrush (*Artemisia tridentata ssp. wyomingensis*), shrub
- bluebunch wheatgrass (*Pseudoroegneria spicata*), grass
- needle and thread (*Hesperostipa comata*), grass
- Indian ricegrass (*Achnatherum hymenoides*), grass

Table 5. Annual production by plant type

Plant Type	Low (Kg/Hectare)	Representative Value (Kg/Hectare)	High (Kg/Hectare)
Grass/Grasslike	247	340	432
Shrub/Vine	157	215	275
Forb	45	62	78
Total	449	617	785

Table 6. Soil surface cover

Tree basal cover	0%
Shrub/vine/liana basal cover	0-1%
Grass/grasslike basal cover	0-1%
Forb basal cover	0-1%
Non-vascular plants	0%
Biological crusts	1-2%
Litter	20-45%
Surface fragments >0.25" and <=3"	0-25%
Surface fragments >3"	0-15%
Bedrock	0-5%
Water	0%
Bare ground	20-40%

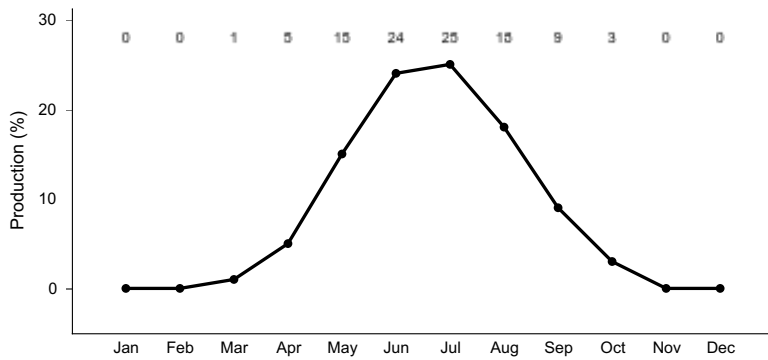

Figure 9. Plant community growth curve (percent production by month). WY34A02Xa, MLRA34A-Pinedale Plateau-all. Forage Production (herbaceous only) Developed by using the Rangeland Analysis Platform (RAP).

Community 1.1.2 Bunchgrass/Big Sagebrush

This plant community is well adapted to Cool Central Desertic Basins and Plateaus climatic conditions. The diversity in plant species allows for drought tolerance, and natural plant mortality is very low. Perennial plants that dominate this site have strong, healthy root systems that allow production to increase significantly with favorable moisture conditions. Abundant plant litter is available for soil building and moisture retention. Plant litter is properly distributed with very little movement off-site. This plant community provides for soil stability and a properly functioning hydrologic cycle. The Bunchgrass/Big Sagebrush Community can occur across the entire ecological site or can occur in a mosaic associated with the disturbance cycle at any given time and location with the Big Sagebrush/Bunchgrass Community. This plant community occurs after a recent sagebrush killing disturbances and with grazing that mimics the historic herbivory regime (light, episodic, and associate with mid-size ungulate migration). Mid-stature cool season bunchgrasses dominate and sagebrush is sub-dominant with foliar cover ranging from 5% to 15%. At this sagebrush canopy level in this precipitation zone, there is little, if any, competition between the shrub over-story and the herbaceous under-story. In fact, there is evidence to suggest that the under-story receives more benefit from the sage over-story than negative effects (Winward, 2007). There are some canopy gaps, but most are small (1-2 feet) with some moderate in size (3-6 feet). Rock cover on the soil surface is common and often armors the site against soil erosion. Many plant inter-spaces have canopy or litter cover. Production of grasses is higher than in the Big Sagebrush/Bunchgrass community.

Dominant plant species

- Wyoming big sagebrush (*Artemisia tridentata ssp. wyomingensis*), shrub
- needle and thread (*Hesperostipa comata*), grass
- Indian ricegrass (*Achnatherum hymenoides*), grass

Table 7. Annual production by plant type

Plant Type	Low (Kg/Hectare)	Representative Value (Kg/Hectare)	High (Kg/Hectare)
Grass/Grasslike	336	462	588
Shrub/Vine	67	93	118
Forb	45	62	78
Total	448	617	784

Table 8. Soil surface cover

Tree basal cover	0%
Shrub/vine/liana basal cover	0-1%
Grass/grasslike basal cover	0-1%
Forb basal cover	0-1%

Non-vascular plants	0%
Biological crusts	1-2%
Litter	20-45%
Surface fragments >0.25" and <=3"	10-20%
Surface fragments >3"	0-25%
Bedrock	0-5%
Water	0%
Bare ground	20-40%

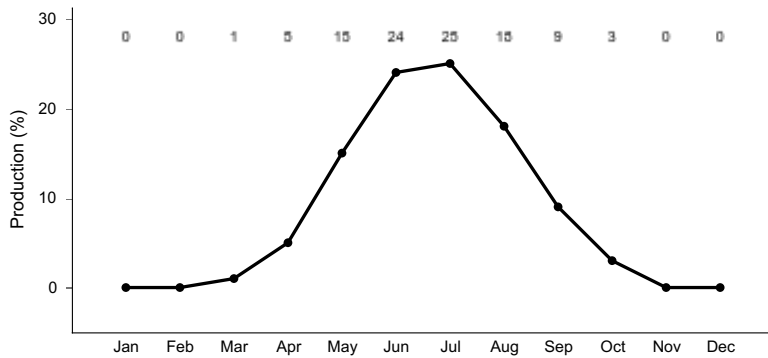

Figure 11. Plant community growth curve (percent production by month). WY34A02Xa, MLRA34A-Pinedale Plateau-all. Forage Production (herbaceous only) Developed by using the Rangeland Analysis Platform (RAP).

Pathway P1.1.1-1.1.2 Community 1.1.1 to 1.1.2

This pathway occurs after a sagebrush killing event, such as drought, freeze-kill, snow mold and/or herbivory, insects or disease. Fire is infrequent on this site due to low fine fuel loads.

Context dependence. This pathway relies upon close to normal precipitation and temperature as well as a grazing regime that is low to moderate intensity. If extreme conditions/disturbances such as hot temperatures, drought, catastrophic fire, or high intensity grazing occur, there is risk of a transition to either the Grazing Resistant or Disturbed State depending upon severity and cumulative disturbance. A successful pathway is contingent upon a grazing regime that allows for periodic critical growth period rest (May-June). The historic herbivory regime was light and episodic, sometimes including spring/fall migration patterns by mid-size ungulates who "ride the green wave" from winter to summer ranges (Aikens et.al. 2017).

Conservation practices

Prescribed Grazing

Pathway P1.1.2-1.1.1 Community 1.1.2 to 1.1.1

Natural succession (time without a sagebrush killing event).

Context dependence. The time period for this pathway is dependent upon weather events such as drought and above normal precipitation years. Drought results in a slower pathway while favorable precipitation can result in a faster pathway. A grazing regime that mimics the historic regime (light intensity, episodic grazing events) will not alter the pathway, but a continuous grazing regime at moderate to heavy intensity can accelerate the pathway and puts the plant community at-risk of transitioning to the Grazing Resistant State if maintained over long periods of time.

State 1.2 Grazing Resistant State



Figure 12. Grazing Resistant State

The Grazing Resistant State consists of two plant communities: the Big Sagebrush/Short-stature Grass community and the Short-stature Grass/Big Sagebrush community. There has been a shift in understory functional/structural group dominance. Due to herbivory pressure or possibly catastrophic drought, there is a shift from mid-stature cool-season bunchgrasses to short-stature cool-season bunchgrasses, rhizomatous wheatgrasses, and grass-like. Canopy gap interspace and bare ground has increased from the Reference State, while herbaceous foliar cover has decreased.

Characteristics and indicators. There are fewer mid-size bunchgrasses and they are typically found under the shrub canopy where they are protected from herbivory. The shrub canopy inter-spaces are occupied by grazing tolerant grasses as well as patches of bare ground that are often connected. Drier site conditions result in lower productivity and less herbaceous production potential. In many cases, the transition to the Grazing Resistant State may have occurred many decades ago during an era of higher stocking rates and continuous grazing during the growing season. However, continual grazing during the critical growth period (roughly May through June) at proper stocking rates will facilitate the transition to this state or maintain it as a stable state.

Resilience management. Site resilience is lower than the Reference State. Site hydrology has been modified due to moisture being utilized by shallower rooting species. Therefore, the site is drier earlier in the season, lower in diversity, and unable to recover as quickly after a disturbance such as drought. This state is more drought-prone, and therefore sees wider productivity swings during dry versus wet years. Site resistance to invasion by annual grasses is similar to the reference state, although there are more niches for undesirable annual forbs such as desert alysium or annual invasive grasses such as cheatgrass to become established during favorable (hot/dry) conditions on southeastern aspects and concave micro-topography.

Dominant plant species

- Wyoming big sagebrush (*Artemisia tridentata* ssp. *wyomingensis*), shrub
- Sandberg bluegrass (*Poa secunda*), grass
- thickspike wheatgrass (*Elymus lanceolatus* ssp. *lanceolatus*), grass
- needleleaf sedge (*Carex duriuscula*), other herbaceous

Dominant resource concerns

- Sheet and rill erosion
- Wind erosion
- Classic gully erosion
- Plant productivity and health
- Plant structure and composition
- Plant pest pressure
- Terrestrial habitat for wildlife and invertebrates
- Feed and forage imbalance
- Inadequate livestock water quantity, quality, and distribution

Community 1.2.1

Big Sagebrush/Short-stature Grass

This plant community is characterized as Wyoming big sagebrush dominated with a diminished understory. The understory has lost many of the mid-stature cool-season bunchgrasses, and they have been replaced with short-stature bunchgrasses such as Sandberg bluegrass, rhizomatous wheatgrasses and grass-likes, and mat-forming forbs. Shrub foliar cover is often greater than 15 percent and typically comprising greater than 30 percent of total annual production (species composition by dry weight). Areas that catch and retain snow are more likely to have higher shrub cover. Herbaceous production and foliar cover has decreased. A small amount of annual invasive grasses such as cheatgrass could occur on south aspects, mostly less than five percent foliar cover. There is often a slight increase in sprouting shrubs (less than 10 percent composition by weight). The site is typically adequately protected from soil erosion due to surface rock fragments and high sage cover. Hydrologic Function has been altered through higher than normal sagebrush canopy. Biotic Integrity is reduced due to low vegetative production, relative dominance of structural/functional groups, and potentially invasive species if present. Total annual production ranges from 200 to 600 pounds per acre with a Representative Value (RV) of 400 pounds per acre. Productivity is highly variable and fluctuates drastically in response to drought and wet cycles.

Dominant plant species

- Wyoming big sagebrush (*Artemisia tridentata ssp. wyomingensis*), shrub
- thickspike wheatgrass (*Elymus lanceolatus ssp. lanceolatus*), grass
- needleleaf sedge (*Carex duriuscula*), grass

Community 1.2.2

Short-stature grass/Big Sagebrush

This plant community is characterized by a dominance of short-stature grasses such as Sandberg bluegrass, rhizomatous grasses and grass-likes, and mat-forming forbs. A sagebrush killing event has happened recently, and Wyoming big sagebrush foliar cover is typically less than 15 percent. A small amount of annual invasive grasses such as cheatgrass could occur on south aspects, mostly less than five percent foliar cover. There is often a slight increase in bare ground. The site is typically adequately protected from soil erosion due to surface rock fragments and high sage cover. Hydrologic Function has been altered through increased bare ground. Biotic Integrity is reduced due to low vegetative production, relative dominance of structural/functional groups, and potentially invasive species if present. Total annual production ranges from 200 to 600 pounds per acre with a Representative Value (RV) of 400 pounds per acre. Productivity is highly variable and fluctuates drastically in response to drought and wet cycles. This plant community is at-risk of transitioning to the Disturbed State with additional disturbance such as heavy grazing, sagebrush treatment, or ground-disturbing activity.

Dominant plant species

- Wyoming big sagebrush (*Artemisia tridentata ssp. wyomingensis*), shrub
- thickspike wheatgrass (*Elymus lanceolatus ssp. lanceolatus*), grass
- needleleaf sedge (*Carex duriuscula*), grass

Pathway P1.2.1-1.2.2

Community 1.2.1 to 1.2.2

Sagebrush killing event, mainly natural and climatic events such as herbivory, drought, prolonged soil saturation, freeze-kill, or snow mold. Fire is not typically a driver in this state due to the lack of fine fuels in the under-story. Anthropogenic sagebrush treatments is another potential drivers, but is not common on this site.

Context dependence. If extreme conditions/disturbances such as hot temperatures, drought, or high intensity grazing occur, there is risk of a transition to the Disturbed State depending upon severity and cumulative disturbance. Prolonged drought and improper grazing (high intensity, season-long) can accelerate the pathway back to a sagebrush dominated plant community.

Conservation practices

Pathway P1.2.2-1.2.1 Community 1.2.2 to 1.2.1

Natural succession (time without a sagebrush killing event).

Context dependence. The time period for this pathway is dependent upon weather events such as drought and above normal precipitation years. Drought results in a faster pathway while favorable precipitation can result in a slower pathway. A grazing regime that mimics the historic regime (light intensity, episodic grazing events) will not alter the pathway, but a continuous grazing regime at moderate to heavy intensity can accelerate the pathway.

State 1.3 Disturbed State

The disturbed state is a result of soil-disturbing activities outside of the normal disturbance regime expected for this site. Examples are high intensity hoof action, anthropogenic activity, rodent activity, or frequent flooding, which includes occasional irrigation. It may also occur after brush management (or multiple consecutive treatments) preceded or followed by improper grazing techniques that include high-intensity grazing use without appropriate recovery periods.

Characteristics and indicators. There is a shift toward sprouting shrub dominance and increased bare ground with diminished under-story and litter. Both green (*Chrysothamnus viscidiflorus*) and rubber rabbitbrush (*Ericameria nauseosa*) may be present. Along with a shift in shrub species, the herbaceous under-story also shifts toward more disturbance tolerant species such as thickspike wheatgrass (*Elymus lanceolatus* ssp. *lanceolatus*) and needleleaf sedge (*Carex duriuscula*). Annual weeds such as bur buttercup (*Ceratocephala testiculata*), flixweed (*Descurainia sophia*), and lambsquarter (*Chenopodium album*), and invasive annual grasses such as cheatgrass (*Bromus tectorum*) can be present in small amounts (less than five percent composition by dry weight).

Resilience management. Site resilience is lower than the Reference State or Grazing Resistant State. Site hydrology has been modified due to moisture being utilized by shallower rooting species. Therefore, the site is drier earlier in the season and unable to recover as quickly after a disturbance. However, existing shrub canopy and remnant perennial vegetation provide some amount of resiliency. Site resistance to invasion by annual grasses is lower due to niches in the understory for establishment as well as coarse soil surface textures. Episodic moisture is more suited to annual life forms during drought.

Dominant plant species

- yellow rabbitbrush (*Chrysothamnus viscidiflorus*), shrub
- rubber rabbitbrush (*Ericameria nauseosa*), shrub
- thickspike wheatgrass (*Elymus lanceolatus* ssp. *lanceolatus*), grass
- needleleaf sedge (*Carex duriuscula*), other herbaceous

Dominant resource concerns

- Sheet and rill erosion
- Wind erosion
- Classic gully erosion
- Plant productivity and health
- Plant structure and composition
- Plant pest pressure
- Terrestrial habitat for wildlife and invertebrates
- Feed and forage imbalance
- Inadequate livestock water quantity, quality, and distribution

Community 1.3.1 Rabbitbrush/Short-stature grass

Rabbitbrush dominates with foliar cover often exceeding 20 percent, typically making up over 30 percent of total annual production (species composition by dry weight). Short-stature perennial grasses such as thickspike wheatgrass and needleleaf sedge are dominant. Annual grasses or forbs are more common on southeastern aspects and concave microtopography. Common annuals include desert alyssum, flixweed, and occasionally cheatgrass if a seed source has been introduced to the site. The understory has decreased and bare ground exceeds 40 percent. Bunchgrasses are limited to the protected areas under shrubs. The site is typically adequately protected, but wind erosion can occur, resulting in scouring and deposition. Biotic Integrity is reduced due to low vegetative production, relative dominance and unexpected structural/functional groups, and potentially invasive species if present. Total annual production ranges from 100 to 400 pounds per acre with a Representative Value (RV) of 200 pounds per acre.

Transition T1.1-1.2 **State 1.1 to 1.2**

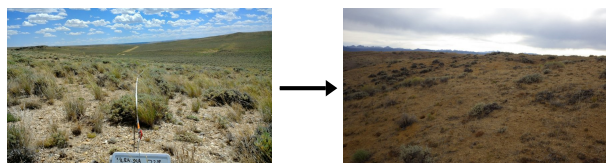

Reference State

Grazing Resistant State

Herbivory pressure in excess of normal Reference State conditions. Typical scenarios include moderate to high intensity continuous spring grazing or low intensity season-long grazing.

Constraints to recovery. Recovery is inhibited by continued herbivory pressure, reduced seedbank, and drought conditions. Annual grasses may occur in small amounts when on southeast aspects and concave microtopography.

Context dependence. Warmer and drier climate trends contribute to uncertainty of restoration efforts. Coarse soil textures put this site at risk of transitioning to the Disturbed State with continued or additive disturbances.

Transition T1.-1.3 **State 1.1 to 1.3**

Soil-disturbance outside of the normal disturbance regime expected for this site. Examples include high intensity fire, high intensity hoof action, anthropogenic activity (e.g. mechanical and chemical treatments), recreational activities, or rodent activity. Extreme herbivory in combination with catastrophic drought may be a trigger for this transition as well.

Constraints to recovery. Persistent drought conditions, and herbivory pressure are constraints to recovery to the Reference State. Recovery is further inhibited by consecutive disturbances repeated over a relatively short time period and prolonged drought conditions. There is a risk of annual invasion on southeastern aspects and concave micro-topography.

Context dependence. This transition typically occurs after multiple consecutive disturbances. Warmer and drier climate trends contribute to uncertainty of restoration efforts.

Transition T1.2-1.3 **State 1.2 to 1.3**

Soil-disturbance outside of the normal disturbance regime expected for this site. Examples include high intensity fire, high intensity hoof action, anthropogenic activity (e.g. mechanical and chemical treatments), rodent activity, or prolonged soil saturation, typically occasional irrigation. Extreme herbivory in combination with catastrophic drought may be a trigger for this transition as well.

Constraints to recovery. Persistent drought conditions, and herbivory pressure are constraints to recovery to the Reference State. Recovery is further inhibited by consecutive disturbances repeated over a relatively short time period and prolonged drought conditions. There is a risk of annual invasion on southeastern aspects and concave

microtopography.

Context dependence. This transition typically occurs after multiple consecutive disturbances. Warmer and drier climate trends contribute to uncertainty of restoration efforts.

Land use 2

Other - Mineral Extraction Lands

Land that is barren, sandy, rocky, or that is impacted by the extraction of natural resources, such as minerals, gravel or sand, coal, shale, rock, oil, or natural gas.

Characteristics and indicators. This land use can be many things, but in this LRU is most often associated with oil and gas development. Barren land. A land cover/use category used to classify lands with limited capacity to support life and having less than 5 percent vegetative cover. Vegetation, if present, is widely spaced. [NRI-87] Typically, the surface of barren land is sand, rock, exposed subsoil, or salt-affected soils. Subcategories include salt flats; sand dunes; mud flats; beaches; bare exposed rock; quarries, strip mines, gravel pits, and borrow pits; river wash; oil wasteland; mixed barren lands; and other barren land. [NRI-92]

State 2.1

Reclaimed

The Reclaimed State is highly variable based on weather conditions during reclamation activities, the management practices used to implement the reclamation, the seed mix, and timing/method of stockpiling topsoil during the disturbance.

Characteristics and indicators. The most common scenario is a reclaimed oil and gas well pad planted to crested wheatgrass (*Agropyron cristatum*) without appropriate topsoil stockpiling. If topsoil is stockpiled, it may have been stored for too long and/or stored too deep resulting in fewer soil microorganisms. Over time, Wyoming big sagebrush will spread into the reclaimed area, but the understory will be dominated by introduced species. Biological soil crusts are minimal, further exposing the soil surface to erosional forces as well as impairing carbon, nutrient, and water cycles.

Resilience management. Resilience is lower than the Reference State, but with best management practices, a certain amount of resilience can be restored. Successful reclamation will result in reduced soil erosion and improved hydrologic function. Biotic integrity is highly variable. Because soil disturbance previously occurred on the site and soil surface textures are coarse, resistance to invasive species is low.

Dominant resource concerns

- Plant structure and composition
- Plant pest pressure
- Terrestrial habitat for wildlife and invertebrates
- Inadequate livestock water quantity, quality, and distribution

State 2.2

Annuals/Bare Ground

The Annuals/*Bare Ground* community occurs after severe disturbance, most often physical soil disturbance that removes topsoil, but it can also occur as a transition from the Eroded State after severe drought, flooding, pests, or disease, leaving the site with no perennial vegetation.

Characteristics and indicators. Populations of annual weedy forbs can reach critical levels and impact the ecological processes on the site until restoration or reclamation of the site occurs. As part of succession, all sites that are severely disturbed go through this plant community as part of the restoration process, but the time in this plant community phase is largely dependent on the use of restoration Best Management Practices (BPMs) and climate cycles. Biological soil crusts are non-existent, further exposing the soil surface to erosional forces as well as impairing carbon, nutrient, and water cycles.

Resilience management. Site resilience is at its lowest, and recovery is largely dependent on management

practices and weather patterns. Resistance to invasion is at its lowest, and the site is vulnerable to all of the common annual weedy forbs such as Russian thistle (*Salsola tragus*), flixweed (*Descurainia sophia*), lambsquarter (*Chenopodium album*), and halogeton (Halogeton glomeratus) as well as invading species such as cheatgrass (*Bromus tectorum*) and existing or newly emerging noxious weed threats.

Dominant resource concerns

- Sheet and rill erosion
- Wind erosion
- Classic gully erosion
- Sediment transported to surface water
- Plant productivity and health
- Plant structure and composition
- Plant pest pressure
- Inadequate livestock water quantity, quality, and distribution

Restoration pathway R2.2-2.1

State 2.2 to 2.1

Reclamation efforts include re-seeding. In cases where heavy equipment caused the disturbance, contouring and/or deep ripping may be necessary to provide a suitable site for re-seeding. Care must be taken to stockpile and replace surface layers separately from the subsurface. Prescribed grazing and restricting vehicle traffic on the site is necessary to facilitate successful seeding of perennial species.

Context dependence. Drought conditions and/or herbivory pressure may hinder restoration efforts, and multiple seeding efforts may be necessary if failure is caused by drought. Mulch can be effective for soil moisture retention and erosion control. Soil limitations include depth and care must be used to stockpile soil surface for later use in site reclamation and restoration.

Conservation practices

Critical Area Planting
Mulching
Prescribed Grazing

Conversion C1-2

Land use 1 to 2

The conversion from Range to Other - Mineral Extraction Lands occurs when vegetation and soil is manipulated for the purpose of mineral extraction. Common practices are oil and natural gas pad and pipeline infrastructure, gravel pits, and road construction. Vegetation and topsoil is removed and topsoil is often stockpiled for on or off-site reclamation.

Conversion C2-1

Land use 2 to 1

Conversion from Other - Mineral Extraction Lands to Range occurs, sometimes over a long period of time, as part of the restoration process after mineral extraction. There is low potential for recovery without significant inputs of energy and resources, especially if topsoil has been removed. Seed mixes that mimic an adjacent “reference area” rather than the site potential as described in the Reference State (1.1) will often result in a plant community resembling the Grazing Resistant State (1.2) due to inappropriate seed mixes and pre- and post-seeding grazing management that does not provide adequate recovery and periodic critical growth period rest.

Additional community tables

Table 9. Community 1.1 plant community composition

Group	Common Name	Symbol	Scientific Name	Annual Production (Kg/Hectare)	Foliar Cover (%)
-------	-------------	--------	-----------------	--------------------------------	------------------

Grass/Grasslike					
1	Perennial Mid-Size Cool Season Bunchgrasses			123–247	
	bluebunch wheatgrass	PSSP6	<i>Pseudoroegneria spicata</i>	31–185	5–25
	needle and thread	HECO26	<i>Hesperostipa comata</i>	62–185	10–20
	Indian ricegrass	ACHY	<i>Achnatherum hymenoides</i>	7–123	1–10
	Letterman's needlegrass	ACLE9	<i>Achnatherum lettermanii</i>	7–62	1–10
	Montana wheatgrass	ELAL7	<i>Elymus albicans</i>	0–62	0–10
	squirreltail	ELEL5	<i>Elymus elymoides</i>	0–62	0–10
	slender wheatgrass	ELTR7	<i>Elymus trachycaulus</i>	0–31	0–5
	muttongrass	POFE	<i>Poa fendleriana</i>	0–31	0–5
2	Rhizomatous Grasses			31–62	
	thickspike wheatgrass	ELLAL	<i>Elymus lanceolatus ssp. lanceolatus</i>	31–62	5–10
	western wheatgrass	PASM	<i>Pascopyrum smithii</i>	31–62	5–10
3	Misc Grasses/Grass-likes			12–31	
	needleleaf sedge	CADU6	<i>Carex duriuscula</i>	7–31	1–5
	prairie Junegrass	KOMA	<i>Koeleria macrantha</i>	0–31	0–5
	spike fescue	LEK12	<i>Leucopoa kingii</i>	0–31	0–5
	Sandberg bluegrass	POSE	<i>Poa secunda</i>	7–31	1–5
	Grass, perennial	2GP	<i>Grass, perennial</i>	0–31	0–5
	blue grama	BOGR2	<i>Bouteloua gracilis</i>	0–19	0–3
	plains reedgrass	CAMO	<i>Calamagrostis montanensis</i>	0–7	0–1
Forb					
4	Perennial Forbs			31–56	
	buckwheat	ERIOG	<i>Eriogonum</i>	7–31	1–5
	lupine	LUPIN	<i>Lupinus</i>	7–31	1–5
	spiny phlox	PHHO	<i>Phlox hoodii</i>	7–31	1–5
	longleaf phlox	PHLO2	<i>Phlox longifolia</i>	0–19	0–3
	flaxleaf plainsmustard	SCLI	<i>Schoenocrambe linifolia</i>	0–19	0–3
	locoweed	OXYTR	<i>Oxytropis</i>	0–19	0–3
	beardtongue	PENST	<i>Penstemon</i>	0–19	0–3
	hoary tansyaster	MACA2	<i>Machaeranthera canescens</i>	0–19	0–3
	bluebells	MERTE	<i>Mertensia</i>	0–19	0–3
	tapertip hawksbeard	CRAC2	<i>Crepis acuminata</i>	0–19	0–3
	milkvetch	ASTRA	<i>Astragalus</i>	0–19	0–3
	western yarrow	ACMIO	<i>Achillea millefolium var. occidentalis</i>	0–19	0–3
	scarlet globemallow	SPCO	<i>Sphaeralcea coccinea</i>	0–19	0–3
	stemless mock goldenweed	STAC	<i>Stenotus acaulis</i>	0–19	0–3
	aster	SYMPH4	<i>Symphyotrichum</i>	0–19	0–3
	fleabane	ERIGE2	<i>Erigeron</i>	0–19	0–3
	Townsend daisy	TOWNS	<i>Townsendia</i>	0–7	0–1
	clover	TRIFO	<i>Trifolium</i>	0–7	0–1
	violet	VIOLA	<i>Viola</i>	0–7	0–1

	VIOL	VIOLA	viola	0-7	0-1
	deathcamas	ZIGAD	<i>Zigadenus</i>	0-7	0-1
	Forb, perennial	2FP	<i>Forb, perennial</i>	0-7	0-1
	agoseris	AGOSE	<i>Agoseris</i>	0-7	0-1
	onion	ALLIU	<i>Allium</i>	0-7	0-1
	pussytoes	ANTEN	<i>Antennaria</i>	0-7	0-1
	rockcross	ARABI2	<i>Arabis</i>	0-7	0-1
	sandwort	ARENA	<i>Arenaria</i>	0-7	0-1
	Indian paintbrush	CASTI2	<i>Castilleja</i>	0-7	0-1
	Douglas' dustymaiden	CHDO	<i>Chaenactis douglasii</i>	0-7	0-1
	pale bastard toadflax	COUMP	<i>Comandra umbellata ssp. pallida</i>	0-7	0-1
	cryptantha	CRYPT	<i>Cryptantha</i>	0-7	0-1
	larkspur	DELPH	<i>Delphinium</i>	0-7	0-1
	evening primrose	OENOT	<i>Oenothera</i>	0-7	0-1
	western wallflower	ERAS2	<i>Erysimum asperum</i>	0-7	0-1
	bladderpod	LESQU	<i>Lesquerella</i>	0-7	0-1
	desertparsley	LOMAT	<i>Lomatium</i>	0-7	0-1
	phacelia	PHACE	<i>Phacelia</i>	0-7	0-1
	nailwort	PARON	<i>Paronychia</i>	0-7	0-1
	spearleaf stonecrop	SELA	<i>Sedum lanceolatum</i>	0-7	0-1
5	Annual Forbs			0-7	
	rockjasmine	ANDRO3	<i>Androsace</i>	0-7	0-1
	bushy bird's beak	CORA5	<i>Cordylanthus ramosus</i>	0-7	0-1
	cryptantha	CRYPT	<i>Cryptantha</i>	0-7	0-1
	groundsmoke	GAYOP	<i>Gayophytum</i>	0-7	0-1
	flatspine stickseed	LAOC3	<i>Lappula occidentalis</i>	0-7	0-1
	Forb, annual	2FA	<i>Forb, annual</i>	0-7	0-1
Shrub/Vine					
6	Sagebrush			93-185	
	Wyoming big sagebrush	ARTRW8	<i>Artemisia tridentata ssp. wyomingensis</i>	93-185	15-25
	mountain big sagebrush	ARTRV	<i>Artemisia tridentata ssp. vaseyana</i>	0-185	0-15
	prairie sagewort	ARFR4	<i>Artemisia frigida</i>	0-19	0-3
7	Miscellaneous Shrubs			12-31	
	yellow rabbitbrush	CHVI8	<i>Chrysothamnus viscidiflorus</i>	7-31	1-5
	rubber rabbitbrush	ERNA10	<i>Ericameria nauseosa</i>	0-31	0-5
	antelope bitterbrush	PUTR2	<i>Purshia tridentata</i>	0-31	0-5
	Woods' rose	ROWOW	<i>Rosa woodsii var. woodsii</i>	0-19	0-3
	greasewood	SAVE4	<i>Sarcobatus vermiculatus</i>	0-19	0-3
	spineless horsebrush	TECA2	<i>Tetradymia canescens</i>	0-19	0-3
	shortspine horsebrush	TESP2	<i>Tetradymia spinosa</i>	0-19	0-3
	broom snakeweed	GUSA2	<i>Gutierrezia sarothrae</i>	0-19	0-3
	Utah juniper	JUOS	<i>Juniperus osteosperma</i>	0-19	0-3
	winterfat	KRLA2	<i>Krascheninnikovia lanata</i>	0-19	0-3
	granite pinky chlo...	LIDU14	<i>Limonium</i>	0-19	0-3

	granite prickly phlox	LIF011	<i>Linnanthus pungens</i>	0-19	0-3
	plains pricklypear	OPPO	<i>Opuntia polyacantha</i>	0-7	0-1
	Shrub (>.5m)	2SHRUB	<i>Shrub (>.5m)</i>	0-7	0-1
	Gardner's saltbush	ATGA	<i>Atriplex gardneri</i>	0-7	0-1

Table 10. Community 1.2 plant community composition

Group	Common Name	Symbol	Scientific Name	Annual Production (Kg/Hectare)	Foliar Cover (%)
Grass/Grasslike					
1	Perennial Mid-Size Cool Season Bunchgrasses			185-370	
	bluebunch wheatgrass	PSSP6	<i>Pseudoroegneria spicata</i>	31-247	5-35
	needle and thread	HECO26	<i>Hesperostipa comata</i>	123-247	20-35
	Indian ricegrass	ACHY	<i>Achnatherum hymenoides</i>	31-185	5-20
	Montana wheatgrass	ELAL7	<i>Elymus albicans</i>	0-123	0-20
	Letterman's needlegrass	ACLE9	<i>Achnatherum lettermanii</i>	7-93	1-15
	squirreltail	ELEL5	<i>Elymus elymoides</i>	0-62	0-10
	slender wheatgrass	ELTR7	<i>Elymus trachycaulus</i>	0-31	0-5
	muttongrass	POFE	<i>Poa fendleriana</i>	0-31	0-5
	Sandberg bluegrass	POSE	<i>Poa secunda</i>	0-31	0-5
2	Rhizomatous Grasses			31-62	
	thickspike wheatgrass	ELLAL	<i>Elymus lanceolatus ssp. lanceolatus</i>	31-62	5-10
	western wheatgrass	PASM	<i>Pascopyrum smithii</i>	31-62	5-10
3	Miscellaneous Grasses/Grasslikes			12-31	
	needleleaf sedge	CADU6	<i>Carex duriuscula</i>	7-31	1-5
	prairie Junegrass	KOMA	<i>Koeleria macrantha</i>	0-31	0-5
	spike fescue	LEKI2	<i>Leucopoa kingii</i>	0-31	0-5
	Sandberg bluegrass	POSE	<i>Poa secunda</i>	7-31	1-5
	Grass, perennial	2GP	<i>Grass, perennial</i>	0-31	0-5
	blue grama	BOGR2	<i>Bouteloua gracilis</i>	0-19	0-3
	plains reedgrass	CAMO	<i>Calamagrostis montanensis</i>	0-7	0-1
Forb					
4	Perennial Forbs			31-56	
	buckwheat	ERIOG	<i>Eriogonum</i>	7-31	1-5
	lupine	LUPIN	<i>Lupinus</i>	0-31	0-5
	spiny phlox	PHHO	<i>Phlox hoodii</i>	7-31	1-5
	longleaf phlox	PHLO2	<i>Phlox longifolia</i>	0-19	0-3
	flaxleaf plainsmustard	SCLI	<i>Schoenocrambe linifolia</i>	0-19	0-3
	scarlet globemallow	SPCO	<i>Sphaeralcea coccinea</i>	0-19	0-3
	stemless mock goldenweed	STAC	<i>Stenotus acaulis</i>	0-19	0-3
	aster	SYMPH4	<i>Symphotrichum</i>	0-19	0-3
	hoary tansyaster	MACA2	<i>Machaeranthera canescens</i>	0-19	0-3
	bluebells	MERTE	<i>Mertensia</i>	0-19	0-3
	locoweed	OXYTR	<i>Oxytropis</i>	0-19	0-3
	beardtongue	DENST	<i>Penstemon</i>	0-19	0-3

	fleabane	ERIGE2	<i>Erigeron</i>	0-19	0-3
	tapertip hawksbeard	CRAC2	<i>Crepis acuminata</i>	0-19	0-3
	milkvetch	ASTRA	<i>Astragalus</i>	0-19	0-3
	western yarrow	ACMIO	<i>Achillea millefolium var. occidentalis</i>	0-19	0-3
	agoseris	AGOSE	<i>Agoseris</i>	0-7	0-1
	onion	ALLIU	<i>Allium</i>	0-7	0-1
	pussytoes	ANTEN	<i>Antennaria</i>	0-7	0-1
	rockcress	ARABI2	<i>Arabis</i>	0-7	0-1
	sandwort	ARENA	<i>Arenaria</i>	0-7	0-1
	Indian paintbrush	CASTI2	<i>Castilleja</i>	0-7	0-1
	Douglas' dustymaiden	CHDO	<i>Chaenactis douglasii</i>	0-7	0-1
	pale bastard toadflax	COUMP	<i>Comandra umbellata ssp. pallida</i>	0-7	0-1
	cryptantha	CRYPT	<i>Cryptantha</i>	0-7	0-1
	larkspur	DELPH	<i>Delphinium</i>	0-7	0-1
	western wallflower	ERAS2	<i>Erysimum asperum</i>	0-7	0-1
	bladderpod	LESQU	<i>Lesquerella</i>	0-7	0-1
	desertparsley	LOMAT	<i>Lomatium</i>	0-7	0-1
	phacelia	PHACE	<i>Phacelia</i>	0-7	0-1
	nailwort	PARON	<i>Paronychia</i>	0-7	0-1
	evening primrose	OENOT	<i>Oenothera</i>	0-7	0-1
	Townsend daisy	TOWNS	<i>Townsendia</i>	0-7	0-1
	clover	TRIFO	<i>Trifolium</i>	0-7	0-1
	violet	VIOLA	<i>Viola</i>	0-7	0-1
	deathcamas	ZIGAD	<i>Zigadenus</i>	0-7	0-1
	Forb, perennial	2FP	<i>Forb, perennial</i>	0-7	0-1
	spearleaf stonecrop	SELA	<i>Sedum lanceolatum</i>	0-7	0-1
5	Annual Forbs			0-7	
	rockjasmine	ANDRO3	<i>Androsace</i>	0-7	0-1
	bushy bird's beak	CORA5	<i>Cordylanthus ramosus</i>	0-7	0-1
	cryptantha	CRYPT	<i>Cryptantha</i>	0-7	0-1
	groundsmoke	GAYOP	<i>Gayophytum</i>	0-7	0-1
	flatspine stickseed	LAOC3	<i>Lappula occidentalis</i>	0-7	0-1
	Forb, annual	2FA	<i>Forb, annual</i>	0-7	0-1
Shrub/Vine					
6	Sagebrush			31-62	
	Wyoming big sagebrush	ARTRW8	<i>Artemisia tridentata ssp. wyomingensis</i>	31-62	5-15
	mountain big sagebrush	ARTRV	<i>Artemisia tridentata ssp. vaseyana</i>	0-62	0-15
	prairie sagewort	ARFR4	<i>Artemisia frigida</i>	0-19	0-3
7	Miscellaneous Shrubs			12-31	
	antelope bitterbrush	PUTR2	<i>Purshia tridentata</i>	0-31	0-5
	yellow rabbitbrush	CHVI8	<i>Chrysothamnus viscidiflorus</i>	7-31	1-5
	rubber rabbitbrush	ERNA10	<i>Ericameria nauseosa</i>	0-31	0-5

	broom snakeweed	GUSA2	<i>Gutierrezia sarothrae</i>	0-19	0-3
	Utah juniper	JUOS	<i>Juniperus osteosperma</i>	0-19	0-3
	winterfat	KRLA2	<i>Krascheninnikovia lanata</i>	0-19	0-3
	granite prickly phlox	LIPU11	<i>Linanthus pungens</i>	0-19	0-3
	Woods' rose	ROWOW	<i>Rosa woodsii</i> var. <i>woodsii</i>	0-19	0-3
	greasewood	SAVE4	<i>Sarcobatus vermiculatus</i>	0-19	0-3
	spineless horsebrush	TECA2	<i>Tetradymia canescens</i>	0-19	0-3
	shortspine horsebrush	TESP2	<i>Tetradymia spinosa</i>	0-19	0-3
	Shrub (>.5m)	2SHRUB	<i>Shrub (>.5m)</i>	0-7	0-1
	Gardner's saltbush	ATGA	<i>Atriplex gardneri</i>	0-7	0-1
	plains pricklypear	OPPO	<i>Opuntia polyacantha</i>	0-7	0-1

Animal community

The following table lists initial suggested stocking rates for cattle under continuous season-long grazing under normal growing conditions with a harvest efficiency (HE) of 25 percent. These are conservative estimates that should be used only as guidelines in the initial stages of the conservation planning process. Often, the current plant composition does not entirely match any particular plant community described in this ecological site description. A field visit is required to document actual plant composition and production. More precise carrying capacity estimates, considering forage preference and accessibility (slope, distance to water, etc.), should be calculated using this information, particularly when grazers other than cattle are involved. Under more intensive grazing management, improved harvest efficiencies (up to 35 percent) can result in an increased carrying capacity, but recovery time for upland sites is much longer. If distribution problems occur, stocking rates should be reduced or facilitating conservation practices (i.e., cross-fencing, water development) implemented to maintain plant health and vigor.

Stocking rates are expressed in Animal Unit Months (AUMs) which is defined as the amount of forage consumed by a 1,000 pounds cow with a less than 4 month old calf at her side.

Plant Community - Production (lb./ac Low-RV-High) - AUMS/ac - ac/AUM

1.1.1 Big Sagebrush/Bunchgrass 400-550-700 0.08 13

1.1.2 Bunchgrass/Big Sagebrush 400-550-700 0.09 11

1.2.1 Big Sagebrush/Short-stature Grass 200-400-600 0.05 20

1.2.2 Short-stature Grass/Big Sagebrush 200-400-600 0.07 14

1.3.1 Rabbitbrush/Short-stature Grass 100-200-400 0.02 50

2.1 Reclaimed 400-550-700 0.12 8

2.2 Annuals 100-200-400 0.01 100

* Continuous, season-long grazing by cattle under average growing conditions.

Calculation for stocking rates are as follows: Using Representative (RV) values for production, take forage palatable to grazing cattle and multiply by 0.25 Harvest Efficiency (HE) and divide by 912.5 pounds per AUM air-dry weight (ADW) to arrive at the initial suggested stocking rate in AUMs per acre.

Grazing by domestic livestock is one of the major income-producing industries in the area. Rangeland in this area may provide year-long forage for cattle, sheep, or horses. During the dormant period, the forage for livestock must be supplemented with protein because the quality does not meet minimum livestock requirements.

Distance to water, shrub density, and slope can affect grazing capacity within a management unit. Accessibility adjustments should be made for the planning area as necessary. For example, 30 percent of a management unit may have 25 percent slopes and distances of greater than one mile from water, resulting in a 50 percent reduction in grazing access; therefore, the adjustment is calculated for 30 percent of the unit (i.e. 50 percent reduction on 30 percent of the management unit). Fencing, slope length, management, access, terrain, kind and class of livestock, and breeds are all factors that can increase or decrease the percent of grazing access within a management unit. Adjustments should be made that incorporate these factors when calculating the carrying capacity of a management unit.

Wildlife:

Land Use 1 - Range

Reference State:

1.1.1 Big Sagebrush/Bunchgrass: This community phase provides winter, transitional and summer habitat for Sage Grouse, mule deer, pronghorn, and elk. Although this community makes up a small portion on the overall landscape, the site occurs within areas highly used by big game species providing a diverse suite of herbaceous and shrub species important for micro-nutrient requirements for ungulates throughout the year. These areas also provide nesting habitat for sagebrush obligates, such as Sage Thrashers and Brewer's Sparrow, where sagebrush canopy and residual bunchgrasses hide nests and young from predators.

1.1.2 Bunchgrass/Big Sagebrush: This community phase provides foraging opportunities for ungulates during winter, transitional and summer seasonal ranges, however, suitable cover due to lower canopy of sagebrush is lacking. Year-round habitat is provided for Sage Grouse and many other sagebrush obligate species including both generalists and specialists. This community can be used as migration and stopover habitat by big game, but is generally a small component of the landscape. Spring green-up of grass is an important nutritional component of this community for migrating big game.

Grazing Resistance State:

1.2.1 Big Sagebrush/Short-stature Grass: This community phase is variable in its value to wildlife and provides potential foraging habitat for ungulates and Sage Grouse when the sagebrush plants are in a healthy condition. The diminished understory limits value of the site for birds and small mammals due to the lack of cover in the interspaces of the sagebrush plants.

1.2.2 Short-stature Grass/Big Sagebrush: This community phase is variable in its value to wildlife. A dominance of short-stature grasses, such as Sandberg bluegrass, provides foraging opportunities during spring green-up and is an important nutritional component of this community for migrating ungulates. A lack of big sagebrush limits foraging opportunities and protective cover for a suite of wildlife species including birds, small mammals, and big game.

Disturbed State:

1.3.1 Rabbitbrush/Short-stature Grass: These communities provide limited forage for pronghorn and mule deer due to low production and lack of sagebrush. They may be used as a foraging site by Sage Grouse and sagebrush generalists if proximal to woody cover, or seasonally used by cottontail or jack rabbits. The overall dominance of rabbitbrush is generally not ideal to support a wide variety of wildlife.

Land Use 2 – Mineral Extraction

2.1 Reclaimed: This community phase is highly variable in its value to wildlife. Reclamation success, size and configuration of the reclaimed area, the species planted, and the time it takes for plants to establish will determine the value of the site for wildlife. A fully reclaimed site containing a diversity of herbaceous and woody native plants can eventually provide the same wildlife habitat benefits as the reference state. In most cases, grasses and forbs establish early in the reclamation process, whereas shrubs take significantly longer to establish. Wildlife species dependent on herbaceous plant communities for forage (elk, prairie dogs, and fox) will benefit from reclamation sooner than those species dependent on a mixed shrub/grass community. Small mammals, such as mice (*Peromyscus* spp.) and birds can be found foraging in these areas shortly after reclamation practices.

2.2 Annuals/Bareground: This state is highly variable in its value to wildlife. Lack of perennial forbs, grasses, and shrub cover severely reduce the quality of forage for wildlife including ungulates such as mule deer and pronghorn. The area does provide limited foraging opportunities for small mammals and birds, but lacks any structure for escape cover.

Hydrological functions

Water is the principal factor limiting forage production on this site. This site is dominated by soils in hydrologic group A and B. Infiltration ranges from moderately rapid to rapid. Runoff potential for this site varies from moderate to high depending on soil hydrologic group and ground cover. In many cases, areas with greater than 75 percent ground cover have the greatest potential for high infiltration and lower runoff. Areas where ground cover is less than 50 percent have the greatest potential to have reduced infiltration and higher runoff (refer to Part 630, NRCS National Engineering Handbook for detailed hydrology information).

Rills may occur on steeper slopes, but are small and widely spaced. Water flow patterns may be present but should be barely distinguishable. Pedestals are only slightly present in association with bunchgrasses. Litter typically falls in place, and signs of movement are not common. Chemical and physical crusts are rare to non-existent.

Cryptogamic crusts are present, but only cover one to two percent of the soil surface.

Recreational uses

This site provides hunting opportunities for upland game species. The wide variety of plants that bloom in the spring have an aesthetic value that appeals to recreationists.

Inventory data references

Information presented here has been derived from historic and recent clipping data and other inventory data. Field observations from range trained personnel were also used.

Inventory Data Resources include:

3 National Resource Inventory (NRI) points (2004-2016)

4 Bureau of Land Management Assessment, Inventory, and Monitoring (BLM-AIM) points (2004-2018) - 2 points are duplicate of NRI

4 Tier I NRCS Ecological Site Inventory (NRCS-ESI) points (2004-2005)

1 BLM-ESI point (2018)

17 Soil Survey-ESI points (2018-2019)

References

. 2021 (Date accessed). USDA PLANTS Database. <http://plants.usda.gov>.

. 2021 (Date accessed). USNVC [United States National Vegetation Classification]. 2019. United States National Vegetation Classification Database, V2.03. Federal Geographic Data Committee, Vegetation Subcommittee, Washington DC.. USNVC: <http://usnvc.org/>.

. March 2021. National Resources Inventory Grazing Land On-Site Data Collection Handbook of Instructions . Natural Resources Conservation Service.

Aikens, E.O., M.J. Kauffman, J.A. Merkle, Dwinnell, G.A. Fralick, and K.L. Monteith. 2017. The greenscape shapes surfing of resource waves in a large migratory herbivor.. *Ecology Letters* 20:741–750.

Bestelmeyer, B., J.R. Brown, K.M. Havstad, B. Alexander, G. Chavez, and J.E. Herrick. 2003. Development and Use of State and Transition Models for Rangelands. *Jornal of Range Management* 56:114–126.

Bestelmeyer, B. and J.R. Brown. 2005. State-and-Transition Models 101: a Fresh Look at Vegetation Change.

Bestelmeyer, B., J.R. Brown, J.E. Herrick, D.A. Trujillo, and K.M. Havstad. 2004. Land Management in the American Southwest: a state-and-transition approach to ecosystem complexity. *Environmental Management* 34:38–51.

Bestelmeyer, B. and J. Brown. 2005. State-and-Transition Models 101: A Fresh look at vegetation change.

Bestelmeyer, B.T., K. Moseley, P.L. Shaver, H. Sanchez, D.D. Briske, and M.E. Fernandez-Gimenez. 2010. Practical guidance for developing state-and-transition models. *Rangelands* 32:23–30.

Bowker, K.A. 2000. Jonah Field: A Shallow Sweetspot in the Basin-Centered Gas Accumulation of the Northern Green River Basin, Wyoming..

Briske, D.D., B.T. Bestelmeyer, T.K. Stringham, and P.L. Shaver. 2008. Recommendations for Development of Resilience-Based State-and-Transition Models. *Rangeland Ecology & Management* 61:359–367.

Chambers, J.C., J.L. Beck, T.J. Christiansen, K.J. Clause, J.B. Dinkins, K.E. Doherty, K.A. Griffin, D.W. Havlina, K.F. Henke, L.L. Kurth, J.D. Maestas, M. Manning, K.E. Mayer, B.A. Meador, C. McCarthy, M.A. Perea, and D.A. Pyke. 2016. Using resilience and resistance concepts to manage threats to sagebrush ecosystems, Gunnison sage-grouse, and Greater sage-grouse in their eastern range: A strategic multi-scale approach.. Gen. Tech. Rep. RMRS-GTR-356.. U.S. Department of Agriculture, Forest Service, Rocky Mountain Research Station, Fort Collins, CO. 1–143.

Clause, K. and J. Randall. 2014. Wyoming Sagebrush Die-Off Report. Unpublished.

Innes, R.J. 2019. Fire regimes of Wyoming big sagebrush and basin big sagebrush communities.. Fire Effects Information System. U.S. Department of Agriculture, Forest Service, Rocky Mountain Research Station, Missoula Fire Sciences Laboratory.

Martin, J.L. 1996. Geohydrology of Tertiary Rocks in the Green River Structural Basin in Wyoming, Utah, and Colorado.. Water-Resources Investigations Report 92-4164. US Geological Survey.

Miller, J.F., R.H. Frederick, and R.J. Tracey. 1973. "Precipitation-Frequency Atlas of the United States" NOAA Atlas 2, Volume 2 (Wyoming). National Weather Service, Silver Spring, Maryland.

Schoeneberger, P.J. and D.A. Wysocki. 2017. Geomorphic Description System, Version 5.0..

Stringham, T.K., W.C. Kreuger, and P.L. Shaver. 2003. State and Transition Modeling: an ecological process approach. *Journal of Range Management* 56:106–113.

Stringham, T.K. and W.C. Krueger. 2001. States, Transitions, and Thresholds: Further refinement fro rangeland applications.

U. S. Environmental Protection Agency. 2010. Level III and IV ecoregions of the continental United States. U.S. EPA, National Health and Environmental Effects Research Laboratory, Corvallis, Oregon, U.S..

Winward, A. 2007. Boulder, Squaretop Area Field Notes. Field Notes. Unpublished.

Other references

Site concept, plant community data, and interpretations are based on ecological site descriptions (ESDs) from MLRA 34A-Foothills and Basins West (10-14W).

This ESD replaces R034AY266WY Shallow Sandy MLRA 34A-Foothills and Basins West (SwSy 10-14W), but only within geographic extent of the Pinedale Plateau LRU.

Further data collection and ecological site refinement are ongoing until the ESD has reached "Approved" status.

Contributors

Bryan Christensen

Karen J. Clause

Approval

Acknowledgments

Sublette County Conservation District
Wyoming Game and Fish Department

Rangeland health reference sheet

Interpreting Indicators of Rangeland Health is a qualitative assessment protocol used to determine ecosystem condition based on benchmark characteristics described in the Reference Sheet. A suite of 17 (or more) indicators are typically considered in an assessment. The ecological site(s) representative of an assessment location must be known prior to applying the protocol and must be verified based on soils and climate. Current plant community cannot be used to identify the ecological site.

Author(s)/participant(s)	
Contact for lead author	
Date	05/01/2024
Approved by	Kirt Walstad
Approval date	
Composition (Indicators 10 and 12) based on	Annual Production

Indicators

1. **Number and extent of rills:**

2. **Presence of water flow patterns:**

3. **Number and height of erosional pedestals or terracettes:**

4. **Bare ground from Ecological Site Description or other studies (rock, litter, lichen, moss, plant canopy are not bare ground):**

5. **Number of gullies and erosion associated with gullies:**

6. **Extent of wind scoured, blowouts and/or depositional areas:**

7. **Amount of litter movement (describe size and distance expected to travel):**

8. **Soil surface (top few mm) resistance to erosion (stability values are averages - most sites will show a range of values):**

-
9. **Soil surface structure and SOM content (include type of structure and A-horizon color and thickness):**
-
10. **Effect of community phase composition (relative proportion of different functional groups) and spatial distribution on infiltration and runoff:**
-
11. **Presence and thickness of compaction layer (usually none; describe soil profile features which may be mistaken for compaction on this site):**
-
12. **Functional/Structural Groups (list in order of descending dominance by above-ground annual-production or live foliar cover using symbols: >>, >, = to indicate much greater than, greater than, and equal to):**
- Dominant:
- Sub-dominant:
- Other:
- Additional:
-
13. **Amount of plant mortality and decadence (include which functional groups are expected to show mortality or decadence):**
-
14. **Average percent litter cover (%) and depth (in):**
-
15. **Expected annual annual-production (this is TOTAL above-ground annual-production, not just forage annual-production):**
-
16. **Potential invasive (including noxious) species (native and non-native). List species which BOTH characterize degraded states and have the potential to become a dominant or co-dominant species on the ecological site if their future establishment and growth is not actively controlled by management interventions. Species that become dominant for only one to several years (e.g., short-term response to drought or wildfire) are not invasive plants. Note that unlike other indicators, we are describing what is NOT expected in the reference state for the ecological site:**
-
17. **Perennial plant reproductive capability:**
-