

# Ecological site EX043B18H036

## Droughty 15-19 inches precipitation zone Cryic Beaverhead Mountains

Last updated: 3/04/2024  
Accessed: 04/19/2024

---

### General information

**Provisional.** A provisional ecological site description has undergone quality control and quality assurance review. It contains a working state and transition model and enough information to identify the ecological site.

### MLRA notes

Major Land Resource Area (MLRA): 043B—Central Rocky Mountains

Major Land Resource Area (MLRA) 43B, Central Rocky Mountains, is an expansive area covering some 76,000 square miles. This area is nearly equally divided amongst the states Idaho (32 percent), Montana (38 percent), and Wyoming (30 percent) with a very small portion in extreme Northeast Utah. The land area of this MLRA is largely federally owned and administered by the US Forest Service.

MLRA 43B is defined by its rugged mountains and contains both Montana's and Wyoming's tallest peaks. These mountains follow the Continental Divide and are the source for several major watersheds including the Columbia River, Snake River, Missouri River, and Yellowstone River. This water is primarily used in neighboring MLRAs as irrigation; however, it also supplies urban populations with domestic water and a growing recreational industry via fishing and boating.

The Central Rocky Mountains is used primarily for its forest/timber resources, and is used for grazing livestock. This area also provides for a vast recreational opportunities. The forests are dominated by coniferous trees such as ponderosa pine, Douglas fir, lodgepole pine, subalpine fir, and spruce. High elevation alpine forests may also include whitebark pine. The grazing lands of MLRA 43B are as variable and numerous as their forested counterparts with dominant grass and grass-like species including bluebunch wheatgrass, pinegrass, elk sedge, rough fescue, Idaho fescue, spike fescue, multiple bluegrass species, as well as numerous needlegrasses.

### LRU notes

Land Resource Unit (LRU) 18, of MLRA 43B, is also known as the Beaverhead Mountains LRU. It occupies approximately 4.2 million acres and generally resides on the border of Idaho and Montana. This LRU includes the Pioneer, Ruby, Beaverhead, Centennial, Gravelly, Snowcrest, Tobacco Root, Blacktail, and Tendoy Mountains. This LRU shares a boundary with MLRA 44B (Central Rocky Mountain Valleys), MLRA 12 (Lost River Valleys and Mountains), and MLRA 13 (Eastern Idaho Plateaus).

Like the majority of the LRUs within MLRA 43B, the geology of LRU 18 is best described as mixed, but are dominated by the Belt Supergroup. This geological supergroup is primarily sedimentary rocks with intrusive volcanics. The geological mix of this LRU includes Ravalli group; Piegan group; Missoula group; Tertiary volcanics; Mississippian group; Pennsylvanian group; Pre-belt gneiss, schist, and related rocks; Triassic and Permian; Montana group; Boulder batholith; Devonian Cambrian Undifferentiated; and alluvium. The geological formations of this LRU can contain significant amounts of mineral deposits such as gold, copper, silver, lead, platinum, palladium, and other precious metals.

LRU 18 is dominated by deep and very deep soils that formed on a variety of parent materials with shallow and mod-deep soils on ridges and near areas of rock outcrop. Moderate to very steep slopes dominate, however broad, gently to moderately sloping areas also occur. Rock outcrop, rubble land, and surface rock fragments are common throughout these mountains, with many soils expressing rock fragments within the profile. Soil pH is highly variable

particularly due to the mixed nature of the geology and varied precipitation amounts. Soils with lower precipitation, in this LRU, commonly have higher pH than those of higher precipitation. Most soils of this area fall into four soil orders: Entisols, Inceptisols, Mollisols, and Alfisols; soil profiles display very limited to highly developed horizonation and structure.

Climatic Subset D:

- Frost Free Days (FFD) = 50 to 70 days
- Relative Effective Annual Precipitation (REAP) = 15 to 19 inches
- Moisture Regime: Typic, Ustic or Xeric (limited)
- Soil Temperature Regime: Cryic, warm

Climate Subset D typically resides at the lower elevations of MLRA 43B, LRU 18 in transition area between MLRAs. Significant overlap between these area's plant communities may exist as a result.

## **Classification relationships**

EPA Ecoregions of Montana, Second Edition:

Level I: Northwestern Forested Mountains

Level II: Western Cordillera

Level III: Middle Rockies

Level IV: Forested Beaverhead Mountains

Western Beaverhead Mountains

Barren Mountains

Eastern Gravelly Mountains

Pioneer-Anaconda Ranges

Eastern Pioneer Sedimentary Mountains

Tobacco Root Mountains

Dry Gneissic-Shistose-Volcanic Hills

National Hierarchical Framework of Ecological Units (Forest Service):

Domain: Dry

Division: M330 – Temperate Steppe Division – Mountain Provinces

Province: M332 – Middle Rocky Mountain Steppe – Coniferous Forest – Alpine Meadow

Section: M332E – Beaverhead Mountains Section

National Vegetation Classification System (NVC):

2 Shrub & Herb Vegetation

2.B Temperate & Boreal Grassland & Shrubland

2.B.2 Temperate Grassland & Shrubland

2.B.2.Na Western North American Grassland & Shrubland

M048 Central Rocky Mountain Montane-Foothill Grassland & Shrubland

G267 Central Rocky Mountain Montane Grassland Group

G273 Central Rocky Mountain Lower Montane, Foothill & Valley Grassland Group

## **Ecological site concept**

- Site does not receive any additional water
- Soils are
  - o Not saline or saline-sodic
  - o Moderately deep, deep, or very deep
  - o Typically less than 5 percent stone and boulder cover with a maximum of 15 percent
  - o Skeletal (greater than 35 percent rock fragments by volume) at 10-20 inch control section
  - o Not strongly or violently effervescent within surface mineral 4 inch; normally calcium carbonates increase with depth
  - o Clay content is less than 32 percent in surface mineral 4 inches.
  - o Soil does not have an argillic horizon with greater than 35 percent clay.
- Soil surface texture ranges from sandy loam to clay loam in surface mineral 4 inches
- Slope is less than 15 percent
- Parent material is primarily colluvium and slope alluvium.

## Associated sites

EX043B18H038	<p><b>Droughty Steep 15-19 inches precipitation zone Cryic Beaverhead Mountains</b></p> <p>EX043B18D038 (Droughty Steep): Droughty Steep and Droughty sites are often neighboring sites. The Droughty Steep site is located on similar landscape that is 15 percent slope or greater. Plant communities are similar in species present and share similar State-and-Transition Models. The Droughty Steep site is highly affected by both slope and aspect which often results in production variations.</p>
EX043B18H032	<p><b>Loamy 15-19" PZ Cryic Beaverhead Mountains</b></p> <p>EX043B18D032 (Loamy): The Loamy Ecological site of this LRU expresses a similar plant community and resides on similar landscapes. Often this site expresses increased biomass production over the Droughty Site and will also express an increased amount of basin wildrye, green needlegrass, and Columbia needlegrass. Some states of the Loamy and Droughty sites may be nearly indistinguishable without a soils pit.</p>

## Similar sites

EX043B18H032	<p><b>Loamy 15-19" PZ Cryic Beaverhead Mountains</b></p> <p>EX043B18D032 (Loamy): The Loamy Ecological site of this LRU expresses a similar plant community and resides on similar landscapes. The Loamy site often expresses increased biomass production over the Droughty site and will also express an increased amount basin wildrye, green needlegrass, and Columbia needlegrass. Some states of the Loamy and Droughty sites may be nearly indistinguishable without a soils pit.</p>
EX043B18H038	<p><b>Droughty Steep 15-19 inches precipitation zone Cryic Beaverhead Mountains</b></p> <p>EX043B18D038 (Droughty Steep): The Droughty Steep and Droughty sites are often neighboring sites. The Droughty Steep site is located on similar landscape that is 15 percent slope or greater. Plant communities are similar in species present as well as share similar State-and-Transition Models. The Droughty Steep site is highly affected by both slope and aspect which often results in production variations.</p>

**Table 1. Dominant plant species**

Tree	Not specified
Shrub	(1) <i>Artemisia tridentata</i> (2) <i>Tetradymia canescens</i>
Herbaceous	(1) <i>Pseudoroegneria spicata</i> (2) <i>Festuca idahoensis</i>

## Legacy ID

R043BZ336MT

## Physiographic features

This site exists on the middle third to top of gently sloping mountain slopes, hillslopes, fan remnants, and piedmont slope. Site slopes vary from nearly level to less than 15 percent however the central concept of the site exists between 4 and 10 percent slope.



Figure 1. MLRA 43B LRU 18

Table 2. Representative physiographic features

Geomorphic position, mountains	(1) Mountaintop (2) Upper third of mountainflank
Hillslope profile	(1) Shoulder (2) Backslope
Landforms	(1) Mountains > Mountain slope (2) Foothills > Hillslope (3) Mountains > Fan remnant (4) Piedmont slope
Elevation	5,500–7,500 ft
Slope	0–15%
Water table depth	60 in
Aspect	W, NW, N, NE, E, SE, S, SW

### Climatic features

This ecological site exists in the Climate Subset D which is described as receiving 15 to 19 inches of Relative Effective Annual Precipitation (REAP) and having 50 to 70 Frost Free Days (FFD). The average Relative Effective Annual Precipitation (REAP) for this Subset is 17 inches of precipitation with 65 FFD. This subset within the Beaverhead Mountains LRU has very limited climate station data due to the remote locations away from populated areas and Snowtel sites.

This climate subset tends to reside in the middle 1/3 to top of a mountain and hill slopes in a transitional area between MLRAs

Table 3. Representative climatic features

Frost-free period (characteristic range)	63-67 days
Freeze-free period (characteristic range)	99-109 days
Precipitation total (characteristic range)	16-18 in
Frost-free period (actual range)	61-69 days
Freeze-free period (actual range)	96-112 days
Precipitation total (actual range)	15-18 in
Frost-free period (average)	65 days
Freeze-free period (average)	104 days
Precipitation total (average)	17 in

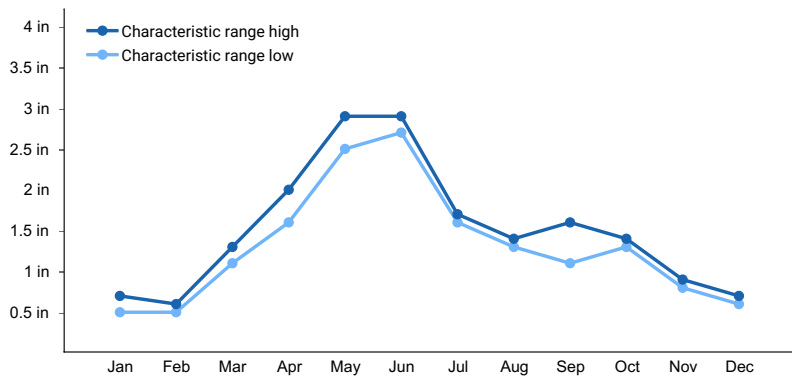

**Figure 2. Monthly precipitation range**

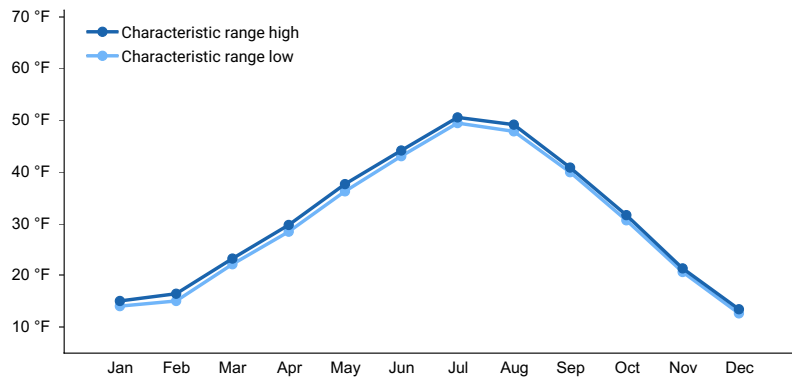

**Figure 3. Monthly minimum temperature range**

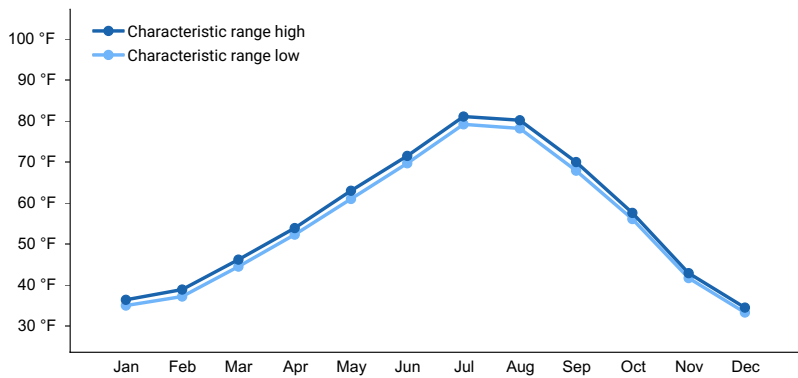

**Figure 4. Monthly maximum temperature range**

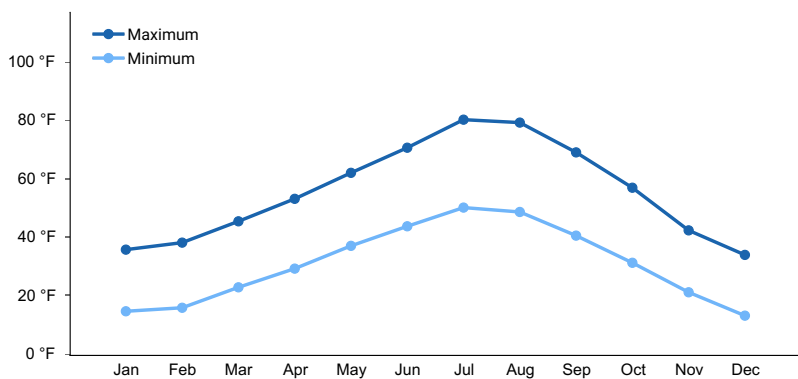

**Figure 5. Monthly average minimum and maximum temperature**

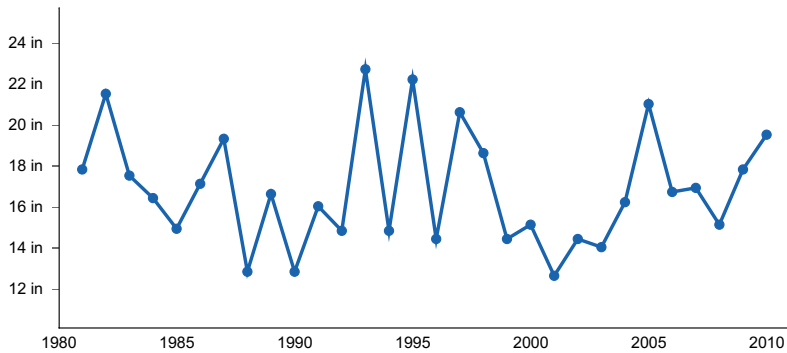

**Figure 6. Annual precipitation pattern**

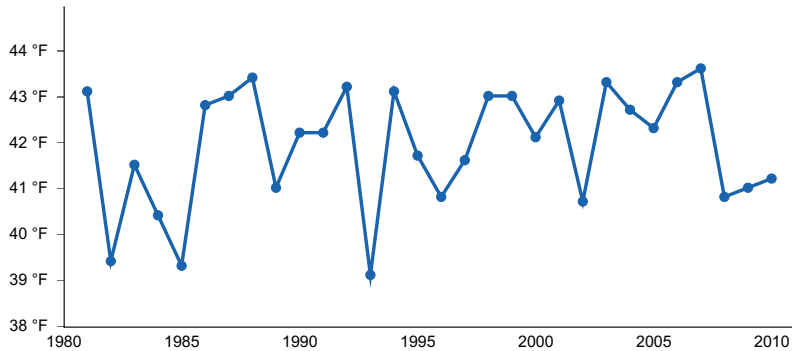

**Figure 7. Annual average temperature pattern**

### Climate stations used

- (1) PONY [USC00246655], Cardwell, MT
- (2) VIRGINIA CITY [USC00248597], Virginia City, MT

### Influencing water features

The Droughty ecological site is characterized by having greater than 35 percent rock fragments in the top 10 to 20 inches of the soil profile. Often the rock fragments increase with depth. These rock fragments reduce the overall soil water holding capacity. This is a water limited site with precipitation often infiltrating faster into the soil than running off. The exception is during high precipitation events associated with convective summer storms.

### Wetland description

Site is not associated with wetlands.

### Soil features

Soils are moderately deep to very deep, moderately slow to moderately rapid permeability, and well drained. The soils formed from colluvium and slope alluvium. The soil consists of loamy-skeletal material (greater than 35 percent rock fragments by volume in the top 10 to 20 inches of the profile). The skeletal material decreases the water-holding capacity, making the site easily susceptible to drought conditions. Typically soil surface textures consist of loam, gravelly loam, sandy loam, and cobbly loam, but may include clay loams. Common soil series are MacIver, Farlin, and Libeg. Soil pH at the surface will be variable across the LRU and range from 6.2 to 7.8. Due to the mixed geology, pH may increase with depth. The Droughty ecological site will not be violently effervescent in the top 4 inches of soil. These soils may exist across multiple ecological sites due to natural variations in slope, texture, rock fragments, and pH. An onsite soil pit and most current Ecological Site Key are required to classify an ecological site.



Figure 8. Droughty typical soil profile.

Table 4. Representative soil features

Parent material	(1) Colluvium–igneous, metamorphic and sedimentary rock (2) Slope alluvium–igneous, metamorphic and sedimentary rock
Surface texture	(1) Cobbly, gravelly loam (2) Sandy loam
Family particle size	(1) Loamy-skeletal
Drainage class	Well drained
Permeability class	Moderately slow to rapid
Depth to restrictive layer	20–60 in
Surface fragment cover <=3"	0–22%
Surface fragment cover >3"	0–10%
Available water capacity (0-40in)	1.5–6.2 in
Soil reaction (1:1 water) (0-4in)	6.2–7.8

## Ecological dynamics

The Droughty (Dr) ecological site is characterized by the production and composition of the Reference Plant Community, which is defined by soils, precipitation, and the temperature regime influencing the site. In the Beaverhead Mountains LRU of MLRA 43B, Subset D is found where a Typic, Ustic soil moisture regime and Cryic temperature regime exist. This equates to a yearly representative value of 15 to 19 inches of relative effective annual precipitation and between 50 and 70 consecutive frost-free days. The Droughty ecological site is characterized by having skeletal soils greater than 20 inches deep and by not being strongly or violently effervescent in the top 4 inches of the soil surface. This is an upland site that is heavily influenced by aspect, resulting in variations in plant communities. The Droughty Ecological Site extent in the Beaverhead Mountains LRU is limited and often resides on the edge of this MLRA.

The majority of precipitation comes in April, May and June. Primary growth typically occurs between May and July with dominant plants that have adapted to these conditions. The warmer, drier section of this LRU primary growth typically occurs between April and June. A period of fall green-up can occur amongst this cool season dominated plant community if adequate precipitation is present.

The reference plant community is dominated by bluebunch wheatgrass (*Pseudoroegneria spicata*), and Idaho fescue (*Festuca idahoensis*). Subdominant species include Wyoming and mountain big sagebrush with thickspike wheatgrass (*Elymus lanceolatus*), Columbia needlegrass (*Achnatherum nelsonii*) and green needlegrass (*Nassella viridula*). The Soil and Vegetation Inventory of Near-pristine Sites of Montana suggests that the reference

community is dominated primarily of bunchgrasses with approximately 20 percent of the community being shrubs (Ross et al. 1973). Other historical accounts also suggest that sagebrush and other shrubs were less extensive in the historic plant community for this area (Hayden 1873).

As stated above both Wyoming big sagebrush (*Artemisia tridentata* ssp *wyomingensis*) and mountain big sagebrush (*Artemisia tridentata* spp *vasayena*) exist on this site; sometimes in a homogeneous nature. This overlap of subspecies may express a third genotype of big sagebrush known as Bonneville big sagebrush (*Artemisia tridentata* ssp *xbonnevillensis*). This hybridization of Wyoming and mountain big sagebrush has not been officially observed in this LRU; however, it does occur on similar landscapes in Western Wyoming, Eastern Idaho, and Northeast Utah with similar climates.

Fire has historically been a powerful driver of this community. Some estimates of fire return intervals are as long as 200 years in some sagebrush communities. A local study (Arno and Gruell 1982) suggests a fire return interval of 20 to 40 years. These frequent fires limited conifer expansion on this site, maintained potential small aspen groves, and limited dense sagebrush communities. Communities that have changed over time to be dominated by three-tip sagebrush (*Artemisia tripartita*) may be a result of frequent fire that removed or suppressed big sagebrush.

The Droughty ecological site occurs across a relatively large landscape with slight variations occurring in the plant community due to elevation, frost-free days, aspect, and relative effective annual precipitation. These slight variations tend to manipulate the amounts of individual species while the core species are rarely changed.

This ecological site is largely intact and is primarily used for livestock grazing. Historical records indicate, prior to the introduction of livestock (cattle and sheep) during the late 1800's, elk and bison grazed this ecological site (Lesica and Cooper 1997). Due to the nomadic nature and herd structure of bison, areas that were grazed received periodic high intensity short duration grazing pressure. Meriwether Lewis documented that he was met by 60 Shoshone warriors on horseback in August 1805 and the Corps of Discovery was later supplied with horses by the same band of Shoshone (Moulton and Dunlay 1988). This suggests that the areas near the modern day Montana towns of Twin Bridges, Bannack, Dillon, Grant, and Dell were grazed by an untold number of horses for years prior to the large introduction of cattle and sheep.

Livestock grazing has occurred on most of this ecological site for more than 150 years. The gold boom in the 1860s brought the first herds of livestock overland from Texas, and homesteaders began settling the area. Since the 1930's cattle production has dominated the livestock industry in the region (Wyckoff and Hansen 2001).

Dense clubmoss (*Selaginella densa*), in general, is a very minor component of the Reference Plant Community of the Droughty ecological site. The conditions that created large cover classes of clubmoss on this site point to a history of continuous (yearlong) or moderate spring grazing use (Sturm 1954). While dense clubmoss provides soil stability, anecdotal accounts by some land managers suggest that it competes for the limited water resources in the upper soil profile which, in turn, restricts plant available water. However a study from Canada (Colberg and Romo 2003), in a similar climate and on similar soils, indicates that the correlation between reduced plant available water and clubmoss cover is negligible. The correlation between reduced plant production may simply be competition for space though quantitative evidence is unavailable. Dense patches of clubmoss also inhibit seed contact with soil reducing seedling recruitment.

Some of the major invasive species that can occur on this site include (but not limited to) spotted knapweed (*Centaurea stoebe*), leafy spurge (*Euphorbia esula*), cheatgrass (*Bromus tectorum*), field brome (*Bromus arevensis*), yellow toadflax (*Linaria vulgaris*), Kentucky bluegrass (*Poa pratensis*), and dandelion (*Taraxicum* spp). Invasive weeds are beginning to have a high impact on this ecological site due to primarily human impacts, mismanaged grazing, and urban development. Cheatgrass and spotted knapweed pose the largest threat to this ecological site.

#### Plant Communities and Transitional Pathways

A State and Transition Model for the Droughty ecological site is depicted below. Thorough descriptions of each state, transition, plant community, and pathway follow the model. This model is based on available experimental research, field data, field observations, and interpretations by experts. It is likely to change as knowledge increases.

The plant communities within the same ecological site will differ across the MLRA due to the naturally occurring



variability in weather, soils, and aspect. The biological processes on this site are complex; therefore, representative values are presented in a land management context. The species lists are representative and are not botanical descriptions of all species occurring, or potentially occurring, on this site. They are intended to cover the core species and known range of conditions and responses.

Both percent species composition by weight and percent canopy cover are referenced in this document. Most observers find it easier to visualize or estimate percent canopy for woody species (trees and shrubs). Canopy cover drives the transitions between communities and states because of the influence of shade, interception of rainfall and competition for available water. Species composition by dry weight remains an important descriptor of the herbaceous community and of the community as a whole. Woody species are included in species composition for the site. Calculating similarity index requires use of species composition by dry weight.

This State and Transition Model (STM) includes only rangeland communities and states. The converted communities are described in the Ecological Dynamics of the Site section above.

Although there is considerable qualitative experience supporting the pathways and transitions within the State and Transition Model (STM), no quantitative information exists that specifically identifies threshold parameters between grassland types and invaded types in this ecological site. For information on STMs, see the following citations: Bestelmeyer et al. 2003; Bestelmeyer and Brown 2005a; Bestelmeyer and Brown 2005b; Briske et al. 2008; Bestelmeyer et al. 2010; Bestelmeyer et al. 2016

## State and transition model

### Ecosystem states

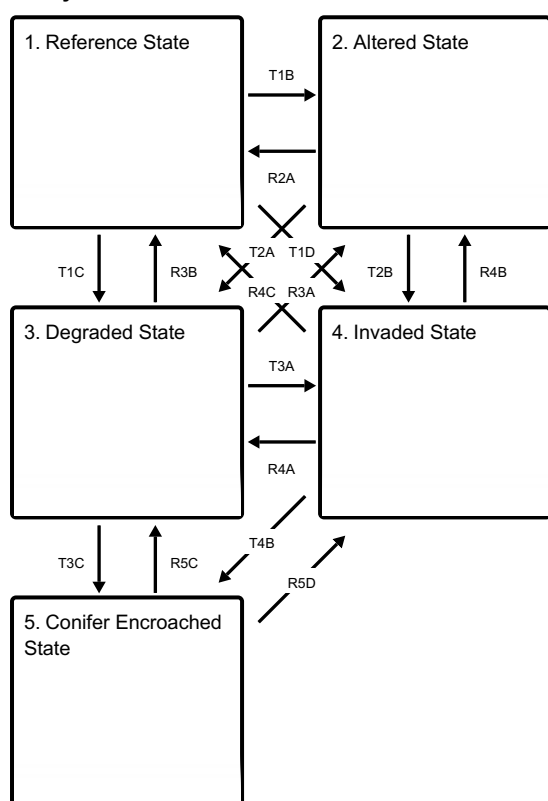

### States 1, 5 and 2 (additional transitions)

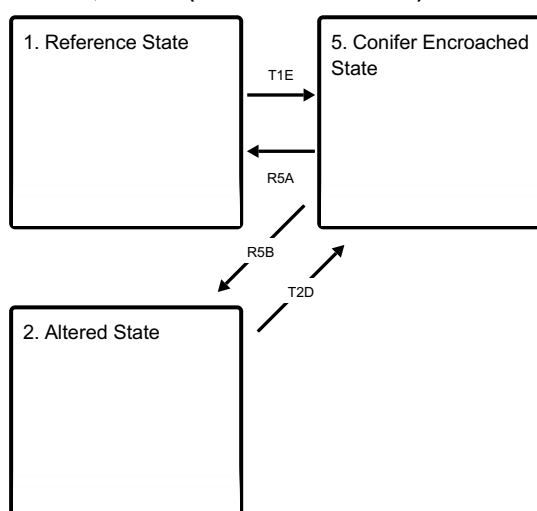

**T1B** - The trigger for this transition is improper grazing management and long-term drought leading to a decrease in bluebunch wheatgrass composition and reduction in total plant canopy cover.

**T1C** - The driver for this transition is improper grazing management, intense or repeated fires, or heavy human disturbance.

**T1D** - Long-term stress conditions for native species (e.g., overgrazing, drought, and fire) accelerate this transition.

**T1E** - Conifer tree/shrub count exceeds two stems per acre. The trigger of crossing a threshold is the presence of seeds and/or other viable material of these tree species.

**R2A** - The drivers for this restoration pathway are reclamation efforts along with proper grazing management.

**T2A** - As improper grazing continues, vigor of bunchgrasses will decrease, and the shorter grasses and shrubs will increase towards the Degraded State (3).

**T2B** - The driver for this transition is more than 10 percent dry weight of invasive species.

- T2D** - Conifer tree/shrub count exceeds two stems per acre. The trigger of crossing a threshold is the presence of seeds and other viable material of these tree species.
- R3A** - Restoration methods such as reseeding may be necessary
- T3A** - The driver for this transition is presence of critical population levels of invasive species.
- T3C** - Conifer tree/shrub count exceeds 2 stems per acre. The trigger of crossing a threshold is the presence of seeds and/or other viable material of these tree species.
- R4C** - The drivers for the restoration pathway are removal of invasive species, restoration of native bunchgrass species, persistent management of invasive species, and proper grazing management.
- R4B** - The driver for the reclamation pathway is weed management with possible reseeding.
- R4A** - The driver for the reclamation pathway is weed management without reseeding.
- T4B** - Canopy cover of conifer tree/shrub cover exceeds two stems per acre. The threshold change is triggered by the presence of seeds and other viable material of invasive species.
- R5A** - Depending on the level of conifer canopy cover and its impact on rangeland health, restoration efforts may simply focus on removal of coniferous trees and shrubs to restore the Conifer Encroached State (5) to the Reference State (1).
- R5B** - If utilizing the phases established by Miller et al, management and restoration methods will vary.
- R5C** - The Conifer Encroached State (5) Phases II and III will likely resemble the Degraded State (3) on this site due to reduced mid-statured bunchgrasses. If utilizing the phases established by Miller et al management and restoration methods will vary.
- R5D** - If utilizing the phases established by Miller et al management and restoration methods will vary.

**State 1 submodel, plant communities**

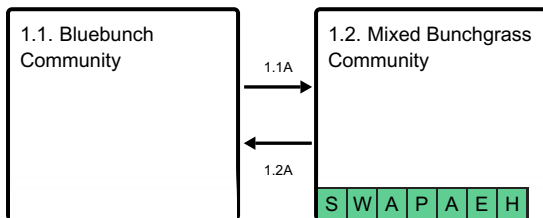

- 1.1A** - Mid-statured bunchgrasses lose vigor with improper grazing, extended drought, or unusually hot fire.
- 1.2A** - The Mixed Bunchgrass Community (1.2) will return to the Bluebunch Community (1.1) with proper grazing management and appropriate grazing intensity.

**State 2 submodel, plant communities**

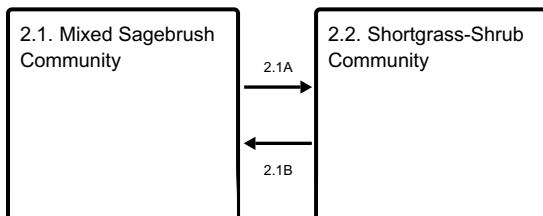

- 2.1A** - The driver for community shift 2.1A is continued overgrazing.
- 2.1B** - If grazing management is implemented, Idaho fescue may regain its vigor and move towards the Mixed Sagebrush Community (2.1).

**State 3 submodel, plant communities**

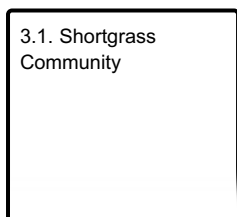

#### State 4 submodel, plant communities

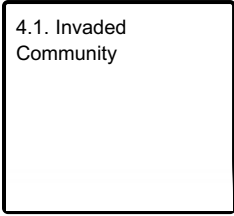

#### State 5 submodel, plant communities

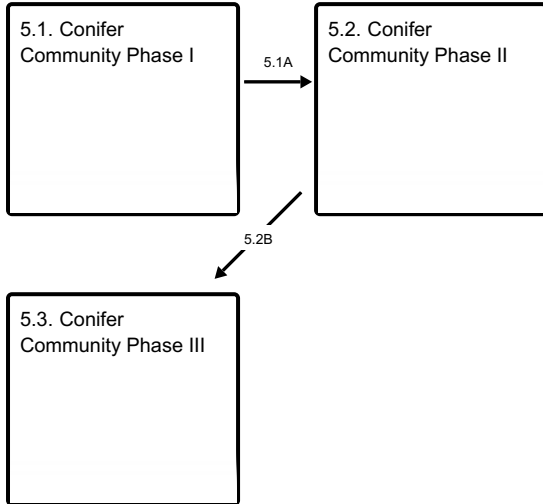

**5.1A** - The driver for this pathway is primarily lack of fire

**5.2B** - The driver for this pathway is primarily lack of fire.

### State 1 Reference State



**Figure 9. Early spring conditions of Reference State.**

The Reference State of the Droughty ecological site consists of 2 known potential plant communities, 1.1 Bluebunch Community and 1.2 Mixed Bunchgrass Community. These are described below but are generally characterized by a mid-statured, cool-season grass community with limited shrub production. Community 1.1 is dominated by bluebunch wheatgrass with subdominants of Idaho fescue, green needlegrass, Columbia needlegrass, and thickspike wheatgrass. This community is considered the Reference Plant Community while Community 1.2 is an At-Risk Plant Community for this state; co-dominated by bluebunch wheatgrass and Idaho fescue with big sagebrush as the dominant shrub.

### Community 1.1 Bluebunch Community

This community occurs in areas with low grazing use. Prior to the introduction of expansive livestock herds basin wildrye may have dominated this ecological site as suggested by a Forest Service Technical Report (Gruell 1983), however quantitative evidence is lacking as relict sites are very few and small in size. In the Bluebunch Community, bluebunch wheatgrass (*Pseudoroegneria spicata*), Idaho fescue (*Festuca idahoensis*), and Columbia needlegrass (*Acnatherum nelsonii*) are dominant. Basin wildrye (*Elymus cinereus*), green needlegrass (*Nasella viridula*), and Cusick's bluegrass (*Poa cusickii*) will be subordinate grasses. Shrub species such as common snowberry (*Symphoricarpos albus*), mountain big sagebrush (*Artemisia tridentata* ssp *vaseyana*), Wyoming big sagebrush (*Artemisia tridentata* ssp *wyomingensis*), and spineless horsebrush (*Tetradymia canescens*) remain a minor part of the community (Hayden 1873). In areas where the soil texture is coarser, spineless horsebrush (*Tetradymia canescens*) tends to be more common. Sandberg bluegrass (*Poa secunda*) and dryland sedges will also be present.

**Resilience management.** Bluebunch wheatgrass lacks resistance to grazing during the critical growing season and will decline in vigor and production if grazed in the critical growing season more than one year in three (Wilson et al. 1960). The critical growing period for bluebunch wheatgrass is late spring (June). This community is moderately resilient and will return to dynamic equilibrium following a relatively short period of stress (such as drought or short-term improper grazing), provided a return of favorable or normal growing conditions, and properly managed grazing. Improper grazing is defined as grazing utilization that exceeds moderate use (less than 50 percent grazing use) and/or multiple grazing events of a plant in the same growing season without rest. As discussed in the Ecological Dynamics section, natural fire regime restricted shrubs to relatively small portions of Community 1.1. Shrub species not listed above may also include, but not limited to, Bonneville big sagebrush (*Artemisia tridentata* ssp *xbonnevillensis*), shrubby cinquefoil (*Dasiphora fruticosa*), silver sagebrush (*Artemisia cana*), winterfat (*Krascheninnikovia lanata*), tarragon (*Artemisia drucunculus*), and fringed sagewort (*Artemisia frigida*).

### Dominant plant species

- mountain big sagebrush (*Artemisia tridentata* ssp. *vaseyana*), shrub
- common snowberry (*Symphoricarpos albus*), shrub
- Wyoming big sagebrush (*Artemisia tridentata* ssp. *wyomingensis*), shrub
- spineless horsebrush (*Tetradymia canescens*), shrub
- yellow rabbitbrush (*Chrysothamnus viscidiflorus*), shrub
- bluebunch wheatgrass (*Pseudoroegneria spicata*), grass
- Idaho fescue (*Festuca idahoensis*), grass
- basin wildrye (*Leymus cinereus*), grass
- western wheatgrass (*Pascopyrum smithii*), grass
- lupine (*Lupinus*), other herbaceous
- common yarrow (*Achillea millefolium*), other herbaceous
- beardtongue (*Penstemon*), other herbaceous
- western stoneseed (*Lithospermum ruderales*), other herbaceous

Table 5. Annual production by plant type

Plant Type	Low (Lb/Acre)	Representative Value (Lb/Acre)	High (Lb/Acre)
Grass/Grasslike	840	1090	1350
Forb	170	220	270
Shrub/Vine	110	140	170
Tree	0	10	50
<b>Total</b>	<b>1120</b>	<b>1460</b>	<b>1840</b>

Table 6. Ground cover

Tree foliar cover	0-1%
Shrub/vine/liana foliar cover	0-15%
Grass/grasslike foliar cover	35-50%
Forb foliar cover	5-15%

Non-vascular plants	0%
Biological crusts	0-3%
Litter	25-35%
Surface fragments >0.25" and <=3"	0-10%
Surface fragments >3"	0-5%
Bedrock	0%
Water	0%
Bare ground	0%

**Table 7. Soil surface cover**

Tree basal cover	0%
Shrub/vine/liana basal cover	1-5%
Grass/grasslike basal cover	5-10%
Forb basal cover	1-3%
Non-vascular plants	0%
Biological crusts	0-3%
Litter	25-35%
Surface fragments >0.25" and <=3"	0-10%
Surface fragments >3"	0-5%
Bedrock	0%
Water	0%
Bare ground	0-10%

## Community 1.2 Mixed Bunchgrass Community

Idaho fescue and bluebunch wheatgrass share dominance in the Mixed Bunchgrass Community (1.2). Other grass species, which are more tolerant to grazing and likely to increase compared to the Bluebunch Community, include Sandberg bluegrass (*Poa secunda*), Cusick's bluegrass (*Poa cusickii*), prairie Junegrass (*Koeleria macrathana*), western/thickspike wheatgrass (*Pascopyrum smithii*, *Elymus lanceolatus*), and needle and thread (*Hesperostipa comata*). Some increaser forbs species include western yarrow (*Achillea millefolium*), Hoods phlox (*Phlox hoodii*), scarlet globemallow (*Sphaeralcea coccinea*), hairy goldenaster (*Heterotheca villosa*), prairie smoke (*Geum triflorum*), and pussytoes (*Antennaria* spp.). Fringed sagewort may also increase under prolonged drought or heavy grazing and can respond to precipitation that falls in July and August.

**Resilience management.** Idaho fescue tolerates grazing pressure better than bluebunch wheatgrass and Columbia needlegrass. The growing point for bluebunch wheatgrass is several inches above the ground, making them very susceptible to continued close grazing (Smoliack, et al 2006), while Idaho fescue's growing point tend to be near the plant base. These grasses increases in species composition when more palatable and less grazing tolerant plants decrease due to overgrazing, drought, or intense fire. Heavy, continuous grazing will reduce plant cover, litter, and soil organic matter. Timing of grazing is important on this site as grazing bluebunch wheatgrass in summer season has proven to negatively impact seasonal regeneration, especially on the drier sites. Bare ground will increase which may increase soil erosion. Litter and mulch will be reduced as plant cover declines. As long as bluebunch wheatgrass is still a dominant species of total biomass production, the site can return to the Bluebunch Community (Pathway 1.2A) under proper grazing management and favorable growing conditions. In this community, proper grazing management is a grazing rotation that favors bluebunch wheatgrass. This grazing management plan would include conservative grazing use with light to moderate grazing use during the critical growing season which is early to mid-summer (boot stage of the plant) or preferably dormant grazing use. (Wilson et al. 1966; McLean and Wikeem 1985) Over time, Idaho fescue, needle and thread, and western wheatgrass will

increase until they make up the majority of species composition. Once bluebunch wheatgrass has been reduced to less than 20 percent by dry weight it may be difficult for the site to recover to Bluebunch Community (1.1). The risk of soil erosion increases when canopy cover decreases. As soil conditions degrade, there will be loss of organic matter, reduced litter, and reduced soil fertility. Degraded soil conditions increase the difficulty of reestablishing bluebunch wheatgrass preventing the return to the Bluebunch Community (1.1). The Mixed Bunchgrass Community (1.2) is considered the At-Risk Plant Community for this ecological site. When overgrazing continues increases species such as needle and thread and native forb species will become more dominant and this triggers the change to the Altered State (2) or the Degraded State (3). Until the Mixed Bunchgrass Community (1.2) crosses the threshold into the Mixed Sagebrush Community (2.1) or the Invaded Community (4.1), this community can be managed toward the Bluebunch Community (1.1) using prescribed grazing and strategic weed control. It may take several years to achieve this recovery, depending on growing conditions, vigor of bluebunch and other mid-statured bunchgrass plants, and the aggressiveness of the weed treatments (if necessary).

### **Dominant resource concerns**

- Sheet and rill erosion
- Plant productivity and health
- Plant structure and composition
- Terrestrial habitat for wildlife and invertebrates

### **Pathway 1.1A**

#### **Community 1.1 to 1.2**

Mid-statured bunchgrasses lose vigor with improper grazing (see definition below), extended drought, or unusually hot fire. When vigor declines in response to disturbances such as these, bunchgrass basal areas will decrease in size while species with higher grazing tolerance (primarily Idaho fescue) increase in vigor and production as they access the resources previously used by bluebunch wheatgrass. The decrease of bluebunch wheatgrass to less than 30 percent composition indicates that the plant community has shifted to the Mixed Bunchgrass Community (1.2). The driver for community shift 1.1A is improper grazing management or prolonged drought. This shift is triggered by the loss of vigor of bluebunch wheatgrass, soil erosion, or prolonged drought coupled with improper grazing. Blaisdell (1958) stated that drought and warmer than normal temperatures are known to advance plant phenology by as much as one month. During drought years, plants may be especially sensitive or in a critical stage of development earlier than expected.

**Context dependence.** Improper grazing on this ecological site is defined as grazing utilization that exceeds moderate use (less than 50 percent grazing use) or multiple grazing events of a plant in the same growing season without rest. Associated with grazing intensity is timing of grazing. Bluebunch wheatgrass's critical grazing period is late spring.

### **Pathway 1.2A**

#### **Community 1.2 to 1.1**

The Mixed Bunchgrass Community (1.2) will return to the Bluebunch Community (1.1) with proper grazing management and appropriate grazing intensity. Favorable moisture conditions will facilitate or accelerate this transition. It may take several years of favorable conditions for the community to transition back to a bluebunch dominated state. The driver for this community shift (1.2A) is increased vigor of bluebunch wheatgrass to the point that it represents more than 20 percent of species composition. The trigger for this shift is the change in grazing management favoring bluebunch wheatgrass. In general, conservative grazing management styles such as deferred or rest rotations utilizing moderate grazing (less than 50 percent grazing use) with favorable growing conditions like cool, wet springs are these triggers. These systems tend to promote increases in soil organic matter which also promotes microfauna and increased infiltration rates. Inversely, long periods of rest at a time when this State is considered to be stable may not result in an increase in bluebunch wheatgrass. It has been suggested (Noy-Meir 1975) that these long periods of rest or underutilization may actually drive the system to a lower level of stability by creating large amounts of standing biomass, dead plant caudex centers, and gaps in the plant canopy.

### **Conservation practices**

Prescribed Burning
--------------------

## State 2

### Altered State



**Figure 11. White flowers are mountain deathcamas (*Zigadenus elegans*); a poisonous increaser plant.**

State 2 is characterized by having less than 15 percent bluebunch wheatgrass by dry weight. It is represented by 2 communities that differ in the percent composition of Idaho fescue and needle and thread, overall production, and soil degradation. Production in this State can be similar to the Reference State (1). Some native plants tend to increase under prolonged drought and/or heavy grazing practices. A few of these species may include Idaho fescue, needle and thread, Sandberg bluegrass, Cusick's bluegrass, scarlet globemallow, hairy goldenaster, and fringed sagewort. Poisonous plants such as lupine (*Lupinus* spp) and mountain deathcamas (*Zigadenus elegans*) may also increase under these conditions also.

### Community 2.1

#### Mixed Sagebrush Community

Needle and thread and Idaho fescue dominate this Mixed Sagebrush Community (2.1). Bluebunch wheatgrass comprises up to 15 percent of species composition by dry weight and the remaining mid-statured bunchgrasses plants tend to be scattered and low in vigor. Increaser and invader species will be more common. Increaser forb species include hairy goldenaster, Missouri goldenrod, stonecrop, lupine, and yarrow. It is not uncommon for a minor component of invader species such as dandelion and goatsbeard to be present. This creates more competition for bluebunch wheatgrass and other decreaser grasses, making it difficult for them to quickly respond to a change in grazing management alone. Therefore, an input of energy is required for the community to return to the Reference State (1). Wind and water may be eroding soil from the plant interspaces. Soil fertility is reduced and soil surface erosion resistance has declined compared to the Reference State (1). Long-term grazing mismanagement with continuous growing-season pressure will reduce productivity of the site and lead to an increase of bare ground. Suppression of fire can also promote shrub growth, increasing plant interspaces. Once plant cover is reduced, the site is more susceptible to erosion and degradation of soil properties. Soil erosion or reduced soil fertility will result in reduced plant production. This soil erosion or loss of soil fertility indicates the transition to the Altered State (2), because it creates a threshold requiring input of energy to return to the Reference State (1). Transition to the Mixed Sagebrush Community (2.1) may be exacerbated by extended drought conditions. Big sagebrush steppe communities historically had moderate fuel loadings and were characterized by 10 to 70 year fire return interval (often less than 30 years), that produced a mosaic of burned and unburned lands (Bunting, et.al. 1987). Following fire on the fine-textured soils, the perennial bunchgrasses recovered in a few years and were present to fuel a subsequent fire. Conversely, extensive wildfires burning under hot-dry conditions would have resulted in nearly complete destruction of scattered sagebrush (Arno and Gruell 1983). Winterfat is tolerant of low intensity fire but will kill with a hot fire (Pellant 1984). This community crossed a threshold from the Mixed Bunchgrass Community (1.2) due to the erosion of soil, vegetation composition, loss of soil fertility, or degradation of soil conditions. This results in a critical shift in the ecology of the site. The effects of soil erosion can alter the hydrology, soil chemistry, soil microorganisms, and soil structure to the point where intensive restoration is required to restore the site to another state or community. Changing grazing management, alone, may not create sufficient



improvement to restore the site if decreaser species are greatly reduced. Dormaar (1997) stated that with decreased grazing pressure, a needle and thread plant community did not change species composition but the content of the soil carbon increased. It will require a considerable input of energy to move the site back to the Reference State (1). This state has lost soil or vegetation attributes to the point that recovery to the Reference State (1) will require reclamation efforts, i.e., soil rebuilding, intensive mechanical treatments, and reseeded. The transition to this state could result from overgrazing and fire suppression, especially repeated early season grazing coupled with extensive drought. If heavy grazing continues, plant cover, litter, and mulch will continue to decrease and bare ground will increase exposing the soil to accelerated erosion. Litter and mulch will move off-site as plant cover declines. The Mixed Sagebrush Community will then shift to a Shortgrass-Shrub Community (2.2). Continued overgrazing will drive the community to a Degraded State (3). Introduction or expansion of invasive species will further drive the plant community to the Invaded State (4).

## **Community 2.2**

### **Shortgrass-Shrub Community**

With continued mismanagement of grazing, especially coupled with prolonged drought, Idaho fescue will decrease in vigor. The bunchgrasses will decline in production as plants die or become smaller, and species with higher grazing tolerance (such as western wheatgrass) increase in vigor and production as they respond to resources previously used by the bunchgrasses. These less desirable, shorter rooted species will become codominant with the bunchgrasses. Mid-statured grasses such as bluebunch wheatgrass, Columbia needlegrass, and green needlegrass will exist within taller shrubs where they are protected from grazing animals. Shrubs will become more competitive for limited moisture as bare ground and soil erosion increase. This state may exhibit conditions where livestock and wildlife are also overconsuming shrubs.

### **Pathway 2.1A**

#### **Community 2.1 to 2.2**

The driver for community shift 2.1A is continued overgrazing. Overgrazing on this site is defined by grazing utilization over 60 percent or season-long grazing where livestock can graze regrowth. This shift is triggered by continued loss of bunchgrass vigor, especially the remaining Idaho fescue and needlegrasses. The mid- and short-statured grasses will become more competitive and become co-dominant with the bunch grasses. Shrubs will increase in canopy cover to 25 to 30 percent. A shift in shrub dominance of big sagebrush to three-tip sagebrush (*Artemisia tripartita*) may also occur.

### **Pathway 2.1B**

#### **Community 2.2 to 2.1**

If grazing management is implemented, Idaho fescue may regain its vigor and move towards the Mixed Sagebrush Community (2.1). This will give grasses an advantage over invading shrubs before too much competition takes place. Since the transition from Plant Community 2.1 to Plant Community 2.2 was likely caused by repeated heavy utilization, a conservative grazing plan, where utilization is reduced at or below moderate utilization with rest or deferment incorporated, will aid in recovery. Van Poolen and Lacey (1979) found that forage production increased by an average of 35 percent on western ranges when converting from heavy utilization to moderate utilization (less than 50 percent). Shrub removal and favorable growing conditions can accelerate this process. If the site contains excess Wyoming big sagebrush (*Artemisia tridentata* spp. *Wyomingensis*), a low intensity fire or mechanical treatment (Wambolt 1986) could reduce shrub competition and allow for increased vigor and the reestablishment of grass species.

## **State 3**

### **Degraded State**

Degraded State is characterized by a near complete lack of mid-statured bunchgrasses. Idaho fescue, needle and thread, Sandberg bluegrass and prairie Junegrass are dominant grasses. Increaser shrubs nearly replace larger shrub species. Remaining larger shrub species are heavily hedged and may have been replaced with three-tip sagebrush. This State is likely a terminal state (e.g. restoration will likely be impossible or unsuccessful without major financial and energy inputs).



## **Community 3.1**

### **Shortgrass Community**

This state is characterized by soil surface degradation and little plant soil surface cover. Soil loss continues and subsequent loss of soil organic matter create conditions where native perennial grasses are reduced. Grass and forb cover may be sparse with obvious rill erosion between plant bases. Needle and thread and Idaho fescue exist in small patches. This could occur due to overgrazing (failure to adjust stocking rate to declining forage production due to increased invasive dominance), long-term lack of fire (if dense Wyoming big sagebrush occurs), or introduction of invasive species. In the most severe stages of degradation, there is a significant amount of bare ground, and large gaps occur between plants. Potential exists for soils to erode to the point that irreversible damage may occur. This is a critical shift in the ecology of the site. Soil erosion combined with lack of organic matter deposition due to sparse vegetation create changes to the hydrology, soil chemistry, soil microorganisms, and soil structure to the point where intensive restoration is required to restore the site to another state or community. Changing management (i.e., improving grazing management) cannot create sufficient change to restore the site. The forb component changes to be dominated by spiny phlox (*Phlox hoodii*) and shrub canopy cover is usually greater than 20 percent. Big sagebrush is replaced with a dominant community of low sagebrush (*Artemisia arbuscula*), three-tip sagebrush, broom snakeweed, rubber rabbitbrush, fringed sagewort, and plains pricklypear cactus. This state has lost soil or vegetation attributes to the point that recovery to the Reference State will require extensive reclamation efforts, i.e. soil rebuilding, intensive mechanical treatments, and reseeding. Grazing management such as a rest rotation will not return this state to Reference without reclamation efforts. This plant community may be in a terminal state that will not return to the reference state because of degraded soil conditions and loss of higher successional native plant species. Key factors of approach to transition: Decrease in grass canopy cover and production, increase of shrub canopy cover, increases in mean bare patch size, increases in soil crusting, decreases in cover of cryptobiotic crusts, decreases in soil aggregate stability, or evidence of erosion including water flow patterns and litter movement.

## **State 4**

### **Invaded State**

The Invaded State is identified by being in the exponential growth phase of invader abundance where control is a priority. Dominance (or relative dominance) of noxious/invasive species reduces species diversity, forage production, wildlife habitat, and site protection. A level of 10 percent invasive species composition by dry weight indicates the point that a substantial energy input such as herbicide or mechanical removal will be required to create a shift to the grassland state even with a return to proper grazing management or favorable growing conditions. Prescriptive grazing that specifically focuses on grazing of the invasive plant can be used to manage invasive species. In some instances, carefully targeted grazing (sometimes in combination with other treatments) can reduce or maintain species composition of invasive species.

## **Community 4.1**

### **Invaded Community**

Communities in this state may be structurally indistinguishable from the Reference State except that invasive/noxious species exceed 10 percent of species composition by dry weight. This state may also include a community similar to the Degraded State (3) except that invasive/noxious species exceed 10 percent of species composition by dry weight. Although there is no research to document the level of 10 percent, this is estimated to be the point in the invasion process following the lag phase based on interpretation of Masters and Sheley, 2001. For aggressive invasive species (i.e., spotted knapweed) the threshold could be less than 10 percent. Early in the invasion process there is a lag phase where the invasive plant populations remain small and localized for long periods before expanding exponentially (Hobbs and Humphries 1995). Production in the invaded community may vary greatly based on the severity of invasion and potential subsequent effects on species composition. A site dominated by Kentucky bluegrass or spotted knapweed, where soil fertility and chemistry remain near reference, may have production near that of the reference community. A site with degraded soils and an infestation of cheatgrass may produce only 10 to 20 percent of the reference community. Once invasive species dominate the site, either in species composition by weight or in their impact on the community the threshold has been crossed to the Invaded State (4). As invasive species such as spotted knapweed, cheatgrass, and leafy spurge become established, they become very difficult to eradicate. Therefore considerable effort should be placed in preventing plant communities from crossing the threshold to the Invaded State (4) through early detection and proper

management. Preventing new invasions is by far the most cost-effective control strategy, and typically places an emphasis on education. Control measures used on the noxious plant species impacting this ecological site include chemical, biological, and cultural (burning, mowing, cutting) control methods. The best success has been found with an integrated pest management (IPM) strategy that incorporates one or several of these options along with education and prevention efforts (DiTomaso 2000)

## **State 5**

### **Conifer Encroached State**

Rocky Mountain juniper (*Juniperus scopulorum*) and/or Douglas fir (*Pseudotsuga menziesii*) encroachment is common on this ecological site and is generally focused in areas with east and north facing slopes. Under the Reference State, conifers may exist on this site however this is limited to two trees per acre on north and east facing slopes and is considered a trace canopy cover. Conifer encroachment likely occurs in the late stages of the Altered State (State 2) where there is an increase of bare ground and reduced vigor of mid-statured bunchgrasses due to a combination of factors. Fire suppression and improper grazing management are the two most common triggers. The exact conditions in which juniper begins to encroach vary; however, the trend points to a combination of one or more of the following: moderately heavy to heavy grazing, reduced (non-existent) fire frequency, increased atmospheric carbon, and generally warmer climate (compared to that of pre-settlement). When heavy grazing occurs, areas in the plant canopy open allowing for seed dispersal by birds or overland flow via rills on neighboring sites. The effects of conifer encroachment are not immediately noticed; however, over time as conifer canopy increases, light and water interception increase which reduce opportunities for herbaceous plants. Literature (Barrett, 2007) suggests that for precipitation to penetrate the juniper canopy, events must be greater than 0.30 inches. Increase juniper canopy creates perching sites for predators which reduces site suitability for greater sage grouse. Studies (Miller et al 2000), based in a similar community to the Conifer Encroached communities of this LRU, suggest following a phased approach to characterize the stand. Not unlike the Western Juniper community discussed in Miller et al, these communities of Montana exhibit three different phases based, at this time, on qualitative information.

### **Community 5.1**

#### **Conifer Community Phase I**

Phase I (Early) is defined by actively expanding conifer cover with generally less than 5 percent canopy cover with trees limbs generally touch the ground. This early stage generally has not lost its hydrologic functions, however herbaceous plant communities may show signs of reduced production and species richness. Control methods include mechanical removal and prescribed fire. Prescribed fire is still effective management in this phase as it still contains the necessary native plants for recovery. The tree canopy density is also low enough that risk of a dangerously hot fire is reduced.

### **Community 5.2**

#### **Conifer Community Phase II**

Phase II (Mid Stage) is still actively expanding, however canopy cover may reach up to 15 percent. Due to the more mature trees present, seed production is very high. This Mid Phase begins to highly restrict herbaceous and shrubby plants. Conifers tend to be codominant with herbaceous plants. Hydrology is departing from reference with rills becoming longer and, in isolated areas, erosional gullies may begin to form. Control methods of the Mid Stage should focus on mechanical treatment (chainsaw cutting or mastication) as there is a high risk of catastrophic and potentially hot, sterilizing fire. Post treatments of slash are currently being evaluated but typically include chipping, lop-and-scatter, and slash piling. Lop-and-scatter and slash pile treatments are often burned to remove excess woody debris. Qualitative assessments of these treatments suggests native bunchgrasses respond immediately in this stage and post treatment grazing management including two growing seasons of rest may be necessary while these plants increase their basal areas.

### **Community 5.3**

#### **Conifer Community Phase III**

Phase III (Late stage) is where juniper cover exceed 20 percent and has slowed to resemble a forest condition. Lower limbs of trees begin to die and the rangeland shrub cover is nearly lost. Traveling through this community is

increasingly difficult. Conifers become the dominant plant with herbaceous plant production greatly decreased. Bare ground increases and hydrologic function is nearly lost compared to a grass/shrub community. Late Stage Phase should focus more on restoration than control as the necessary plants will likely not be present to cross the threshold back to the Reference State. Site stability and hydrologic function are lacking in this phase so mechanical removal of conifer will be necessary and prescribed fire is not suggested. Post treatment rest from grazing is important as remaining native grasses will be reduced in stature and will be susceptible to accidental overgrazing as livestock will seek out these tender plants. After a rest period, light and brief grazing may help initiate tillering of bunchgrasses.

### **Pathway 5.1A** **Community 5.1 to 5.2**

Over time Phase I community expands in both height and width. The driver for this pathway is primarily lack of fire; however, heavy grazing (utilization that exceeds 50 percent) can help reduce herbaceous competition and expose soil for seed contact. Increase atmospheric carbon dioxide has also been shown to increase coniferous tree and shrub growth (Archer et al. 2017).

### **Pathway 5.2B** **Community 5.2 to 5.3**

Over time Phase II community expands in both height and width. The driver for this pathway is primarily lack of fire; however, heavy grazing (utilization that exceeds 50 percent) can help reduce herbaceous competition and expose soil for seed contact. Increase atmospheric carbon dioxide has also been shown to increase coniferous tree and shrub growth (Archer et al. 2017).

### **Transition T1B** **State 1 to 2**

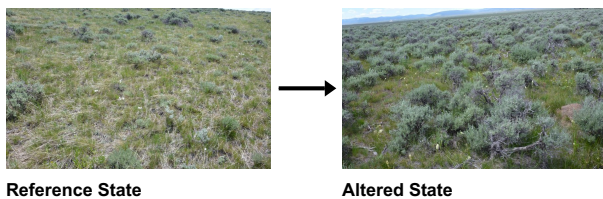

The Reference State (1) transitions to the Altered State (2) if bluebunch wheatgrass decreases to 15 percent, by dry weight, or if bare ground cover is increases by 10 percent . The driver for this transition is loss of taller bunchgrasses, which creates open areas in the plant canopy with bare soil. Soil erosion results in decreased soil fertility, driving transitions to the Altered State. There are several other key factors signaling the approach of transition T1B: increases in soil physical crusting, decreases in cover of cryptogamic crusts, decreases in soil surface aggregate stability or evidence of erosion including water flow patterns, development of plant pedestals, and litter movement. The trigger for this transition is improper grazing management and long-term drought leading to a decrease in bluebunch wheatgrass composition to 15 percent and reduction in total plant canopy cover.

### **Transition T1C** **State 1 to 3**

The Reference State (1) transitions to the Degraded State (3) when bluebunch wheatgrass is completely removed from the plant community. Idaho fescue and needle and thread are subdominant to short-statured bunchgrasses such as Sandberg and Cussick's bluegrass. The trigger for this transition is loss of most mid-statured bunchgrasses, which creates open spaces with bare soil. Soil erosion as a result of increased bare ground and shallow roots decreases soil fertility, driving transitions to the Degraded State. There are several other key factors signaling the approach of transition T1C: increases in soil physical crusting, decreases in cover of cryptogamic crusts, decreases in soil surface aggregate stability or evidence of erosion including rills, water flow patterns, development of plant pedestals, and litter movement. The driver for this transition is improper grazing management, intense or repeated fires, or heavy human disturbance. Rapid transition is generally realized where livestock are confined to small pastures for long periods of time such as feeding areas, horse pastures, and bull lots. Degradation may be so extreme that traditional restoration methods may not be successful and require extensive

mechanical and financial inputs.

## Transition T1D

### State 1 to 4

Healthy plant communities are most resistant to invasion; however, sometimes regardless of grazing management, without some form of active weed management (chemical, mechanical, or biological control), the Reference State (1) can transition to the Invaded State (4) in the presence of aggressive invasive species such as spotted knapweed, leafy spurge, and cheatgrass. The Central Rocky Mountains tend to resist invasion; but recent dry climate cycles, repeated heavy grazing or intense human activities can open the interspaces of the bunchgrass community and allow for encroachment. Long-term stress conditions for native species (e.g., overgrazing, drought, and fire) accelerate this transition. If populations of invasive species reach critical levels, the site transitions to the Invaded State. The trigger for this transition is the presence of aggressive invasive species with invasive species composition by dry weight approaching 10 percent.

## Transition T1E

### State 1 to 5

Conifer tree/shrub count exceeds two stems per acre. The trigger of crossing a threshold is the presence of seeds and/or other viable material of these tree species.

## Restoration pathway R2A

### State 2 to 1



Altered State

Reference State

The Altered State (2) has lost soil or vegetation attributes to the point that recovery to the Reference State (1) will require reclamation efforts such as soil rebuilding, intensive mechanical and cultural treatments, and/or revegetation. Examples of mechanical treatment may be brush control while cultural treatments may include prescribed grazing, targeted brush browsing, or prescribed burning. Grazing practices that promote bluebunch wheatgrass is primarily light to moderate grazing during the critical season (late June through July) or fall and dormant season of moderate however heavy utilization may not have negative impacts (Dormaar and Willms 1998) though grazing should match the species composition of the site prior to exceeding moderate utilization. Low intensity prescribed fires to reduce competitive increaser plants such as needle and thread and Sandberg bluegrass. A low intensity fire will also reduce big sagebrush densities. In areas with potential of annual grass infestation, fire should be carefully planned or avoided. The drivers for this restoration pathway are reclamation efforts along with proper grazing management.

## Conservation practices

Brush Management
Prescribed Burning
Fence
Livestock Pipeline
Prescribed Grazing
Grazing Land Mechanical Treatment
Range Planting

## Transition T2A

### State 2 to 3

As improper grazing continues, vigor of bunchgrasses will decrease, and the shorter grasses and shrubs will increase towards the Degraded State (3). Improper grazing management for this state can be defined as grazing events that exceed moderate grazing (40 to 50 percent grazing use), grazing season that exceeds half of the growing season, or grazing events that consume the plant regrowth in the same growing season. Highly managed grazing events that exceed moderate grazing levels for short timeframes are generally not included in this definition due to increased rest periods between these grazing events. Additionally, prolonged drought will provide a competitive advantage to shrubs allowing them to become co-dominant with grasses. Shrub canopy will increase but canopy height will be low. Mat forming forbs will also increase. Key transition factors: increase of native shrub canopy cover; reduction in bunchgrass production; decrease in total plant canopy cover and production; increases in mean bare patch size; increases in soil crusting; decreases in cover of cryptobiotic crusts; decreases in soil aggregate stability; and evidence of erosion including water flow patterns and litter movement.

### **Transition T2B State 2 to 4**

Invasive species can occupy the Altered State (2) and drive it to the Invaded State (4). The Altered State is at risk if invasive seeds and other viable material when present. The driver for this transition is more than 10 percent dry weight of invasive species. The trigger is the presence of seeds and other viable material of invasive species.

### **Transition T2D State 2 to 5**

Conifer tree/shrub count exceeds two stems per acre. The trigger of crossing a threshold is the presence of seeds and other viable material of these tree species.

### **Restoration pathway R3B State 3 to 1**

The Degraded State (3) has lost soil or vegetation attributes to the point that recovery to the Reference State (1) will require reclamation efforts, such as soil rebuilding, intensive mechanical treatments, and/or revegetation. Studies suggest (Whitford et al 1989) a mulch with high carbon to nitrogen ratio such as wood chips or bark in low moisture scenarios can be beneficial for slow mobilization of plant available nitrogen. Biochar may also be added to the system to improve Soil Organic Carbon (SOC) which should improve Cation Exchange Capacity (CEC), microbial activity, and hydrologic conductivity (Stavi 2012). The drivers for the restoration pathway are removal of increaser species, restoration of native bunchgrass species, persistent management of invasives and shrubs, and proper grazing management. Without continued control, invasive and shrub species are likely to return (probably rapidly) due to presence of seeds and/or other viable material in the soil and management related increases soil disturbance.

#### **Conservation practices**

Brush Management
Prescribed Burning

### **Restoration pathway R3A State 3 to 2**

Since the deep-rooted bunchgrass plant community has been removed, restoration to the Altered State (2) is unlikely unless a seed source is available. If a sufficient amount of bunchgrass remains on the site, chemical application or biological control in conjunction with proper grazing management, can reduce the amount of shrubs and invasive species and restore the site to the Shortgrass Community (2.2). Grazing management strategies that follow light grazing and allow for long periods of rest will allow for limited recovery of remaining bunchgrasses, however grazing management alone may not directly result in restoration. Restoration methods such as reseeding may be necessary Low intensity fire can be utilized to reduce shrub competition and allow the reestablishment of grass species. Caution must be used when considering fire as a management tool on sites with fire tolerant shrubs such as rubber rabbitbrush, as these shrubs will re-sprout after a burn. Broom snakeweed and fringed sagewort

may or may not re-sprout depending on conditions (USDA Forest Service 2011).

### **Transition T3A** **State 3 to 4**

Invasive species can occupy the Degraded State (3) and drive it to the Invaded State (4). The Degraded State is at risk of this transition occurring if invasive seeds or viable material are present. The driver for this transition is presence of critical population levels of invasive species. The trigger is the presence of seeds or viable material of invasive species. This state has sufficient bare ground that the transition could occur simply due to presence or introduction of invasive seeds or viable material. This is particularly true of aggressive invasive species such as spotted knapweed and cheatgrass. This transition could be assisted by overgrazing (failure to adjust stocking rate to declining forage production), long-term lack of fire, or extensive drought.

### **Transition T3C** **State 3 to 5**

Conifer tree/shrub count exceeds 2 stems per acre. The trigger of crossing a threshold is the presence of seeds and/or other viable material of these tree species.

### **Restoration pathway R4C** **State 4 to 1**

Restoration of the Invaded State (4) to the Reference State (1) requires substantial energy input. The drivers for the restoration pathway are removal of invasive species, restoration of native bunchgrass species, persistent management of invasive species, and proper grazing management. Without continued control, invasive species are likely to return (probably rapidly) due to the presence of seeds and other viable material in the soil, and management related practices that increase soil disturbance. If invaded by conifer encroachment, treatment depends on the condition of the rangeland. See Plant community 4.1 for alternative measures of restoration. Sites that have transitioned from the Degraded State (3) to the Invaded State (4) may be severely lacking soil and vegetative properties that will allow for restoration to the Reference State. Hydrologic function damage may be irreversible especially with accelerated gully erosion.

### **Restoration pathway R4B** **State 4 to 2**

If invasive species are removed before remnant populations of bunchgrasses are drastically reduced the Invaded State (4) can return to the Altered State. The driver for the reclamation pathway is weed management with possible reseedling. Continued Integrated Pest Management (IPM) will be required because many of the invasive species that can occupy the Invaded State have extended dormant seed life. The trigger is invasive species control.

### **Restoration pathway R4A** **State 4 to 3**

If invasive species are removed, the site could return to the Degraded State (3). Without sufficient remnant populations of preferred plants the Invaded State (4) is not likely to return to any of the other states. The driver for the reclamation pathway is weed management without reseedling. The trigger is invasive species control. The invading species cause a significant increase in soil loss due to lack of ground cover (Lacey et al. 1989).

### **Transition T4B** **State 4 to 5**

Canopy cover of conifer tree/shrub cover exceeds two stems per acre. The threshold change is triggered by the presence of seeds and other viable material of invasive species.

### **Restoration pathway R5A** **State 5 to 1**

Depending on the level of conifer canopy cover and its impact on rangeland health, restoration efforts may simply focus on removal of coniferous trees and shrubs to restore the Conifer Encroached State (5) to the Reference State (1). If utilizing the phases, established by Miller et al, management and restoration methods will vary. A large majority of the conifer encroachment in MLRA 43B will fall into the two early phases established by Miller et al. Phase I exhibits None or Slight to Moderate departures from rangeland health where removal of the conifers via Brush Management or Prescribed fire combined. If mechanical removal of conifers is utilized, no grazing management is needed assuming relatively conservative management had been used prior to treatment. If prescribed fire is utilized, short term grazing deferment and rest is suggested. Given a short time, removal of a Phase I encroachment, will recover to Reference. Proactive pest management is encouraged. Phase II Encroachment requires a more intense mechanical removal of trees/shrubs. Prescribed fire is not a feasible method of control because this community is at-risk of catastrophic fire due to canopy density. Phase II displays a Moderate departure from Reference suggesting an overall instability of the site such as reduced herbaceous production, reduced functional/structural groups (e.g. reduced mid-statured bunchgrasses), increase rill frequency and length, and possibly increased bare ground. Increased post treatment grazing management may be necessary. Grazing management may be as simple as short-term growing season deferment however long-term rest may be necessary in the latter stages of Phase II encroachment. Latter stages of Phase II encroachment will likely require some short term erosion mitigation such as straw wattles as well as range planting or critical area planting to re-establish any loss of native herbaceous plants particularly mid-statured cool-season bunchgrasses. Phase III Encroachment canopy cover resembles forested sites with larger trees and shrubs. Forest management style tree removal (woody debris and logs removed from the site) will be necessary prior to any prescribed burning as to prevent the fire from burning too hot. The result of a prescribed fire on this site are typically unknown as seed sources of native herbaceous plants are usually limited to small patches. Since herbaceous plants will likely be depleted under a Phase III encroachment, there is an opportunity for large areas of bare ground, increased rill and potentially gully erosion. Post-treatment will require range planting or critical area seeding, erosion control, pest management, and possibly soil carbon amendments (biochar). Grazing management (primarily rest) will be necessary to ensure seedling establishment.

### **Restoration pathway R5B State 5 to 2**

The Conifer Encroached State (5) Phases I and II will often resemble early stages of the Mixed Sagebrush Community (2.1) of the Altered State (2) on this site. If utilizing the phases established by Miller et al, management and restoration methods will vary. A large majority of the conifer encroachment in MLRA 43B will fall into the two early phases established by Miller et al. Phase I may exhibit None or Slight to Moderate departures from rangeland health following removal of the conifers with Brush Management or Prescribed fire combined. If mechanical removal of conifers is utilized, no grazing management is needed assuming relatively conservative management had been used prior to treatment. If prescribed fire is utilized, short-term grazing deferment and rest is suggested. Given a short time, removal of a Phase I encroachment, will recover to Reference. Proactive pest management is encouraged. Phase II Encroachment may require a more intense mechanical removal of trees/shrubs because prescribed fire is not a feasible method of control as this community may be at-risk of catastrophic fire due to canopy density. Phase II displays a Moderate departure from Reference suggesting an overall instability of the site such as reduced herbaceous production, reduced functional/structural groups (e.g. reduced mid-statured bunchgrasses), increase rill frequency and length, and possibly increased bare ground. Increased post treatment grazing management may be necessary. Grazing management may be as simple as short term growing season deferment; however long term rest may be necessary in the latter stages of Phase II encroachment. Latter stages of Phase II encroachment will likely require some short term erosion mitigation such as straw wattles as well as range planting or critical area planting to re-establish any loss of native herbaceous plants particularly mid-statured cool-season bunchgrasses. Phase III Encroachment canopy cover resembles forested sites with larger trees and shrubs. Forest management style tree removal (woody debris and logs removed from the site) will be necessary prior to any prescribed burning as to prevent the fire from burning too hot. The result of a prescribed fire on this site are typically unknown as seed sources of native herbaceous plants are usually limited to small patches. Since herbaceous plants will likely have been depleted under a Phase III encroachment, there is an opportunity for large areas of bare ground, increase rill and potentially gully erosion. Post treatment will require range planting or critical area seeding, erosion control, pest management, and possibly soil carbon amendments (biochar). Grazing management (primarily rest) will be necessary to ensure new seedling establishment.

### **Restoration pathway R5C**

## **State 5 to 3**

The Conifer Encroached State (5) Phases II and III will likely resemble the Degraded State (3) on this site due to reduced mid-statured bunchgrasses. If utilizing the phases established by Miller et al, management and restoration methods will vary. A large majority of the conifer encroachment in MLRA 43B will fall into the two early phases of Miller's Phases. This Restoration Pathway is exceedingly rare as it is typically not cost effective for land managers to manage for a degraded state. Phase I exhibits None or Slight to Moderate departures from rangeland health where removal of the conifers with brush management or prescribed fire combined. If mechanical removal of conifers is utilized, no grazing management is needed assuming relatively conservative management had been used prior to treatment. If prescribed fire is utilized, short term grazing deferment and rest is suggested. Given a short time, removal of a Phase I encroachment, will recover to Reference. Proactive pest management is encouraged. Phase II Encroachment requires a more intense mechanical removal of trees/shrubs with prescribed fire not being a feasible method of control because this community is at risk of catastrophic fire due to canopy density. Phase II displays a moderate departure from Reference suggesting an overall instability of the site such as reduced herbaceous production, reduced functional/structural groups (e.g. reduced mid-statured bunchgrasses), increase rill frequency and length, and possibly increased bare ground. Increased post treatment grazing management may be necessary. Grazing management may be as simple as short term growing season deferment however long term rest may be necessary in the latter stages of Phase II encroachment. Latter stages of Phase II encroachment will likely require some short term erosion mitigation such as straw wattles as well as range planting or critical area planting to re-establish any loss of native herbaceous plants particularly mid-statured cool season bunchgrasses. Phase III Encroachment canopy cover resembles forested sites with larger trees and shrubs. Forest management style tree removal (woody debris and logs removed from the site) will be necessary prior to any prescribed burning to prevent the fire from burning too hot. The result of a prescribed fire on this site are typically unknown as seed sources of native herbaceous plants are usually limited to small patches. Since herbaceous plants will likely have been depleted under a Phase III encroachment, there is an opportunity for large areas of bare ground, increased rill and potentially gully erosion. Post treatment will require range planting or critical area seeding, erosion control, pest management, and possibly soil carbon amendments (biochar). Grazing management (primarily rest) will be necessary to ensure any new seedling establishment.

## **Restoration pathway R5D**

### **State 5 to 4**

If utilizing the phases established by Miller et al management and restoration methods will vary. A large majority of the conifer encroachment in MLRA 43B will fall into the early two phases of Miller's Phases. This Restoration Pathway is exceedingly rare as it is typically not cost effective for land managers to manage for the Invaded State. Phase I may exhibit None-Slight to Moderate departures from rangeland health where removal of the conifers via Brush Management and/or Prescribed fire combined. If mechanical removal of conifers is utilized, no grazing management is needed assuming relatively conservative management had been used prior to treatment. If prescribed fire is utilized, short term grazing deferment and/or rest is suggested. Given a short time removal of a Phase I encroachment will recover to Reference. Proactive pest management is absolutely necessary with presence of invasive herbaceous species. Phase II Encroachment may require a more intense mechanical removal of trees/shrubs because Prescribed Fire is not a feasible method of control because the community may be at risk of catastrophic fire due to canopy density. Phase II displays a Moderate departure from Reference suggesting an overall instability of the site such as reduced herbaceous production, reduced functional/structural groups (e.g. reduced mid-statured bunchgrasses), increase rill frequency and length, and possibly increased bare ground. Increased post treatment grazing management may be necessary. Grazing management may be as simple as short term growing season deferment however long term rest may be necessary in the latter stages of Phase II encroachment. Latter stages of Phase II encroachment will likely require some short term erosion mitigation such as straw wattles as well as range planting or critical area planting to re-establish any loss of native herbaceous plants particularly mid-statured cool-season bunchgrasses. Phase III Encroachment canopy cover resembles forested sites with larger trees and shrubs. Forest management style tree removal (woody debris and logs removed from the site) will be necessary prior to any prescribed burning to prevent the fire from burning too hot. The result of a prescribed fire on this site are typically unknown as seed sources of native herbaceous plants are usually limited to small patches. Since herbaceous plants will likely have been depleted under a Phase III encroachment, there is an opportunity for large areas of bare ground, increased rill and potentially gully erosion. Post treatment will require range planting and/or critical area seeding, erosion control, pest management, and possibly soil carbon amendments (biochar). Grazing management (primarily rest) will be necessary to ensure any new seedling establishment.



## Additional community tables

Table 8. Community 1.1 plant community composition

Group	Common Name	Symbol	Scientific Name	Annual Production (Lb/Acre)	Foliar Cover (%)
<b>Grass/Grasslike</b>					
1	<b>Mid-statured Bunchgrasses</b>			825–950	
	bluebunch wheatgrass	PSSP6	<i>Pseudoroegneria spicata</i>	400–520	25–35
	green needlegrass	NAVI4	<i>Nassella viridula</i>	60–180	1–5
	basin wildrye	LECI4	<i>Leymus cinereus</i>	0–100	0–5
	Columbia needlegrass	ACNE9	<i>Achnatherum nelsonii</i>	10–40	3–5
	spike fescue	LEKI2	<i>Leucopoa kingii</i>	0–20	0–2
	Porter brome	BRPO2	<i>Bromus porteri</i>	0–20	0–1
	rough fescue	FECA4	<i>Festuca campestris</i>	0–5	0
2	<b>Increaser Bunchgrasses and sedges</b>			125–160	
	Idaho fescue	FEID	<i>Festuca idahoensis</i>	100–180	5–10
	needle and thread	HECO26	<i>Hesperostipa comata</i>	0–60	1–5
	Sandberg bluegrass	POSE	<i>Poa secunda</i>	10–60	0–3
	sedge	CAREX	<i>Carex</i>	0–60	0–3
	prairie Junegrass	KOMA	<i>Koeleria macrantha</i>	20–40	1–2
	Cusick's bluegrass	POCU3	<i>Poa cusickii</i>	0–40	0–2
	needleleaf sedge	CADU6	<i>Carex duriuscula</i>	10–20	0–1
	timber oatgrass	DAIN	<i>Danthonia intermedia</i>	0–20	0–1
3	<b>Rhizomatous Grasses</b>			70–85	
	thickspike wheatgrass	ELLA3	<i>Elymus lanceolatus</i>	40–140	0–2
	western wheatgrass	PASM	<i>Pascopyrum smithii</i>	0–75	0–2
	plains reedgrass	CAMO	<i>Calamagrostis montanensis</i>	0–40	0–1
<b>Forb</b>					
4	<b>Forbs</b>			185–250	
	lupine	LUPIN	<i>Lupinus</i>	40–120	0–2
	American vetch	VIAM	<i>Vicia americana</i>	40–100	0–2
	sulphur-flower buckwheat	ERUM	<i>Eriogonum umbellatum</i>	0–80	0–1
	common yarrow	ACMI2	<i>Achillea millefolium</i>	20–60	0–1
	western stoneseed	LIRU4	<i>Lithospermum ruderale</i>	20–60	0–1
	goldenbanner	THERM	<i>Thermopsis</i>	0–40	0–1
	beardtongue	PENST	<i>Penstemon</i>	20–40	0–1
	spiny phlox	PHHO	<i>Phlox hoodii</i>	0–20	0–1
	rosy pussytoes	ANRO2	<i>Antennaria rosea</i>	0–20	0–1
	geranium	GERAN	<i>Geranium</i>	0–15	0–1
	false dandelion	NOTHO5	<i>Nothocalais</i>	0–15	0–1
	cinquefoil	POTEN	<i>Potentilla</i>	0–15	0–1
	Indian paintbrush	CASTI2	<i>Castilleja</i>	0–10	0–1
	northern bedstraw	GABO2	<i>Galium boreale</i>	0–10	0–1
	balsamroot	BALSA	<i>Balsamorhiza</i>	0–10	0

	elkweed	FRSP	<i>Frasera speciosa</i>	0–5	0
<b>Shrub/Vine</b>					
5	<b>Shrubs</b>			125–165	
	mountain big sagebrush	ARTRV	<i>Artemisia tridentata ssp. vaseyana</i>	5–165	5–15
	Wyoming big sagebrush	ARTRW8	<i>Artemisia tridentata ssp. wyomingensis</i>	5–165	5–15
	threetip sagebrush	ARTR4	<i>Artemisia tripartita</i>	0–60	0–2
	spineless horsebrush	TECA2	<i>Tetradymia canescens</i>	0–50	0–2
	common snowberry	SYAL	<i>Symphoricarpos albus</i>	5–40	0–1
	rubber rabbitbrush	ERNA10	<i>Ericameria nauseosa</i>	0–40	0–1
	shrubby cinquefoil	DAFR6	<i>Dasiphora fruticosa</i>	0–40	0–1
	yellow rabbitbrush	CHVI8	<i>Chrysothamnus viscidiflorus</i>	0–25	0–1
	broom snakeweed	GUSA2	<i>Gutierrezia sarothrae</i>	0–20	0–1
	Woods' rose	ROWO	<i>Rosa woodsii</i>	0–20	0–1
	chokecherry	PRVI	<i>Prunus virginiana</i>	0–20	0–1
<b>Tree</b>					
6	<b>Trees</b>			0–20	
	Douglas-fir	PSME	<i>Pseudotsuga menziesii</i>	0–10	0
	Rocky Mountain juniper	JUSC2	<i>Juniperus scopulorum</i>	0–10	0
	quaking aspen	POTR5	<i>Populus tremuloides</i>	0–10	0

## Animal community

The Droughty Ecological Site provides for a variety of wildlife habitat for an array of species. Prior to the settlement, large herds of antelope, elk and bison roamed this area. Though the bison have been replaced, mostly with domesticated livestock; elk and antelope still frequently utilize this largely intact landscape for winter habitat in areas adjacent to forest.

The relatively high grass component of the Reference Community provides excellent nesting cover for multiple neotropical migratory birds that select for open grasslands such as the Long-billed curlew and McCown's longspur.

Greater sage grouse may be present on sites with suitable habitat, typically requiring a minimum of 15 percent sagebrush canopy cover (Braun et al. 1977). The Bluebunch Community (1.1) is likely to have this minimum sagebrush cover for sage grouse presence given its moderate sagebrush canopy cover. Also, the potentially diverse forb component of the Reference State may provide the important early season (spring) foraging habitat for the Greater sage grouse. Other communities on the site with sufficient sagebrush cover may harbor sage grouse populations specifically Community 2.1 where big sagebrush populations increased under a reduced fire regime. Also as sagebrush canopy cover increases under Altered States and, to a limited extent, the Degraded State 3.1; Pygmy rabbit, Brewer's sparrow, pronghorn antelope, elk, and mule deer use may also increase.

Managed livestock grazing is suitable on this site due to the potential to produce an abundance of high quality forage. This is often a preferred site for grazing by livestock, and animals tend to congregate in these areas. In order to maintain the productivity of the site, grazing on adjoining sites with less production must be managed carefully to be sure utilization on this site is not excessive. Management objectives should include maintenance or improvement of the native plant community. Careful management of timing and duration of grazing is important. Shorter grazing periods and adequate deferment during the growing season are recommended for plant maintenance, health, and recovery. According to McLean and Wikeen 1985, early season defoliation of bluebunch wheatgrass can result in high mortality and reduced vigor of plants. They also suggest, based on prior studies, that regrowth is necessary before dormancy to reduce injury of bluebunch wheatgrass.

Grazing season has more influence on winterfat than grazing intensity. Late winter or early spring grazing is

detrimental. However, early winter grazing may actually be beneficial (Blaisdell and Holmgren 1984).

Continual non-prescribed grazing of this site is detrimental, by altering the plant composition and production over time, and will result in transition to the Altered State (2). Transition to other states will depend on duration of poorly managed grazing and other circumstances such as weather conditions and fire frequency.

The Altered State (2) is subject to further degradation to the Degraded State (3) or Invaded State (4). Management should focus on grazing management strategies that will prevent further degradation, such as seasonal grazing deferment or winter grazing where feasible. Communities within this state are still stable and healthy under proper management. Forage quantity and/or quality may be substantially decreased from the Reference State (1).

Grazing is possible in the Invaded State (4). Invasive species are generally less palatable than native grasses. Forage production is typically greatly reduced in this state. Due to the aggressive nature of invasive species, sites in the Invaded State (4) face increased risk for further degradation to the invasive dominated community. Grazing has to be carefully managed to avoid further soil loss and degradation and possible livestock health issues.

Prescriptive grazing can be used to manage invasive species. In some instances, carefully targeted grazing (sometimes in combination with other treatments) can reduce or maintain species composition of invasive species. In the Degraded State, grazing may be possible but is generally not economically and/or environmentally sustainable.

## **Hydrological functions**

The hydrologic cycle functions best in the Reference State (1) with good infiltration and deep percolation of rainfall; however, the cycle degrades as the vegetation community declines. Rapid rainfall infiltration, high soil organic matter, good soil structure, and good porosity accompany high bunchgrass canopy cover (Thurow et al. 1986). High ground cover reduces rain drop impact on the soil surface, which keeps erosion very low.

Water leaving the site will have minimal sediment load, which allows for high water quality in associated streams. High rates of infiltration will allow water to move below the rooting zone during periods of heavy rainfall. The Bluebunch Community (1.1) should have no rills or gullies present and drainage ways should be vegetated and stable. Water flow patterns will not be present under the Reference State (1). Plant pedestals are essentially non-existent. Plant litter remains in place and is not moved by wind or water.

Improper grazing management results in a community shift to the Mixed Bunchgrass Community (1.2). This plant community has a similar canopy cover, but bare ground will be less than 15 percent. Therefore, the hydrologic cycle is functioning at a level similar to the water cycle in the Bluebunch Bunchgrass Community (1.1). When compared to the Bluebunch Bunchgrass Community (1.1) the infiltration rates of Mixed Bunchgrass Community (1.2) are slightly reduced and surface runoff is slightly higher though often minimal.

In the Shortgrass-Shrub Community (2.2), Degraded State (3) and the Invaded State (4) canopy and ground cover are greatly reduced compared to the Reference State (1), which impedes the hydrologic cycle. Infiltration will decrease and runoff will increase due to reduced ground cover, presence of shallow-rooted species, rainfall splash, soil capping, reduced organic matter, and weak soil structure. Sparse ground cover and decreased infiltration can combine to increase frequency and severity of flooding within a watershed. Soil erosion is accelerated, quality of surface runoff is poor, and sedimentation increases (McCalla et al. 1984).

Hydrology of the Conifer Encroached State (5) is highly variable however studies suggest that increased tree canopy affects interception of rainfall and well as reduces available soil moisture for herbaceous vegetation. This can negatively affect infiltration and increase runoff (Pierson et al. 2010)(Miller et al. 2000).

## **Recreational uses**

This site provides recreational opportunities for hiking, horseback riding, big game and upland bird hunting. Some forbs have flowers that appeal to photographers. This site provides valuable open space.

## **Wood products**

All stages of the Conifer Encroached State may express some wood products such as firewood, thin post and pole, and/or decorative wood.

## **Other products**

none

## **Inventory data references**

Information presented was derived from NRCS inventory data, literature, field observations, and personal contacts with range-trained personnel (i.e., used professional opinion of agency specialists, observations of land managers, and outside scientists).

## **References**

- Arno, S.F. and G.E. Gruell. 1982. Fire History at the Forest-Grassland Ecotone in Southwestern Montana. *Journal of Range Management* 36:332–336.
- Bestelmeyer, B., J.R. Brown, K.M. Havstad, B. Alexander, G. Chavez, and J.E. Herrick. 2003. Development and Use of State and Transition Models for Rangelands. *Journal of Range Management* 56:114–126.
- Bestelmeyer, B. and J.R. Brown. 2005. State-and-Transition Models 101: a Fresh Look at Vegetation Change.
- Bestelmeyer, B. and J. Brown. 2005. State-and-Transition Models 101: A Fresh look at vegetation change.
- Bestelmeyer, B.T., K. Moseley, P.L. Shaver, H. Sanchez, D.D. Briske, and M.E. Fernandez-Gimenez. 2010. Practical guidance for developing state-and-transition models. *Rangelands* 32:23–30.
- Bestelmeyer, B.T., J.C. Williamson, C.J. Talbot, G.W. Cates, M.C. Duniway, and J.R. Brown. 2016. Improving the Effectiveness of Ecological Site Descriptions: General State-and-Transition Models and the Ecosystem Dynamics Interpretive Tool (EDIT). *Rangelands* 38:329–335.
- Blaisdell, J.P. and R.C. Holmgren. 1984. Managing Intermountain Rangelands--Salt-Desert Shrub Ranges. General Tech Report INT-163. USDA Forest Service, Intermountain Forest and Range Experiment Station, Ogden, UT. 52.
- Braun, C.E., T. Britt, and R.O. Wallestad. 1977. Guidelines for Maintenance of Sage Grouse Habitats. *Wildlife Society Bulletin (1973-2006)* 5:99–106.
- Briske, D.D., B.T. Bestelmeyer, T.K. Stringham, and P.L. Shaver. 2008. Recommendations for Development of Resilience-Based State-and-Transition Models. *Rangeland Ecology & Management* 61:359–367.
- DiTomaso, J.M. 2000. Invasive weeds in Rangelands: Species, Impacts, and Management. *Weed Science* 48:255–265.
- Gruell, G.E. 1983. Fire and vegetative trends in the Northern Rockies: interpretations from 1871-1982 photographs. USDA Forest Service General Technical Report INT-158. U.S. Department of Agriculture, Forest Service, Intermountain Forest and Range Experiment Station, Ogden, UT. 1–117.

- Hayden, F.V. 1873. Sixth Annual Report of the United States Geological Survey of the Territories, embracing portions of Montana, Idaho, Wyoming, and Utah, being a report of progress of the explorations for the year 1872.
- Hobbs, J.R. and S.E. Humphries. 1995. An integrated approach to the ecology and management of plant invasions. *Conservation Biology* 9:761–770.
- Lesica, P. and S.V. Cooper. 1997. Presettlement vegetation of Southern Beaverhead County, MT.
- Lesica, P., S.V. Cooper, and G. Kudray. 2007. Recovery of Big Sagebrush Following Fire in Southwest Montana. *Rangeland Ecology and Management* 60:261–269.
- Masters, R. and R. Sheley. 2001. Principles and practices for managing rangeland invasive plants. *Journal of Range Management* 38:21–26.
- McCalla, G.R., W.H. Blackburn, and L.B. Merrill. 1984. Effects of Livestock Grazing on Infiltration Rates of the Edwards Plateau of Texas. *Journal of Range Management* 37:265–269.
- McLean, A. and S. Wikeem. 1985. Influence of season and intensity of defoliation on bluebunch wheatgrass survival and vigor in southern British Columbia. *Journal of Range Management* 38:21–26.
- Miller, R.F., T.J. Svejcar, and J.A. Rose. 2000. Impacts of western juniper on plant community composition and structure. *Journal of Range Management* 53:574–585.
- Moulton, G.E. and T.W. Dunlay. 1988. *The Journals of the Lewis and Clark Expedition*. Pages in University of Nebraska Press.
- Ross, R.L., E.P. Murray, and J.G. Haigh. July 1973. Soil and Vegetation of Near-pristine sites in Montana.
- Sturm, J.J. 1954. A study of a relict area in Northern Montana. University of Wyoming, Laramie 37.
- Thurow, T.L., W.H. Blackburn, and C.A. Taylor. 1986. Hydrologic Characteristics of Vegetation Types as Affected by Livestock Grazing Systems, Edwards Plateau, Texas. *Journal of Range Management* 39:505–509.
- Wilson, A.M., G.A. Harris, and D.H. Gates. 1966. Cumulative Effects of Clipping on Yield of Bluebunch wheatgrass. *Journal of Range Management* 19:90–91.

## **Contributors**

Grant Peterson

## **Approval**

Kirt Walstad, 3/04/2024

## **Rangeland health reference sheet**

Interpreting Indicators of Rangeland Health is a qualitative assessment protocol used to determine ecosystem condition based on benchmark characteristics described in the Reference Sheet. A suite of 17 (or more) indicators

are typically considered in an assessment. The ecological site(s) representative of an assessment location must be known prior to applying the protocol and must be verified based on soils and climate. Current plant community cannot be used to identify the ecological site.

Author(s)/participant(s)	Grant Petersen
Contact for lead author	grant.petersen@usda.gov 406-683-3804
Date	03/04/2021
Approved by	Kirt Walstad
Approval date	
Composition (Indicators 10 and 12) based on	Annual Production

## Indicators

1. **Number and extent of rills:** Rills will not exist under Reference State.

---

2. **Presence of water flow patterns:** Water flow patterns will not exist under Reference State.

---

3. **Number and height of erosional pedestals or terracettes:** Pedestals and terracettes will not exist under Reference State.

---

4. **Bare ground from Ecological Site Description or other studies (rock, litter, lichen, moss, plant canopy are not bare ground):** Bare ground will be less than 20 percent.

---

5. **Number of gullies and erosion associated with gullies:** Gullies will not be present.

---

6. **Extent of wind scoured, blowouts and/or depositional areas:** Wind scoured, blowouts, and/or depositional areas will not exist on this site under Reference State.

---

7. **Amount of litter movement (describe size and distance expected to travel):** Litter movement is very limited on this site with herbaceous litter moving no more than 4 inches (10 cm) from its origin.

---

8. **Soil surface (top few mm) resistance to erosion (stability values are averages - most sites will show a range of values):** Soils of this site are stable and should have Ratings of 3-6 using the Soil Stability Methods.

---

9. **Soil surface structure and SOM content (include type of structure and A-horizon color and thickness):** Soil Structure at the surface is typically strong to medium fine granular. The A horizon should be 5-7 inches thick with color, when wet, typically ranging in Value of 3 or less and Chroma of 3 or less. Local geology may affect color in which it is important to reference the Official Series Description (OSD) for characteristic range

- 
10. **Effect of community phase composition (relative proportion of different functional groups) and spatial distribution on infiltration and runoff:** Evenly distributed across the site, bunchgrasses improve infiltration while rhizomatous grass protects the surface from runoff forces. The Droughty ecological site is well-drained and has a moderate infiltration rate. An even distribution of mid-statured bunchgrasses with 60 percent of site production, cool-season rhizomatous grasses 6 percent of site production along with a mix of shortgrass (10 percent), forbs (15 percent), shrubs (10 percent), and trees (trace).
- 
11. **Presence and thickness of compaction layer (usually none; describe soil profile features which may be mistaken for compaction on this site):** Not present, some soils profiles may contain an abrupt transition to an argillic horizon which can be interpreted as compaction however the soil structure will typically subangular blocky whereas a compaction layer will tend to be structureless.
- 
12. **Functional/Structural Groups (list in order of descending dominance by above-ground annual-production or live foliar cover using symbols: >>, >, = to indicate much greater than, greater than, and equal to):**
- Dominant: Cool season midstatured bunchgrasses (bluebunch wheatgrass, Columbia needlegrass, green needlegrass, spike fescue)
- Sub-dominant: forbs > cool season shortgrasses = shrubs > rhizomatous grasses >> trees
- Other:
- Additional:
- 
13. **Amount of plant mortality and decadence (include which functional groups are expected to show mortality or decadence):** Mortality in herbaceous species is not evident. Species with bunch growth forms may have some natural mortality in centers.
- 
14. **Average percent litter cover (%) and depth ( in):** Total litter cover ranges from 25 to 35 percent. Most litter is irregularly distributed on the soil surface and is typically 0.25 inches thick
- 
15. **Expected annual annual-production (this is TOTAL above-ground annual-production, not just forage annual-production):** Average production is 1460 pounds per acre (lb/ac) or 1636 kilograms per hectare (kg/ha)  
Low production is 1120 lb/ac or 1255 kg/ha  
High production is 1840 lbs/ac or 2062 kg/ha
- Production values can vary due to site conditions and precipitation. These values represent the Relative Value (RV) ranges for this site...outliers within the Reference State do exist
- 
16. **Potential invasive (including noxious) species (native and non-native). List species which BOTH characterize degraded states and have the potential to become a dominant or co-dominant species on the ecological site if their future establishment and growth is not actively controlled by management interventions. Species that become dominant for only one to several years (e.g., short-term response to drought or wildfire) are not**

**invasive plants. Note that unlike other indicators, we are describing what is NOT expected in the reference state for the ecological site:** dandelion (*Taraxicum* spp), cheatgrass (*Bromus tectorum*), field brome (*Bromus arvensis*), spotted knapweed (*Centaurea stoebe*), yellow toadflax (*Linaria vulgaris*), leafy spurge (*Euphorbia esula*), and Kentucky bluegrass (*Poa pratensis*)

Note: this list may not be fully comprehensive as unknown populations of weeds may exist

Native species with the ability to indicate degradation include the following plants. Species presence alone does not imply degradation. Sandberg bluegrass (*Poa secunda*), big sagebrush (*Artemisia tridentata*), three-tip sagebrush (*Artemisia tripartita*), broom snakeweed (*Gutierrezia sarothrae*), rubber rabbitbrush (*Ericameria nauseosa*), yellow rabbitbrush (*Chrysothamnus viscidiflorus*), Rocky Mountain juniper (*Juniperus scopulorum*), Douglas fir (*Pseudotsuga menziesii*), ponderosa pine (*Pinus ponderosa*)

- 
17. **Perennial plant reproductive capability:** In the reference condition, all plants are vigorous enough for reproduction either by seed or rhizomes in order to balance natural mortality with species recruitment. Density of plants indicates that plants reproduce at levels sufficient to fill available resource.
-