

Ecological site EX043B23B158 Shallow Clayey (SwCy) Absaroka Upper Foothills

Last updated: 10/04/2019
Accessed: 05/01/2024

General information

Provisional. A provisional ecological site description has undergone quality control and quality assurance review. It contains a working state and transition model and enough information to identify the ecological site.

MLRA notes

Major Land Resource Area (MLRA): 043B–Central Rocky Mountains

Major Land Resource Unit (MLRA) 43B: Central Rocky Mountains

43B – Central Rocky Mountains – The Central Rocky Mountains extends from northern Montana to southern extent of Wyoming and from Idaho to central Wyoming. The southern extent of 43B is comprised of a combination of metamorphic, igneous, and sedimentary mountains and foothills. Climatic changes across this extent are broad and create several unique breaks in the landscape.

Further information regarding MLRAs, refer to: United States Department of Agriculture, Natural Resources Conservation Service. 2006. Land Resource Regions and Major Land Resource Areas of the United States, the Caribbean, and the Pacific Basin. U.S. Department of Agriculture Handbook 296.
Available electronically at: http://www.nrcs.usda.gov/wps/portal/nrcs/detail/soils/ref/?cid=nrcs142p2_053624#handbook.

LRU notes

Land Resource Unit (LRU) 43B23B: Absaroka Upper Foothills

Based on the shifts in geology, precipitation patterns and other climatic factors, as well as elevations and vegetation, the Absaroka Range was divided into LRU 23. Further division of this LRU is necessary due to the gradient moving from the foothills to the summit, as well as aspect shifts (north/east face versus south/west face). Subset B is set for the higher elevations within the foothills, with 15 to 19 inches of precipitation. To verify or identify Subset B (the referenced subset for this ecological site), refer to the Wyoming LRU matrix key contained within the Ecological Site Key.

This particular LRU/Subset occurs along the eastern foothills of the Absaroka Range. This LRU starts north of Clark, WY and runs to the Thermopolis, WY area. Once the foothills cross into the Northern Beartooth Range, the climatic patterns and elevational changes shifts the plant community and allows for a break in LRU's near the Montana state line. As the LRU follows to the south and then tracks east to the intersection of the Absaroka Range and the Owl Creek Range, the face changes aspect and geology creating a shift in plant dynamics and a break in the LRU.

The extent of soils currently correlated to this ecological site does not fit within the digitized boundary. Many of the noted soils are provisional and will be reviewed and corrected in mapping update projects. Other map units are correlated as small inclusions within other MLRA's/LRU's based on elevation, landform, and biological references.

Moisture Regime: Typic Ustic

Temperature Regime: Frigid

Dominant Cover: Rangeland – Sagebrush Steppe (major species is Mountain Big Sagebrush)

Representative Value (RV) Effective Precipitation: 15-19 inches (381 – 483 mm)

RV Frost-Free Days: 37 - 80 days

Classification relationships

Relationship to Other Established Classification Systems:

National Vegetation Classification System (NVC):

2 Shrub & Herb Vegetation Class

2.B Temperate & Boreal Grassland & Shrubland Subclass

2.B.2 Temperate Grassland & Shrubland Formation

2.B.2.Na Western North American Grassland & Shrubland Division Division

M048 Central Rocky Mountain Montane-Foothill Grassland & Shrubland Macrogroup

G273 Central Rocky Mountain Lower Montane, Foothill & Valley Grassland Group

Ecoregions (EPA):

Level I: 10 North American Deserts Level II: 10.1 Cold Deserts

Level III: 10.1.18 Wyoming Basin

Level IV: 10.1.18.b Big Horn Basin and

10.1.18.d Foothills and Low Mountains

Ecological site concept

- Site receives no additional water.
- Slope is < 50%
- Soils are:
 - o Textures range from loam to clay in top 4" (10 cm) of mineral soil surface
 - o Clay content is < 40% in top 4" (10 cm) of mineral soil surface
 - o All subsurface horizons have a weighted average of > 35% but < 60% clay.
 - o Shallow (10-20 in. (25-50 cm)
 - o < 10% stone and boulder cover and <25% cobble and gravel cover
 - o Not skeletal (<35% rock fragments) within 20" (50 cm) of mineral soil surface
 - o Non-saline, sodic, or saline-sodic; however, there is a potential for elevated soluble salts.

Associated sites

R043BY304WY	Clayey (Cy) 15-19" Foothills and Mountains East Precipitation Zone Clayey
R043BY362WY	Shallow Loamy (SwLy) 15-19" Foothills and Mountains East Precipitation Zone Shallow Loamy
R043BY376WY	Very Shallow (VS) 15-19" Foothills and Mountains East Precipitation Zone Very Shallow

Similar sites

R032XY358WY	Shallow Clayey (SwCy) 10-14" East Precipitation Zone Shallow Clayey 10-14" Foothills and Basins East P.Z., 032XY358WY has lower production.
-------------	-------------------------------------------------------------------------------------------------------------------------------------------------------

Table 1. Dominant plant species

Tree	Not specified
Shrub	(1) <i>Artemisia tridentata ssp. vaseyana</i>
Herbaceous	(1) <i>Festuca idahoensis</i> (2) <i>Achnatherum nelsonii</i>

Legacy ID

Physiographic features

This site occurs on most slopes and along ridge tops.

Table 2. Representative physiographic features

Landforms	(1) Foothills > Hill (2) Foothills > Alluvial fan (3) Foothills > Ridge (4) Foothills > Stream terrace
Runoff class	Negligible to very high
Elevation	1,829–2,743 m
Slope	20–50%
Aspect	Aspect is not a significant factor

Climatic features

Annual precipitation and modeled relative effective annual precipitation ranges from 15 to 19 inches (381 – 483 mm). The normal precipitation pattern shows peaks in June tapering into September. This amounts to about 50% of the mean annual precipitation. Average snowfall is about 150 inches annually. Wide fluctuations may occur in yearly precipitation and result in more dry years than those with more than normal precipitation.

Because of the varied topography, the wind will vary considerably for different parts of the area. The wind is usually much lighter at the lower elevations and in the valleys as compared with the higher terrain. The average winter wind velocity is 8.5 mph while the summer wind velocity averages 7.5 mph. Winds during storms and on ridges may exceed 45 mph.

Temperatures show a wide range between summer and winter and between daily maximums and minimums, due to the high elevation and dry air, which permits rapid incoming and outgoing radiation. Cold air outbreaks from Canada in winter move rapidly from northwest to southeast and account for extreme minimum temperatures. Chinook winds may occur in winter and bring rapid rises in temperature. High winds are generally blocked by high mountains but occur in conjunction with thunderstorms, which are common in late summer. Growth of native cool-season plants begins about May 1 to May 15 and continues until about October 15.

For detailed information visit the Natural Resources Conservation Service National Water and Climate Center at <http://www.wcc.nrcs.usda.gov/>. Historically, "Crandall Creek" was the representative weather stations within this subset. However, "Sunshine 3NE" is the only available weather station within a close proximity in location and characteristics for this subset. The following graphs and charts are a collective sample representing the averaged normals and 30-year annual rainfall data for the selected weather stations from 1981 to 2010.

Table 3. Representative climatic features

Frost-free period (characteristic range)	40 days
Freeze-free period (characteristic range)	84 days
Precipitation total (characteristic range)	356 mm
Frost-free period (actual range)	40 days
Freeze-free period (actual range)	84 days
Precipitation total (actual range)	356 mm
Frost-free period (average)	40 days
Freeze-free period (average)	84 days
Precipitation total (average)	356 mm

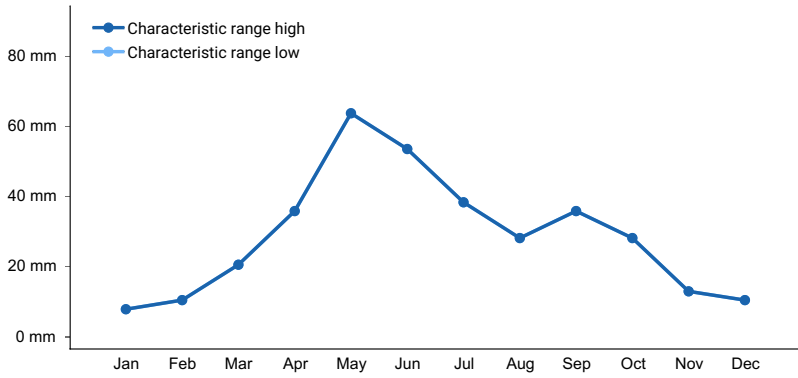

Figure 1. Monthly precipitation range

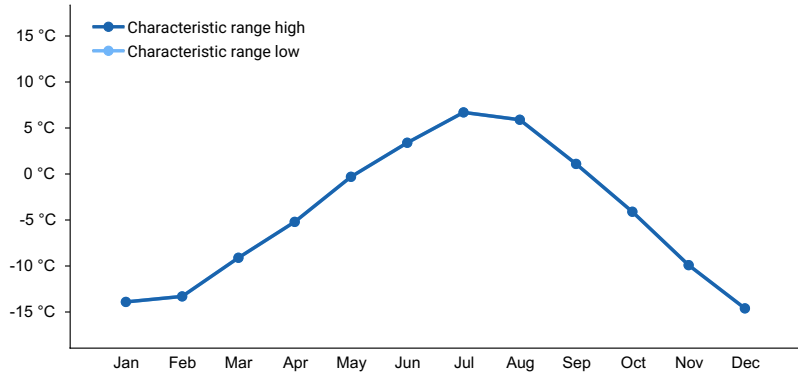

Figure 2. Monthly minimum temperature range

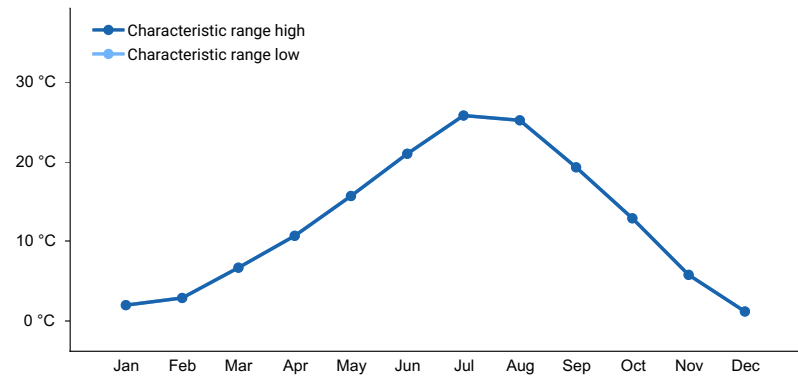

Figure 3. Monthly maximum temperature range

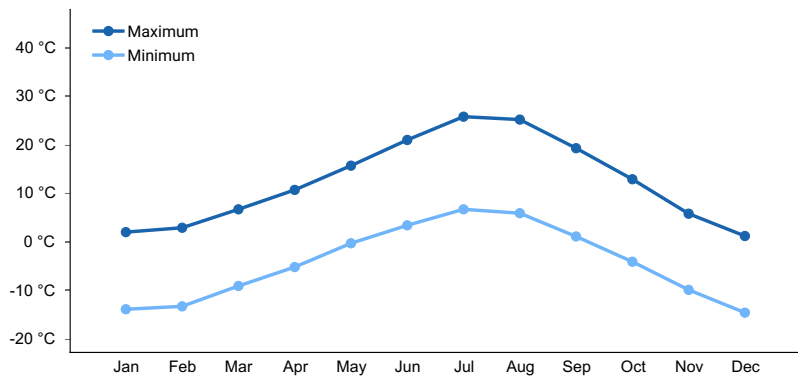

Figure 4. Monthly average minimum and maximum temperature

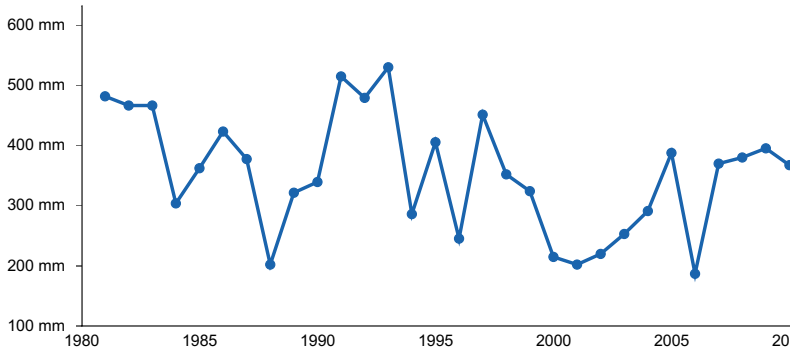

Figure 5. Annual precipitation pattern

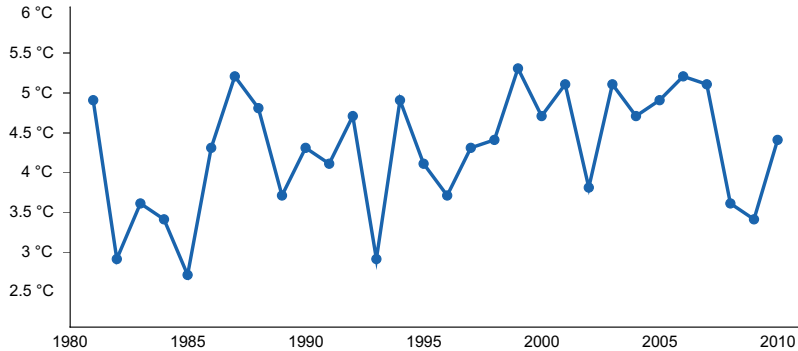

Figure 6. Annual average temperature pattern

Climate stations used

- (1) SUNSHINE 3NE [USC00488758], Meeteetse, WY

Influencing water features

The characteristics of these upland soils have no influence from ground water (water table below 60 inches (150 cm)) and have minimal influence from surface water/overland flow. There may be isolated features that are affected by snow pack that persists longer than surrounding areas due to position on the landform (shaded/protected pockets).

Soil features

The soils of this site are shallow (less than 20" to bedrock) well drained, and moderately to slowly permeable. The bedrock is typically shale and is virtually impermeable to plant roots. The soil characteristics having the most influence on the plant community are the shallow depths, heavy textures, and the potential for elevated quantities of soluble salts.

Table 4. Representative soil features

Parent material	(1) Alluvium–shale (2) Residuum
Surface texture	(1) Clay loam (2) Silty clay loam (3) Clay (4) Silty clay
Family particle size	(1) Clayey
Drainage class	Well drained
Permeability class	Very slow to moderately slow
Depth to restrictive layer	25–51 cm

Soil depth	25–51 cm
Surface fragment cover <=3"	0–25%
Available water capacity (0-101.6cm)	3.56–10.67 cm
Calcium carbonate equivalent (0-101.6cm)	0–10%
Electrical conductivity (0-101.6cm)	0–4 mmhos/cm
Sodium adsorption ratio (0-101.6cm)	0–5
Soil reaction (1:1 water) (0-101.6cm)	6.1–8.4
Subsurface fragment volume <=3" (Depth not specified)	5–15%

Ecological dynamics

Potential vegetation on this site is dominated by mid cool-season perennial grasses. Other significant vegetation includes big and black sagebrush and a variety of forbs. The expected potential composition for this site is about 75% grasses, 15% forbs and 10% woody plants. The composition and production will vary naturally due to historical use, fluctuating precipitation and fire frequency.

As this site deteriorates species such as rhizomatous wheatgrasses, bluegrasses and big sagebrush will increase. Cool season grasses such as Idaho fescue, Columbia needlegrass, and bluebunch wheatgrass will decrease in frequency and production. As the site continues to deteriorate, annual forbs and grasses such as cheatgrass and will invade.

Big sagebrush may become dominant on areas with an absence of fire and sufficient amount of precipitation. Wildfires are actively controlled in recent times and as a result old decadent stands of big sagebrush persist. Chemical and mechanical controls have replaced the historic role of fire on this site. Recently, prescribed burning has regained some popularity.

The big sagebrush component may not be as resilient once it has been removed or severely reduced, if a vigorous stand of grass exists and is maintained. The exception to this is where the herbaceous component is severely degraded at the time of treatment, growing conditions are unfavorable after treatment, and/or recovery of herbaceous species are inadequate due to poor grazing management. Regeneration of big sagebrush may also be suppressed if three-tip sagebrush and rubber rabbitbrush become established. This situation is more likely to develop in areas where fires have occurred in a relatively short cycle. Three-tip sagebrush and rubber rabbitbrush are strong resprouters and will out compete other shrubs where a site is disturbed. Any thinning project should be designed in a way to maintain the viability of the stand and to consider wildlife requirements.

The Historic Climax Plant Community (description follows the plant community diagram) has been determined by study of rangeland relic areas, or areas protected from excessive disturbance. Trends in plant communities going from heavily grazed areas to lightly grazed areas, seasonal use pastures, and historical accounts have also been used.

The following is a State and Transition Model Diagram that illustrates the common plant communities (states) that can occur on the site and the transitions between these communities. The ecological processes will be discussed in more detail in the plant community narratives following the diagram.

State and transition model

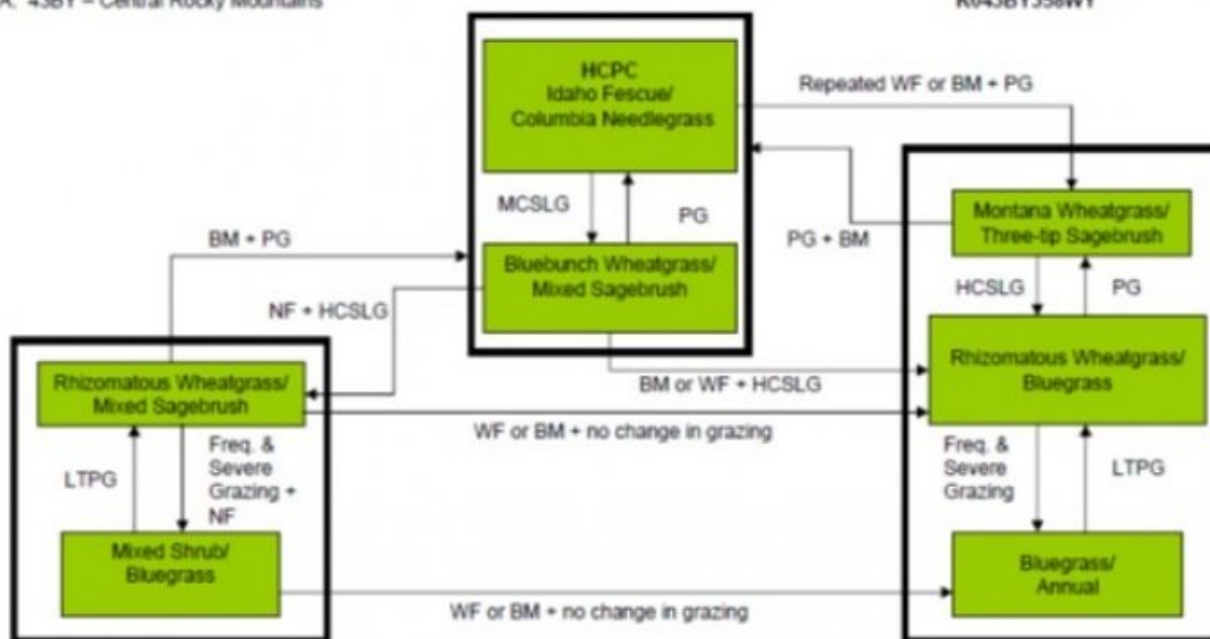

BM – Brush Management (fire, chemical, mechanical)
 Freq. & Severe Grazing – Frequent and Severe Utilization of the Cool-season Mid-grasses during the Growing Season
 GLMT – Grazing Land Mechanical Treatment
 LTPG – Long-term Prescribed Grazing
 MCSLG – Moderate, Continuous Season-long Grazing
 HCSLG – Heavy, Continuous Season-long Grazing
 NU, NF – No Use and No Fire
 PG – Prescribed Grazing (proper stocking rates with adequate recovery periods during the growing season)
 VLTPG – Very Long-term Prescribed Grazing (could possibly take generations)
 Na – Moderate Sodium in Soil
 WF – Wildfire

State 1 Idaho Fescue/Columbia Needlegrass Plant Community

Community 1.1 Idaho Fescue/Columbia Needlegrass Plant Community

The interpretive plant community for this site is the Historic Climax Plant Community. This state evolved with grazing by large herbivores, soil less than 20 inches, and an occasional wildfire. The cyclical nature of the fire regime in this community prevents big sagebrush from being the dominant landscape. Potential vegetation is about 75% grasses or grass-like plants, 15% forbs, and 10% woody plants. The state is comprised of mostly cool season mid-grasses and a variety of forbs and woody species. The major grasses include Idaho fescue, Columbia needlegrass, spikefescue, and bluebunch and rhizomatous wheatgrasses. Big and black sagebrush are conspicuous elements of this state. A variety of forbs also occurs in this state and plant diversity is high (see Plant Composition Table). This state produces between 500 and 1000 pounds annually, depending on the growing conditions. This plant community is extremely stable and well adapted to the Central Rocky Mountains climatic conditions. The diversity in plant species allows for high drought tolerance. This is a sustainable plant community (site/soil stability, watershed function, and biologic integrity). Transitions or pathways leading to other plant communities are as follows:

- Moderate, continuous season-long grazing will convert the plant community to the Bluebunch Wheatgrass/Big Sagebrush Plant Community.
- Repeated Wild Fire or Brush Management plus Prescribed Grazing will convert the HCPC to the Montana Wheatgrass/Three-tip Sagebrush/ Plant Community.

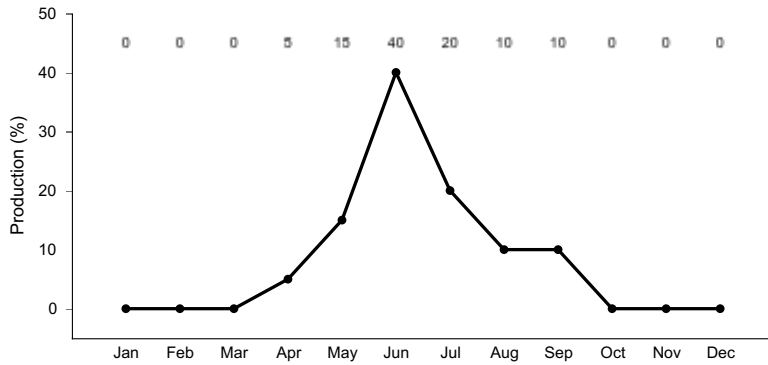

Figure 8. Plant community growth curve (percent production by month). WY0601, 15-19E all upland sites.

State 2

Bluebunch Wheatgrass/Mixed Sagebrush Plant Community

Community 2.1

Bluebunch Wheatgrass/Mixed Sagebrush Plant Community

Historically, this plant community evolved under grazing by large ungulates and a low fire frequency. Currently, this site is normally found under moderate, season-long grazing regime and will be exacerbated by prolonged drought conditions. In addition, the fire regime for this site has been modified and extended periods without fire is now common. Big and black sagebrushes are important components of this plant community. Cool-season grasses make up the majority of the understory with the balance made up of miscellaneous forbs. Dominant grasses include Idaho fescue, rhizomatous wheatgrass, bluebunch wheatgrass and of less frequency Columbia needlegrass and spikefescue. Grasses of secondary importance include prairie junegrass, slender wheatgrass, bluegrasses, and spike trisetum. Forbs commonly found in this plant community include asters, phlox, buckwheat, pussytoes, lupine, paintbrush, and larkspurs. Sagebrush comprises from 15% to 20% of the total annual production. When compared to the Historical Climax Plant Community, big and black sagebrushes, rhizomatous wheatgrasses, and bluegrasses have increased. Columbia needlegrass and spikefescue have decreased, often occurring only where protected from grazing by the sagebrush canopy. Some weedy species such as cheatgrass may have invaded the site but are in small patches. This state produces between 450 and 950 pounds annually, depending on the growing conditions. This plant community is resistant to change. The herbaceous species present are well adapted to grazing; however, species composition can be altered through long-term overgrazing. The herbaceous component is mostly intact and plant vigor and replacement capabilities are sufficient. Water flow patterns and litter movement may be occurring but only on steeper slopes. Incidence of pedestalling is minimal. Soils are mostly stable and the surface shows minimum soil loss. The watershed is functioning and the biotic community is intact. Transitions or pathways leading to other plant communities are as follows:

- Prescribed grazing will convert this plant community to the HCPC. The probability of this occurring is high especially if rotational grazing along with short deferred grazing is implemented as part of the prescribed method of use. In addition, the removal of fire suppression will allow a somewhat natural fire regime to reoccur to more easily transition between this plant community and the HCPC. A prescribed fire treatment can be useful to hasten this transition if desired.
- Heavy, continuous, season-long grazing plus no fires will convert the plant community to the Rhizomatous Wheatgrass/Mixed Sagebrush Plant Community. The probability of this occurring is high. This is especially evident on areas where drought or heavy browsing does not adversely impact the shrub stand.
- Heavy, continuous, season-long grazing plus wildfire or brush management, will convert the plant community to a Rhizomatous Wheatgrass/Bluegrass Plant Community. The probabilities for this is high especially on areas were the shrubs have been heavily browsed or removed by natural or human causes. Drought can also exacerbate this transition.

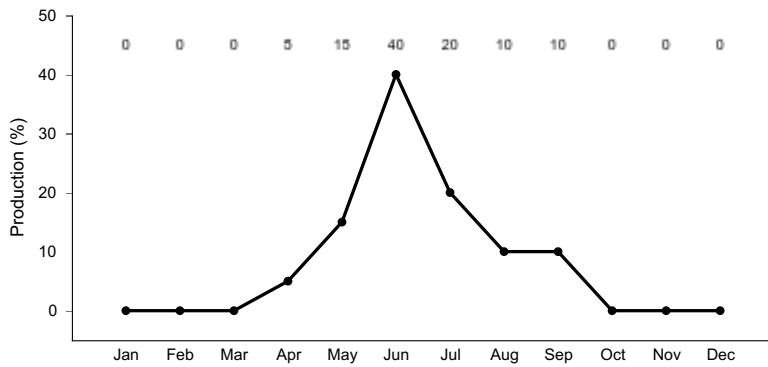

Figure 9. Plant community growth curve (percent production by month). WY0601, 15-19E all upland sites.

State 3

Rhizomatous Wheatgrass/Mixed Sagebrush Plant Community

Community 3.1

Rhizomatous Wheatgrass/Mixed Sagebrush Plant Community

This plant community currently is found under heavy continuous season-long grazing by livestock and protection from fire. Shrubs are a significant component of this plant community. Cool-season grasses make up the majority of the understory, but some of the preferred grasses have been reduced or are absent. Dominant grasses include rhizomatous wheatgrass, Lettermans needlegrass, prairie junegrass, bluegrasses and of less frequency Columbia needlegrass, spikefescue, Idaho fescue and bluebunch wheatgrass. Grasses of secondary importance include slender wheatgrass, spike trisetum, Indian ricegrass, mountain muhly, bottlebrush squirreltail, and native bromes. Forbs commonly found in this plant community include biscuitroot, wild onion, buckwheat, leafy wildparsley, phlox, lupine, larkspur, asters, pussytoes, and American vetch. Black and big sagebrushes and green rabbitbrush can make up to 30% of the total annual production. When compared to the Historic Climax Plant Community, black and big sagebrush, green rabbitbrush, bluegrasses, prairie junegrass, and rhizomatous wheatgrasses have increased. Most of the preferred grasses have been reduced and some are absent. Some annuals, such as cheatgrass, have invaded the site, but are not yet abundant. Annual production ranges from 400 to 800 pounds. This plant community is resistant to change as the shrubs become more abundant. These areas may actually be more resistant to fire as less fine fuels are available and the bare ground between the shrubs is increased. The herbaceous component is not as diverse and plant vigor and species regeneration capabilities of some cool-season perennials are deficient. The removal of grazing does not seem to affect the plant composition or structure of the plant community. Soil erosion is accelerated because of increased bare ground. Water flow patterns and pedestalling is more noticeable. Infiltration is reduced and runoff is increased. Rill channels may be noticeable in the interspaces on steeper areas and gullies may be establishing where rills have concentrated down slope. Transitions or pathways leading to other plant communities are as follows:

- Prescribed grazing plus brush management will convert this plant community to near HCPC. If prescribed fire is used as a means to reduce or remove the shrubs, sufficient fine fuels will need to be present. This may require deferment from grazing prior to treatment. Post management is critical to ensure success. This can range from two or more years of rest to partial growing season deferment, depending on the condition of the understory at the time of treatment and the growing conditions following treatment. Seeding will be required regardless of the brush treatment to reestablish the major cool-season grasses.
- Frequent and Severe grazing plus no fires will convert the plant community to the Mixed Shrub/Bluegrass Plant Community. The probability of this occurring is high and is especially evident on areas where drought or heavy browsing does not adversely impact the shrub stand.
- Brush management or Wildfire with no change in grazing management will convert this plant community to the Rhizomatous Wheatgrass/Bluegrass Plant Community.

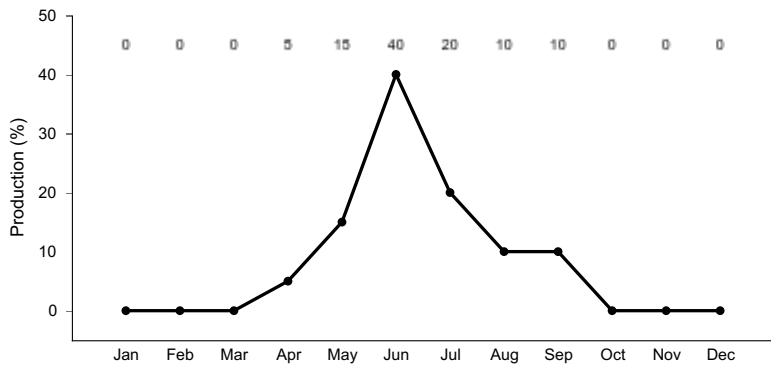

Figure 10. Plant community growth curve (percent production by month). WY0601, 15-19E all upland sites.

State 4 Mixed Shrub/Bluegrass Plant Community

Community 4.1 Mixed Shrub/Bluegrass Plant Community

This plant community is the result of frequent and severe grazing and protection from fire. Shrubs are a dominant component of this plant community and annual production can exceed 30%. Big and black sagebrushes, green rabbitbrush, and bluegrasses comprise the primary components of the plant community as the preferred cool season grasses have been eliminated or greatly reduced. The interspaces between plants have expanded leaving the amount of bare ground more prevalent and more soil surface exposed to erosive elements. The dominant grasses are the bluegrasses such as Sandberg, mutton, big, and Canby. Weedy annual species such as cheatgrass, kochia, Russian thistle, and a variety of mustards may occupy the site. Noxious weeds such as Canada thistle may invade the site if a seed source is available. The interspaces between plants have expanded leaving the amount of bare ground more prevalent. When compared with the HCPC, the annual production is less, as the major cool-season grasses are reduced, but the shrub production has increased significantly and compensates for some of the decline in the herbaceous production. Annual production ranges from 300 to 700 pounds. This plant community is resistant to change as the stand becomes more decadent. These areas may actually be more resistant to fire as less fine fuels are available and the bare ground between the shrubs is increased. The herbaceous component is not as diverse and plant vigor and species regeneration capabilities of cool-season perennials are deficient. The removal of grazing does not seem to affect the plant composition or structure of the plant community. Soil erosion is accelerated because of increased bare ground. Water flow patterns and pedestalling are obvious. Infiltration is reduced and runoff is increased. Rill channels may be noticeable in the interspaces and gullies may be establishing where rills have concentrated down slope. Transitions or pathways leading to other plant communities are as follows: • Long-term prescribed grazing will convert this plant community to the Rhizomatous Wheatgrass/Mixed Sagebrush Plant Community. • Brush management or Wildfire with no change in grazing management will convert this plant community to the Bluegrass/Annual Plant Community.

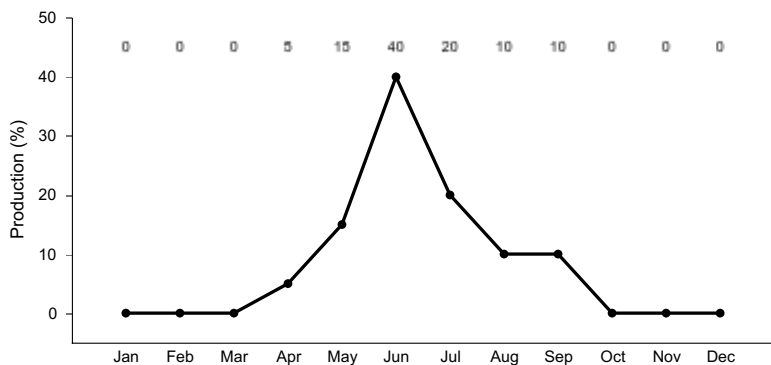

Figure 11. Plant community growth curve (percent production by month). WY0601, 15-19E all upland sites.

State 5 Montana Wheatgrass/Three-tip Sagebrush Plant Community

Community 5.1

Montana Wheatgrass/Three-tip Sagebrush Plant Community

This plant community currently is found under prescribed grazing and is perpetuated by a fire cycle, which maintains the removal of big sagebrush. Three-tip sagebrush and Montana wheatgrass are significant components of this plant community. Cool-season grasses remain an important component, but some bunchgrasses are not as abundant. Dominant grasses include Montana wheatgrass, prairie junegrass, and rhizomatous wheatgrasses, and of less frequency Columbia needlegrass, Idaho fescue, bluebunch wheatgrass, and spikefescue. Grasses of secondary importance include one-spike oatgrass, slender wheatgrass, spike trisetum, and bluegrasses. Forbs commonly found in this plant community include biscuitroot, wild onion, buckwheat, leafy wildparsley, phlox, lupine, larkspur, asters, pussytoes, and American vetch. Three-tip sagebrush as well as pockets of black sagebrush can comprise as much as 25% of the total production. When compared to the Historical Climax Plant Community, Montana wheatgrass, and rhizomatous wheatgrass have increased. Columbia needlegrass, bluebunch wheatgrass, spikefescue, and Idaho fescue have decreased. Production of cool-season grasses has remained about the same. Cheatgrass can be common and in large patches, but most of the invaded areas are relatively small. Annual production ranges from 450 to 900 pounds. This plant community is resistant to change. The herbaceous species present are well adapted to grazing; however, species composition can be altered through long-term overgrazing. The herbaceous component is mostly intact and plant vigor and replacement capabilities are sufficient. Water flow patterns and litter movement may be occurring but only on steeper slopes. Incidence of pedestalling is minimal. Soils are mostly stable and the surface shows minimum soil loss. The watershed is functioning and the biotic community is intact. Transitions or pathways leading to other plant communities are as follows: • Prescribed grazing and brush management will convert this plant community to the HCPC. Controlling three-tip sagebrush is difficult as it is a strong resprouter. Reestablishing the big and black sagebrush stand may be difficult and may take many years. • Heavy, continuous, season-long grazing will convert this plant community to a Rhizomatous Wheatgrass/Bluegrass Plant community. More than likely, three-tip sage will persist in varying degrees as it is difficult to control and is a strong resprouter.

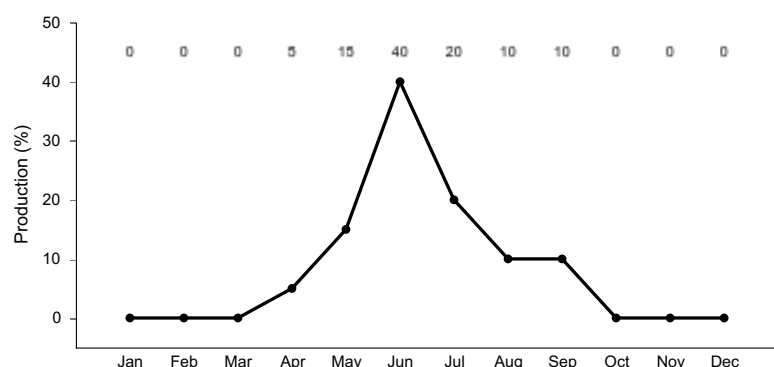

Figure 12. Plant community growth curve (percent production by month). WY0601, 15-19E all upland sites.

State 6

Rhizomatous Wheatgrass/Bluegrass Plant Community

Community 6.1

Rhizomatous Wheatgrass/Bluegrass Plant Community

This plant community currently is found under heavy continuous season-long grazing by livestock and is perpetuated by either brush management or wildfire, which removes big sagebrush from the plant community. Three-tip sagebrush can be a significant component of this plant community, but also may be lacking. Some of the major cool-season bunchgrasses associated with this ecological site have been reduced and some may have been removed. Dominant grasses include rhizomatous wheatgrasses, bluegrasses, prairie junegrass, spike trisetum, and Montana wheatgrass, and of less frequency Columbia needlegrass, Idaho fescue, bluebunch wheatgrass, and spikefescue. Forbs commonly found in this plant community include phlox, groundsel, biscuitroot, locoweed, larkspur, lupine, pussytoes, miner's candle, hawksbeard, and milkvetch. Three-tip sagebrush as well as pockets of black sagebrush can comprise as much as 25% of the total production. When compared to the Historical Climax Plant Community, rhizomatous wheatgrass, prairie junegrass, and Montana wheatgrass have increased. Columbia needlegrass, bluebunch wheatgrass, Idaho fescue, and big sagebrush have decreased or have been removed.

Production of the preferred cool-season grasses has been reduced. Cheatgrass can be common and in large patches, but mostly invaded areas are relatively small. Annual production ranges from 350 to 750 pounds. This plant community is resistant to change. However, species composition can be altered through long-term overgrazing. The herbaceous component is mostly intact, but some cool-season bunchgrasses associated with the site have been reduced or removed. Plant vigor and replacement capabilities are sufficient for some species but not all. Water flow patterns and litter movement is occurring but only on steeper slopes. Incidence of pedestalling is moderate to slight. Soils are mostly stable and the surface shows minimum soil loss. The watershed is functioning and the biotic community is partially intact. Transitions or pathways leading to other plant communities are as follows: • Prescribed grazing will convert this plant community to the Montana Wheatgrass/Three-tip Sagebrush Plant community. • Frequent and Severe Grazing will convert this plant community to a Bluegrass/Annual Plant Community. If three-tip sage is present more than likely it will persist in varying degrees as it is difficult to control.

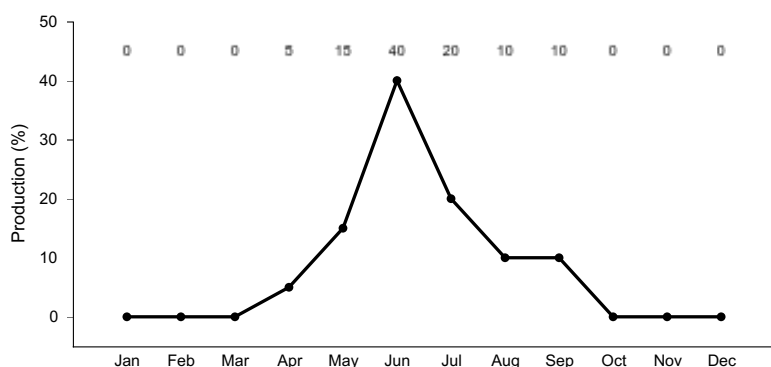

Figure 13. Plant community growth curve (percent production by month). WY0601, 15-19E all upland sites.

State 7

Bluegrass/Annual Plant Community

Community 7.1

Bluegrass/Annual Plant Community

This plant community evolved under frequent and severe heavy grazing and the big sagebrush shrub component has been removed by heavy browsing, wildfire or human means. Weedy annuals and bluegrasses are the most dominant plants and occupy any open bare ground areas. Three-tip sagebrush may or may not be present on this site. However, it is common for this shrub to occur as it is a strong resprouter and may quickly establish site after a disturbance. Compared to the HCPC, weedy annual species and bluegrasses are widespread and virtually all of the major cool-season mid-grasses are absent or severely decreased. Big sagebrush has also been removed. Weedy annuals may include cheatgrass, kochia, Russian thistle, and a variety of mustards. Bluegrass species will include Sandberg, mutton, Canby, and big. Noxious weeds such as Canada thistle may invade the site if a seed source is available. The interspaces between plants have expanded leaving the amount of bare ground more prevalent and more soil surface exposed to erosive elements. Annual production ranges from 200 to 500 pounds. This plant community is relatively stable and resistant to overgrazing. Annuals and bluegrasses are effectively competing against the establishment of perennial cool-season grasses. Plant diversity is greatly altered and the herbaceous component is not intact. Recruitment of the major perennial grasses is not occurring and the replacement potential is absent. The biotic integrity is missing. The soils are unstable and not protected from excessive erosion. Rill channels and maybe even gullies may be present on site and adjacent areas are impacted by excessive runoff. Water flow patterns and pedestalling are obvious. The watershed is not functioning. Transitions or pathways leading to other plant communities are as follows: • Long Term Prescribed Grazing may eventually convert this plant community to the Rhizomatous Wheatgrass/Bluegrass Plant community.

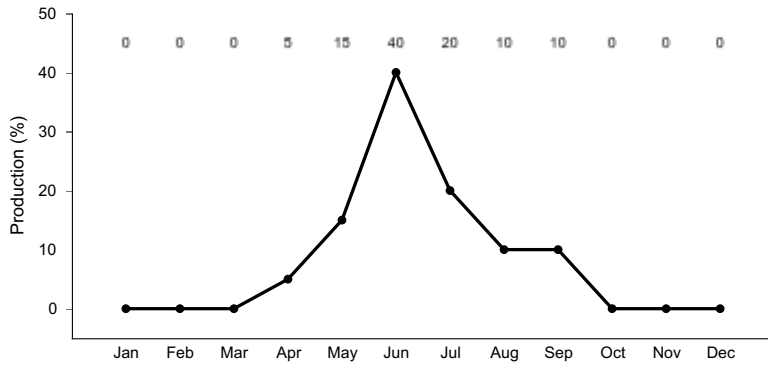

Figure 14. Plant community growth curve (percent production by month). WY0601, 15-19E all upland sites.

Additional community tables

Table 5. Community 1.1 plant community composition

Group	Common Name	Symbol	Scientific Name	Annual Production (Kg/Hectare)	Foliar Cover (%)
Grass/Grasslike					
1				95–191	
	Idaho fescue	FEID	<i>Festuca idahoensis</i>	95–191	–
2				48–143	
	Columbia needlegrass	ACNE9	<i>Achnatherum nelsonii</i>	48–143	–
3				48–143	
	bluebunch wheatgrass	PSSP6	<i>Pseudoroegneria spicata</i>	48–143	–
4				48–143	
	western wheatgrass	PASM	<i>Pascopyrum smithii</i>	48–143	–
5				0–95	
	spike fescue	LEK12	<i>Leucopoa kingii</i>	0–95	–
6				95–191	
	Grass, perennial	2GP	<i>Grass, perennial</i>	0–48	–
	Indian ricegrass	ACHY	<i>Achnatherum hymenoides</i>	0–48	–
	Letterman's needlegrass	ACLE9	<i>Achnatherum lettermanii</i>	0–48	–
	nodding brome	BRAN	<i>Bromus anomalus</i>	0–48	–
	Pumpelly's brome	BRINP5	<i>Bromus inermis ssp. pumpellianus var. pumpellianus</i>	0–48	–
	mountain brome	BRMA4	<i>Bromus marginatus</i>	0–48	–
	Montana wheatgrass	ELAL7	<i>Elymus albicans</i>	0–48	–
	squirreltail	ELEL5	<i>Elymus elymoides</i>	0–48	–
	slender wheatgrass	ELTR7	<i>Elymus trachycaulus</i>	0–48	–
	mountain muhly	MUMO	<i>Muhlenbergia montana</i>	0–48	–
	Sandberg bluegrass	POSE	<i>Poa secunda</i>	0–48	–
	spike trisetum	TRSP2	<i>Trisetum spicatum</i>	0–48	–
Forb					
7				0–143	
	Forb, perennial	2FP	<i>Forb, perennial</i>	0–48	–

	yarrow	ACHIL	<i>Achillea</i>	0–48	–
	textile onion	ALTE	<i>Allium textile</i>	0–48	–
	rosy pussytoes	ANRO2	<i>Antennaria rosea</i>	0–48	–
	Indian paintbrush	CASTI2	<i>Castilleja</i>	0–48	–
	field chickweed	CEAR4	<i>Cerastium arvense</i>	0–48	–
	larkspur	DELPH	<i>Delphinium</i>	0–48	–
	sulphur-flower buckwheat	ERUM	<i>Eriogonum umbellatum</i>	0–48	–
	aster	EUCEP2	<i>Eucephalus</i>	0–48	–
	cous biscuitroot	LOCO4	<i>Lomatium cous</i>	0–48	–
	lupine	LUPIN	<i>Lupinus</i>	0–48	–
	leafy wildparsley	MUDI	<i>Musineon divaricatum</i>	0–48	–
	beardtongue	PENST	<i>Penstemon</i>	0–48	–
	phlox	PHLOX	<i>Phlox</i>	0–48	–
Shrub/Vine					
8				48–95	
	big sagebrush	ARTR2	<i>Artemisia tridentata</i>	48–95	–
9				0–48	
	black sagebrush	ARNO4	<i>Artemisia nova</i>	0–48	–
10				0–48	
	yellow rabbitbrush	CHVI8	<i>Chrysothamnus viscidiflorus</i>	0–48	–
11				0–48	
	Shrub (>.5m)	2SHRUB	<i>Shrub (>.5m)</i>	0–48	–

Animal community

Animal Community – Wildlife Interpretations

Idaho Fescue/Columbia Needlegrass Plant Community (HCPC): The predominance of grasses in this plant community favors grazers and mixed-feeders, such as deer, bison, elk, and antelope. Suitable thermal and escape cover for deer may be limited due to the low quantities of woody plants. However, topographical variations could provide some escape cover. Due to the location of these sites on the foot slopes of mountains they are valuable for elk and deer winter ranges. When found adjacent to sagebrush dominated states, this plant community may provide brood rearing/foraging areas for sage grouse, as well as lek sites. Other birds that would frequent this plant community include western meadowlark, lark bunting, sage thrasher, horned larks, red-tail and ferruginous hawks, and golden eagles. Many grassland obligate small mammals would occur here.

Bluebunch Wheatgrass/Mixed Sagebrush Plant Community: The combination of an overstory of big sagebrush and an understory of grasses and forbs provides a very diverse plant community for wildlife. The crowns of sagebrush tend to break up hard crusted snow on winter ranges, so mule deer, elk, and antelope may use this state for foraging and cover year-round, as would cottontail and jack rabbits. It provides important winter, nesting, brood-rearing, and foraging habitat for sage grouse. Brewer's sparrows' nest in big sagebrush plants and hosts of other nesting birds utilize stands in the 20-30% cover range. Other birds that would frequent this plant community include western meadowlark, lark bunting, sage thrasher, horned larks, red-tail and ferruginous hawks, and golden eagles.

Rhizomatous Wheatgrass/Mixed Sagebrush Plant Community: The combination of an overstory of big sagebrush and an understory of grasses and forbs provides a very diverse plant community for wildlife. The crowns of sagebrush tend to break up hard crusted snow on winter ranges, so mule deer, elk, and antelope may use this state for foraging and cover year-round, as would cottontail and jack rabbits. It provides important winter, nesting, brood-rearing, and foraging habitat for sage grouse. Brewer's sparrows' nest in big sagebrush plants and hosts of other nesting birds utilize stands in the 20-30% cover range.

Mixed Shrub/Bluegrass Plant Community: This plant community can provide important winter foraging for elk, mule deer and antelope, as sagebrush can approach 15% protein and 40-60% digestibility during that time. This community provides escape and thermal cover for large ungulates, as well as nesting and brood rearing habitat for sage grouse. Due to the lack of herbaceous production and diversity of mid cool season grasses on this site, it is not as beneficial to grazers. Other birds that would frequent this plant community include western meadowlark, lark bunting, sage thrasher, horned larks, red-tail and ferruginous hawks, and golden eagles.

Montana Wheatgrass/Three-tip Sagebrush Plant Community: The production of herbaceous species provided for good foraging to grazers. However, the lack of tall or mid growing shrubs does not benefit browsers nor provides cover for many wildlife species. As these site greens-up sooner in the spring, this site tends to provide early new growth for foraging large and small mammals. If located adjacent to shrub dominated sites, It provides good foraging habitat for sage grouse. Other birds that would frequent this plant community include western meadowlark, lark bunting, sage thrasher, horned larks, red-tail and ferruginous hawks, and golden eagles.

Rhizomatous Wheatgrass/Bluegrass Plant Community: The production of herbaceous species provided for good foraging for grazers. However, the lack of tall or mid growing shrubs does not benefit browsers nor provides cover for many wildlife species. As these site greens-up sooner in the spring, this site tends to provide early new growth for foraging large and small mammals. If located adjacent to shrub dominated sites, It provides good foraging habitat for sage grouse.

Bluegrass/Annual Plant Community: This community provides limited foraging for elk and other grazers. They may be used as a foraging site by sage grouse if proximal to woody cover. Generally, these are not target plant communities for wildlife habitat management.

Animal Community – Grazing Interpretations

The following table lists suggested stocking rates for cattle under continuous season-long grazing under normal growing conditions. These are conservative estimates that should be used only as guidelines in the initial stages of the conservation planning process. Often, the current plant composition does not entirely match any particular plant community (as described in this ecological site description). Because of this, a field visit is recommended, in all cases, to document plant composition and production. More precise carrying capacity estimates should eventually be calculated using this information along with animal preference data, particularly when grazers other than cattle are involved. Under more intensive grazing management, improved harvest efficiencies can result in an increased carrying capacity. If distribution problems occur, stocking rates must be reduced to maintain plant health and vigor.

Plant Community Production Carrying Capacity*

(lb./ac) (AUM/ac)

Idaho Fescue/Columbia Needlegrass 500-1000 .4

Bluebunch WG/Mixed Sagebrush 450-950 .35

Rhizomatous WG/Mixed Sagebrush 400-800 .3

Mixed Shrub/Bluegrass 300-700 .2

Montana WG/Three-tip Sagebrush 450-900 .3

Rhizomatous WG/ Bluegrass 350-750 .2

Bluegrass/Annual 200-500 .1

* - Continuous, season-long grazing by cattle under average growing conditions.

Grazing by domestic livestock is one of the major income-producing industries in the area. Rangeland in this area may provide forage for cattle, sheep, or horses. During the dormant period, the forage for livestock use needs to be supplemented with protein because the quality does not meet minimum livestock requirements.

Hydrological functions

Climate is the principal factor limiting forage production on this site. This site is dominated by soils in hydrologic group D due to its shallow feature. Infiltration and runoff potential for this site varies from moderate to high depending on soil hydrologic group and water table. Runoff will be high on this site since the soil saturate easy and due to its shallow characteristic and water holding capacity. (Refer to Part 630, NRCS National Engineering

Handbook for detailed hydraulic information.

Rills and gullies should not typically be present. Water flow patterns should be barely distinguishable if at all present. Pedestals are only slightly present in association with bunchgrasses such as bluebunch wheatgrass. Litter typically falls in place, and signs of movement are not common. Chemical and physical crusts are rare to non-existent. Cryptogamic crusts are present, but only cover 1-2% of the soil surface.

Recreational uses

This site provides hunting opportunities for upland game species. The wide varieties of plants that bloom from spring until fall have an esthetic value that appeals to visitors. Other recreational uses may include hiking, camping, and mountain biking.

Wood products

No appreciable wood products are present on the site.

Other products

None noted.

Inventory data references

Information presented here has been derived from NRCS clipping data and other inventory data. Field observations from range trained personnel were also used. Those involved in developing this site include: Chris Krassin, Range Management Specialist, James Haverkamp, Range Management Specialist, Steven Gullion, Range Management Specialist, James Mischke, District Conservationist, and Everet Bainter, State Range Management Specialist. Other sources used as references include USDA NRCS Water and Climate Center, USDA NRCS National Range and Pasture Handbook, and USDA NRCS Soil Surveys from various counties.

Contributors

J. Haverkamp

Approval

Scott Woodall, 10/04/2019

Rangeland health reference sheet

Interpreting Indicators of Rangeland Health is a qualitative assessment protocol used to determine ecosystem condition based on benchmark characteristics described in the Reference Sheet. A suite of 17 (or more) indicators are typically considered in an assessment. The ecological site(s) representative of an assessment location must be known prior to applying the protocol and must be verified based on soils and climate. Current plant community cannot be used to identify the ecological site.

Author(s)/participant(s)	Ray Gullion, E. Bainter
Contact for lead author	ray.gullion@wy.usda.gov 307-347-2456
Date	05/07/2008
Approved by	E. Bainter
Approval date	
Composition (Indicators 10 and 12) based on	Annual Production

Indicators

1. **Number and extent of rills:** Due to the wide slope range associated with this site, the number and extent of rills will vary from none on sites with slopes of <9% to common on slopes of >25%.

2. **Presence of water flow patterns:** Due to the wide slope range associated with this site, water flow patterns will vary from barely observable on sites with slopes of <9% from broken and irregular in appearance to continuous on slopes >25%.

3. **Number and height of erosional pedestals or terracettes:** Not evident on slopes <9%. Erosional pedestals will be present with terracettes present at debris dams on slopes >9%.

4. **Bare ground from Ecological Site Description or other studies (rock, litter, lichen, moss, plant canopy are not bare ground):** Bare ground can range from 20 to 35%.

5. **Number of gullies and erosion associated with gullies:** Active gullies restricted to concentrated water flow patterns.

6. **Extent of wind scoured, blowouts and/or depositional areas:** Minimal to nonexistent.

7. **Amount of litter movement (describe size and distance expected to travel):** Little to no plant litter movement occurs on slopes <9%. Litter movement does occur on slopes >25%.

8. **Soil surface (top few mm) resistance to erosion (stability values are averages - most sites will show a range of values):** Plant cover and litter is at 65% or greater of soil surface and maintains soil surface integrity. Stability class anticipated to be 5.0 or greater.

9. **Soil surface structure and SOM content (include type of structure and A-horizon color and thickness):** Soil data is limited for this site. Soil OM of 1 to 2% is expected.

10. **Effect of community phase composition (relative proportion of different functional groups) and spatial distribution on infiltration and runoff:** Plant community consists of 75% grasses, 15% forbs, and 10% shrubs. Plant canopy, very slow to moderately slow infiltration rates, the amount of bare ground, and steepness of slopes results in a naturally high runoff rate on slopes of >25%.

11. **Presence and thickness of compaction layer (usually none; describe soil profile features which may be mistaken for compaction on this site):** No compaction layer would be expected except for the naturally occurring rooting restriction (bedrock or decomposing shale) at 10 to 20 inches.

12. **Functional/Structural Groups (list in order of descending dominance by above-ground annual-production or live**

foliar cover using symbols: >>, >, = to indicate much greater than, greater than, and equal to):

Dominant: Mid-stature bunch grasses

Sub-dominant: mid-stature rhizomatous grasses short stature grasses/grasslikes

Other: shrubs forbs

Additional:

13. **Amount of plant mortality and decadence (include which functional groups are expected to show mortality or decadence):** Minimal decadence, typically associated with shrub component.
-

14. **Average percent litter cover (%) and depth (in):** Average litter cover is 25 to 35% and depth of 0.25 to 0.5 inches. Litter cover is in contact with soil surface.
-

15. **Expected annual annual-production (this is TOTAL above-ground annual-production, not just forage annual-production):** English: 800 -1200 lb/ac (1000 lb/ac average); Metric: 896-1344 kg/ha (1120 kg/ha average).
-

16. **Potential invasive (including noxious) species (native and non-native). List species which BOTH characterize degraded states and have the potential to become a dominant or co-dominant species on the ecological site if their future establishment and growth is not actively controlled by management interventions. Species that become dominant for only one to several years (e.g., short-term response to drought or wildfire) are not invasive plants. Note that unlike other indicators, we are describing what is NOT expected in the reference state for the ecological site:** As this site deteriorates species such as rhizomatous wheatgrasses, bluegrasses, and big sagebrush will increase. Annual forbs and grasses such as cheatgrass will invade.
-

17. **Perennial plant reproductive capability:** All species are capable of reproducing, except in drought years.
-