

Ecological site EX043B23B174 Subirrigated (Sb) Absaroka Upper Foothills

Last updated: 10/04/2019
Accessed: 05/01/2024

General information

Provisional. A provisional ecological site description has undergone quality control and quality assurance review. It contains a working state and transition model and enough information to identify the ecological site.

MLRA notes

Major Land Resource Area (MLRA): 043B–Central Rocky Mountains

Major Land Resource Unit (MLRA) 43B: Central Rocky Mountains

43B – Central Rocky Mountains – The Central Rocky Mountains extends from northern Montana to southern extent of Wyoming and from Idaho to central Wyoming. The southern extent of 43B is comprised of a combination of metamorphic, igneous, and sedimentary mountains and foothills. Climatic changes across this extent are broad and create several unique breaks in the landscape.

Further information regarding MLRAs, refer to: United States Department of Agriculture, Natural Resources Conservation Service. 2006. Land Resource Regions and Major Land Resource Areas of the United States, the Caribbean, and the Pacific Basin. U.S. Department of Agriculture Handbook 296.
Available electronically at: http://www.nrcs.usda.gov/wps/portal/nrcs/detail/soils/ref/?cid=nrcs142p2_053624#handbook.

LRU notes

Land Resource Unit (LRU) 43B23B: Absaroka Upper Foothills

Based on the shifts in geology, precipitation patterns and other climatic factors, as well as elevations and vegetation, the Absaroka Range was divided into LRU 23. Further division of this LRU is necessary due to the gradient moving from the foothills to the summit, as well as aspect shifts (north/east face versus south/west face). Subset B is set for the higher elevations within the foothills, with 15 to 19 inches of precipitation. To verify or identify Subset B (the referenced subset for this ecological site), refer to the Wyoming LRU matrix key contained within the Ecological Site Key.

This particular LRU/Subset occurs along the eastern foothills of the Absaroka Range. This LRU starts north of Clark, WY and runs to the Thermopolis, WY area. Once the foothills cross into the Northern Beartooth Range, the climatic patterns and elevational changes shifts the plant community and allows for a break in LRU's near the Montana state line. As the LRU follows to the south and then tracks east to the intersection of the Absaroka Range and the Owl Creek Range, the face changes aspect and geology creating a shift in plant dynamics and a break in the LRU.

The extent of soils currently correlated to this ecological site does not fit within the digitized boundary. Many of the noted soils are provisional and will be reviewed and corrected in mapping update projects. Other map units are correlated as small inclusions within other MLRA's/LRU's based on elevation, landform, and biological references.

Moisture Regime: Typic Ustic

Temperature Regime: Frigid

Dominant Cover: Rangeland – Sagebrush Steppe (major species is Mountain Big Sagebrush)

Representative Value (RV) Effective Precipitation: 15-19 inches (381 – 483 mm)

RV Frost-Free Days: 37 - 80 days

Classification relationships

Relationship to Other Established Classification Systems:

National Vegetation Classification System (NVC):

2 Shrub & Herb Vegetation Class

2.B Temperate & Boreal Grassland & Shrubland Subclass

2.B.2 Temperate Grassland & Shrubland Formation

2.B.2.Na Western North American Grassland & Shrubland Division Division

M048 Central Rocky Mountain Montane-Foothill Grassland & Shrubland Macrogroup

G273 Central Rocky Mountain Lower Montane, Foothill & Valley Grassland Group

Ecoregions (EPA):

Level I: 10 North American Deserts Level II: 10.1 Cold Deserts

Level III: 10.1.18 Wyoming Basin

Level IV: 10.1.18.b Big Horn Basin and

10.1.18.d Foothills and Low Mountains

Ecological site concept

- Site influence by a water table below soil surface through the entire growing season (within 40 inches), and water may move over the surface from run-in but only for short periods.
- Slope is <6%
- Soils are:
 - Shallow, moderately deep, deep, or very deep (depth to restrictive layer is greater than 10" (25 cm).
 - Poorly to moderately well drained
 - Textures usually range from loamy sand to clay loam
 - Clay content is < 60% in mineral soil surface 4".
 - With an average particle size class < 40% clay
 - Not saline, sodic, or saline-sodic, gypsic

Associated sites

R043BY330WY	Overflow (Ov) 15-19" Foothills and Mountains East Precipitation Zone Overflow
R043BY378WY	Wetland (WL) 15-19" Foothills and Mountains East Precipitation Zone Wetland

Similar sites

R032XY374WY	Subirrigated (Sb) 10-14" East Precipitation Zone Subirrigated 10-14" Foothills and Basins East P.Z., 032XY374WY has lower production.
-------------	---

Table 1. Dominant plant species

Tree	Not specified
Shrub	(1) <i>Salix</i>
Herbaceous	(1) <i>Carex nebrascensis</i> (2) <i>Deschampsia cespitosa</i>

Legacy ID

R043BX674WY

Physiographic features

This site normally occurs on nearly level bottomlands and adjacent to perennial streams, springs and ponds.

Table 2. Representative physiographic features

Landforms	(1) Foothills > Alluvial fan (2) Foothills > Stream terrace (3) Foothills > Drainageway
Runoff class	Negligible to low
Flooding duration	Brief (2 to 7 days) to very brief (4 to 48 hours)
Flooding frequency	Rare to occasional
Ponding frequency	None
Elevation	1,829–2,743 m
Slope	0–6%
Water table depth	30–102 cm
Aspect	Aspect is not a significant factor

Climatic features

Annual precipitation and modeled relative effective annual precipitation ranges from 15 to 19 inches (381 – 483 mm). The normal precipitation pattern shows peaks in June tapering into September. This amounts to about 50% of the mean annual precipitation. Average snowfall is about 150 inches annually. Wide fluctuations may occur in yearly precipitation and result in more dry years than those with more than normal precipitation.

Because of the varied topography, the wind will vary considerably for different parts of the area. The wind is usually much lighter at the lower elevations and in the valleys as compared with the higher terrain. The average winter wind velocity is 8.5 mph while the summer wind velocity averages 7.5 mph. Winds during storms and on ridges may exceed 45 mph.

Temperatures show a wide range between summer and winter and between daily maximums and minimums, due to the high elevation and dry air, which permits rapid incoming and outgoing radiation. Cold air outbreaks from Canada in winter move rapidly from northwest to southeast and account for extreme minimum temperatures. Chinook winds may occur in winter and bring rapid rises in temperature. High winds are generally blocked by high mountains but occur in conjunction with thunderstorms, which are common in late summer. Growth of native cool-season plants begins about May 1 to May 15 and continues until about October 15.

For detailed information visit the Natural Resources Conservation Service National Water and Climate Center at <http://www.wcc.nrcs.usda.gov/>. Historically, "Crandall Creek" was the representative weather stations within this subset. However, "Sunshine 3NE" is the only available weather station within a close proximity in location and characteristics for this subset. The following graphs and charts are a collective sample representing the averaged normals and 30-year annual rainfall data for the selected weather stations from 1981 to 2010.

Table 3. Representative climatic features

Frost-free period (characteristic range)	40 days
Freeze-free period (characteristic range)	84 days
Precipitation total (characteristic range)	356 mm
Frost-free period (actual range)	40 days
Freeze-free period (actual range)	84 days
Precipitation total (actual range)	356 mm
Frost-free period (average)	40 days

Freeze-free period (average)	84 days
Precipitation total (average)	356 mm

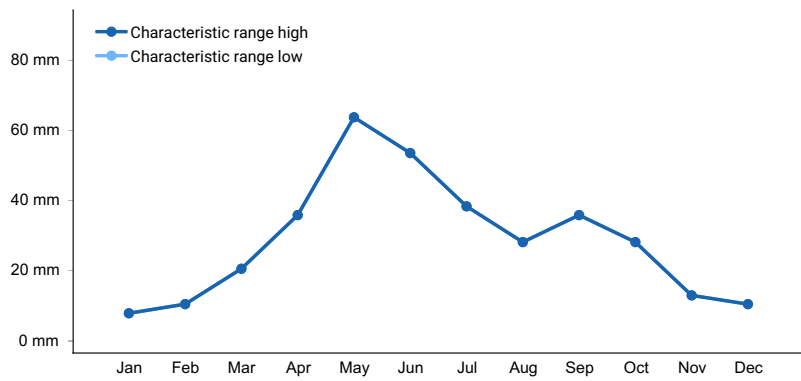

Figure 1. Monthly precipitation range

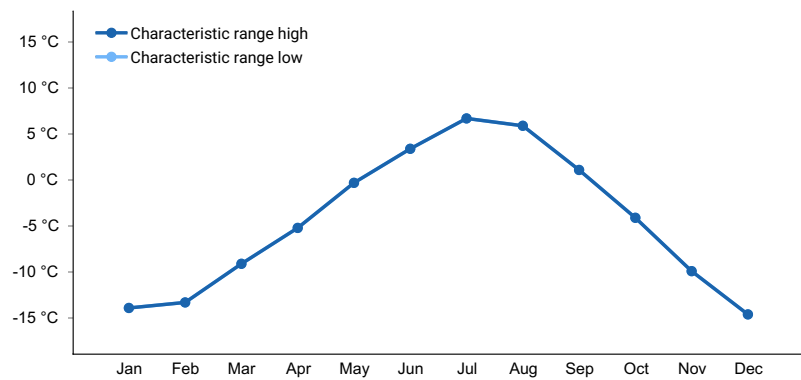

Figure 2. Monthly minimum temperature range

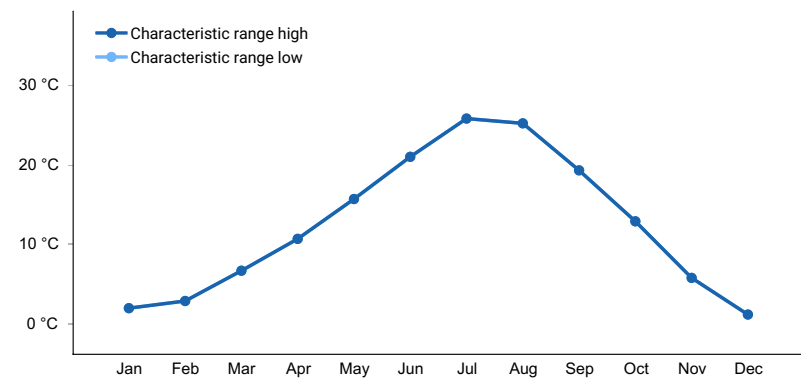

Figure 3. Monthly maximum temperature range

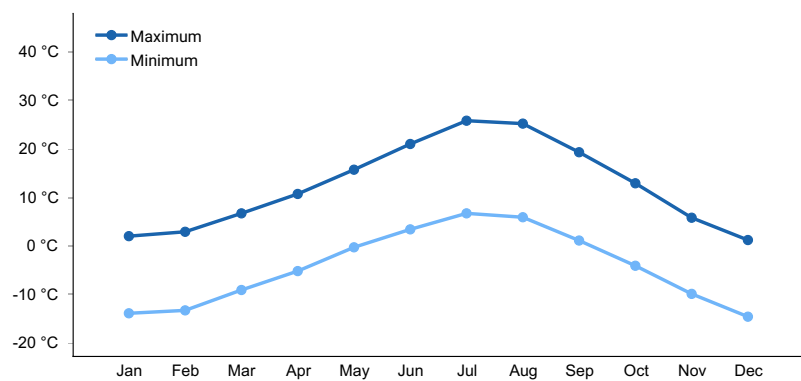

Figure 4. Monthly average minimum and maximum temperature

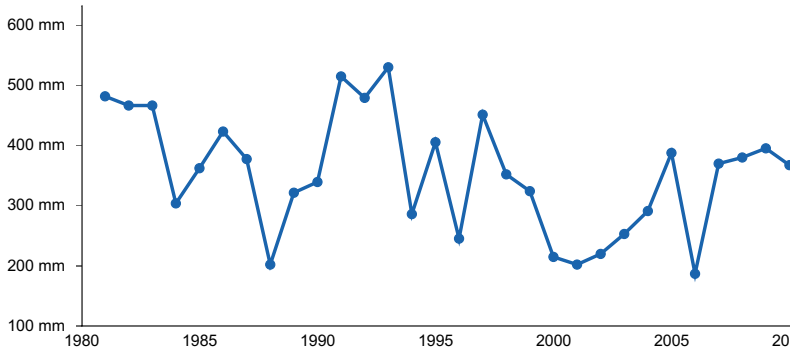

Figure 5. Annual precipitation pattern

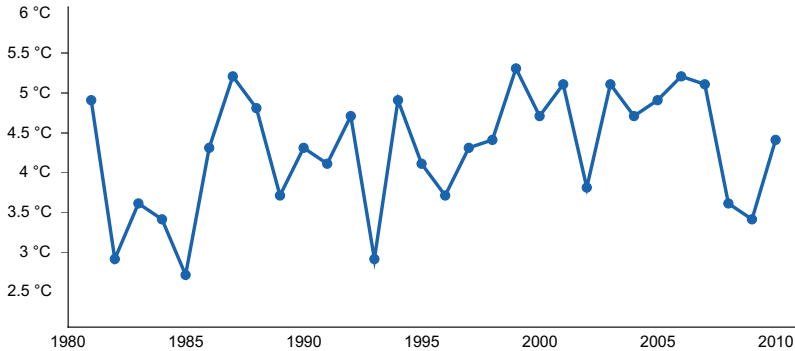

Figure 6. Annual average temperature pattern

Climate stations used

- (1) SUNSHINE 3NE [USC00488758], Meeteetse, WY

Influencing water features

The characteristics of these soils have influence from ground water that is within 40 inches of the soil surface and will be just below the surface for all of the growing season. Water over the surface from run-in may occur but only for short periods of time. These soils are moderately deep to deep and poorly to somewhat well drained.

Wetland description

No wetland classification determined for this site.
Stream Type: C (Rosgen)

Soil features

The soils of this site are moderately deep to very deep, poorly drained to moderately well-drained and formed in mixed alluvium. These soils have slow to rapid permeability. These soils are nonsaline and/or nonalkaline and with a water table within reach of the herbaceous species (usually less than three feet) through most of the growing season. These areas may have water over the surface from run-in but only for short periods. The soil characteristics having the most influence on the plant community are depth to a water table during the growing season.

Table 4. Representative soil features

Parent material	(1) Alluvium–sandstone and shale
Surface texture	(1) Cobbly, gravelly loam (2) Clay loam (3) Clay (4) Sandy loam (5) Loamy sand (6) Silty clay

Family particle size	(1) Coarse-loamy (2) Fine-loamy (3) Fine
Drainage class	Well drained to poorly drained
Permeability class	Slow to rapid
Soil depth	51–152 cm
Surface fragment cover <=3"	0–10%
Surface fragment cover >3"	0–10%
Available water capacity (0-101.6cm)	7.11–15.75 cm
Calcium carbonate equivalent (0-101.6cm)	0–5%
Electrical conductivity (0-101.6cm)	0–8 mmhos/cm
Sodium adsorption ratio (0-101.6cm)	0–10
Soil reaction (1:1 water) (0-101.6cm)	6.6–8.4
Subsurface fragment volume <=3" (Depth not specified)	0–10%
Subsurface fragment volume >3" (Depth not specified)	0–10%

Ecological dynamics

Potential vegetation on this site is dominated by plants that can tolerate soils that have a water table near the surface for most of the growing season. Significant vegetation includes tall and mid cool season grasses, grass-like species, and a variety of riparian shrubs and forbs. The expected potential composition for this site is about 70% grasses, 15% forbs and 15% woody plants. The composition and production will vary naturally due to historical use, fluctuating precipitation and fire frequency.

As this site deteriorates, species such as willows and forbs increase. Grasses and grasslikes such as tufted hairgrass, Nebraska sedge and northern reedgrass will decrease in frequency and production. As conditions continue to deteriorate species such as Kentucky bluegrass and annuals will invade.

Beaver can play a critical role in the maintenance or development of this site located along perennial streams. By modifying the water level through dams, the water table of an area is significantly increased and diverted water can replenish off channel areas such as oxbows, which can enhance subirrigation. Modifying water levels also promotes hydrophilic species while controlling upland species. Removal of beaver in areas has resulted in lowering of the water tables and channelization of waterways. Recently, reintroducing beaver to areas to stabilize riparian areas and create wet areas has gained popularity.

The Historic Climax Plant Community (description follows the plant community diagram) has been determined by study of rangeland relic areas, or areas protected from excessive disturbance. Trends in plant communities going from heavily grazed areas to lightly grazed areas, seasonal use pastures, and historical accounts have also been used.

The following is a State and Transition Model Diagram that illustrates the common plant communities (states) that can occur on the site and the transitions between these communities. The ecological processes will be discussed in more detail in the plant community narratives following the diagram.

State and transition model

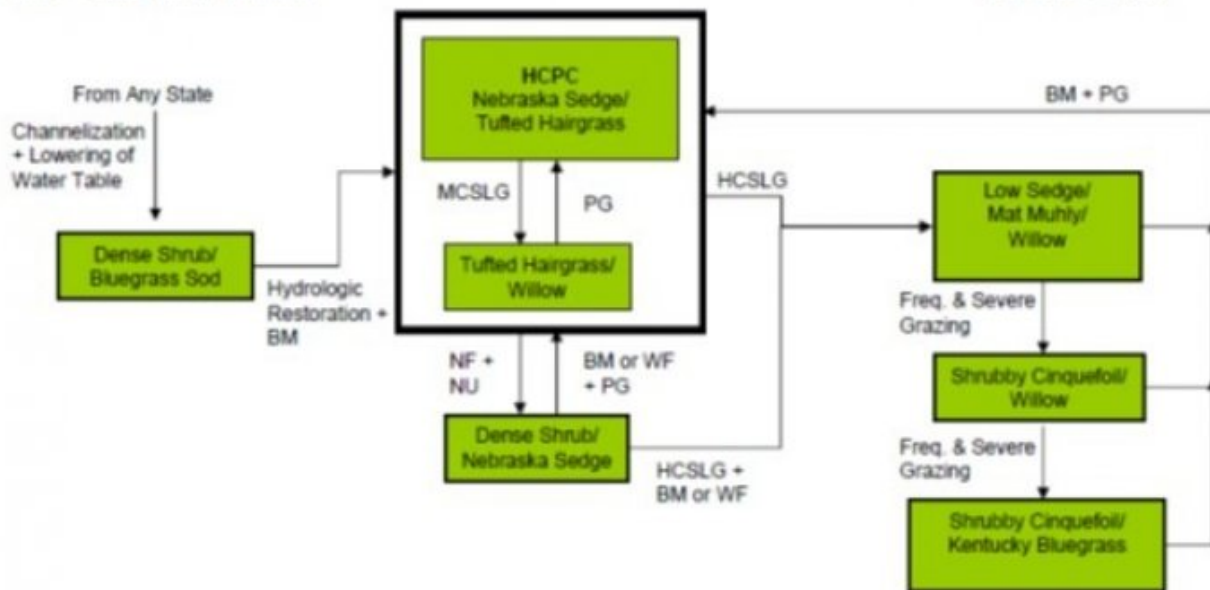

BM – Brush Management (fire, chemical, mechanical)
 Freq. & Severe Grazing – Frequent and Severe Utilization of the Cool-season Mid-grasses during the Growing Season
 GLMT – Grazing Land Mechanical Treatment
 LTPG – Long-term Prescribed Grazing
 MCSLG – Moderate, Continuous Season-long Grazing
 HCSLG – Heavy, Continuous Season-long Grazing
 NU, NF – No Use and No Fire
 PG – Prescribed Grazing (proper stocking rates with adequate recovery periods during the growing season)
 VLTPG – Very Long-term Prescribed Grazing (could possibly take generations)
 Na – Moderate Sodium in Soil
 WF - Wildfire

State 1 Nebraska Sedge/Tufted Hairgrass Plant Community

Community 1.1 Nebraska Sedge/Tufted Hairgrass Plant Community

The interpretive plant community for this site is the Historic Climax Plant Community. This site evolved with grazing by large herbivores, a water table within reach of the herbaceous plants through most of the growing season, and periodic fires. Potential vegetation is about 70% grasses or grass-like plants, 15% forbs and 15% woody plants. The major grasses and grasslikes include Nebraska sedge, tufted hairgrass, northern reedgrass, basin wildrye, and alpine timothy. Woody plants are mainly willows but other riparian shrubs and tree species occur. A variety of forbs occurs in this state as well and plant diversity is high (see Plant Composition Table). This state produces between 3000 and 4500 pounds annually, depending on the growing conditions. The state is extremely resilient and well adapted to the Central Rocky Mountains climatic conditions. The diversity in plant species allows for high drought resistance. This is a healthy and sustainable plant community (site/soil stability, watershed function, and biologic integrity). Transitions or pathways leading to other plant communities are as follows:

- Moderate, continuous season-long grazing will convert the plant community to the Tufted Hairgrass/Willow Plant Community.
- Heavy, continuous, season-long grazing will convert this plant community to Low Sedge/Mat Muhly/Willow Plant Community.
- No fire and No Use will convert the HCPC to the Dense Shrub/Nebraska Sedge Plant Community.
- Channelization and lowering of the Water Table will result in a Dense Shrub/Bluegrass Sod Plant Community.

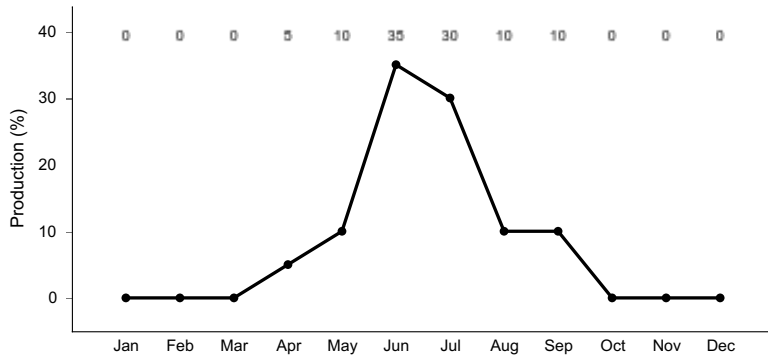

Figure 8. Plant community growth curve (percent production by month). WY0603, 15-19E Free water sites - WL, Sb. SS.

State 2 Tufted Hairgrass/Willow Plant Community

Community 2.1 Tufted Hairgrass/Willow Plant Community

Historically, this plant community evolved under grazing by large ungulates, a water table within reach of the herbaceous plants through most of the growing season, and a low fire frequency. Currently, this site is normally found under a moderate, season-long grazing regime and will be exacerbated by prolonged drought conditions. In addition, the fire regime for this site has been modified and extended periods without fire is now common. Willows are an important component of this plant community. Cool-season grasses and grasslikes make up the majority of the understory with the balance made up of miscellaneous forbs. Mid grass-like species and cool season tall and mid-grasses dominate this state. The major grasslike and grasses include tufted hairgrass, slender wheatgrass, alpine timothy, and of less frequency northern reedgrass, basin wildrye, and Nebraska sedge. Grasses and grasslikes of secondary importance include inland sedge, meadow barley, Baltic rush, big bluegrass, and Idaho fescue. Willows and other riparian shrubs comprise from 20% to 25% of the total annual production. When compared to the Historical Climax Plant Community, willows and other riparian shrubs, forbs, and bluegrasses have increased. Northern reedgrass, basin wildrye, and Nebraska sedge have decreased, often occurring only where protected from grazing by the shrub canopy. Some annual grasses and forbs may have invaded the site but are in small patches. This state produces between 2800 and 4300 pounds annually, depending on the growing conditions. This plant community is resistant to change. The herbaceous species present are well adapted to grazing; however, species composition can be altered through long-term overgrazing. The herbaceous component is mostly intact and plant vigor and replacement capabilities are sufficient. Water flow patterns and litter movement may be occurring but only on steeper slopes. Incidence of pedestalling is minimal. Soils are mostly stable and the surface shows minimum soil loss. The watershed is functioning and the biotic community is intact. Transitions or pathways leading to other plant communities are as follows:

- Prescribed grazing over the long-term will result in a plant community very similar to the Historic Climax Plant Community.
- Heavy, continuous, season-long grazing will convert this plant community to a Low Sedge/Mat Muhly/Willow Plant Community.
- No fire and No Use will convert the HCPC to the Dense Shrub/Nebraska Sedge Plant Community.
- Channelization and lowering of the Water Table will result in a Dense Shrub/Bluegrass Sod Plant Community.

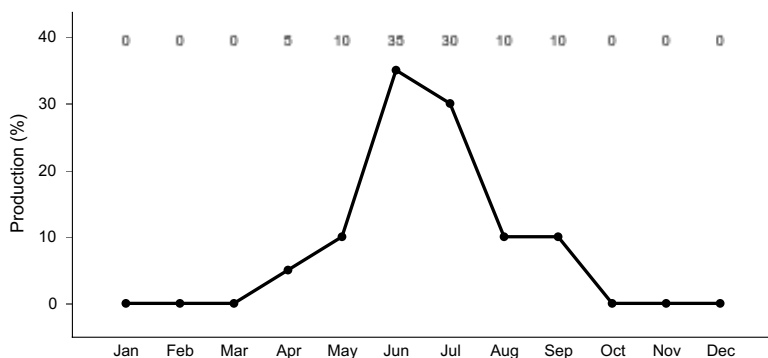

Figure 9. Plant community growth curve (percent production by month). WY0603, 15-19E Free water sites - WL, Sb. SS.

State 3 Dense Shrub/Nebraska Sedge Plant Community

Community 3.1 Dense Shrub/Nebraska Sedge Plant Community

This plant community results from little or no use and no fires over an extended period in the HCPC. Shrubs are a significant component of this plant community. Mid grasslikes and tall and mid cool-season grasses make up the majority of the understory, however, the shrub component has become so dominant that the area occupied by herbaceous species has been significantly reduced. Preferred grasses are still present but the frequency and production have been reduced. Dominant grasslikes and grasses include Nebraska sedge, tufted hairgrass, northern reedgrass, basin wildrye, and alpine timothy. Grasses and grass-likes of secondary importance include inland sedge, meadow barley, Baltic rush, big bluegrass, and Idaho fescue. Forbs commonly found in this plant community include American bistort, American licorice, buttercup, mint, clovers, geranium, fragrant bedstraw, wild strawberry, violets, alpine avens, and water hemlock. A wide variety of shrubs can be present and will exceed 30% of the total production. Shrubs include mainly willows as well as others such as dogwood, chokecherry, currant, wild rose, water birch, thinleaf alder, and boxelder. When compared to the Historic Climax Plant Community, shrubs have significantly increased. Most of the preferred grasses and grasslikes are present in areas not dominated by shrubs. The increase in shrub production has offset some of the loss in the herbaceous production. Annual production ranges from 2800 to 4300 pounds. This plant community is resistant to change as the shrubs become more abundant. The herbaceous component is as diverse and plant vigor and species regeneration capabilities of preferred species are sufficient. Some plants may become overly mature especially some of the shrubs. Browsing may increase the opening for the preferred herbaceous plants, however, over grazing is possible if prescribed grazing is not implemented. Water flow patterns and litter movement is normal. Incidence of pedestalling is not occurring. Soils are stable and the surface shows minimum or no soil loss. The watershed is functioning and the biotic community is intact. Transitions or pathways leading to other plant communities are as follows: • Prescribed grazing and wildfire or brush management will convert this plant community to the HCPC. The probability of this occurring is high especially if brush management is used with rotational grazing along with deferred grazing as part of the prescribed method of use. In addition, the removal of fire suppression will allow a somewhat natural fire regime to reoccur to more easily transition between this plant community and the HCPC. • Brush management or Wildfire with Heavy, continuous, season-long grazing will convert this plant community to the Low Sedge/Mat Muhly/Willow Plant Community. • Channelization and lowering of the Water Table will result in a Dense Shrub/Bluegrass Sod Plant Community.

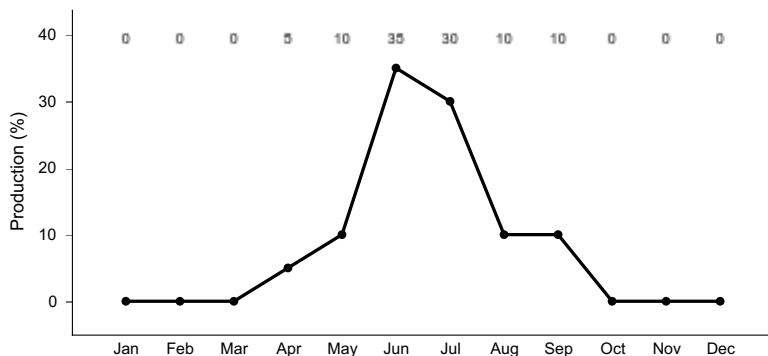

Figure 10. Plant community growth curve (percent production by month). WY0603, 15-19E Free water sites - WL, Sb. SS.

State 4 Low Sedge/Mat Muhly/Willow Plant Community

Community 4.1 Low Sedge/Mat Muhly/Willow Plant Community

This plant community currently is found under heavy continuous season-long grazing by livestock. Shrubs are a significant component of this plant community. Mid grasses and low sedges make up the majority of the understory, but some of the preferred grasses and grasslikes have been reduced or absent. Dominant grasslikes and grasses include low sedge, mat muhly, Idaho fescue, big bluegrass, and Baltic rush. Grasses and grasslikes of less

frequency are Nebraska sedge, tufted hairgrass, northern reedgrass, basin wildrye, and alpine timothy. Forbs commonly found in this plant community include American bistort, American licorice, buttercup, mint, clovers, geranium, fragrant bedstraw, wild strawberry, violets, alpine avens, and water hemlock. Other weedy annual species may include cocklebur, sowhistle, prickly lettuce, curly dock, common milkweed, stickseed, and a variety of thistles. A wide variety of shrubs can be present and will exceed 20% of the total production. Shrubs include mainly willows and others such as dogwood, chokecherry, currant, wild rose, water birch, thinleaf alder, and boxelder. When compared to the Historic Climax Plant Community, shrubs, bluegrasses, low sedges, and mat muhly have increased. Most of the preferred grasses and grasslikes have been reduced or removed. The increase in shrub production has offset some of the loss in the herbaceous production. Annual production ranges from 2300 to 3500 pounds. This plant community is resistant to change as the shrubs become more abundant. The herbaceous component is not as diverse and plant vigor and species regeneration capabilities of some cool-season perennials and mid sedges are deficient. The removal of grazing does not seem to affect the plant composition or structure of the plant community. Soil erosion may be accelerated because of increased bare ground. In areas where sod forming plants have become more dominant water infiltration has decreased. While these patches of sod protect the area itself, off-site areas are affected by excessive runoff that can cause rills and gully erosion. Water flow patterns are obvious in the bare ground areas and pedestalling is apparent along these sodded edges and around shrubs. Hummocks may be noticeable. In general, infiltration is reduced and runoff is increased as the soils become more compacted. Rill channels may be noticeable in the interspaces on steeper areas and gullies may be establishing where rills have concentrated down slope. Transitions or pathways leading to other plant communities are as follows: • Prescribed grazing plus brush management will convert this plant community to near HCPC. If prescribed fire is used as a means to reduce or remove the shrubs, sufficient fine fuels will need to be present. This may require deferment from grazing prior to treatment. Post management is critical to ensure success. This can range from two or more years of rest to partial growing season deferment, depending on the condition of the understory at the time of treatment and the growing conditions following treatment. Seeding will often be required regardless of the brush treatment to reestablish the major cool-season grasses. • Frequent and severe grazing will convert this plant community to the Shrubby Cinquefoil/Willow Plant Community. • Channelization and lowering of the Water Table will result in a Dense Shrub/Bluegrass Sod Plant Community.

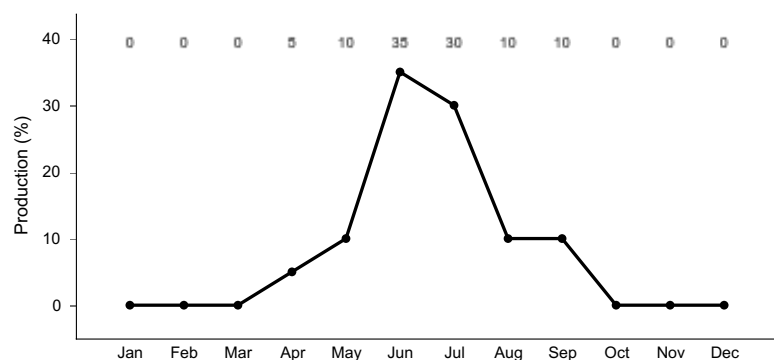

Figure 11. Plant community growth curve (percent production by month). WY0603, 15-19E Free water sites - WL, Sb. SS.

State 5 Shrubby Cinquefoil/Willow Plant Community

Community 5.1 Shrubby Cinquefoil/Willow Plant Community

This plant community is the result of frequent and severe grazing and protection from fire. Shrubby cinquefoil, willows and a variety of other shrubs can dominate this plant community as the annual production will exceed 30%. The preferred cool season grasses have been eliminated or greatly reduced. A sod of bluegrass and rhizomatous grasses can dominate the interspaces between shrubs. On areas without this sod, interspaces are usually bare ground. The dominant grasses are bluegrass such as big and Kentucky. Weedy annual species such cocklebur, sowhistle, prickly lettuce, curly dock, common milkweed, stickseed, and a variety of thistles can occupy the site. Noxious weeds such as Canada thistle, white top, and leafy spurge may invade the site, if a seed source is available. When compared with the HCPC, the annual production is less as the major grasslikes and grasses are reduced and replaced by lower growing sod grasses and sedges. The shrub composition has changed as more preferred shrubs have either been removed or significantly altered and replaced with shrubby cinquefoil and other

less preferred species. In general, total production by shrubs have increased, which compensates for some of the decline in the herbaceous production. Annual production ranges from 1800 to 2800 pounds. This plant community is resistant to change as the stand becomes more decadent and the sodded areas, which are extremely resistant to change, expand. Continued frequent and severe grazing or the removal of grazing does not seem to affect the plant composition or structure of the plant community. The herbaceous component is not as diverse and plant vigor and species regeneration capabilities of cool-season perennials are deficient. Soils are unstable on areas where bare ground has increased and erosion is accelerating. Soil compaction is apparent and hummocks are noticeable. Likewise, on areas where sod forming plants become more dominant, water infiltration is restricted. While these patches of sod protect the area itself, off-site areas are affected by excessive runoff that can cause rills and gully erosion. Water flow patterns are obvious in the bare ground areas and pedestalling is apparent along these sodded edges and bushes. In general, infiltration is reduced and runoff is increased as the soils become more compacted. The rill channels may be noticeable in the interspaces on steeper areas and gullies may be establishing where rills have concentrated down slope. Transitions or pathways leading to other plant communities are as follows: • Prescribed grazing plus brush management will convert this plant community to near HCPC. If prescribed fire is used as a means to reduce or remove the shrubs, sufficient fine fuels will need to be present. This may require deferment from grazing prior to treatment. Post management is critical to ensure success. This can range from two or more years of rest to partial growing season deferment, depending on the condition of the understory at the time of treatment and the growing conditions following treatment. Seeding will often be required regardless of the brush treatment to reestablish the major cool-season grasses. • Frequent and severe grazing will convert this plant community to the Shrubby Cinquefoil/Kentucky Bluegrass Plant Community. • Channelization and lowering of the Water Table will result in a Dense Shrub/Bluegrass Sod Plant Community.

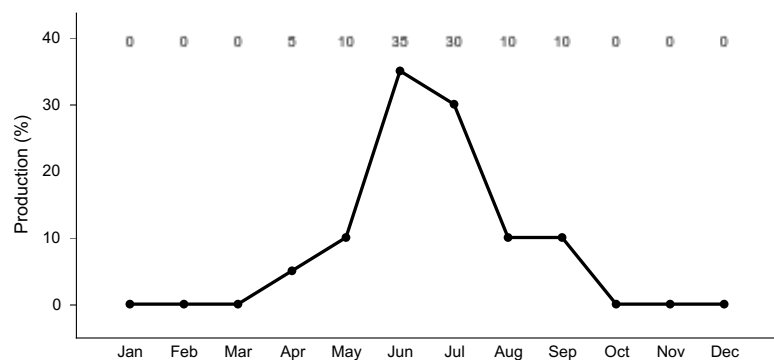

Figure 12. Plant community growth curve (percent production by month). WY0603, 15-19E Free water sites - WL, Sb. SS.

State 6 Shrubby Cinquefoil/Kentucky Bluegrass Plant Community

Community 6.1 Shrubby Cinquefoil/Kentucky Bluegrass Plant Community

This plant community is the result of frequent and severe grazing and protection from fire. Shrubby cinquefoil, and a variety of other shrubs can dominate this plant community as the annual production will exceed 30%. Willows have been severely browsed and may have been removed. The preferred grasses have been eliminated. A sod of bluegrass dominates the interspaces between shrubs. On areas without this sod, interspaces are usually bare ground. The dominant grasses and grasslikes are bluegrasses and foxtail barley. Weedy annual species such as cocklebur, sowhistle, prickly lettuce, curly dock, common milkweed, stickseed, and a variety of thistles can occupy the site. Noxious weeds such as Canada thistle, white top, and leafy spurge may invade the site if a seed source is available. When compared with the HCPC, the annual production is significantly less as the major grasslikes and grasses are removed and replaced by less productive species. The shrub composition has changed as more preferred shrubs have either been removed or significantly altered and replaced with shrubby cinquefoil and other less preferred species. In general, total production by shrubs have increased, which compensates for some of the decline in the herbaceous production. Annual production ranges from 1800 to 2800 pounds. This plant community is resistant to change as the shrubs and sod grasses become denser. Continued frequent and severe grazing or the removal of grazing does not seem to affect the plant composition or structure of the plant community. Weedy species and bare ground compromise the biotic integrity. Plant diversity is poor and the potential for native grasses to reproduce is absent. The shift in the vegetative structure and function is extreme and the biotic integrity is lost.

Soils are unstable on areas where bare ground has increased and erosion is accelerating. Soil compaction is apparent and hummocks are noticeable. Likewise, on areas where sod forming plants become more dominant, water infiltration is restricted. While these patches of sod protect the area itself, off-site areas are affected by excessive runoff that can cause rills and gully erosion. Water flow patterns are obvious in the bare ground areas and pedestalling is apparent along these sodded edges. In general, infiltration is reduced and runoff is increased as the soils become more compacted. The rill channels are noticeable in the interspaces and gullies are typical where rills have concentrated down slope. Transitions or pathways leading to other plant communities are as follows: • Prescribed grazing plus brush management will convert this plant community to near HCPC. If prescribed fire is used as a means to reduce or remove the shrubs, sufficient fine fuels will need to be present. This may require deferment from grazing prior to treatment. Post management is critical to ensure success. This can range from two or more years of rest to partial growing season deferment, depending on the condition of the understory at the time of treatment and the growing conditions following treatment. Seeding will often be required regardless of the brush treatment to reestablish the major cool-season grasses. • Channelization and lowering of the Water Table will result in a Dense Shrub/Bluegrass Sod Plant Community.

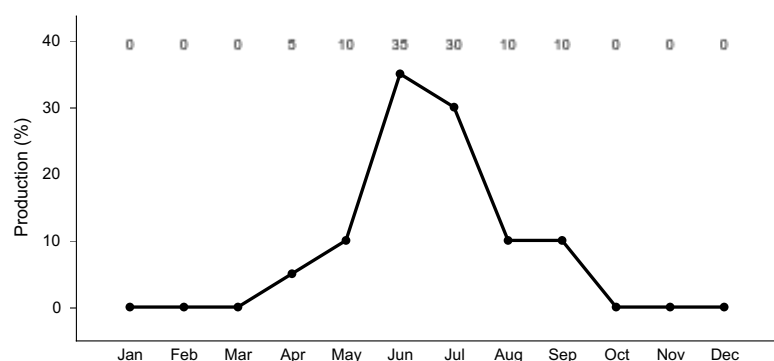

Figure 13. Plant community growth curve (percent production by month).
WY0603, 15-19E Free water sites - WL, Sb. SS.

State 7 Dense Shrub/Bluegrass Sod Plant Community

Community 7.1 Dense Shrub/Bluegrass Sod Plant Community

This plant community evolved as a result of channelization or down cutting of an adjacent water course. The disruption in the natural hydrologic regime is either directly caused by humans, such as dams or dikes, or indirectly through accelerated erosion and channelization. Extended periods of drought will exacerbate this situation. Upland plants are more pronounced and deep-rooted shrub species, which can benefit from the deeper water table, dominate. Big and/or silver sagebrush and/or rubber rabbitbrush occur on drier warmer sites and a mixture of sagebrush and isolated patches of riparian species occur on cooler wetter sites. Tall and medium cool season grasses and grasslikes such as mid sedges have been reduced or eliminated. Dense sod patches of grasses, mostly Kentucky bluegrass, occur amongst the shrubs and bare ground. The annual grasses and upland forbs are more prevalent along with noxious weeds such as leafy spurge, Canada thistle and Russian knapweed. Total annual production is mostly from shrubs and sod forming grasses. Shrubs can be greater than 40% of the total annual production. When compared with the HCPC, the annual production is significantly reduced but the dense shrub component makes up for some of this loss in total production. Annual production ranges from 700 to 1000 pounds. This plant community is resistant to change as the shrub stand and the sod become denser. Continued frequent and severe grazing or the removal of grazing does not seem to affect the plant composition or structure of the plant community. Weedy species and bare ground compromise the biotic integrity. Plant diversity is poor and the potential for preferred species to reproduce is absent. The shift in the vegetative structure and function is extreme and the biotic integrity is lost. The hydrologic integrity of the site has been severely altered as the water table is now below the rooting depth of the herbaceous species. The soil of this state is somewhat protected where the sod patches are located and the dense shrubs occur, but erosion has accelerated in places between the patches where bare ground may be common. Water flow patterns and pedestalling are obvious and may be numerous. Remnant hummocks may be present. Infiltration is reduced and runoff is increased. Rill channels are noticeable in the interspaces and gullies and head cuts are typical. Transitions or pathways leading to other plant communities are as follows: • Hydrologic restoration and brush management will convert this plant community in to the HCPC.

Restoring the hydrological function of an area is usually very expensive and may take many years. This may require reintroducing both periodic flooding and an overflow regime. If practical and if the habitat is favorable, reintroducing beaver may be a part of the solution. Brush management typically is necessary to remove shrubs and specifically upland shrubs if they have encroached.

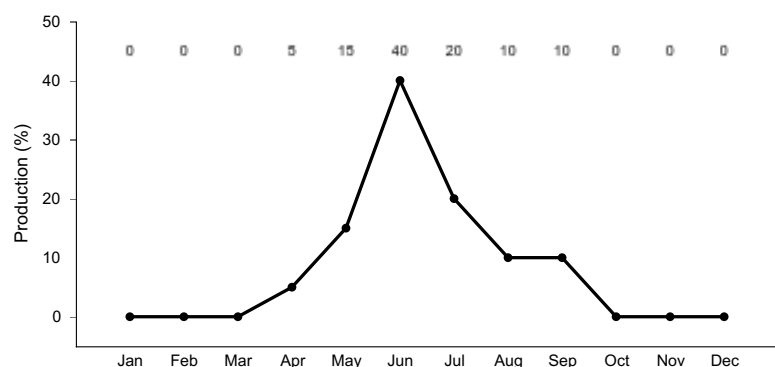

Figure 14. Plant community growth curve (percent production by month). WY0601, 15-19E all upland sites.

Additional community tables

Table 5. Community 1.1 plant community composition

Group	Common Name	Symbol	Scientific Name	Annual Production (Kg/Hectare)	Foliar Cover (%)
Grass/Grasslike					
1				639–1065	
	Nebraska sedge	CANE2	<i>Carex nebrascensis</i>	639–1065	–
2				426–852	
	tufted hairgrass	DECE	<i>Deschampsia cespitosa</i>	426–852	–
3				213–639	
	basin wildrye	LECI4	<i>Leymus cinereus</i>	213–639	–
4				0–426	
	northern reedgrass	CASTI3	<i>Calamagrostis stricta ssp. inexpansa</i>	0–426	–
5				0–426	
	alpine timothy	PHAL2	<i>Phleum alpinum</i>	0–426	–
6				0–426	
	slender wheatgrass	ELTR7	<i>Elymus trachycaulus</i>	0–426	–
7				0–426	
	Grass, perennial	2GP	<i>Grass, perennial</i>	0–213	–
	inland sedge	CAIN11	<i>Carex interior</i>	0–213	–
	sedge	CAREX	<i>Carex</i>	0–213	–
	Idaho fescue	FEID	<i>Festuca idahoensis</i>	0–213	–
	meadow barley	HOBR2	<i>Hordeum brachyantherum</i>	0–213	–
	rush	JUNCU	<i>Juncus</i>	0–213	–
	mat muhly	MURI	<i>Muhlenbergia richardsonis</i>	0–213	–
Forb					
8				426–639	
	Forb, perennial	2FP	<i>Forb, perennial</i>	0–213	–
	yarrow	ACHIL	<i>Achillea</i>	0–213	–
	milkvetch	ASTRA	<i>Astragalus</i>	0–213	–

	COMMON NAME	ACRONYM	Scientific Name	HEIGHT	FRUIT
	water hemlock	CICUT	<i>Cicuta</i>	0-213	-
		DEOC	<i>Delphinium occidentale</i>	0-213	-
	horsetail	EQUIS	<i>Equisetum</i>	0-213	-
	fleabane	ERIGE2	<i>Erigeron</i>	0-213	-
	aster	EUCEP2	<i>Eucephalus</i>	0-213	-
	woodland strawberry	FRVE	<i>Fragaria vesca</i>	0-213	-
	fragrant bedstraw	GATR3	<i>Galium triflorum</i>	0-213	-
	geranium	GERAN	<i>Geranium</i>	0-213	-
	Ross' avens	GERO2	<i>Geum rossii</i>	0-213	-
	American licorice	GLLE3	<i>Glycyrrhiza lepidota</i>	0-213	-
	common cowparsnip	HEMA80	<i>Heracleum maximum</i>	0-213	-
	flax	LINUM	<i>Linum</i>	0-213	-
	tall fringed bluebells	MECI3	<i>Mertensia ciliata</i>	0-213	-
	mint	MENTH	<i>Mentha</i>	0-213	-
	common plantain	PLMA2	<i>Plantago major</i>	0-213	-
	American bistort	POBI6	<i>Polygonum bistortoides</i>	0-213	-
	buttercup	RANUN	<i>Ranunculus</i>	0-213	-
	dock	RUMEX	<i>Rumex</i>	0-213	-
	claspleaf twistedstalk	STAM2	<i>Streptopus amplexifolius</i>	0-213	-
	groundsel	TEPHR3	<i>Tephrosia</i>	0-213	-
	goldenbanner	THERM	<i>Thermopsis</i>	0-213	-
	clover	TRIFO	<i>Trifolium</i>	0-213	-
	violet	VIOLA	<i>Viola</i>	0-213	-
Shrub/Vine					
9				0-426	
	willow	SALIX	<i>Salix</i>	0-426	-
10				0-426	
	Shrub (>.5m)	2SHRUB	<i>Shrub (>.5m)</i>	0-213	-
	boxelder	ACNEI2	<i>Acer negundo var. interius</i>	0-213	-
	gray alder	ALIN2	<i>Alnus incana</i>	0-213	-
	water birch	BEOC2	<i>Betula occidentalis</i>	0-213	-
	redosier dogwood	COSE16	<i>Cornus sericea</i>	0-213	-
	chokecherry	PRVIV	<i>Prunus virginiana var. virginiana</i>	0-213	-
	currant	RIBES	<i>Ribes</i>	0-213	-
	Woods' rose	ROWOW	<i>Rosa woodsii var. woodsii</i>	0-213	-

Animal community

Animal Community – Wildlife Interpretations

Nebraska Sedge/Tufted Hairgrass Plant Community (HCPC): The predominance of grasses and grasslikes in this plant community favors grazers and mixed-feeders, such as deer, moose, bison, elk, and antelope. Suitable thermal and escape cover for these species may be limited due to the low quantities of woody plants. These sites are also important corridors within the foot slopes of mountains and between valuable water sources for many wildlife species. When found adjacent to sagebrush dominated states, this plant community may provide brood

rearing/foraging areas for sage grouse, as well as lek sites. Other birds that would frequent this plant community include many nesting species, blue grouse, American kestrel, hawks, and golden eagle. As these sites are adjacent to water, bald eagles, Wilson's phalarope, sandhill crane, great blue heron, waterfowl, and kingfishers can be found frequenting the site. Many small mammals occur here including water species such as muskrat, beaver and river otter.

Tufted Hairgrass/Willow Plant Community: The combination of an overstory of shrubs and an understory of grasses, grasslikes, and forbs provides a very diverse plant community for wildlife. The shrubs tend to break up hard crusted snow and many of these provide important sources of food for many wildlife species. Consequently, many large mammals use this state for foraging and cover year-round. These sites are also important corridors within the foot slopes of mountains and between upland sites and valuable water sources for many wildlife species. It provides important winter habitat for sage grouse. Other birds that would frequent this plant community include nesting species, blue grouse, American kestrel, hawks, and golden eagle. As these sites are adjacent to water, bald eagles, Wilson's phalarope, sandhill crane, great blue heron, waterfowl, and kingfishers can be found frequenting the site. Many small mammals occur here including water species such as muskrat, beaver and river otter.

Dense Shrub/Nebraska Sedge Plant Community: The combination of an overstory of shrubs and an understory of grasses and forbs provides a very diverse plant community for wildlife. The shrubs tend to break up hard crusted snow and many of these provide important sources of food for many wildlife species. Consequently, many large mammals use this state for foraging and cover year-round. These sites are also important corridors within the foot slopes of mountains and between upland sites and valuable water sources. It provides important winter foraging habitat for sage grouse. Other birds that would frequent this plant community include nesting species, blue grouse, American kestrel, hawks, and golden eagle. As these sites are adjacent to water, bald eagles, Wilson's phalarope, sandhill crane, great blue heron, waterfowl, and kingfishers can be found frequenting the site. Many small mammals occur here including water species such as muskrat, beaver and river otter.

Low Sedge/Mat Muhly/ Willows Plant Community: The combination of an overstory of shrubs and an understory of grasses and forbs provides a very diverse plant community for wildlife. The shrubs tend to break up hard crusted snow and many of these provide important sources of food for many wildlife species. Consequently, many large mammals use this state for foraging and cover year-round. These sites are also important corridors within the foot slopes of mountains and between upland sites and valuable water sources. It provides important foraging habitat for sage grouse. Other birds that would frequent this plant community include nesting species, blue grouse, American kestrel, hawks, and golden eagle. As these sites are adjacent to water, bald eagles, Wilson's phalarope, sandhill crane, great blue heron, and waterfowl can be found frequenting the site. Many small mammals occur here including water species such as muskrat, beaver and river otter.

Shrubby Cinquefoil/Willow Plant Community: The increase in the overstory of shrubs provides for increase in year round cover and browsing selections for wildlife. The shrubs tend to break up hard crusted snow and many of these provide important sources of food for many wildlife species. However, due to the lack of herbaceous production and diversity of mid cool season grasses and grasslikes, this site is less beneficial to grazers. These sites are important corridors within the foot slopes of mountains and between upland sites and valuable water sources for many wildlife species. It provides important winter, nesting, brood-rearing, and foraging habitat for sage grouse. Other birds that would frequent this plant community include nesting species, American kestrel, hawks, and golden eagle. As these sites are adjacent to water, bald eagles, Wilson's phalarope, sandhill crane, great blue heron, and waterfowl can be found frequenting the site. Many small mammals occur here including water species such as muskrat, beaver and river otter.

Shrubby Cinquefoil/Kentucky Bluegrass Plant Community: The lack of tall or mid growing shrubs does not provide cover for many species and the only shrub is not used by most large mammals. As these areas tend to greens-up sooner in the spring, these sites provide early new growth for foraging large and small mammals. Generally, these are not target plant communities for wildlife habitat management.

Dense Shrub/Bluegrass Sod Plant Community: The increase in the overstory of shrubs provides for an increase in year round cover and browsing selections for wildlife. The shrubs tend to break up hard crusted snow and many of these provide important sources of food for many wildlife species. However, due to the lack of herbaceous production and diversity of mid cool season grasses and grasslikes, this site is less beneficial to grazers. These sites are important corridors within the foot slopes of mountains and between upland sites and valuable water sources for many wildlife species. It provides important winter, nesting, brood-rearing, and foraging habitat for sage

grouse. However, as the hydrology of the area has been significantly altered less water dependent species frequent the site. In addition, with the shift to more upland plants more upland species may be present.

Animal Community – Grazing Interpretations

The following table lists suggested stocking rates for cattle under continuous season-long grazing under normal growing conditions. These are conservative estimates that should be used only as guidelines in the initial stages of the conservation planning process. Often, the current plant composition does not entirely match any particular plant community (as described in this ecological site description). Because of this, a field visit is recommended, in all cases, to document plant composition and production. More precise carrying capacity estimates should eventually be calculated using this information along with animal preference data, particularly when grazers other than cattle are involved. Under more intensive grazing management, improved harvest efficiencies can result in an increased carrying capacity. If distribution problems occur, stocking rates must be reduced to maintain plant health and vigor.

Plant Community Production Carrying Capacity*

(Lb./ac) (AUM/ac)

Nebraska Sedge/Tufted Hairgrass 3000-4500 2.0

Tufted Hairgrass/Willow 2800-4300 1.7

Dense Shrub/ Nebraska Sedge 2800-4300 1.5

Low Sedge/Mat Muhly/Willow 2300-3500 1.5

Shrubby Cinquefoil/Willow 1800-2800 1.0

Shrubby Cinquefoil/Kentucky Bluegrass 1800-2800 .6

Dense Shrub/Bluegrass Sod 700-1000 .4

* - Continuous, season-long grazing by cattle under average growing conditions.

Grazing by domestic livestock is one of the major income-producing industries in the area. Rangeland in this area may provide forage for cattle, sheep, or horses. During the dormant period, the forage for livestock use needs to be supplemented with protein because the quality does not meet minimum livestock requirements.

Hydrological functions

Climate is the principal factor limiting forage production on this site. This site is dominated by soils in hydrologic group D. Infiltration and runoff potential for this site varies from moderate to high depending on soil hydrologic group and water table. Runoff will be high on this site since the soil is usually saturated. (Refer to Part 630, NRCS National Engineering Handbook for detailed hydraulic information.

Rills and gullies should not typically be present. Water flow patterns should be barely distinguishable if at all present. Pedestals are only slightly present in association with bunchgrasses. Litter typically falls in place, and signs of movement are not common. Chemical and physical crusts are rare to non-existent. Cryptogamic crusts are present, but only cover 1-2% of the soil surface.

Recreational uses

This site provides hunting opportunities for upland game and water species. Sites adjacent to perennial stream provide opportunities for fishing and water activities. The wide varieties of plants that bloom from spring until fall have an esthetic value that appeals to visitors. Other recreational uses may included hiking, camping, mountain biking, and in the winter snowshoeing and cross-country skiing.

Wood products

No appreciable wood products are present on the site.

Other products

None noted.

Inventory data references

Information presented here has been derived from NRCS clipping data and other inventory data. Field observations from range trained personnel were also used. Those involved in developing this site include: Chris Krassin, Range Management Specialist, James Haverkamp, Range Management Specialist, Steven Gullion, Range Management Specialist, James Mischke, District Conservationist, and Everet Bainter, State Range Management Specialist. Other sources used as references include USDA NRCS Water and Climate Center, USDA NRCS National Range and Pasture Handbook, and USDA NRCS Soil Surveys from various counties.

Contributors

J. Haverkamp

Approval

Scott Woodall, 10/04/2019

Rangeland health reference sheet

Interpreting Indicators of Rangeland Health is a qualitative assessment protocol used to determine ecosystem condition based on benchmark characteristics described in the Reference Sheet. A suite of 17 (or more) indicators are typically considered in an assessment. The ecological site(s) representative of an assessment location must be known prior to applying the protocol and must be verified based on soils and climate. Current plant community cannot be used to identify the ecological site.

Author(s)/participant(s)	Ray Gullion, E. Bainter
Contact for lead author	ray.gullion@wy.usda.gov 307-347-2456
Date	05/01/2008
Approved by	E. Bainter
Approval date	
Composition (Indicators 10 and 12) based on	Annual Production

Indicators

1. **Number and extent of rills:** Rare to nonexistent.
-

2. **Presence of water flow patterns:** Water flow patterns sometimes evident in floodplain zone where this site occurs.
-

3. **Number and height of erosional pedestals or terracettes:** Rare to nonexistent.
-

4. **Bare ground from Ecological Site Description or other studies (rock, litter, lichen, moss, plant canopy are not bare ground):** Bare ground is typically less than 5%.
-

5. **Number of gullies and erosion associated with gullies:** Active gullies should not be present.
-

6. **Extent of wind scoured, blowouts and/or depositional areas:** Minimal to nonexistent.
-
7. **Amount of litter movement (describe size and distance expected to travel):** Herbaceous litter exhibits slight movement only associated with water flow patterns.
-
8. **Soil surface (top few mm) resistance to erosion (stability values are averages - most sites will show a range of values):** Soil Stability Index ratings typically 6.0.
-
9. **Soil surface structure and SOM content (include type of structure and A-horizon color and thickness):** Typically an A-horizon of 5 to 20 inches (13-50 cm) with weak to moderate granular, platy, or subangular blocky structure and color hues of 7.5 YR or 10YR, values of 4-5, and a chroma of 1-3. Soil OM typically ranges from 3-6%.
-
10. **Effect of community phase composition (relative proportion of different functional groups) and spatial distribution on infiltration and runoff:** Plant community consists of 60-70% grasses, 20% forbs, and 10-20% shrubs. Dense plant canopy (75-100%) and litter, despite slow to moderate infiltration rates, results in no runoff on this site. Basal cover is typically 10-20% for this site and effectively reduces runoff on this site.
-
11. **Presence and thickness of compaction layer (usually none; describe soil profile features which may be mistaken for compaction on this site):** No compaction layer exists.
-
12. **Functional/Structural Groups (list in order of descending dominance by above-ground annual-production or live foliar cover using symbols: >>, >, = to indicate much greater than, greater than, and equal to):**
- Dominant: mid-size, cool season bunchgrasses
- Sub-dominant: perennial forbs = perennial shrubs
- Other: rhizomatous grass-likes = tall, cool season bunchgrasses = cool season rhizomatous grasses
- Additional:
-
13. **Amount of plant mortality and decadence (include which functional groups are expected to show mortality or decadence):** Minimal decadence, typically associated with shrub component.
-
14. **Average percent litter cover (%) and depth (in):** Litter ranges from 0-25% of total canopy measurement with total litter (including beneath the plant canopy) from 75-100% expected. Herbaceous litter depth typically ranges from 15-30 mm. Woody litter can be up to a couple inches (4-6cm).
-
15. **Expected annual annual-production (this is TOTAL above-ground annual-production, not just forage annual-production):** English: 3000-4500 lb/ac (3750 lb/ac average); Metric: 3360 - 5040 kg/ha (4200 kg/ha average).

16. **Potential invasive (including noxious) species (native and non-native).** List species which **BOTH** characterize degraded states and have the potential to become a dominant or co-dominant species on the ecological site if their future establishment and growth is not actively controlled by management interventions. Species that become dominant for only one to several years (e.g., short-term response to drought or wildfire) are not invasive plants. Note that unlike other indicators, we are describing what is **NOT** expected in the reference state for the ecological site: Bare ground greater than 15% and presence of noxious weeds or Kentucky bluegrass are the most common indicators of a threshold being crossed. Baltic rush, slim sedge, herbaceous cinquefoil, Rocky Mountain iris and willows are common increasers. Kentucky bluegrass, common dandelion, and Canada thistle are common invasive species.

17. **Perennial plant reproductive capability:** All species are capable of reproducing, except in drought years.
