

## **Ecological site EX043B23C172 Stony Upland (StU) Absaroka Subalpine Zone**

Last updated: 10/04/2019  
Accessed: 05/01/2024

---

### **General information**

**Provisional.** A provisional ecological site description has undergone quality control and quality assurance review. It contains a working state and transition model and enough information to identify the ecological site.

### **MLRA notes**

Major Land Resource Area (MLRA): 043B–Central Rocky Mountains

Major Land Resource Unit (MLRA) 43B: Central Rocky Mountains

43B – Central Rocky Mountains – The Central Rocky Mountains extends from northern Montana to southern extent of Wyoming and from Idaho to central Wyoming. The southern extent of 43B is comprised of a combination of metamorphic, igneous, and sedimentary mountains and foothills. Climatic changes across this extent are broad and create several unique breaks in the landscape.

Further information regarding MLRAs, refer to: United States Department of Agriculture, Natural Resources Conservation Service. 2006. Land Resource Regions and Major Land Resource Areas of the United States, the Caribbean, and the Pacific Basin. U.S. Department of Agriculture Handbook 296.  
Available electronically at: [http://www.nrcs.usda.gov/wps/portal/nrcs/detail/soils/ref/?cid=nrcs142p2\\_053624#handbook](http://www.nrcs.usda.gov/wps/portal/nrcs/detail/soils/ref/?cid=nrcs142p2_053624#handbook).

### **LRU notes**

Land Resource Unit (LRU) 43B23C: Absaroka Subalpine Zone

Based on the shifts in geology, precipitation patterns and other climatic factors, as well as elevation and vegetation, the Absaroka Range was divided into LRU 23. Further division of this LRU is necessary due to the gradient moving from the foothills to the summit, as well as aspect shifts (north/east face versus south/west face). Subset C is the high elevation zone noted for dense timber interspersed with open parks and longer persisting snowpack (within timberline). Precipitation can range from 18 to 20 plus inches and is more noted for the duration of snow cover and shorter growing season. To verify or identify Subset C (the referenced subset for this ecological site), refer to the Wyoming LRU matrix key contained within the Ecological Site Key.

This LRU/Subset occurs on the eastern divide of the Absaroka Range. This LRU starts north of Clark, WY and runs to the Thermopolis, WY area. Once the Absaroka Range merges with the Owl Creek and Wind River Ranges, the climatic patterns and elevational changes shifts the plant community and creates a break in the LRU/Subset.

The extent of soils currently correlated to this ecological site does not fit within the digitized boundary. Many of the noted soils are provisional and will be reviewed and corrected in mapping update projects. Other map units are correlated as small inclusions within other MLRA's/LRU's based on elevation, landform, and biological references.

Moisture Regime: Typic Ustic

Temperature Regime: Cryic

Dominant Cover: Rangeland – Sagebrush Steppe (major species is Mountain Big Sagebrush)

Representative Value (RV) Effective Precipitation: 20+ inches (508 mm)

RV Frost-Free Days: 31-65 days

## Classification relationships

Relationship to Other Established Classification Systems:

National Vegetation Classification System (NVC):

2 Shrub & Herb Vegetation Class

2.B Temperate & Boreal Grassland & Shrubland Subclass

2.B.2 Temperate Grassland & Shrubland Formation

2.B.2.Na Western North American Grassland & Shrubland Division

M048 Central Rocky Mountain Montane-Foothill Grassland & Shrubland Macro-group

G273 Central Rocky Mountain Lower Montane, Foothill & Valley Grassland Group

Ecoregions (EPA):

Level I: 6 North Western Forested Mountains

Level II: 6.2 Western Cordillera

Level III: 6.2.10 Middle Rockies

Level IV: 6.2.17ao – Absaroka Volcanic Subalpine Zone

6.2.17i – Absaroka – Gallatin Volcanic Mountains

## Ecological site concept

- Site receives no additional water.
- Slope is <30%
- Soils are:
  - o Textures range from fine sandy loam to clay loam in top 4" (10 cm) of mineral soil surface
  - o All subsurface horizons in the particle size control section have a weighted average of >18% but <35% clay. (The particle size control section is the segment of the profile from either the start of an argillic horizon for 50 cm's or from 25-100 cm's).
  - o Moderately deep to very deep (20-80+ in. (50-200+ cm)
  - o > 5% stone and boulder cover and < 20% cobble and gravel cover
  - o Skeletal ( $\geq 35\%$  rock fragments) within 20" (50 cm) of mineral soil surface
  - o Non-saline, sodic, or saline-sodic

## Associated sites

|             |                                                      |
|-------------|------------------------------------------------------|
| R043BY162WY | <b>Shallow Loamy High Mountains</b><br>Shallow Loamy |
| R043BY170WY | <b>Steep Stony High Mountains</b><br>Steep Stony     |

## Similar sites

|             |                                                                                                                                                        |
|-------------|--------------------------------------------------------------------------------------------------------------------------------------------------------|
| R043BY108WY | <b>Coarse Upland High Mountains</b><br>Coarse Upland (CU) 20+M has higher production, larger coarse fragments (boulders), and different shrub species. |
| R043BY170WY | <b>Steep Stony High Mountains</b><br>Steep Stony (St) 20+M has higher production and different shrub species.                                          |

Table 1. Dominant plant species

|            |                                                                  |
|------------|------------------------------------------------------------------|
| Tree       | Not specified                                                    |
| Shrub      | (1) <i>Artemisia tridentata ssp. vaseyana</i>                    |
| Herbaceous | (1) <i>Pseudoroegneria spicata</i><br>(2) <i>Leucopoa kingii</i> |

## Legacy ID

R043BX772WY

## Physiographic features

This site usually occurs on gentle to steep mountain slopes, valley bottoms, and outwash fans.

**Table 2. Representative physiographic features**

|              |                                                                                                        |
|--------------|--------------------------------------------------------------------------------------------------------|
| Landforms    | (1) Mountain range > Mountain slope<br>(2) Mountain range > Alluvial fan<br>(3) Mountain range > Ridge |
| Runoff class | Negligible to medium                                                                                   |
| Elevation    | 1,981–3,658 m                                                                                          |
| Slope        | 0–30%                                                                                                  |
| Aspect       | Aspect is not a significant factor                                                                     |

## Climatic features

Annual precipitation and modeled relative effective annual precipitation range from 18 to 35 inches (457 – 889 mm). The normal precipitation pattern is evenly distributed through the year and averages over 20 inches. Annual snowfall averages 150 to 200 inches annually. Wide fluctuations may occur in yearly precipitation and result in more dry years than those with more than normal precipitation.

Because of the varied topography, the wind will vary considerably for different parts of the area. Prevailing winds are from the southwest, and strong winds are less frequent than over other areas of Wyoming. Occasional storms, however, can bring brief periods of high winds with gusts exceeding 50 mph.

Temperatures show a wide range between summer and winter and between daily maximums and minimums, due to the high elevation and dry air, which permits rapid incoming and outgoing radiation. Cold air outbreaks from Canada in winter move rapidly from northwest to southeast and account for extreme minimum temperatures. Chinook winds may occur in winter and bring rapid rises in temperature. High winds are generally blocked by high mountains but occur in conjunction with thunderstorms, which are common in late summer. Growth of native cool-season plants begins about June 1, but can be as late as July 15, and continues until the beginning of September.

For detailed information visit the Natural Resources Conservation Service National Water and Climate Center at <http://www.wcc.nrcs.usda.gov/>. Climate station representative of this precipitation zone include: “Cooke City 2W” and “Tower Falls”. The following graphs and charts are a collective sample representing the averaged normals and 30-year annual rainfall data for the selected weather stations from 1981 to 2010.

**Table 3. Representative climatic features**

|                                            |            |
|--------------------------------------------|------------|
| Frost-free period (characteristic range)   | 1-2 days   |
| Freeze-free period (characteristic range)  | 23-47 days |
| Precipitation total (characteristic range) | 457-584 mm |
| Frost-free period (actual range)           | 1-2 days   |
| Freeze-free period (actual range)          | 17-53 days |
| Precipitation total (actual range)         | 432-610 mm |
| Frost-free period (average)                | 2 days     |
| Freeze-free period (average)               | 35 days    |
| Precipitation total (average)              | 533 mm     |

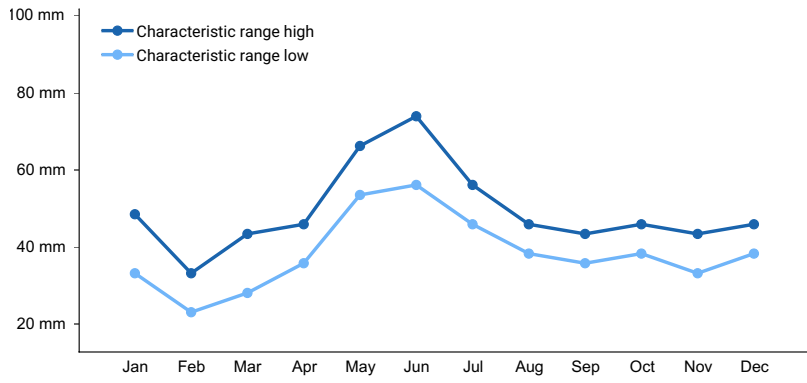

**Figure 1. Monthly precipitation range**

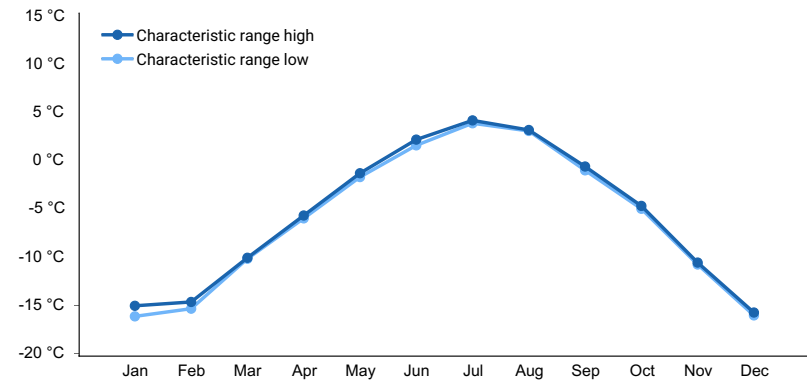

**Figure 2. Monthly minimum temperature range**

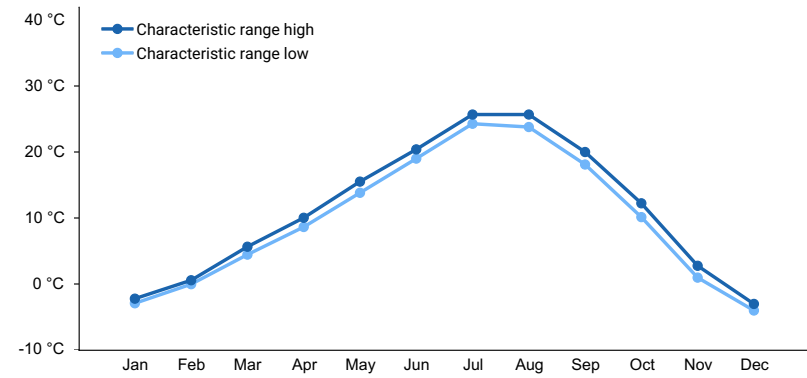

**Figure 3. Monthly maximum temperature range**

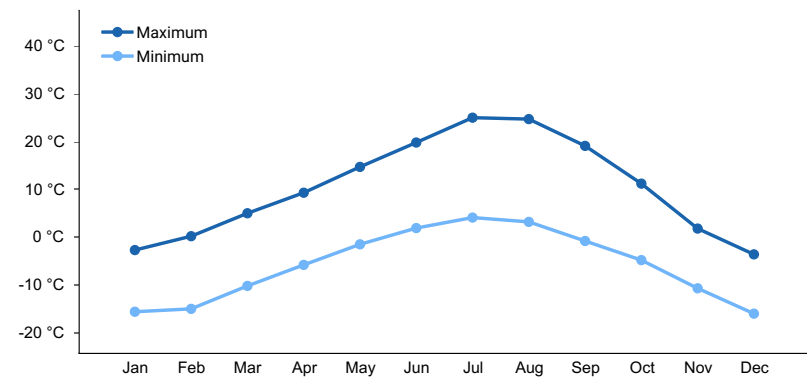

**Figure 4. Monthly average minimum and maximum temperature**

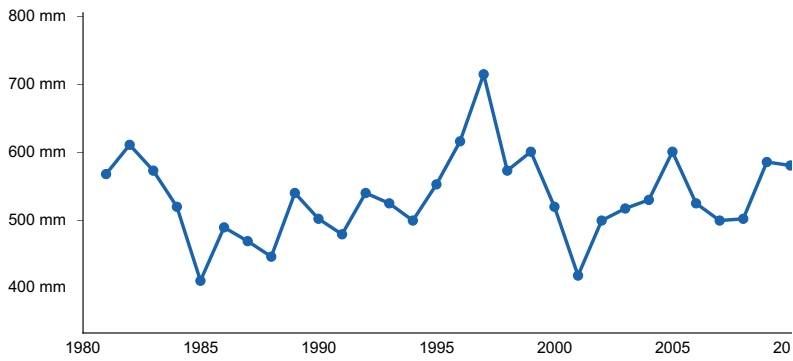

Figure 5. Annual precipitation pattern

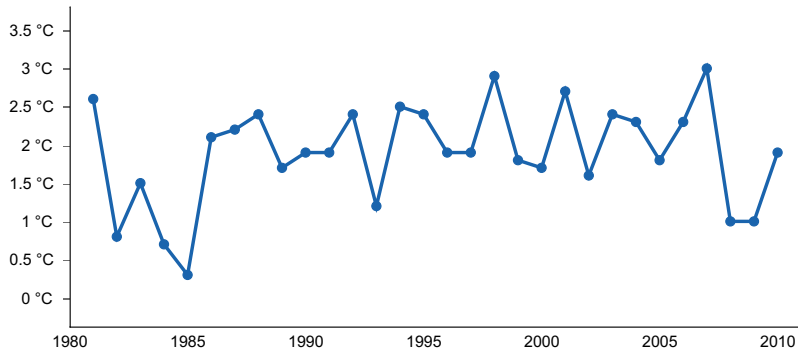

Figure 6. Annual average temperature pattern

### Climate stations used

- (1) COOKE CITY 2 W [USC00241995], Gardiner, MT
- (2) TOWER FALLS [USC00489025], Yellowstone National Park, WY

### Influencing water features

The characteristics of these upland soils have no influence from ground water (water table below 60 inches (150 cm)) and have minimal influence from surface water/overland flow. There may be isolated features that are affected by snow pack that persists longer than surrounding areas due to position on the landform (shaded/protected pockets).

### Soil features

The soils of this site are moderately deep to deep (greater than 20" to bedrock), well-drained, and stony and/or bouldery. Coarse fragments are greater than 35 percent, by volume, within the first 20 inches of soil, usually increasing with depth. Roots penetrate the soil material to at least 20 inches in most places.

Table 4. Representative soil features

|                             |                                                                         |
|-----------------------------|-------------------------------------------------------------------------|
| Parent material             | (1) Alluvium—igneous, metamorphic and sedimentary rock<br>(2) Colluvium |
| Surface texture             | (1) Gravelly, cobbly, stony loam                                        |
| Family particle size        | (1) Fine-loamy<br>(2) Loamy-skeletal                                    |
| Drainage class              | Well drained to somewhat excessively drained                            |
| Permeability class          | Moderately slow to moderately rapid                                     |
| Soil depth                  | 51–152 cm                                                               |
| Surface fragment cover <=3" | 0–20%                                                                   |

|                                                          |               |
|----------------------------------------------------------|---------------|
| Surface fragment cover >3"                               | 0–5%          |
| Available water capacity<br>(0-101.6cm)                  | 5.08–10.16 cm |
| Calcium carbonate equivalent<br>(0-101.6cm)              | 0–15%         |
| Electrical conductivity<br>(0-101.6cm)                   | 0–4 mmhos/cm  |
| Sodium adsorption ratio<br>(0-101.6cm)                   | 0             |
| Soil reaction (1:1 water)<br>(0-101.6cm)                 | 6.6–8.4       |
| Subsurface fragment volume <=3"<br>(Depth not specified) | 10–30%        |
| Subsurface fragment volume >3"<br>(Depth not specified)  | 0–15%         |

## Ecological dynamics

As this site deteriorates, species such as rhizomatous wheatgrass, timber oatgrass, and low sagebrush will increase. Bluebunch wheatgrass, spike fescue, and bitterbrush will decrease in frequency and production. This site has relatively low productivity potential, and is not well suited to grazing improvement practices unless treated as part of a larger unit containing more productive areas.

The Historic Climax Plant Community (description follows the plant community diagram) has been determined by study of rangeland relic areas, or areas protected from excessive disturbance. Trends in plant communities going from heavily grazed areas to lightly grazed areas, seasonal use pastures, and historical accounts have also been used.

The following is a State and Transition Model Diagram that illustrates the common plant communities (states) that can occur on the site and the transitions between these communities. The ecological processes will be discussed in more detail in the plant community narratives following the diagram.

## State and transition model

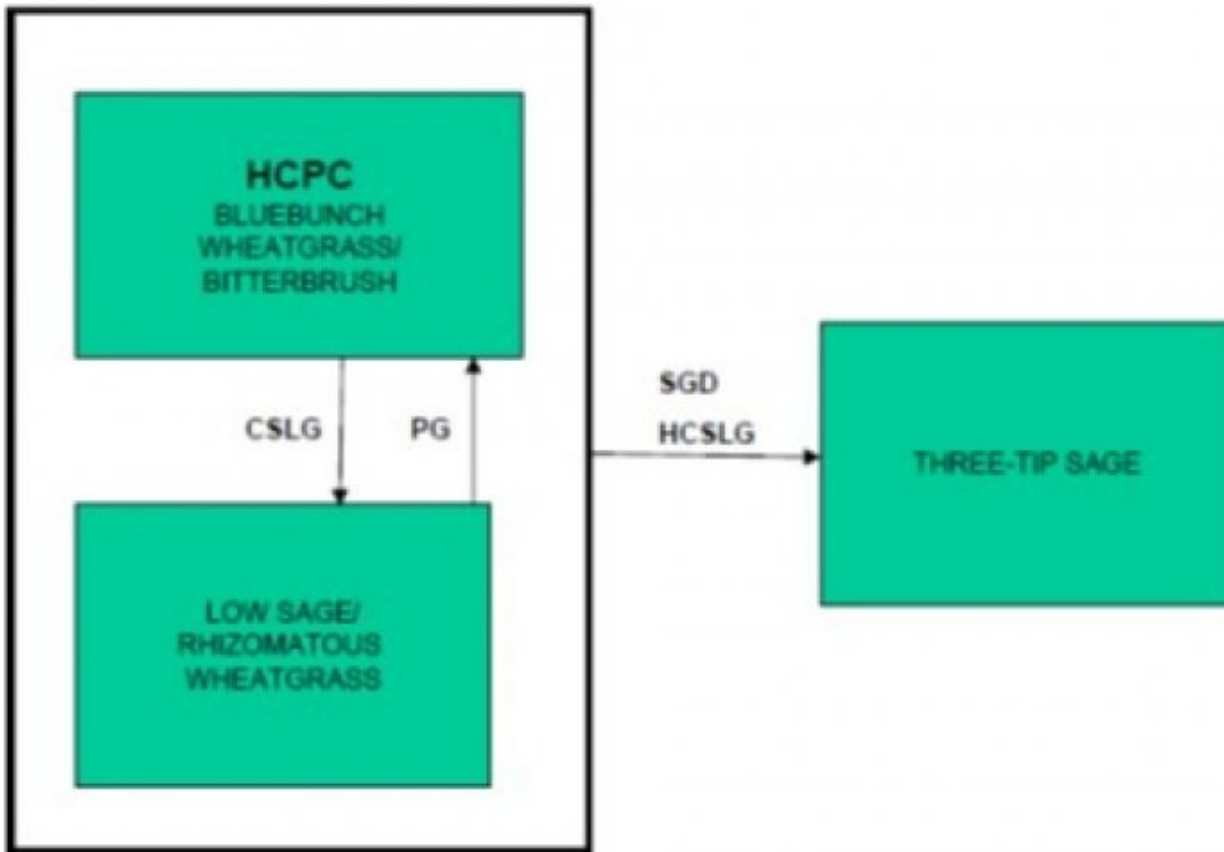

BMA – Brush Management (all methods)  
 BMC – Brush Management (chemical)  
 BMF – Brush Management (fire)  
 BMM – Brush Management (mechanical)  
 CSP – Chemical Seedbed Preparation  
 CSLG – Continuous Season-long Grazing  
 DR – Drainage  
 CSG – Continuous Spring Grazing  
 HB – Heavy Browse  
 HCSLG – Heavy Continuous Season-long Grazing  
 HI – Heavy Inundation  
 LPG – Long-term Prescribed Grazing  
 MT – Mechanical Treatment (chiseling, ripping, pitting)

NF – No Fire  
 NS – Natural Succession  
 NWC – Noxious Weed Control  
 NWI – Noxious Weed Invasion  
 NU – Nonuse  
 P&C – Plow & Crop (including hay)  
 PG – Prescribed Grazing  
 RPT – Re-plant Trees  
 RS – Re-seed  
 SGD – Severe Ground Disturbance  
 SHC – Severe Hoof Compaction  
 WD – Wildlife Damage (Beaver)  
 WF – Wildfire

## Bluebunch Wheatgrass/Bitterbrush Plant Community (HCPC)

### Community 1.1

#### Bluebunch Wheatgrass/Bitterbrush Plant Community (HCPC)

The interpretive plant community for this site is the Historic Climax Plant Community. Potential vegetation is estimated at 55% grasses or grass-like plants, 10% forbs, and 35% woody plants. The major grasses include bluebunch wheatgrass, spike fescue, and Idaho fescue. Other grasses include big, Canby, and mutton bluegrass, prairie junegrass, Letterman, western, and Columbia needlegrass, thickspike and slender wheatgrass, mountain muhly, one-spike and timber oatgrass, bottlebrush squirreltail, spike trisetum, oniongrass, and bentgrass. The major woody plants are bitterbrush and low sagebrush. Other woody plants may include mountain big and three-tip sagebrush and snowberry. A typical plant composition for this state consists of bluebunch wheatgrass 25-35%, spike fescue 15-25%, Idaho fescue 5-10%, other grasses and grass-like plants 10-20%, perennial forbs 5-10%, bitterbrush 5-10%, low sagebrush 5-10%, and 5-15% other woody plants. Ground cover, by ocular estimate, varies from 35-40%. The total annual production (air-dry weight) of this state is about 1000 pounds per acre, but it can range from about 750 lbs./acre in unfavorable years to about 1200 lbs./acre in above average years. The following is the growth curve of this plant community expected during a normal year: Growth curve number: WY0101 Growth curve name: 20+M, UPLAND SITES Growth curve description: ALL UPLAND SITES JAN FEB MAR APR MAY JUN JUL AUG SEP OCT NOV DEC 0 0 0 0 5 30 40 20 5 0 0 0 (Monthly percentages of total annual growth) The state is stable and well adapted to the Central Rocky Mountains climatic conditions. The diversity in plant species allows for high drought resistance. This is a sustainable plant community (site/soil stability, watershed function, and biologic integrity) Transitions or pathways leading to other plant communities are as follows: • Severe Ground Disturbance with Heavy, Continuous Season-long Grazing will convert this plant community to the Three-tip Sage State. • Continuous Season-long Grazing will convert the plant community to the Low Sage/Rhizomatous Wheatgrass State.

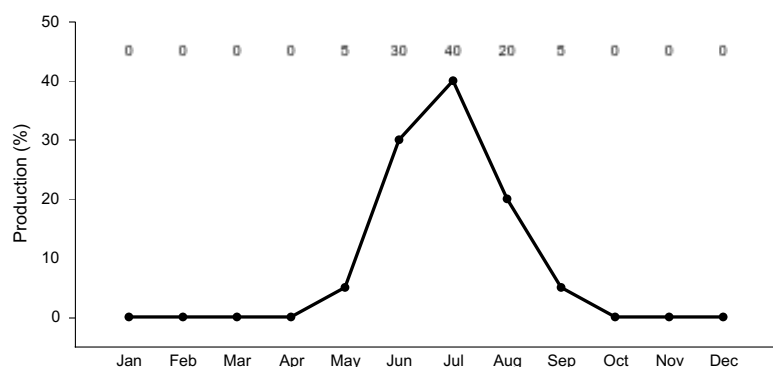

Figure 8. Plant community growth curve (percent production by month). WY0101, 20+ upland sites.

## State 2

### Low Sage/Rhizomatous Wheatgrass Plant Community

#### Community 2.1

##### Low Sage/Rhizomatous Wheatgrass Plant Community

This plant community is a result of improper grazing management practices. The stand is composed of almost entirely low sage and rhizomatous wheatgrass with such forbs as phlox and goldenweed present as well. This state is commonly found on exposed, windswept ridges that are subject to harsh climatic conditions as well as severe winter use due to their exposed nature. The total annual production (air-dry weight) of this state is about 750 pounds per acre, but it can range from about 500 lbs./acre in unfavorable years to about 1000 lbs./acre in above average years. The following is the growth curve of this plant community expected during a normal year: Growth curve number: WY0101 Growth curve name: 20+M, UPLAND SITES Growth curve description: ALL UPLAND SITES JAN FEB MAR APR MAY JUN JUL AUG SEP OCT NOV DEC 0 0 0 0 5 30 40 20 5 0 0 0 (Monthly percentages of total annual growth) The state is stable and protected from excessive erosion. The biotic integrity of this plant community is usually intact, however forage value will decrease and wildlife values will shift toward different species. The watershed is functioning. Transitional pathways leading to other plant communities are as follows: • Severe Ground Disturbance followed by Heavy, Continuous Season-long Grazing will convert this plant community to the Three-tip



Sage State. • Prescribed Grazing will return this state to near Historic Climax Plant Community (Bluebunch Wheatgrass/Bitterbrush State).

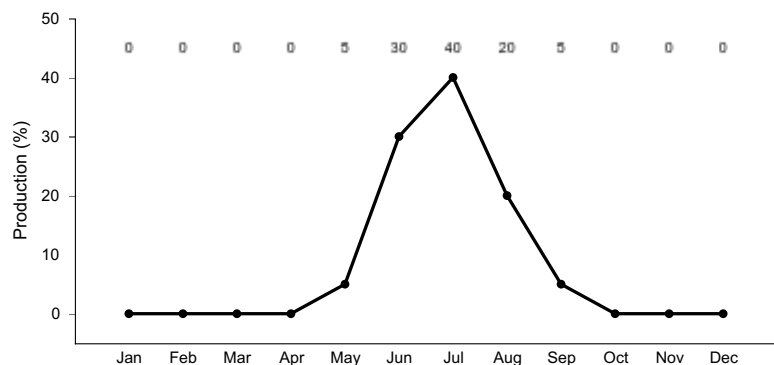

Figure 9. Plant community growth curve (percent production by month). WY0101, 20+ upland sites.

### State 3 Three-tip Sage Plant Community

#### Community 3.1 Three-tip Sage Plant Community

This plant community is the result of wildfire or severe ground disturbance followed by improper grazing management practices. Dominant species include rabbitbrush and three-tip sagebrush. The total annual production (air-dry weight) of this state is about 500 pounds per acre, but it can range from about 200 lbs./acre in unfavorable years to about 800 lbs./acre in above average years. The following is the growth curve of this plant community expected during a normal year: Growth curve number: WY0101 Growth curve name: 20+M, UPLAND SITES Growth curve description: ALL UPLAND SITES JAN FEB MAR APR MAY JUN JUL AUG SEP OCT NOV DEC 0 0 0 0 5 30 40 20 5 0 0 0 (Monthly percentages of total annual growth) The state is unstable and vulnerable to excessive erosion. The biotic integrity of this plant community is at risk depending on how far a shift has occurred in plant composition toward sprouting shrubs and annual forbs. The watershed is usually at risk or nonfunctioning due to an increase in bare ground. Transitional pathways leading to other plant communities are as follows: It is not often practicable or economically feasible to convert this plant community at the present time.

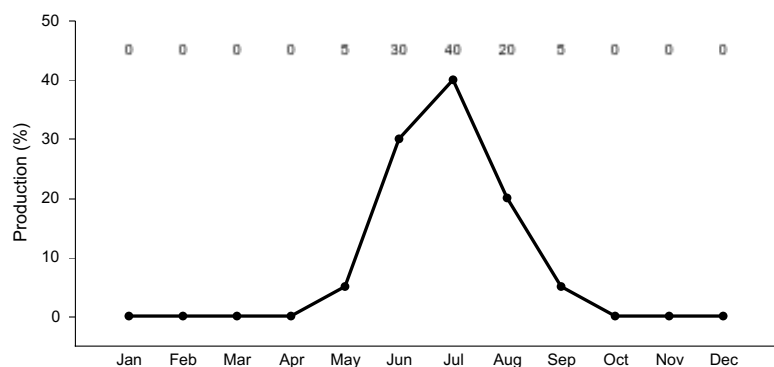

Figure 10. Plant community growth curve (percent production by month). WY0101, 20+ upland sites.

### Additional community tables

Table 5. Community 1.1 plant community composition

| Group                  | Common Name          | Symbol | Scientific Name                | Annual Production (Kg/Hectare) | Foliar Cover (%) |
|------------------------|----------------------|--------|--------------------------------|--------------------------------|------------------|
| <b>Grass/Grasslike</b> |                      |        |                                |                                |                  |
| 1                      |                      |        |                                | 280–392                        |                  |
|                        | bluebunch wheatgrass | PSSP6  | <i>Pseudoroegneria spicata</i> | 280–392                        | –                |
| 2                      |                      |        |                                | 168–280                        |                  |

|             |                         |        |                                            |         |   |
|-------------|-------------------------|--------|--------------------------------------------|---------|---|
|             | spike fescue            | LEKI2  | <i>Leucopoa kingii</i>                     | 168–280 | – |
| 3           |                         |        |                                            | 56–112  |   |
|             | Idaho fescue            | FEID   | <i>Festuca idahoensis</i>                  | 56–112  | – |
| 4           |                         |        |                                            | 112–224 |   |
|             | Grass, perennial        | 2GP    | <i>Grass, perennial</i>                    | 0–56    | – |
|             | Letterman's needlegrass | ACLE9  | <i>Achnatherum lettermanii</i>             | 0–56    | – |
|             | Columbia needlegrass    | ACNE9  | <i>Achnatherum nelsonii</i>                | 0–56    | – |
|             | western needlegrass     | ACOC3  | <i>Achnatherum occidentale</i>             | 0–56    | – |
|             | bentgrass               | AGROS2 | <i>Agrostis</i>                            | 0–56    | – |
|             | timber oatgrass         | DAIN   | <i>Danthonia intermedia</i>                | 0–56    | – |
|             | onespike danthonia      | DAUN   | <i>Danthonia unispicata</i>                | 0–56    | – |
|             | squirreltail            | ELELE  | <i>Elymus elymoides ssp. elymoides</i>     | 0–56    | – |
|             | thickspike wheatgrass   | ELLAL  | <i>Elymus lanceolatus ssp. lanceolatus</i> | 0–56    | – |
|             | slender wheatgrass      | ELTR7  | <i>Elymus trachycaulus</i>                 | 0–56    | – |
|             | prairie Junegrass       | KOMA   | <i>Koeleria macrantha</i>                  | 0–56    | – |
|             | oniongrass              | MEBU   | <i>Melica bulbosa</i>                      | 0–56    | – |
|             | mountain muhly          | MUMO   | <i>Muhlenbergia montana</i>                | 0–56    | – |
|             | muttongrass             | POFE   | <i>Poa fendleriana</i>                     | 0–56    | – |
|             | spike trisetum          | TRSP2  | <i>Trisetum spicatum</i>                   | 0–56    | – |
| <b>Forb</b> |                         |        |                                            |         |   |
| 5           |                         |        |                                            | 56–112  |   |
|             | Forb, perennial         | 2FP    | <i>Forb, perennial</i>                     | 0–56    | – |
|             | common yarrow           | ACMI2  | <i>Achillea millefolium</i>                | 0–56    | – |
|             | agoseris                | AGOSE  | <i>Agoseris</i>                            | 0–56    | – |
|             | pussytoes               | ANTEN  | <i>Antennaria</i>                          | 0–56    | – |
|             | sandwort                | ARENA  | <i>Arenaria</i>                            | 0–56    | – |
|             | milkvetch               | ASTRA  | <i>Astragalus</i>                          | 0–56    | – |
|             | balsamroot              | BALSA  | <i>Balsamorhiza</i>                        | 0–56    | – |
|             | Indian paintbrush       | CASTI2 | <i>Castilleja</i>                          | 0–56    | – |
|             | hawksbeard              | CREPI  | <i>Crepis</i>                              | 0–56    | – |
|             | fleabane                | ERIGE2 | <i>Erigeron</i>                            | 0–56    | – |
|             | buckwheat               | ERIOG  | <i>Eriogonum</i>                           | 0–56    | – |
|             | stoneseed               | LITHO3 | <i>Lithospermum</i>                        | 0–56    | – |
|             | desertparsley           | LOMAT  | <i>Lomatium</i>                            | 0–56    | – |
|             | lupine                  | LUPIN  | <i>Lupinus</i>                             | 0–56    | – |
|             | creeping barberry       | MARE11 | <i>Mahonia repens</i>                      | 0–56    | – |
|             | bluebells               | MERTE  | <i>Mertensia</i>                           | 0–56    | – |
|             | owl's-clover            | ORTHO  | <i>Orthocarpus</i>                         | 0–56    | – |
|             | ragwort                 | PACKE  | <i>Packera</i>                             | 0–56    | – |
|             | phlox                   | PHLOX  | <i>Phlox</i>                               | 0–56    | – |
|             | stonecrop               | SEDUM  | <i>Sedum</i>                               | 0–56    | – |
|             | ragwort                 | SENEC  | <i>Senecio</i>                             | 0–56    | – |

|                   |                        |        |                                           |        |   |
|-------------------|------------------------|--------|-------------------------------------------|--------|---|
|                   | aster                  | SYMPH4 | <i>Symphyotrichum</i>                     | 0-56   | - |
|                   | clover                 | TRIFO  | <i>Trifolium</i>                          | 0-56   | - |
|                   | American vetch         | VIAM   | <i>Vicia americana</i>                    | 0-56   | - |
| <b>Shrub/Vine</b> |                        |        |                                           |        |   |
| 6                 |                        |        |                                           | 56-112 |   |
|                   | antelope bitterbrush   | PUTR2  | <i>Purshia tridentata</i>                 | 56-112 | - |
| 7                 |                        |        |                                           | 56-112 |   |
|                   | little sagebrush       | ARAR8  | <i>Artemisia arbuscula</i>                | 56-112 | - |
| 8                 |                        |        |                                           | 56-168 |   |
|                   | Shrub, deciduous       | 2SD    | <i>Shrub, deciduous</i>                   | 0-56   | - |
|                   | Shrub, evergreen       | 2SE    | <i>Shrub, evergreen</i>                   | 0-56   | - |
|                   | Tree, deciduous        | 2TD    | <i>Tree, deciduous</i>                    | 0-56   | - |
|                   | Tree, evergreen        | 2TE    | <i>Tree, evergreen</i>                    | 0-56   | - |
|                   | threetip sagebrush     | ARTR4  | <i>Artemisia tripartita</i>               | 0-56   | - |
|                   | mountain big sagebrush | ARTRV  | <i>Artemisia tridentata ssp. vaseyana</i> | 0-56   | - |
|                   | snowberry              | SYMPH  | <i>Symphoricarpos</i>                     | 0-56   | - |

## Animal community

### Animal Community – Wildlife Interpretations

Bluebunch Wheatgrass/Bitterbrush Plant Community (HCPC): When blown clear, this plant community provides limited winter forage for large grazers when snow depth prevents foraging on other sites. Otherwise, it is mostly used by wildlife in transit to other habitats.

Low Sage/Rhizomatous Wheatgrass Plant Community: This plant community may be useful for the same wildlife that would use the Historic Climax Plant Community. However, the plant community composition is less diverse, and thus, less apt to meet the seasonal needs of these animals.

Three-tip Sage Plant Community: This plant community exhibits a low level of plant species diversity. In most cases, it is not a desirable plant community to select as a wildlife habitat management objective.

### Animal Community – Grazing Interpretations

The following table lists suggested stocking rates for cattle under continuous season-long grazing under normal growing conditions. These are conservative estimates that should be used only as guidelines in the initial stages of the conservation planning process. Often, the current plant composition does not entirely match any particular plant community (as described in this ecological site description). Because of this, a field visit is recommended, in all cases, to document plant composition and production. More precise carrying capacity estimates should eventually be calculated using this information along with animal preference data, particularly when grazers other than cattle are involved. Under more intensive grazing management, improved harvest efficiencies can result in an increased carrying capacity. If distribution problems occur, stocking rates must be reduced to maintain plant health and vigor.

Plant Community Production Carrying Capacity\*  
(lb./ac) (AUM/ac)

Bluebunch Wheatgrass/Bitterbrush (HCPC) 750-1200 0.3

Low Sage/Rhizomatous Wheatgrass 500-1000 0.2

Three-tip Sage 200-800 0.1

\* - Continuous, season-long grazing by cattle under average growing conditions.

Grazing by domestic livestock is one of the major income-producing industries in the area. Rangeland in this area

may provide yearlong forage for cattle, sheep, or horses. During the dormant period, the forage for livestock use needs to be supplemented with protein because the quality does not meet minimum livestock requirements.

## **Hydrological functions**

Water is the principal factor limiting forage production on this site. This site is dominated by soils in hydrologic group B and C, with localized areas in hydrologic group D. Infiltration ranges from moderately slow to moderate. Runoff potential for this site varies from low to moderate depending on soil hydrologic group and ground cover (refer to Part 630, NRCS National Engineering Handbook for detailed hydrology information).

Rills and gullies should not typically be present. Water flow patterns should be barely distinguishable if at all present. Pedestals are only slightly present in association with bunchgrasses. Litter typically falls in place, and signs of movement are not common. Chemical and physical crusts are rare to non-existent. Cryptogamic crusts are present, but only cover 1-2% of the soil surface.

## **Recreational uses**

This site provides hunting opportunities for upland game species.

## **Wood products**

No appreciable wood products are present on the site.

## **Inventory data references**

Information presented here has been derived from NRCS clipping data and other inventory data. Field observations from range trained personnel were also used. Those involved in developing this site include: Bill Christensen, Range Management Specialist, NRCS; Karen Clause, Range Management Specialist, NRCS; and Everet Bainter, Range Management Specialist, NRCS. Other sources used as references include USDA NRCS Water and Climate Center, USDA NRCS National Range and Pasture Handbook, USDI and USDA Interpreting Indicators of Rangeland Health Version 3, and USDA NRCS Soil Surveys from various counties.

Information presented here has been derived from NRCS inventory data, Field observations from range trained personnel, and the existing range site descriptions. Those involved in developing the Loamy range site include: Karen Clause, Range Management Specialist, NRCS and Everet Bainter, Range Management Specialist.

Those involved in the development of the new concept for Loamy and Loamy Calcareous Ecological site include: Ray Gullion, Area Range Management Specialist, NRCS; Jim Wolf, Resource Manager, USDI-BLM; Jack Mononi, Range Management Specialist, USDI-BLM; Daniel Wood, MLRA Soil Survey Leader, NRCS; Jane Karinen, Soil Data Quality Specialist, NRCS; and Marji Patz, Ecological Site Specialist, NRCS.

### **Inventory Data References:**

Ocular field estimations observed by trained personnel were completed at each site. Then sites were selected where a 100-foot tape was stretched, and the following sample procedures were completed by inventory staff. For full sampling protocol and guidelines with forms please refer to the Wyoming ESI Operating Procedures, compiled in 2012 for the Powell and Rock Springs Soil Survey Office, USDA-NRCS.

- Double Sampling Production Data (4.8 square foot hoop used to estimate 10 points, clipped a minimum of 2 of these estimated points, with two 21-foot X 21-foot square extended shrub plots).
- Line Point Intercept (over story and understory captured with soil cover). Height of herbaceous and woody cover is collected every three feet along established transect.)
- Continuous Line Intercept (Woody Canopy Cover, with minimum gap of 0.2 of a foot for all woody species and succulents. Intercept height collected at each measurement.),
- Gap Intercept (Basal Gap measured with a minimum gap requirement of 0.7 foot.),
- Sample Point (10 – 1-meter square point photographs taken at set distances on transect. Red using the sample point computer program established by the High Plains Agricultural Research Center, WY).
- Soil Stability (Slake Test – surface and subsurface samples collected and processed according to the soil stability guidelines provided by the Jornada Research Center, NM.)

## Other references

Baker, William L. 2006. Fire and Restoration of Sagebrush Ecosystems. *Wildlife Society Bulletin* 34(1): 177-185.

Bestelmeyer, B., and J. R. Brown. 2005. State-and-transition models 101: a fresh look at vegetation change. *The Quivira Coalition Newsletter*, Vol. 7, No. 3.

Bestelmeyer, B., J. R. Brown, K. M. Havstad, B. Alexander, G. Chavez, J. E. Herrick. 2003. Development and use of state and transition models for rangelands. *Journal of Range Management* 56(2):114-126.

Bestelmeyer, B., J. E. Herrick, J. R. Brown, D. A. Trujillo, and K. M. Havstad. 2004. Land management in the American Southwest: a state-and-transition approach to ecosystem complexity. *Environmental Management* 34(1):38-51.

Herrick, J. E., J. W. Van Zee, K. M. Havstad, L. M. Burkett, and W. G. Whitford. 2005. Monitoring manual for grassland, shrubland and savanna Ecosystems. Volume I Quick Start. USDA - ARS Jornada Experimental Range, Las Cruces, New Mexico.

Herrick, J. E., J. W. Van Zee, K. M. Havstad, L. M. Burkett, and W. G. Whitford. 2005. Monitoring manual for grassland, shrubland and savanna Ecosystems. Volume II: Design, supplementary methods and interpretation. USDA - ARS Jornada Experimental Range, Las Cruces, New Mexico.

NRCS. 2014. (electronic) National Water and Climate Center. Available online at <http://www.wcc.nrcs.usda.gov/>

NRCS. 2014. (electronic) Field Office Technical Guide. Available online at [http://efotg.nrcs.usda.gov/efotg\\_locator.aspx?map=WY](http://efotg.nrcs.usda.gov/efotg_locator.aspx?map=WY) NRCS. 2009. Plant Guide: Cheatgrass. Prepared by Skinner et al., National Plant Data Center.

Pellant, M., P. Shaver, D. A. Pyke, and J. E. Herrick. 2005. Interpreting indicators of rangeland health. Version 4. Technical Reference 1734-6.

USDI-BLM. Ricketts, M. J., R. S. Noggles, and B. Landgraf-Gibbons. 2004. Pryor Mountain Wild Horse Range Survey and Assessment. USDA-Natural Resources Conservation Service.

Schoeneberger, P. J., D. A. Wysocki, E. C. Benham, and Soil Survey Staff. 2012. Field book for describing and sampling soils, Version 3.0. Natural Resources Conservation Service, National Soil Survey Center, Lincoln, NE. (<http://soils.usda.gov/technical/fieldbook/>)

Stringham, T. K. and W. C. Krueger. 2001. States, transitions, and thresholds: Further refinement for rangeland applications. Agricultural Experiment Station, Oregon State University. Special Report 1024.

Stringham, T. K., W. C. Kreuger, and P. L. Shaver. 2003. State and transition modeling: an ecological process approach. *Journal of Range Management* 56(2):106-113.

United States Department of Agriculture. Soil Survey Division Staff. 1993. Soil Survey Manual, United States Department of Agriculture Handbook No. 18, Chapter 3: Examination and Description of Soils. Pg.192-196.

USDA, NRCS. 1997. National Range and Pasture Handbook. (<http://www.glti.nrcs.usda.gov/technical/publications/nrph.html>)

Trlica, M. J. 1999. Grass growth and response to grazing. Colorado State University. Cooperative Extension. Range. Natural Resource Series. No. 6.108.

U.S. Department of Agriculture, Natural Resources Conservation Service (USDA/NRCS). 2007. The PLANTS Database (<http://plants.usda.gov>). National Plant Data Center, Baton Rouge, LA 70874-4490 USA.

U.S. Department of Agriculture, Natural Resources Conservation Service (USDA/NRCS), Soil Survey Staff. 2010. Keys to Soil Taxonomy, Eleventh Edition, 2010.

USDA/NRCS Soil survey manuals for appropriate counties within MLRA 43B.

Western Regional Climate Center. (2014) (electronic) Station Metadata. Available online at: <http://www.wrcc.dri.edu/summary/climsmwy.html>.

## Contributors

K. Clause

## Approval

Scott Woodall, 10/04/2019

## Rangeland health reference sheet

Interpreting Indicators of Rangeland Health is a qualitative assessment protocol used to determine ecosystem condition based on benchmark characteristics described in the Reference Sheet. A suite of 17 (or more) indicators are typically considered in an assessment. The ecological site(s) representative of an assessment location must be known prior to applying the protocol and must be verified based on soils and climate. Current plant community cannot be used to identify the ecological site.

|                                             |                                          |
|---------------------------------------------|------------------------------------------|
| Author(s)/participant(s)                    | K. Clause, E. Bainter                    |
| Contact for lead author                     | karen.clause@wy.usda.gov or 307-367-2257 |
| Date                                        | 03/16/2007                               |
| Approved by                                 | E. Bainter                               |
| Approval date                               |                                          |
| Composition (Indicators 10 and 12) based on | Annual Production                        |

## Indicators

1. **Number and extent of rills:** Rare to nonexistent. Where present, short and widely spaced.
- 

2. **Presence of water flow patterns:** Barely observable.
- 

3. **Number and height of erosional pedestals or terracettes:** Rare to nonexistent.
- 

4. **Bare ground from Ecological Site Description or other studies (rock, litter, lichen, moss, plant canopy are not bare ground):** Bare ground can range from 0-25%.
- 

5. **Number of gullies and erosion associated with gullies:** Active gullies should not be present.
- 

6. **Extent of wind scoured, blowouts and/or depositional areas:** Rare to nonexistent.
-

7. **Amount of litter movement (describe size and distance expected to travel):** Herbaceous and large woody litter not expected to move.
- 
8. **Soil surface (top few mm) resistance to erosion (stability values are averages - most sites will show a range of values):** Soil Stability Index ratings range from 2 (interspaces) to 6 (under plant canopy), but average values should be 3.5 or greater.
- 
9. **Soil surface structure and SOM content (include type of structure and A-horizon color and thickness):** Soil data is limited for this site. Soil OM of 4-16% is expected.
- 
10. **Effect of community phase composition (relative proportion of different functional groups) and spatial distribution on infiltration and runoff:** Plant community consists of 55-80% grasses, 10% forbs, and 10-35% shrubs. Evenly distributed plant canopy (50-75%) and litter plus moderate infiltration rates result in minimal runoff. Basal cover is typically less than 15% and marginally affects runoff on this site. Surface rock fragments of 20-50% provide stability to the site, but reduce infiltration.
- 
11. **Presence and thickness of compaction layer (usually none; describe soil profile features which may be mistaken for compaction on this site):** None.
- 
12. **Functional/Structural Groups (list in order of descending dominance by above-ground annual-production or live foliar cover using symbols: >>, >, = to indicate much greater than, greater than, and equal to):**
- Dominant: Mid-size, cool season bunchgrasses
- Sub-dominant: perennial shrubs perennial forbs
- Other: cool season rhizomatous grasses=short cool season bunchgrasses
- Additional:
- 
13. **Amount of plant mortality and decadence (include which functional groups are expected to show mortality or decadence):** Minimal decadence, typically associated with shrub component.
- 
14. **Average percent litter cover (%) and depth ( in):** Litter ranges from 15-20% of total canopy measurement with total litter (including beneath the plant canopy) from 40-60% expected. Herbaceous litter depth typically ranges from 3-10mm. Woody litter can be up to a couple inches (4-6 cm).
- 
15. **Expected annual annual-production (this is TOTAL above-ground annual-production, not just forage annual-production):** English: 750-1200 lb/ac (1000 lb/ac average); Metric 840-1344 kg/ha (1120 kg/ha average).
- 
16. **Potential invasive (including noxious) species (native and non-native). List species which BOTH characterize**

degraded states and have the potential to become a dominant or co-dominant species on the ecological site if their future establishment and growth is not actively controlled by management interventions. Species that become dominant for only one to several years (e.g., short-term response to drought or wildfire) are not invasive plants. Note that unlike other indicators, we are describing what is NOT expected in the reference state for the ecological site: Bare ground greater than 40% is the most common indicator of a threshold being crossed. Rabbitbrush, Sandberg bluegrass, buckwheat, yarrow, and phlox are common increasers. Annual weeds such as cheatgrass and mustards are common invasive species in disturbed sites.

---

17. **Perennial plant reproductive capability:** All species are capable of reproducing, except in extreme drought years.
-