

Ecological site F043BP710WY Upland Cool Woodland Group

Last updated: 3/01/2024
Accessed: 05/17/2024

General information

Provisional. A provisional ecological site description has undergone quality control and quality assurance review. It contains a working state and transition model and enough information to identify the ecological site.

MLRA notes

Major Land Resource Area (MLRA): 043B–Central Rocky Mountains

043B – Central Rocky Mountains – This MLRA is extensive including Montana, Idaho, Wyoming and a small portion in Utah. This MLRA consists of the major chains of Mountain Ranges with the corresponding valleys. Cartographic standards limited the ability to capture the foothills as a separate MLRA, so revisions of the MLRA boundaries in 2006 led to the inclusion of the foothills with the mountains for much of Wyoming.

Further information regarding MLRAs, refer to: United States Department of Agriculture, Natural Resources Conservation Service. 2006. Land Resource Regions and Major Land Resource Areas of the United States, the Caribbean, and the Pacific Basin. U.S. Department of Agriculture Handbook 296. Available electronically at: http://www.nrcs.usda.gov/wps/portal/nrcs/detail/soils/ref/?cid=nrcs142p2_053624#handbook.

LRU notes

LRU P: PES (Provisional Ecological Site or Group - PEG) A PROVISIONAL ECOLOGICAL SITE is a conceptual grouping of soil map unit components within a Major Land Resource Area (MLRA) based on the similarities in response to management. Although there may be wide variability in the productivity of the soils grouped into a Provisional Site, the soil vegetation interactions as expressed in the State and Transition Model are similar and the management actions required to achieve objectives, whether maintaining the existing ecological state or managing for an alternative state, are similar. Provisional Sites are likely to be refined into more precise concept during the process of meeting the APPROVED ECOLOGICAL SITE DESCRIPTION criteria.

This PROVISIONAL ECOLOGICAL SITE has been developed to meet the standards established in the National Ecological Site Handbook. The information associated with this ecological site does not meet the Approved Ecological Site Description Standard, but it has been through a Quality Control and Quality Assurance processes to assure consistency and completeness. Further investigations, reviews and correlations are necessary before it becomes an Approved Ecological Site Description.

Classification relationships

PSME/ACGL habitat type (Steele Et.Al. 1983)

Ecological site concept

- Site does not receive any additional water
- Soils are
 - o Generally not saline or saline-sodic
 - o Moderately deep, deep, or very deep

- o Typically less than 5% stone and boulder on surface (<15%)
- o Soil surface texture ranges from sandy loam to clay loam in surface mineral 4"
- o Duff layer is common

Associated sites

F043BP708WY	Upland Aspen Woodland Group Upland Aspen Woodlands are common on the lower edge of Upland Cool Woodlands, especially in areas with snow catch/runoff.
F043BP707WY	Subirrigated Cool Woodland Group Subirrigated Cool Woodlands can be found in areas with snow melt catch, or seeps on the lower fringes of or in depressions within the Upland Cool Woodlands.
F043BP702WY	Shallow Cool Woodland Group Shallow Cool Woodlands will occur on the transition from rock outcrop to the deeper soils of the Upland Cool Woodlands.

Similar sites

F043BP709WY	Upland Cold Woodland Group Upland Cold Woodlands are similar in concept, with a shift in timber species.
R043BY308WY	Coarse Upland (CU) 15-19" Foothills and Mountains East Precipitation Zone Course Upland 15-19" Foothills and Basins East has similar soils, but is the rangeland composition of this site. No timber is seen within this community.
R043BY208WY	Coarse Upland Foothills and Mountains West Course Upland 15-19" Foothills and Basins West has similar soils, but is the rangeland composition of this site. No timber is seen within this community.
R043BY322WY	Loamy (Ly) 15-19" Foothills and Mountains East Precipitation Zone Loamy 15-19" Foothills and Mountains East has similar soils, but is the rangeland composition of this site. No timber is seen within this community.
F043BP711WY	Upland Warm Woodland Group Upland Warm Woodlands are similar in concept, with a shift in timber species.
R043BY222WY	Loamy Foothills and Mountains West Loamy 15-19" Foothills and Mountains West has similar soils, but is the rangeland composition of this site. No timber is seen within this community.

Table 1. Dominant plant species

Tree	(1) <i>Pseudotsuga menziesii</i> (2) <i>Picea engelmannii</i>
Shrub	(1) <i>Spiraea betulifolia</i> (2) <i>Vaccinium membranaceum</i>
Herbaceous	(1) <i>Calamagrostis rubescens</i> (2) <i>Carex rossii</i>

Physiographic features

This site occurs on most slopes, especially in pockets or concave areas within landslides and other deposits. Average slope is less than 25 percent.

Table 2. Representative physiographic features

Landforms	(1) Mountains > Mountain slope (2) Mountains > Moraine (3) Mountains > Landslide
Runoff class	Negligible to high
Elevation	1,829–2,896 m

Slope	0–60%
Aspect	NW, N, NE, E

Climatic features

Annual precipitation ranges from 15-19 inches per year. June is generally the wettest month. July, August, and September are somewhat less with daily amounts rarely exceeding one inch. Wide fluctuations may occur in yearly precipitation and result in more dry years than those with more than normal precipitation.

Temperatures show a wide range between summer and winter and between daily maximums and minimums. This is predominantly due to the high elevation and dry air, which permits rapid incoming and outgoing radiation. Cold air outbreaks in winter move rapidly from northwest to southeast and account for extreme minimum temperatures.

Snowfall is quite heavy in the area. Annual snowfall averages about 150 inches. Extreme storms may occur during the winter, but most severely affect ranch operations during late winter and spring. Prevailing winds are from the southwest, because of the varied topography, the wind will vary considerably for different parts of the area. The wind is usually much lighter at the lower elevations and in the valleys as compared with the higher terrain. Occasional storms, however, can bring brief periods of high winds with gusts exceeding 50 mph. Growth of native cool season plants begins about May 15 and continues to about September 15.

The following information is from the "Jackson", "Cooke City 2W", and "Burgess Junction" climate stations, at the lower end of this precipitation zone. Climate Data is limited and is being extrapolated from the nearest stations.

Table 3. Representative climatic features

Frost-free period (characteristic range)	4-7 days
Freeze-free period (characteristic range)	42-52 days
Precipitation total (characteristic range)	457-584 mm
Frost-free period (actual range)	3-7 days
Freeze-free period (actual range)	39-54 days
Precipitation total (actual range)	432-610 mm
Frost-free period (average)	5 days
Freeze-free period (average)	47 days
Precipitation total (average)	533 mm

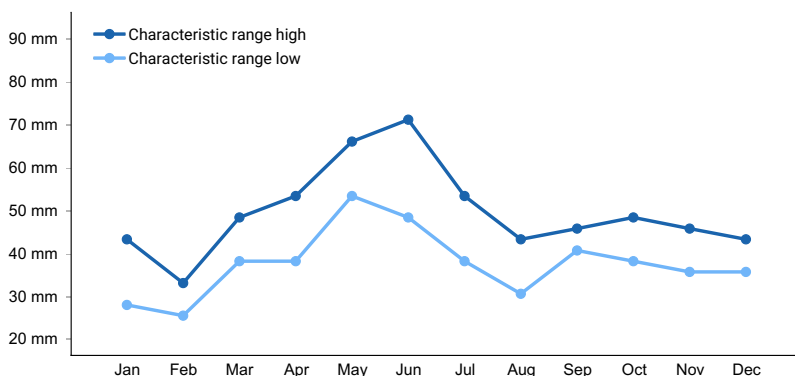

Figure 1. Monthly precipitation range

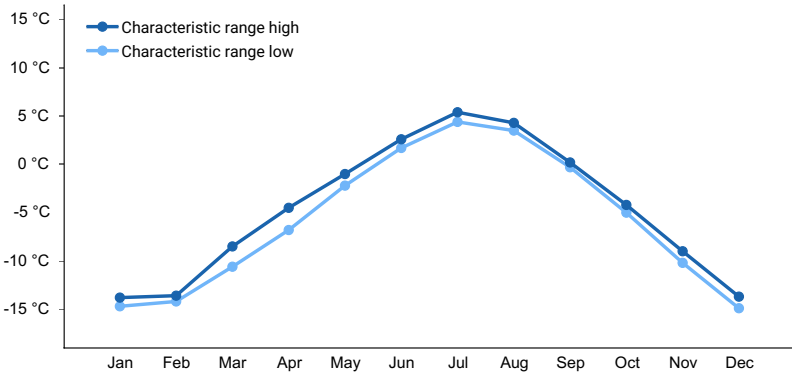

Figure 2. Monthly minimum temperature range

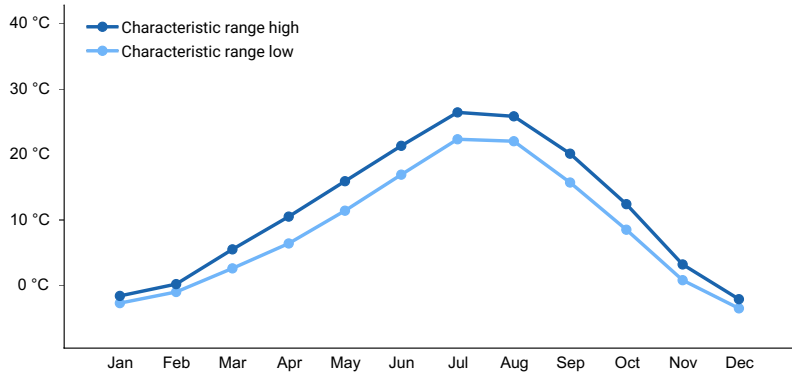

Figure 3. Monthly maximum temperature range

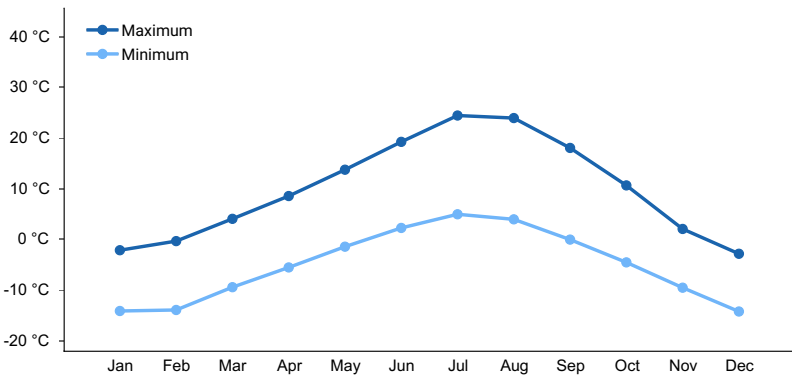

Figure 4. Monthly average minimum and maximum temperature

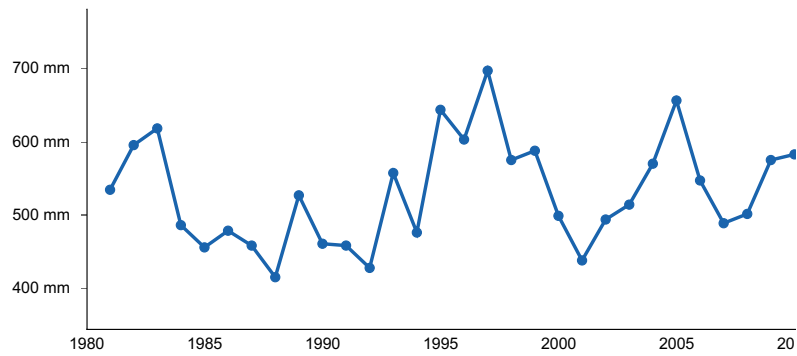

Figure 5. Annual precipitation pattern

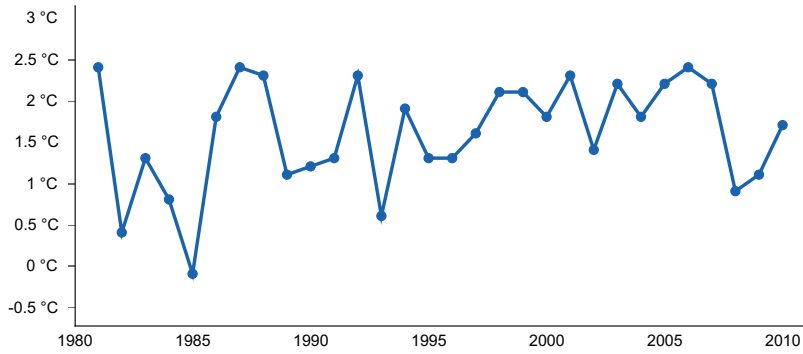

Figure 6. Annual average temperature pattern

Climate stations used

- (1) JACKSON [USC00484910], Jackson, WY
- (2) COOKE CITY 2 W [USC00241995], Gardiner, MT
- (3) BURGESS JUNCTION [USC00481220], Dayton, WY

Influencing water features

This site is not associated with any type of surface water feature. Snow drift impact is moderate.

Soil features

The soils associated with this site were derived from calcareous sandstone, limestone, quartzite-sandstone mixes, or granitics. These soils are generally less than 20” in depth and virtually impermeable to plant roots. Pockets of deep soil may occur in this site and are moderately acidic. The bedrock will include igneous, metamorphic and sedimentary material. The soil characteristic having the most influence on the plant community is the shallow depth and slope. Soil temperature regime is found on the upper extent of frigid and the lower extent of cryic; while, soil moisture regime is typic ustic to typic udic.



Figure 7. Hand pit excavated in a deep soil within the Upland Cool Woodlands ecological site.

Table 4. Representative soil features

Parent material	(1) Colluvium–limestone and dolomite (2) Residuum–granite and gneiss (3) Slope alluvium–igneous, metamorphic and sedimentary rock (4) Quartzite
-----------------	--

Surface texture	(1) Bouldery, stony sandy loam (2) Clay loam (3) Loam (4) Silty clay loam
Drainage class	Moderately well drained to well drained
Permeability class	Slow to rapid
Depth to restrictive layer	51 cm
Soil depth	51 cm
Surface fragment cover <=3"	0–20%
Surface fragment cover >3"	0–15%
Calcium carbonate equivalent (Depth not specified)	0–5%
Electrical conductivity (Depth not specified)	0–2 mmhos/cm
Subsurface fragment volume <=3" (Depth not specified)	0–20%
Subsurface fragment volume >3" (Depth not specified)	0–15%

Ecological dynamics

The cool extent of these deep soils tenders to the more timber species and provides for greater diversity in under story as well. In capturing the transitions in the community phases, there is opportunity to debate whether a transition is between community phases or states. In considering the time required for regeneration and growth of the forests in this climate as well as the fire frequency and management responses, transitions between significant stages of forest growth will be considered as states within this ecological site. Fire is a major player in the natural cycle of this community; however, frequency, intensity and type of fire will influence the shifts within communities. Logging and other alternative land uses has had an impact in these transitions, and these shifts will be described briefly in the following state and transition model. For more information concerning the major forest community groupings in this class, refer to the Habitat type guides referenced below.

State and transition model

Ecosystem states

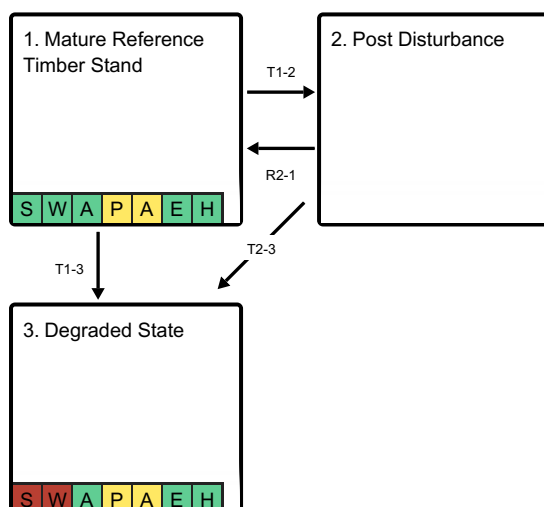

T1-2 - The recovery of a site following a high intensity fire removing the Douglas-fir over story leads to a lodge pole pine community.

T1-3 - Fire followed by erosion removes the soil cover encouraging herbaceous growth that inhibits the establishment of woody vegetation back to these eroded sites.

R2-1 - Given time and with timber management, Douglas-fir will recover and expand on the site. Low intensity fire patterns are needed to maintain and improve this community.

T2-3 - Extreme erosion following removes the soil cover encouraging herbaceous growth that inhibits the establishment of woody vegetation back to these eroded sites.

State 1 submodel, plant communities

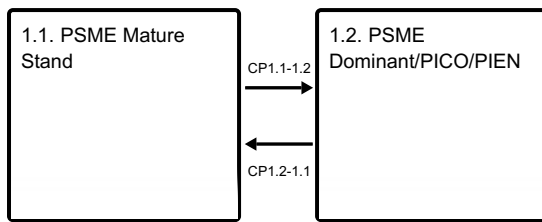

CP1.1-1.2 - Low frequency stand replacing fires opens the canopy encouraging mixed conifer growth and under story rejuvenation.

CP1.2-1.1 - Lack of fire or management leads to dense Douglas-fir timber stands, crowding out other conifers and reducing under story diversity.

State 2 submodel, plant communities

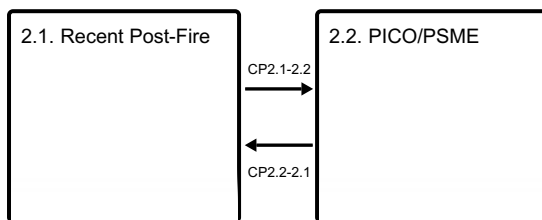

CP2.1-2.2 - Lack of fire, or with no impact to timber growth, the natural succession or recovery process trends to a lodge pole pine timber stand.

CP2.2-2.1 - Fire or timber management to open the canopy transitions a dense timber stand to a under story dominated community.

State 3 submodel, plant communities

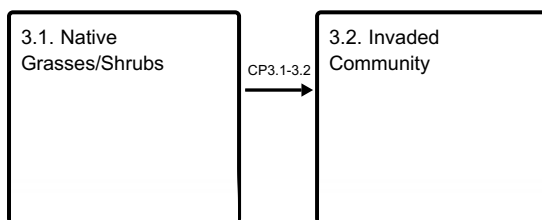

CP3.1-3.2 - Surface disturbances with a seed source present allows for this herbaceous community to be invaded by weedy species.

State 1 Mature Reference Timber Stand

The Reference State is comprised of Douglas-fir as the dominant over story, with a mixed shrub under story. Scattered grasses, grass-likes, and forbs are included. As this state matures, or ages, the density of the Douglas-fir increases, the under story will decrease and will shift in composition. The diversity in the under story is a factor of latitude and longitude as well as the side of the continental divide it resides on.

Characteristics and indicators. The dominant over story cover is Douglas-fir with an intermixed composition of lodge pole pine and englemann spruce. In some isolated areas, especially along the upper extent of this state/habitat type populations of white bark pine can be found, especially within the Absaroka Mountain Range. The under story is comprised of a mix of shrub species and a few grasses and grass-likes - primarily pinegrass and ross's sedge. Shrubs include Rocky mountain maple, huckleberry, ninebark, Spirea, Oregon grape, snowberry, whortleberry and others. Latitude, longitude and reference to the continental divide will influence the specific under story composition.

Resilience management. This state has evolved and is dependent on frequent, low severity fires that leave the mature trees, but help to thin the stand, reduce under story fuel loads and encourage rejuvenation of younger tree species. Mechanical means of doing this can be used to replace the natural fire regime, especially in areas that have become mature or prime for a severe burn.

Dominant plant species

- Douglas-fir (*Pseudotsuga menziesii*), tree
- lodgepole pine (*Pinus contorta*), tree
- Engelmann spruce (*Picea engelmannii*), tree
- whitebark pine (*Pinus albicaulis*), tree
- mallow ninebark (*Physocarpus malvaceus*), shrub
- white spirea (*Spiraea betulifolia*), shrub
- Oregon boxleaf (*Paxistima myrsinites*), shrub
- Rocky Mountain maple (*Acer glabrum*), shrub
- pinegrass (*Calamagrostis rubescens*), grass
- Ross' sedge (*Carex rossii*), grass
- Geyer's sedge (*Carex geyeri*), grass
- spike fescue (*Leucopoa kingii*), grass
- heartleaf arnica (*Arnica cordifolia*), other herbaceous
- western meadow-rue (*Thalictrum occidentale*), other herbaceous
- twinflower (*Linnaea borealis*), other herbaceous
- sweetroot (*Osmorhiza*), other herbaceous

Dominant resource concerns

- Plant productivity and health
- Plant structure and composition
- Wildfire hazard from biomass accumulation
- Terrestrial habitat for wildlife and invertebrates
- Feed and forage imbalance
- Inadequate livestock water quantity, quality, and distribution

Community 1.1

PSME Mature Stand



Figure 8. An open canopy Douglas-fir stand on the lower extent of the Cool Upland woodland ecological site.

The Douglas-fir mature growth stand is comprised of almost entirely of Douglas-fir. The under story is limited due to the closed canopy, but in areas where thinning has occurred, there is a mix of shrubs and herbaceous cover. These stands provide little grazing or forage, but are excellent cover and habitat. Fallen timber and litter are fire hazards and restrict movement through the tree stands.

Resilience management. These stands are resistant to change and relatively resilient with low intensity fires to clear under growth and old growth to maintain the stand. But the risk of intense or catastrophic fire in these mature growth stands is high.

Dominant plant species

- Douglas-fir (*Pseudotsuga menziesii*), tree

- mallow ninebark (*Physocarpus malvaceus*), shrub
- thinleaf huckleberry (*Vaccinium membranaceum*), shrub
- common juniper (*Juniperus communis*), shrub
- pinegrass (*Calamagrostis rubescens*), grass
- sedge (*Carex*), grass
- nodding brome (*Bromus anomalus*), grass
- arnica (*Arnica*), other herbaceous
- western meadow-rue (*Thalictrum occidentale*), other herbaceous
- aster (*Aster*), other herbaceous

Community 1.2

PSME Dominant/PICO/PIEN



Figure 9. Douglas-fir, white bark pine, and englemann spruce with a healthy under story on a Cool Upland Woodland ecological site.

This Mixed conifer stand is common in frequent low intensity stand replacing fires. Douglas-fir is the dominant species, with a composition of lodge pole pine as well as occurrences of englemann spruce and white bark pine. The under story composition is variable, but is generally high in shrubs and forbs and only scatter grasses, however, canopy openness is the dictating factor for the under story in these communities.

Resilience management. This community is resilient to change unless there is soil disturbance especially when additional disturbances are followed or preceded by fire. Fire is part of the natural rejuvenation of this site, so in the absence of fire, this site will decline in health and become susceptible to disease, insects and other disturbances.

Dominant plant species

- Douglas-fir (*Pseudotsuga menziesii*), tree
- lodgepole pine (*Pinus contorta*), tree
- thinleaf huckleberry (*Vaccinium membranaceum*), shrub
- common juniper (*Juniperus communis*), shrub
- white spirea (*Spiraea betulifolia*), shrub
- currant (*Ribes*), shrub
- pinegrass (*Calamagrostis rubescens*), grass
- sedge (*Carex*), grass
- nodding brome (*Bromus anomalus*), grass
- Montana wheatgrass (*Elymus albicans*), grass
- arnica (*Arnica*), other herbaceous
- aster (*Aster*), other herbaceous
- western meadow-rue (*Thalictrum occidentale*), other herbaceous

Pathway CP1.1-1.2

Community 1.1 to 1.2



PSME Mature Stand



PSME Dominant/PICO/PIEN

Low intensity stand replacing fires encourage an open canopy and rejuvenates species such as lodge pole pine, and engelmann spruce. The open canopy encourages new under story growth and creates a more mixed stand. Selective harvest and timber management strategies can create this same effect.

Conservation practices

Upland Wildlife Habitat Management
Forest Stand Improvement
Forest Land Management
Prescribed Forestry
Patch-burning to enhance wildlife habitat
Forest stand improvement for habitat and soil quality
Wildlife corridors
Forest stand improvement pre-treating vegetation and fuels
Forest Stand Improvement, Prescribed burning
Forest Stand Improvement to Reduce Wildfire Risk

Pathway CP1.2-1.1 Community 1.2 to 1.1



PSME Dominant/PICO/PIEN



PSME Mature Stand

Lack of fire, or timber management, encourages dense stands of Douglas-fir that will crowd out other conifer species and in time will reduce the under story canopy to minimal cover.

State 2 Post Disturbance

Following higher intensity fire or higher frequency of fire, significant logging events, or other major disturbances to the reference community, a shift to State 2 - Post Disturbance, occurs. This state is comprised of community phases that move from a shrub dominant under story with only young sampling cover of lodge pole pine, to a lodge pole pine community. Further management is needed to shift this back to a reference state.

Characteristics and indicators. This State is characterized by the prominence of lodge pole pine and very few if any Douglas-fir. Some englemann spruce will be present, and as this stand matures, more Douglas-fir may establish. Fireweed, buckbrush, snowberry, chokecherry, and serviceberry become more prevalent in this community. A stronger herbaceous community will be present in the first community phase while the over story canopy is more open. But as the tree community matures, this will shift to a more shrubby woody dominated community.

Resilience management. Frequent low intensity fires is needed to maintain both communities within this state, or the use of mechanical means to limit sapling growth and to maintain the under story and canopy in older growth stands.

Dominant plant species

- lodgepole pine (*Pinus contorta*), tree
- Engelmann spruce (*Picea engelmannii*), tree
- Douglas-fir (*Pseudotsuga menziesii*), tree
- ceanothus (*Ceanothus*), shrub
- western snowberry (*Symphoricarpos occidentalis*), shrub
- serviceberry (*Amelanchier*), shrub
- pinegrass (*Calamagrostis rubescens*), grass
- sedge (*Carex*), grass
- nodding brome (*Bromus anomalus*), grass
- fireweed (*Chamerion*), other herbaceous
- arnica (*Arnica*), other herbaceous
- aster (*Aster*), other herbaceous

Community 2.1 Recent Post-Fire



Figure 10. Late stages of the recent post fire community with young saplings.

This community is shrub dominated with saplings of young woody growth, generally lodge pole pine. The major shrubs in this community is buckbrush, snowberry, serviceberry, white spirea, and chokecherry. Areas of raspberry are also common. Fireweed is a major forb that will be prominent on the landscape. Geranium, lupine, chickweed, bedstraw, and a variety of other forbs will fill in the under story with some pinegrass, sedges, and fescues.

Resilience management. This community phase is a transitional phase and so is not resilient unless there is a frequent low intensity fire regime in place. Timber management can maintain this cover. However, if left to natural processes, this community is striving to return to a timbered community.

Dominant plant species

- lodgepole pine (*Pinus contorta*), tree
- currant (*Ribes*), shrub
- white spirea (*Spiraea betulifolia*), shrub
- ceanothus (*Ceanothus*), shrub
- western snowberry (*Symphoricarpos occidentalis*), shrub
- pinegrass (*Calamagrostis rubescens*), grass
- sedge (*Carex*), grass
- spike fescue (*Leucopoa kingii*), grass
- fireweed (*Chamerion*), other herbaceous
- aster (*Aster*), other herbaceous
- bedstraw (*Galium*), other herbaceous

Community 2.2

PICO/PSME



Figure 11. Mature lodge pole pine community with both Douglas-fir and englemann spruce present.

Recovery following intense fires tends towards a lodge pole pine dominated community. Douglas-fir maintain under low intensity, and with time will recover after a more catastrophic fire, lodge pole pines can recover relatively quickly in low frequency of fires. As the lodge pole pine increase in size and density, the under story shifts to a more herbaceous cover with shrubs rather than the shrub dominated.

Resilience management. This community, once matured, is resistant to change, unless fire is involved or logging/timber management practices are in place. The under story is relatively resistant to much impact, but again with fire, this can change rapidly. As the stand continues to mature/ages, Douglas-fir and englemann spruce will increase in the canopy.

Dominant plant species

- lodgepole pine (*Pinus contorta*), tree
- Douglas-fir (*Pseudotsuga menziesii*), tree
- Engelmann spruce (*Picea engelmannii*), tree
- mallow ninebark (*Physocarpus malvaceus*), shrub
- white spirea (*Spiraea betulifolia*), shrub
- western snowberry (*Symphoricarpos occidentalis*), shrub
- pinegrass (*Calamagrostis rubescens*), grass
- sedge (*Carex*), grass
- nodding brome (*Bromus anomalus*), grass
- spike fescue (*Leucopoa kingii*), grass
- arnica (*Arnica*), other herbaceous
- western meadow-rue (*Thalictrum occidentale*), other herbaceous
- twinflower (*Linnaea borealis*), other herbaceous

Pathway CP2.1-2.2

Community 2.1 to 2.2



Recent Post-Fire

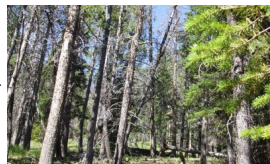

PICO/PSME

Natural succession or regeneration following fire leads to a timber stand of mainly lodge pole pine and a decreased under story. Lack of fire frequency, and with out any timber management or other impact to the tree canopy, this community will transition to a timber stand.

Pathway CP2.2-2.1 Community 2.2 to 2.1

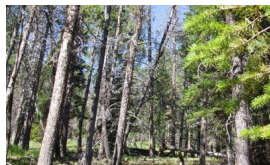

PICO/PSME



Recent Post-Fire

Stand replacement fires, low intensity fires remove the timber and open the canopy encouraging the shrubs and under story forage to increase. This natural process can also be expedited initiated with timber harvest practices. Removal of the old growth over story, opening the canopy leads to an increase of the under story dominance.

Conservation practices

Critical Area Planting
Upland Wildlife Habitat Management
Forest Stand Improvement
Prescribed Forestry
Patch-burning to enhance wildlife habitat
Forest stand improvement for habitat and soil quality
Wildlife corridors
Forest stand improvement pre-treating vegetation and fuels
Forest Stand Improvement, Prescribed burning

State 3 Degraded State

Following an intense fire, or fire followed by a sequence of severe weather, erosion is common. The loss of soil, litter and conditions needed for vegetation recovery greatly reduces the ability for this site to recover, especially woody vegetation. These areas tend to establish as a grass and shrub dominated community and do not transition to a woody canopy without significant inputs (planting of woody vegetation) with surface scarification to allow competition of the woody species with the herbaceous under story.

Characteristics and indicators. This state's main characteristic is the lack of woody vegetation. The indicator that this is a degraded woody site compared to an open parkland site, is that there is generally evidence of the erosion, the disturbance that led to the event - charred debris, clear-cut stumps or logging evidence, blow-down or similar debris that remains in the area. A grass and shrub dominated state is what is found. Shrubs include White spirea, serviceberry, chokecherry, a variety of currants, wild rose, and others. Grasses include pinegrass, Idaho fescue, king spike fescue, and rough fescue on the west divide. Nodding brome and mountain brome grasses, as well as a variety of rhizomatous wheatgrasses. A wide variety of forbs are expected on this site, but species will vary depending on the what extent of the range is being evaluated (latitude, longitude, west/east divide).

Resilience management. Grazing management is key on these areas. They are usually small in extent and can have impact from snow drift and snow runoff. Fire is still a factor with these sites, but has less of an impact overall. Drought, insect, and wildlife use are factors that affect the resiliency of this community. Overall, this community is stable and resistant to significant changes. Weedy invasions are possible. Thistle, houndstongue, and other weedy species are common invaders.

Dominant plant species

- currant (*Ribes*), shrub
- serviceberry (*Amelanchier*), shrub
- Woods' rose (*Rosa woodsii*), shrub
- mountain big sagebrush (*Artemisia tridentata* ssp. *vaseyana*), shrub
- pinegrass (*Calamagrostis rubescens*), grass
- spike fescue (*Leucopoa kingii*), grass
- Montana wheatgrass (*Elymus albicans*), grass
- sedge (*Carex*), grass
- brome (*Bromus*), grass
- aster (*Aster*), other herbaceous
- fireweed (*Chamerion*), other herbaceous
- field chickweed (*Cerastium arvense*), other herbaceous
- geranium (*Geranium*), other herbaceous
- lupine (*Lupinus*), other herbaceous

Dominant resource concerns

- Sheet and rill erosion
- Classic gully erosion
- Aggregate instability
- Drifted Snow
- Plant productivity and health
- Plant structure and composition
- Terrestrial habitat for wildlife and invertebrates
- Feed and forage imbalance
- Inadequate livestock water quantity, quality, and distribution

Community 3.1

Native Grasses/Shrubs



Figure 12. Clear-cut logging with no stand rejuvenation after 15 years of recovery.

This community phase will have remnant signs of fire or logging that removed the woody vegetation, but the site is dominated by herbaceous species. This community can have a broad diversity of species and may vary greatly with use. However, for this ecological site, the main capture is the long-term loss of woody vegetation and the dominance of shrubs and grasses within these small patch dynamics in the forest habitat.

Resilience management. This site is relatively resilient to change with limited management. Grazing impacts can be significant depending on the locality of other grazing forage and the size of the community. Fire has a limited impact on this site, but it does provide a unique forage base within a forested habitat.

Dominant plant species

- serviceberry (*Amelanchier*), shrub
- Woods' rose (*Rosa woodsii*), shrub
- currant (*Ribes*), shrub
- ceanothus (*Ceanothus*), shrub
- western snowberry (*Symphoricarpos occidentalis*), shrub
- pinegrass (*Calamagrostis rubescens*), grass
- spike fescue (*Leucopoa kingii*), grass
- Idaho fescue (*Festuca idahoensis*), grass
- Montana wheatgrass (*Elymus albicans*), grass
- brome (*Bromus*), grass
- sedge (*Carex*), grass
- fireweed (*Chamerion*), other herbaceous
- groundsel (*Tephrosia*), other herbaceous
- aster (*Aster*), other herbaceous
- geranium (*Geranium*), other herbaceous
- lupine (*Lupinus*), other herbaceous
- field chickweed (*Cerastium arvense*), other herbaceous

Community 3.2

Invaded Community



Figure 13. Thistle, fireweed, and aster invaded community three years post fire on this Douglas-fir/lodge pole pine community.

Following major disturbances where seed sources are present, a flush of native and invader species is common, especially following fire fighting operations as well as logging activities. A variety of thistles, houndstongue, smooth brome, and other aggressive introduced species will dominate a site. Mullein, elkweed and other natives can become over abundant on these sites as well, but with time will decrease unlike the introduced invaders.

Resilience management. Once these sites are invaded, without significant inputs to control in the invasive species, these communities will not improve. And without treatment and follow up management will continue to degrade and will spread to other surrounding communities.

Dominant plant species

- currant (*Ribes*), shrub
- Woods' rose (*Rosa woodsii*), shrub
- western snowberry (*Symphoricarpos occidentalis*), shrub
- smooth brome (*Bromus inermis*), grass
- Kentucky bluegrass (*Poa pratensis*), grass

- spike fescue (*Leucopoa kingii*), grass
- pinegrass (*Calamagrostis rubescens*), grass
- fireweed (*Chamerion*), other herbaceous
- thistle (*Cirsium*), other herbaceous
- aster (*Aster*), other herbaceous
- gypsyflower (*Cynoglossum officinale*), other herbaceous

Pathway CP3.1-3.2 Community 3.1 to 3.2



Native Grasses/Shrubs

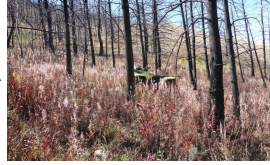

Invaded Community

Seed transport by wildlife, especially migratory species, recreation and livestock can introduce a variety of aggressive weedy species that will dominate the site; especially in areas that are impacted by rodent activity, frost heave, heavy use areas by wildlife and livestock, and other surface disturbances.

Context dependence. The composition and shift will vary from location to location. The type of weedy species will determine how limited the site will be after the invasion.

Transition T1-2 State 1 to 2

Fire is a natural process in this ecotype, however, if an intense or crown fire occurs, Douglas-fir is impacted and is slower to recover. Lodge pole pine can recover more rapidly in these situations. Following an intense fire, the herbaceous and shrub under story will remain prominent for extended time while the conifers rejuvenate. Once the trees recover, the site will transition to a lodge pole pine site.

Constraints to recovery. Seed source and time for recover of Douglas-fir is one constraint for this site to recover. When lodge pole pine establishes and becomes dominant, it is a matter of time before another disturbance opens the stand and allows Douglas-fir to establish or just the natural aging and thinning of the stand providing opportunity for the species transition.

Context dependence. The intensity of or frequency of fire and the circumstances of the fire, pre-fire community composition, and post-fire weather occurrences can shift the response of these communities.

Transition T1-3 State 1 to 3

Fire, generally higher intensity of fire, followed by extreme erosion caused by weather. Following fire, especially high intensity fires, there is little to know water retention or infiltration due to multiple different factors; so, if an intense storm hits with substantial rain fall, hail, wind, or other erosion factors, the litter, ash, and top soil and duff layers are quickly removed exposing raw and many times depleted soils. The loss of soil protection also takes seed sources and nursery plants needed for sites to recover. This leaves a site unable to recover the woody vegetation, and is more conducive to grasses, forbs, and drier shrubs.

Constraints to recovery. The lack of seed sources or nursery crops to encourage woody vegetation, with the inhibitions of a dense herbaceous cover to tree growth restricts the ability for this site to recover. These conditions are also prime for invasive or non-native species encroachment further restricting the recovery of the site.

Restoration pathway R2-1 State 2 to 1

Given time and with timber management, the community can be managed to encourage Douglas-fir to establish and gain in dominance. Thinning of the canopy, maintaining under story health and if necessary, planting saplings of

desired species will transition this site towards reference. There is a need to restore or allow the frequent low intensity stand replacement fires to occur to continue to encourage Douglas-fir and to minimize other conifer species.

Conservation practices

Upland Wildlife Habitat Management
Forest Stand Improvement
Forest Land Management
Prescribed Forestry
Patch-burning to enhance wildlife habitat
Forest stand improvement for habitat and soil quality
Wildlife corridors
Forest stand improvement pre-treating vegetation and fuels
Forest Stand Improvement, Prescribed burning
Forest Stand Improvement to Reduce Wildfire Risk
Forest stand improvement pre-treating vegetation and fuels preceding a prescribed fire

Transition T2-3

State 2 to 3

After a fire, if an intense storm hits with substantial rain fall, hail, wind, or other erosion factors, the litter, ash, and top soil and duff layers are quickly removed exposing raw and many times depleted soils. The loss of soil protection also takes seed sources and nursery plants needed for sites to recover. This leaves a site unable to recover the woody vegetation, and is more conducive to grasses, forbs, and drier shrubs.

Constraints to recovery. The lack of seed sources or nursery crops to encourage woody vegetation, with the inhibitions of a dense herbaceous cover to tree growth restricts the ability for this site to recover. These conditions are also prime for invasive or non-native species encroachment further restricting the recovery of the site.

Additional community tables

Animal community

This site and plant community complex has minimal livestock grazing capacity in the old stand forests. In new growth or following logging or fire, this site does provide some livestock forage. This site is common habitat for elk, mule deer, bear, wolf, mountain lion, and a variety of other wildlife.

Hydrological functions

Water is the principal factor limiting forage production on this site. This site is dominated by soils in hydrologic group C, with localized areas in hydrologic group B and D. Infiltration ranges from moderately slow to moderate. Runoff potential for this site varies from low to moderate depending on soil hydrologic group and ground cover. In many cases, areas with greater than 75% ground cover have the greatest potential for high infiltration and lower runoff. An example of an exception would be where short-grasses form a strong sod and dominate the site. Areas where ground cover is less than 50% have the greatest potential to have reduced infiltration and higher runoff (refer to Part 630, NRCS National Engineering Handbook for detailed hydrology information).

Rills and gullies should not typically be present. Water flow patterns should be barely distinguishable if at all present. Pedestals are only slightly present in association with bunchgrasses. Litter typically falls in place, and signs of movement are not common. Chemical and physical crusts are rare to nonexistent. Cryptogamic crusts are present, but only cover 1-2% of the soil surface.

Recreational uses

This site provides hunting opportunities for large ungulates and fur bearing species. Limited for upland game bird species. Hiking is limited by density of mature tree stands, otherwise provides an excellent area to camp, hike, and recreate.

Wood products

Timber harvest for lumber and firewood, as well as post and pole cuttings are common on this forest type. Christmas tree harvest occurs on lower extents of this forest type.

Other products

Berry harvest from under story species as well as medicinal plants can be found within this ecological site. Fungi (mushroom) harvest can also occur in specific locations.

Inventory data references

Information presented here has been derived from NRCS data and other inventory data.

Field observations from range trained personnel were also used. Those involved in developing this site include: Bill Christensen, Range Management Specialist, NRCS; Karen Clause, Range Management Specialist, NRCS; and Everet Bainter, Range Management Specialist, NRCS. Other sources used as references include: USDA NRCS Water and Climate Center, USDA NRCS National Range and Pasture Handbook, and USDA NRCS Soil Surveys from various counties.

Other references

Steele, Robert; Cooper, Stephen V.; Ondov, David M.; Roberts, David W.; Pfister, Robert D. 1983. Forest Habitat Types of Eastern Idaho-Western Wyoming. General Technical Report INT-144. Ogden, UT: U.S. Department of Agriculture, Forest Service, Intermountain Forest and Range Experiment Station. 122 p.

Contributors

Karen Clause, Multi-County Rangeland Management Specialist, USDA-NRCS

Bryan Christensen, Ecological Site Specialist, USDA-NRCS

Marji Patz, Ecological Site Specialist, USDA-NRCS

Approval

Kirt Walstad, 3/01/2024

Rangeland health reference sheet

Interpreting Indicators of Rangeland Health is a qualitative assessment protocol used to determine ecosystem condition based on benchmark characteristics described in the Reference Sheet. A suite of 17 (or more) indicators are typically considered in an assessment. The ecological site(s) representative of an assessment location must be known prior to applying the protocol and must be verified based on soils and climate. Current plant community cannot be used to identify the ecological site.

Author(s)/participant(s)	
Contact for lead author	
Date	05/17/2024
Approved by	Kirt Walstad
Approval date	

Indicators

1. **Number and extent of rills:**

2. **Presence of water flow patterns:**

3. **Number and height of erosional pedestals or terracettes:**

4. **Bare ground from Ecological Site Description or other studies (rock, litter, lichen, moss, plant canopy are not bare ground):**

5. **Number of gullies and erosion associated with gullies:**

6. **Extent of wind scoured, blowouts and/or depositional areas:**

7. **Amount of litter movement (describe size and distance expected to travel):**

8. **Soil surface (top few mm) resistance to erosion (stability values are averages - most sites will show a range of values):**

9. **Soil surface structure and SOM content (include type of structure and A-horizon color and thickness):**

10. **Effect of community phase composition (relative proportion of different functional groups) and spatial distribution on infiltration and runoff:**

11. **Presence and thickness of compaction layer (usually none; describe soil profile features which may be mistaken for compaction on this site):**

12. **Functional/Structural Groups (list in order of descending dominance by above-ground annual-production or live foliar cover using symbols: >>, >, = to indicate much greater than, greater than, and equal to):**

Dominant:

Sub-dominant:

Other:

Additional:

13. **Amount of plant mortality and decadence (include which functional groups are expected to show mortality or decadence):**
-

14. **Average percent litter cover (%) and depth (in):**
-

15. **Expected annual annual-production (this is TOTAL above-ground annual-production, not just forage annual-production):**
-

16. **Potential invasive (including noxious) species (native and non-native). List species which BOTH characterize degraded states and have the potential to become a dominant or co-dominant species on the ecological site if their future establishment and growth is not actively controlled by management interventions. Species that become dominant for only one to several years (e.g., short-term response to drought or wildfire) are not invasive plants. Note that unlike other indicators, we are describing what is NOT expected in the reference state for the ecological site:**
-

17. **Perennial plant reproductive capability:**
-