

Ecological site R043BY022ID Windswept Mountain Ridge 22+ PZ FEID-CAREX

Last updated: 2/03/2020
Accessed: 05/03/2024

General information

Provisional. A provisional ecological site description has undergone quality control and quality assurance review. It contains a working state and transition model and enough information to identify the ecological site.

MLRA notes

Major Land Resource Area (MLRA): 043B–Central Rocky Mountains

Major Land Resource Area (MLRA):

43B – Central Rocky Mountains – This MLRA is extensive including Montana, Idaho, Wyoming and a small portion in Utah. MLRA 43B includes the Rocky Mountains. A revision of the MLRA's in 2006 lead to the inclusion of the foothills with the mountains for much of Wyoming. Cartographic standards limited the ability to capture the foothills as a separate MLRA .

Further information regarding MLRAs, refer to: United States Department of Agriculture, Natural Resources Conservation Service. 2006. Land Resource Regions and Major Land Resource Areas of the United States, the Caribbean, and the Pacific Basin. U.S. Department of Agriculture Handbook 296.
Available electronically at: http://www.nrcs.usda.gov/wps/portal/nrcs/detail/soils/ref/?cid=nrcs142p2_053624#handbook.

Classification relationships

Major Land Resource Area (MLRA): 043B–Central Rocky Mountains
Land Resource Unit: E (Rocky Mountain Range and Forested)

EPA EcoRegion: Level III (Middle Rockies)

Ecological site concept

Site does not receive any additional water.

Soils are:

not saline or saline-sodic.

moderately deep, deep, with >35% stone (10-25") and boulder (>25") cover. skeletal within 20" of soil surface, fragment percentage increasing with depth

not strongly or violently effervescent in surface mineral 10".

textures usually range from very fine sandy loam to clay loam in surface mineral 4".

Slope is < 30%.

Clay content is = <35% in surface mineral 4".

Site does not have an argillic horizon with > 35% clay.

Associated sites

R043BY002ID	Granitic 22+ PZ ARTRV/FEID
-------------	----------------------------

R043BY003ID	Loamy 22+ PZ FEID-PSSPS
R043BY004ID	Shallow Fractured Stony Loam 16-22 PZ ARTRV/FEID
R043BY009ID	Loamy 16-22 PZ ARTRV/FEID
R043BY017ID	Shallow Stony 22+ PZ ARTRV/FEID
R043BY018ID	South Slope Stony 22+ PZ PSSP6-FEID
R043BY019ID	North Slope Loamy 16-22 PZ SYORU/FEID-PSSPS
R043BY020ID	South Slope Gravelly 16-22 PZ ARTRV/BRMA4-ELTRT

Table 1. Dominant plant species

Tree	Not specified
Shrub	Not specified
Herbaceous	Not specified

Physiographic features

This site occurs on or near mountain ridgetops and divides that are exposed to the winds. Elevations range from 7500 to 10000 feet (2250-3050 meters). Slopes range from 0 to 30 percent.

Table 2. Representative physiographic features

Landforms	(1) Hill
Elevation	2,286–3,048 m
Slope	0–30%
Aspect	Aspect is not a significant factor

Climatic features

The Central Rocky Mountains range in elevation from 6000 to 10000 feet above sea level with some peaks reaching over 12000 feet. The average annual precipitation, based on 10 long term climate stations located throughout the MLRA , is 21 inches. The annual average minimum is 18 and the annual average maximum recorded is 24 inches. The annual average temperature is 41.7 degrees Fahrenheit. The annual average low is 26.7 and the annual average high is 56.7 degrees F. The frost free period ranges from 58 to 80 days while the freeze free period ranges from 90 to 116 days.

Table 3. Representative climatic features

Frost-free period (average)	80 days
Freeze-free period (average)	116 days
Precipitation total (average)	610 mm

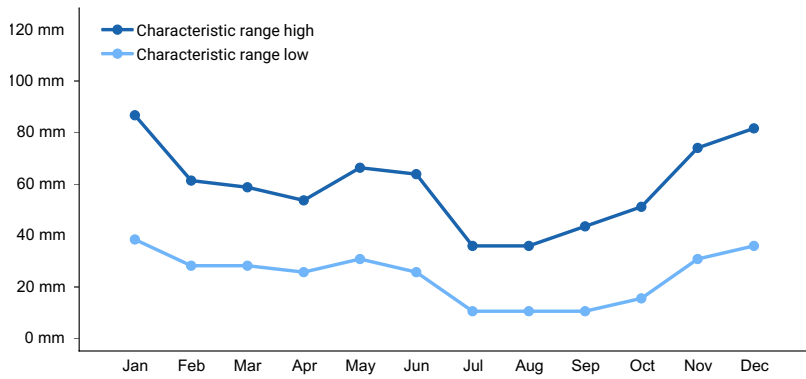

Figure 1. Monthly precipitation range

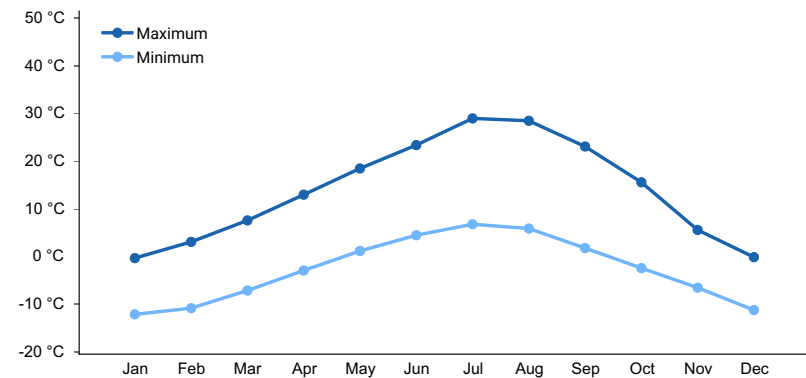

Figure 2. Monthly average minimum and maximum temperature

Influencing water features

This site is not influenced by adjacent wetlands, streams, or run on.

Soil features

Soils are moderately deep to very deep and well drained with moderate permeability. The top soils are generally loams over subsoils of sandy loams to stony loams. Available water holding capacity (AWC) is high but low availability due to winds. Frozen soils early in the growing season can perch surface moisture before thawing allows internal drainage

Soil Series Correlated to this Ecological Site

No Data

Ecological dynamics

The dominant visual aspect of this site is an herbaceous layer with a variety of grasses and forbs. Idaho fescue is the dominant grass. There are no shrubs. Composition by weight is approximately 50 to 60 percent grasses and 40 to 50 percent forbs.

During the last few thousand years, this site has evolved in a montane climate characterized by dry summers and cold, moist winters with long periods of high winds. Herbivory has historically occurred on this site at low levels of utilization. Herbivores include mule deer, Rocky Mountain elk, and lagomorphs.

Fire has historically occurred on the site at intervals of 20 - 50 years.

The Historical Climax Plant Community (HCPC), the Reference State (State 1), moves through many phases depending on the natural and man-made forces that impact the community over time. State 1, described later, indicates some of these phases. The Reference Plant Community Phase is Phase A. This plant community is dominated by Idaho fescue with Reynolds' sedge, elk sedge, ovalhead sedge, and prairiesmoke being prevalent.

The plant community is very diverse and there are a large variety of other grasses and forbs in minor amounts. The plant species composition of Phase A is listed later under "Reference Plant Community Phase Plant Species Composition".

Total annual production is 1100 pounds per acre (1232 kilograms per hectare) in a normal year. Production in a favorable year is 1700 pounds per acre (1904 kilograms per hectare). Production in an unfavorable year is 500 pounds per acre (560 kilograms per hectare). Structurally, cool season deep-rooted perennial bunchgrasses are more dominant than forbs.

FUNCTION:

Big game animals use the site in the spring because it is the one of the first sites to warm up and is clear of snow. This allows plant growth to start earlier. Livestock use is best suited for spring and fall. This site has little value for recreational value except for some hiking.

Due to ease of access, this site is susceptible to degradation from improper grazing management. The site has slight to moderate limitation for livestock grazing. Runoff, when it does occur can be erosive particularly during high intensity summer convection storms.

Impacts on the Plant Community.

Influence of fire:

In the absence of normal fire frequency and ungulate grazing, Idaho fescue can become decadent. This is apparent by dead centers in the crown.

When fires become more frequent than historic levels (20-50 years), Idaho fescue can be reduced in the plant community. With continued short fire frequency, this species can be completely eliminated along with some forbs. These species may be replaced by a variety of annual and perennial forbs including noxious and invasive species. These fine fuels will cause fires to become more frequent. Kentucky bluegrass may invade the site. Reynolds' sedge, elk sedge, ovalhead sedge, and other rhizomatous species will usually increase.

Influence of improper grazing management:

Season-long grazing and/or excessive utilization can be very detrimental to this site. This type of management leads to reduced vigor of the bunchgrasses. With reduced vigor, recruitment of these species declines. As these species decline, an increase in many forbs will occur and noxious and invasive plants will invade. Kentucky bluegrass may invade the site.

Continued improper grazing management influences fire frequency by increasing fine fuels that carry fires. As annuals increase, fires become more frequent.

Proper grazing management that addresses frequency, duration, and intensity of grazing can also keep fine fuels from developing, thereby reducing fire frequency. A planned grazing system can be developed to intentionally accumulate fine fuels in preparation for a prescribed burn. A prescribed burn on this specific site would only occur under extremely rare circumstances.

Weather influences:

Above normal precipitation in May and June can dramatically increase total annual production of the plant community. These weather patterns can also increase viable seed production of desirable species to provide for recruitment. Likewise, below normal precipitation during these spring months can significantly reduce total annual production and be detrimental to viable seed production. Overall plant composition is normally not affected when perennials have good vigor.

An early, hard freeze can occasionally kill some plants. Prolonged drought adversely affects this plant community in several ways. Vigor, recruitment, and production are usually reduced. Mortality can occur. Prolonged drought can

lead to a reduction in fire frequency.

Influence of Insects and disease:

Outbreaks can affect vegetation health. Grasshopper outbreaks occur periodically. Outbreaks seldom cause plant mortality since defoliation of the plant occurs only once during the year of the outbreak.

Influence of noxious and invasive plants:

Many of these species add to the fine-fuel component and lead to increased fire frequency. Annual and perennial invasive species compete with desirable plants for moisture and nutrients. The result is reduced production and change in composition of the understory.

Influence of wildlife:

Big game animals will use this site in the spring. Their numbers are seldom high enough to adversely affect the plant community.

Watershed:

Decreased infiltration and increased runoff occur with a decrease in perennial bunchgrasses. This composition change can affect nutrient and water cycles. Increased runoff also causes sheet and rill erosion. Abnormally short fire frequency also gives the same results, but to a lesser degree. The long-term effect is a transition to a different state.

Plant Community and Sequence:

Transition pathways between common vegetative states and phases:

State 1.

Phase A to B. Develops with improper grazing management and no fire.

Phase A to C. Develops with fire.

Phase B to A. Develops with prescribed grazing.

Phase C to A. Develops with prescribed grazing and no fire.

State 1, Phase B or C to State 2. Develops through frequent fire and/or continued improper grazing management. This site has crossed a vegetative threshold. It is economically impractical to return this plant community to State 1 with accelerating practices.

State 2 to unknown site. Excessive soil loss and changes in the hydrologic cycle caused by continued improper grazing management and/or frequent fire cause this state to cross a threshold and retrogress to a new site with reduced potential. It is economically impractical to return this plant community to State 1 with accelerating practices.

Practice Limitations:

Moderate to severe limitations exist on this site for accelerated practices due to low available soil moisture due to the wind drying the surface soils. Slight limitations exist for facilitating and vegetative management practices.

State and transition model

STATE 1. Plant Community Phases

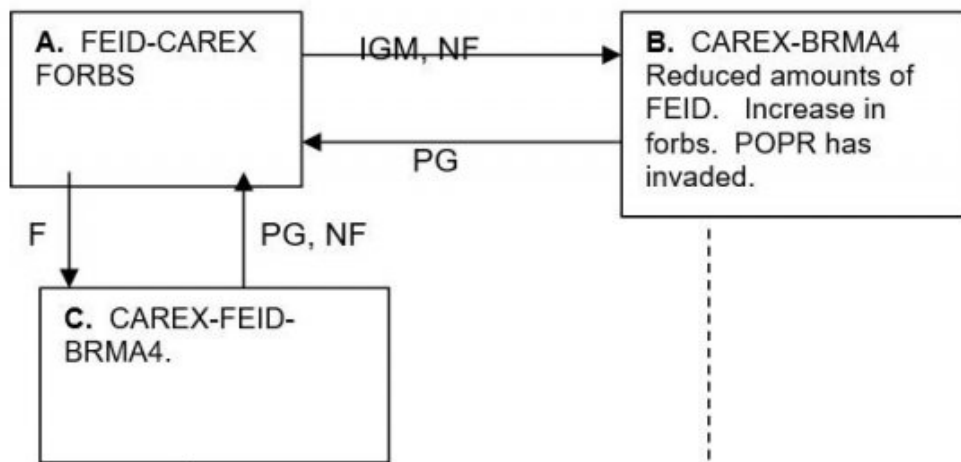

FF
&/or
IGM

FF
&/or
IGM

STATE 2.
ANNUALS, FORBS, INVASIVE, and
NOXIOUS PLANTS.

IGM &/or FF

UNKNOWN AND
NEW SITE

LEGEND

IGM- Improper grazing management
PG- Prescribed grazing
FF- Frequent fire
NF- No fire
F- Fire

————> Community pathway (within states)

-----> Reversible transition

———— Threshold

————> Irreversible transition

PLANT LEGEND STATES 1 & 2

CAREX - Sedges
FEID - Idaho Fescue
BRMA4 - Mountain Brome
POPR - Kentucky Bluegrass

State 1 State 1 Phase A

Community 1.1 State 1 Phase A

Reference Plant Community Phase. This plant community is dominated by Idaho fescue with Reynolds' sedge, elk sedge, ovalhead sedge, and prairiesmoke being prevalent. The plant community is very diverse and there are a

large variety of other grasses and forbs in minor amounts. Natural fire frequency is 20-50 years.

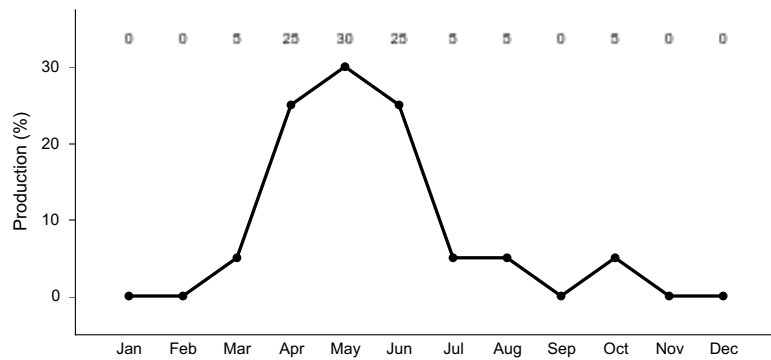

Figure 3. Plant community growth curve (percent production by month). ID1205, FEID-PSSPS. State 1.

**State 2
State 1 Phase B**

**Community 2.1
State 1 Phase B**

This plant community is dominated by several sedge species with reduced amounts of Idaho fescue. Mountain brome has increased significantly. All deep-rooted bunchgrasses are typically in low vigor. Forbs have increased. Some Kentucky bluegrass has invaded the site along with some annuals. This state has developed due to improper grazing management and the lack of fire.

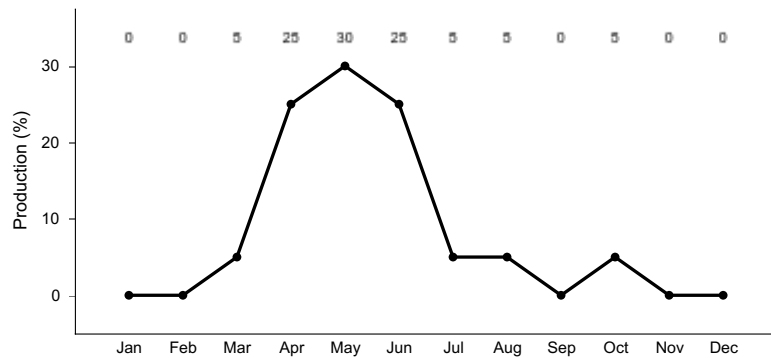

Figure 4. Plant community growth curve (percent production by month). ID1205, FEID-PSSPS. State 1.

**State 3
State 1 Phase C**

**Community 3.1
State 1 Phase C**

This plant community is dominated by several species of sedges and Idaho fescue. Some Idaho fescue may have died due to fire. Mountain brome has increased. Forbs are about in the same proportion as in Phase A. Some annuals may have invaded the site. This plant community is the result of wildfire.

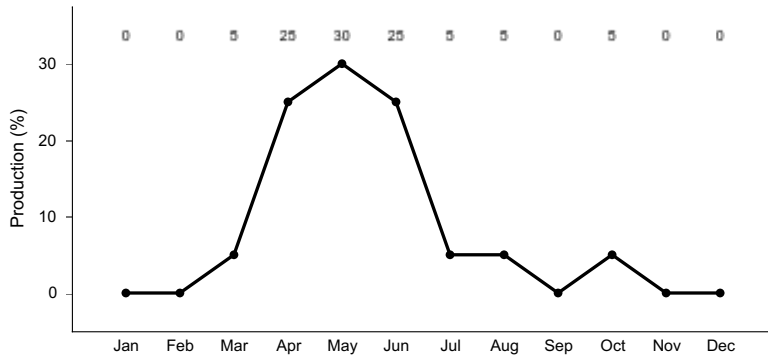

Figure 5. Plant community growth curve (percent production by month). ID1205, FEID-PSSPS. State 1.

**State 4
State 2**

**Community 4.1
State 2**

This plant community is dominated by annual grasses and forbs including invasive and noxious plants. Some shrubs such as rabbitbrush may have invaded the site in small amounts. Some soil loss has occurred. The annuals are controlling the site. This state has developed due to frequent fires and/or improper grazing management. This site has crossed a vegetative threshold. It is economically impractical to return this plant community to State 1 with accelerating practices.

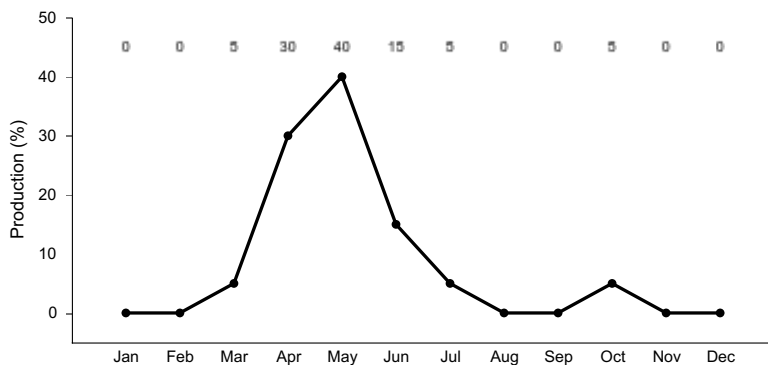

Figure 6. Plant community growth curve (percent production by month). ID1202, ANNUALS. State 2.

**State 5
Unknown New Site**

**Community 5.1
Unknown New Site**

This plant community has gone over the threshold to a new site. Site potential has been reduced. Significant soil loss has occurred. Infiltration has been reduced and run-off has become more rapid. This state has developed due to continued improper grazing management and/or frequent fires. It is economically impractical to return this plant community to State 1 with accelerating practices.

Additional community tables

Animal community

Wildlife Interpretations.
Animal Community – Wildlife Interpretations

This ecological site provides diverse habitat for upland wildlife species. Habitat is provided for resident and migratory animals including western toad, shrews, bats, jackrabbits, ground squirrels, mice, coyote, red fox, badger, sage-grouse, Ferruginous hawk, prairie falcon, grasshopper sparrow, horned lark, and western meadowlark. Large herbivore use of the ecological site is dominated by mule deer and elk. Area sensitive species include western toad, Greater sage-grouse, and sharp-tailed grouse. Open water is seasonal, being provided by seasonal runoff, ponding, and natural springs.

State 1 Phase 1.1 - Idaho Fescue/ Carex/ Forbs Reference Plant Community (RPC): The RPC provides a diversity of grasses and forbs used by native insect communities who assist in pollination of the plant community. The high level of forb production supports insects that are food for the many predator species utilizing the site. The reptile and amphibian community is represented by rubber boa, western toad, and northern leopard frog. Amphibians are associated with springs adjacent to this plant community. Development of spring sites that collect all available water would exclude amphibian use on these sites. Sage-grouse utilize the meadows as summer and fall brood-rearing habitat. The plant community supports spring, summer, and fall forage for elk and spring and fall forage for mule deer. A diverse small mammal population including deer mouse, Merriam's shrew, and yellow-bellied marmot may utilize the site.

State 1 Phase 1.2 – Carex/ Mountain Brome Plant Community: This phase has developed due to improper grazing management and a lack of fire. Insect diversity and populations would be similar to those in the State 1 Phase 1.1 plant community. The reptile and amphibian community would be similar to the State 1 Phase 1.1 community. The plant community provides summer and fall brood-rearing habitat for sage-grouse. The plant community can provide forage for large herbivores but with continued improper grazing management the quality and quantity of forage would be reduced in the summer and fall. When properly managed, Kentucky bluegrass can provide desirable forage for deer and elk. A diverse small mammal population including deer mouse, Merriam's shrew, and yellow-bellied marmot may utilize the site.

State 1 Phase 1.3 – Carex/ Idaho Fescue/ Mountain Brome Plant Community: This plant community is the result of wildfire. Under proper grazing management the plant community would develop to be similar to the State 1 Phase 1.1 plant community. Under proper grazing management the animal community would develop over time to be similar to the State 1 Phase 1.1 animal community.

State 2 –Annual Grasses/ Annual Forbs/ Invasives/ Noxious Weeds Plant Community: This state has developed due to frequent fires and/or improper grazing management. Pollinator habitat may not be sustained throughout all seasons. Nesting habitat for grassland birds would be limited due to poor cover from annual grasses and forbs. Birds of prey may range throughout these areas looking for prey species. The mule deer and elk grazing season would be shortened due to poor vigor and production of the herbaceous vegetation. Small mammal populations and diversity would be reduced due to poor cover throughout the year and increased vulnerability to predators.

Grazing Interpretations.

This site is suitable for spring and fall grazing by livestock.

Estimated initial stocking rate will be determined with the landowner or decision-maker. They will be based on the inventory which includes species, composition, similarity index, production, past use history, season of use, and seasonal preference. Calculations used to determine estimated initial stocking rate will be based on forage preference ratings.

Hydrological functions

No data.

Recreational uses

The site has slight recreational value. Some opportunities exist for hiking and photography. Some aesthetic value does exist due to topographic setting on ridges.

Wood products

None.

Other products

None.

Other information

Field Offices

Grangeville, ID
Nezperce, ID
Cascade, ID
Weiser, ID
Emmett, ID
Mtn. Home, ID
Salmon, ID
Challis, ID
Shoshone, ID
Arco, ID
St. Anthony, ID
Gooding, ID
Lewiston, ID
Orofino, ID

Inventory data references

Information presented here has been derived from NRCS clipping and other inventory data. Also, field knowledge of range-trained personnel was used. Those involved in developing this site description include:

Dave Franzen, co-owner, Intermountain Rangeland Consultants, LLC

Jacy Gibbs, co-owner, Intermountain Rangeland Consultants, LLC

Jim Cornwell, Range Management Specialist, IASCD

Brendan Brazee, State Rangeland Management Specialist, NRCS, Idaho

Bruce Knapp, Resource Soil Scientist, NRCS, Idaho

Lee Brooks, Range Management Specialist, IASCD

Other references

USDA Forest Service, Rocky Mountain Research Station. 2004. Restoring Western Ranges and Wildlands. General Technical Report RMRS-GTR-136-vols. 1-3.

USDA, NRCS.2001. The PLANTS Database, Version 3.1 (<http://plants.usda.gov>). National Plant Data Center, Baton Rouge, LA 70874-4490 USA.

USDA, Forest Service, Fire Effects Information Database. 2004. www.fs.fed.us/database/feis.

USDI Bureau of Land Management, US Geological Survey; USDA Natural Resources Conservation Service, Agricultural Research Service; Interpreting Indicators of Rangeland Health. Technical Reference 1734-6; Version 4-2005.

Approval

Scott Woodall, 2/03/2020

Rangeland health reference sheet

Interpreting Indicators of Rangeland Health is a qualitative assessment protocol used to determine ecosystem condition based on benchmark characteristics described in the Reference Sheet. A suite of 17 (or more) indicators are typically considered in an assessment. The ecological site(s) representative of an assessment location must be known prior to applying the protocol and must be verified based on soils and climate. Current plant community

cannot be used to identify the ecological site.

Author(s)/participant(s)	Dave Franzen and Jacy Gibbs Intermountain Range Consultants 17700 Fargo Rd. Wilder, ID 83676
Contact for lead author	Brendan Brazee, State Rangeland Management Specialist USDA-NRCS 9173 W. Barnes Drive, Suite C, Boise, ID 83709
Date	06/15/2009
Approved by	Scott Woodall
Approval date	
Composition (Indicators 10 and 12) based on	Annual Production

Indicators

- 1. Number and extent of rills:** rills are rare on this site. If they are present they are likely to occur immediately following wildfire. Rills are most likely to occur on soils with surface textures of silt loam and clay loam and on slopes greater than 15 percent.

- 2. Presence of water flow patterns:** water-flow patterns are rare on the site. When they occur, they are short and disrupted by cool season grasses and shrubs and are not extensive.

- 3. Number and height of erosional pedestals or terracettes:** both are rare on the site. In areas where flow patterns and/or rills are present, a few pedestals may be expected. They are not extensive. Do not mistake frost heaving for pedestalling.

- 4. Bare ground from Ecological Site Description or other studies (rock, litter, lichen, moss, plant canopy are not bare ground):** data is not available. On areas in mid-seral status bare ground may range from 25 to 35 percent.

- 5. Number of gullies and erosion associated with gullies:** none.

- 6. Extent of wind scoured, blowouts and/or depositional areas:** are not present. Immediately following wildfire some soil movement may occur on lighter textured soils.

- 7. Amount of litter movement (describe size and distance expected to travel):** fine litter in the interspaces may move up to 3 feet following a significant run-off event or leave the site due to wind. Coarse litter generally does not move.

- 8. Soil surface (top few mm) resistance to erosion (stability values are averages - most sites will show a range of values):** values should range from 4 to 6 but needs to be tested.

- 9. Soil surface structure and SOM content (include type of structure and A-horizon color and thickness):** no data.

-
10. **Effect of community phase composition (relative proportion of different functional groups) and spatial distribution on infiltration and runoff:** bunchgrasses, especially deep-rooted perennials, slow run-off and increase infiltration.
-
11. **Presence and thickness of compaction layer (usually none; describe soil profile features which may be mistaken for compaction on this site):** there is none present.
-
12. **Functional/Structural Groups (list in order of descending dominance by above-ground annual-production or live foliar cover using symbols: >>, >, = to indicate much greater than, greater than, and equal to):**
- Dominant: cool season deep-rooted perennial bunchgrasses
- Sub-dominant: forbs
- Other:
- Additional:
-
13. **Amount of plant mortality and decadence (include which functional groups are expected to show mortality or decadence):** Idaho fescue can become decadent in the absence of normal fire frequency and ungulate grazing. This is evident by dead centers in the crowns.
-
14. **Average percent litter cover (%) and depth (in):** additional litter cover data is needed but is expected to be 10-20 percent to a depth of 0.1 inches. Under mature shrubs litter is >0.5 inches deep and is 90-100 percent ground cover. Often litter is blown off the site.
-
15. **Expected annual annual-production (this is TOTAL above-ground annual-production, not just forage annual-production):** is 1100 pounds per acre (1232 kilograms per hectare) in a year with normal temperatures and precipitation. Perennial grasses produce 50-60 percent of the total production and forbs 40-50 percent.
-
16. **Potential invasive (including noxious) species (native and non-native). List species which BOTH characterize degraded states and have the potential to become a dominant or co-dominant species on the ecological site if their future establishment and growth is not actively controlled by management interventions. Species that become dominant for only one to several years (e.g., short-term response to drought or wildfire) are not invasive plants. Note that unlike other indicators, we are describing what is NOT expected in the reference state for the ecological site:** includes bulbous bluegrass, Kentucky bluegrass, rush skeletonweed, musk and scotch thistle, diffuse and spotted knapweed, leafy spurge, dalmation toadflax, and yellow star thistle.
-
17. **Perennial plant reproductive capability:** all functional groups have the potential to reproduce in most years.
-

