

Ecological site EX044B01A001 Clayey (Cy) LRU 01 Subset A

Last updated: 5/01/2024
Accessed: 05/02/2024

General information

Provisional. A provisional ecological site description has undergone quality control and quality assurance review. It contains a working state and transition model and enough information to identify the ecological site.

MLRA notes

Major Land Resource Area (MLRA): 044B—Central Rocky Mountain Valleys

Major Land Resource Area (MLRA) 44B, Central Rocky Mountain Valleys, is nearly 3.7 million acres of southwest Montana and borders two MLRAs: 43B Central Rocky Mountains and 46 Northern and Central Rocky Mountain Foothills.

The major watersheds of this MLRA are the Missouri and Yellowstone Rivers and their associated headwaters, such as the Beaverhead, Big Hole, Jefferson, Ruby, Madison, Gallatin, and Shields Rivers. These waters allow for extensive irrigation for crop production in an area that would generally only be compatible with rangeland and grazing. The Missouri River and its headwaters are behind several reservoirs that supply irrigation water, hydroelectric power, and municipal water. Limited portions of the MLRA are west of the Continental Divide along the Clark Fork River.

The primary land use of this MLRA is production agriculture (grazing, small grain production, and hay) and some limited mining. Urban development is high, with large expanses of rangeland converted to subdivisions for a rapidly growing population.

The MLRA comprises one Land Resource Unit (LRU) and seven climate-based LRU subsets. These subsets are based on Relative Effective Annual Precipitation (REAP) and frost-free days. Each subset expresses a distinct set of plants that differentiate it from other LRU subsets. Annual precipitation ranges from a low of 9 inches to a high of nearly 24 inches. The driest areas tend to be in the valley bottoms of southwest Montana in the rain shadow of the mountains. The wettest portions tend to be near the edge of the MLRA at the border with MLRA 43B. Frost-free days vary widely from less than 30 days in the Big Hole Valley to around 110 days in the warm valleys along the Yellowstone and Missouri Rivers.

The plant communities of the MRLA are highly variable, but the dominant community is a cool-season grass and shrub-steppe community. Warm-season grasses have a minimal extent in this MLRA. Most subspecies of big sagebrush are present, to some degree, across the MLRA.

LRU notes

MLRA 44B has one LRU that covers the entire MLRA. The LRU comprises seven climate subsets based on Relative Effective Annual Precipitation (REAP) and frost-free days. Combinations of REAP and frost-free days result in a common plant community shared across the LRU subset. Each subset is given a letter designation of A through F for sites that do not receive additional water and Y for sites that receive additional water.

LRU 01 Subset A has a REAP of 9 to 14 inches (228.6-355.6 mm) with a frost-free days range of 70 to 110. This combination of REAP and frost-free days results in a nearly treeless sagebrush steppe landscape.

The soil moisture regime is ustic, dry bordering on aridic, and has a frigid soil temperature regime.

Classification relationships

Grassland and Shrubland Habitat Types of Western Montana. (Mueggler and Stewart, 1980)

1. *Agropyron spicatum/Bouteloua gracilis* habitat type
2. *Artemisia tridentata/Agropyron spicatum* habitat type
3. *Agropyron spicatum/Agropyron smithii* habitat type

EPA Ecoregions of North America (U.S. EPA. 2013):

Level I: Northwestern Forested Mountains

Level II: Western Cordillera

Level III: Middle Rockies and Northwestern Great Plains

Level IV: Paradise Valley

Townsend Basin

Dry Intermontane Sagebrush Valleys

Shield-Smith Valleys

USDA Forest Service National Hierarchical Framework of Ecological Units (Cleland et al., 2007):

Domain: Dry

Division: M330 – Temperate Steppe Division – Mountain Provinces

Province: M332 –Middle Rocky Mountain Steppe – Coniferous Forest – Alpine Meadow

Section: M332D – Belt Mountains Section

M332E – Beaverhead Mountains Section

Subsection: M332Ej – Southwest Montana Intermontane Basins and Valleys

M332Dk – Central Montana Broad Valleys

Ecological site concept

The Clayey Ecological Site is an upland site formed from alluvium or slope alluvium and is on slopes less than 15 percent. The site does not receive additional moisture from a water table or flooding. It has 32 to 45 percent clay in the upper 4 inches (10 cm) of the mineral surface. It is moderately deep to very deep and has no root-restrictive layers within 20 inches (50 cm). The surface of the site has less than five percent stones and is not skeletal, with less than 35 percent rock fragments in the 10 to 20 inch (25 to 50 cm) depth. The site has no saline or saline-sodic influence and is not strongly or violently effervescent within 4 inches of the mineral surface. Calcium carbonates may increase with depth.

Associated sites

EX044B01A131	<p>Shallow Clay (SwC) LRU 01 Subset A</p> <p>The Shallow Clay Ecological Site is often a neighboring site on a higher landscape position. The plant community has a similar species presence. However, overall composition percentages and hydrology are reduced due to shallow bedrock.</p>
--------------	-----------------------------------------------------------------------------------------------------------------------------------------------------------------------------------------------------------------------------------------------------------------------------------------------------

Similar sites

EX044B01A032	<p>Loamy (Lo) LRU 01 Subset A</p> <p>The Loamy Ecological Site has a similar plant community but tends to have higher bluebunch wheatgrass production. It exists in a similar landscape position. The Loamy Ecological Site will express higher production values. The Loamy Ecological Site has reduced clay content in the soil profile compared to the Clayey Ecological Site.</p>
--------------	----------------------------------------------------------------------------------------------------------------------------------------------------------------------------------------------------------------------------------------------------------------------------------------------------------------------------------------------------------------------------------------------

Table 1. Dominant plant species

Tree	Not specified
Shrub	(1) <i>Artemisia tridentata</i>
Herbaceous	(1) <i>Pseudoroegneria spicata</i> (2) <i>Nassella viridula</i>

Legacy ID

R044BA001MT

Physiographic features

The Clayey Ecological Site is on nearly level to moderately steep alluvial fans, fan remnants, and hills. This ecological site is on slopes ranging from 1 to 15 percent. However, the core concept slopes of this ecological site exist in the 4 to 10 percent range.

Table 2. Representative physiographic features

Landforms	(1) Intermontane basin > Alluvial fan (2) Intermontane basin > Fan remnant (3) Intermontane basin > Hill
Flooding frequency	None
Ponding frequency	None
Elevation	1,219–1,981 m
Slope	4–10%
Water table depth	254 cm
Aspect	W, NW, N, NE, E, SE, S, SW

Table 3. Representative physiographic features (actual ranges)

Flooding frequency	Not specified
Ponding frequency	Not specified
Elevation	Not specified
Slope	1–15%
Water table depth	Not specified

Climatic features

The Central Rocky Mountain Valleys MLRA has a continental climate. Some of Montana's driest areas are in sheltered mountain valleys due to the rain-shadow effects of the neighboring mountain ranges. The average precipitation for LRU 01 Subset A is 12 inches (305 mm), and the frost-free period averages 78 days. Fifty to 60 percent of the annual precipitation falls between May and August, and precipitation is highest in May and June.

Table 4. Representative climatic features

Frost-free period (characteristic range)	70-110 days
Freeze-free period (characteristic range)	110-140 days
Precipitation total (characteristic range)	229-356 mm
Frost-free period (actual range)	70-110 days
Freeze-free period (actual range)	110-140 days
Precipitation total (actual range)	229-356 mm
Frost-free period (average)	78 days
Freeze-free period (average)	125 days
Precipitation total (average)	305 mm

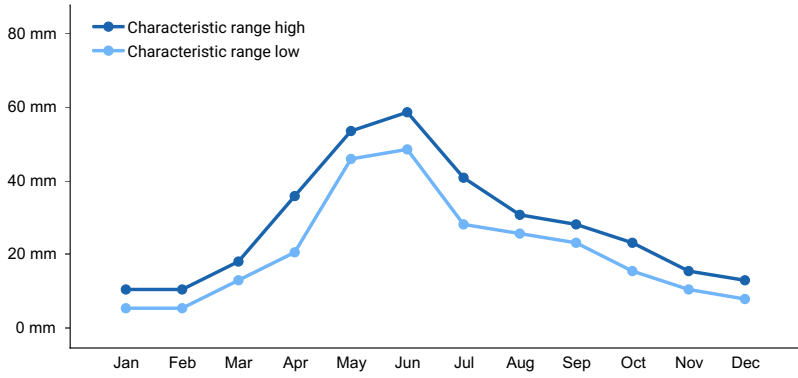

Figure 1. Monthly precipitation range

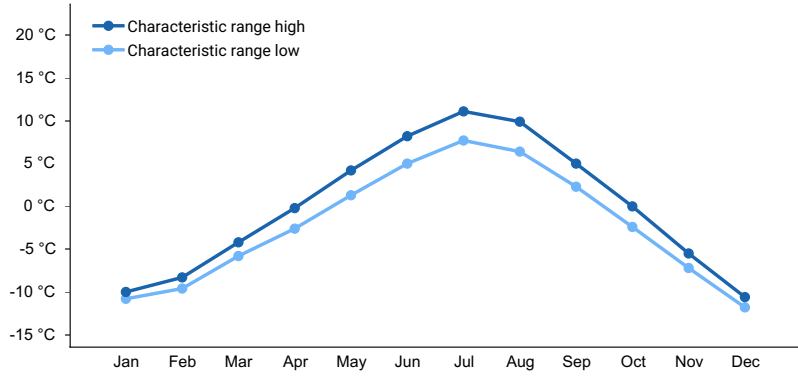

Figure 2. Monthly minimum temperature range

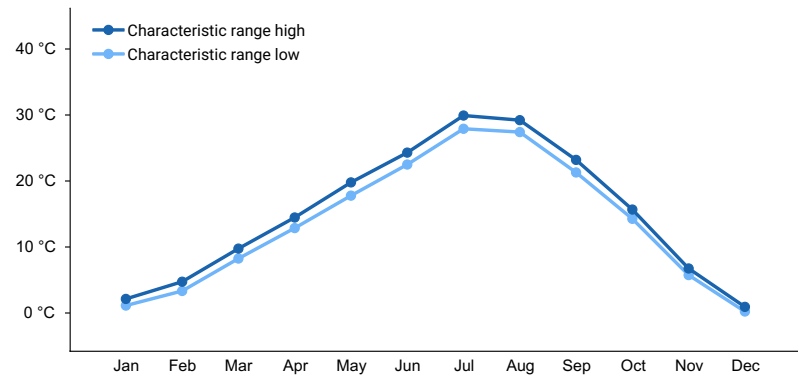

Figure 3. Monthly maximum temperature range

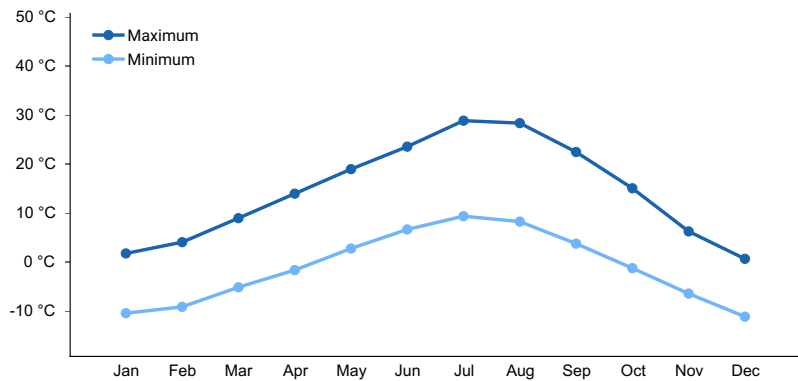

Figure 4. Monthly average minimum and maximum temperature

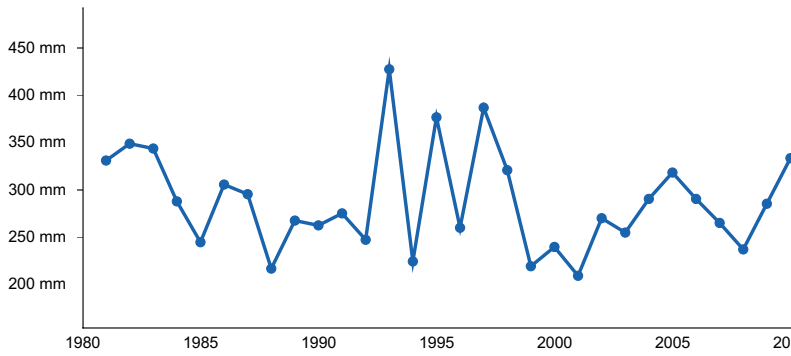

Figure 5. Annual precipitation pattern

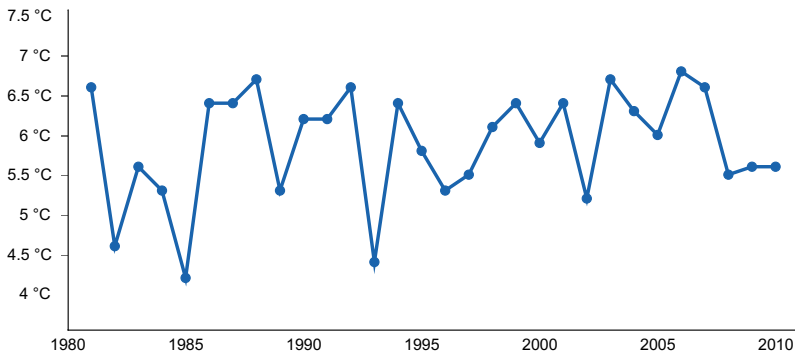

Figure 6. Annual average temperature pattern

Climate stations used

- (1) DEER LODGE 3 W [USC00242275], Deer Lodge, MT
- (2) DILLION U OF MONTANA WESTERN [USC00242409], Dillon, MT
- (3) GLEN 2 E [USC00243570], Dillon, MT
- (4) ENNIS [USC00242793], Ennis, MT
- (5) BOULDER [USC00241008], Boulder, MT
- (6) GARDINER [USC00243378], Gardiner, MT
- (7) TOWNSEND [USC00248324], Townsend, MT
- (8) TRIDENT [USC00248363], Three Forks, MT
- (9) TWIN BRIDGES [USC00248430], Sheridan, MT
- (10) WHITE SULPHUR SPRNGS 2 [USC00248930], White Sulphur Springs, MT
- (11) DILLON AP [USW00024138], Dillon, MT
- (12) HELENA RGNL AP [USW00024144], Helena, MT

Influencing water features

The Clayey Ecological Site is an upland site and is not influenced by water features.

Wetland description

Wetland features do not apply to this ecological site.

Soil features

The soils are moderately deep to very deep, have moderately slow to moderate permeability, and are well drained. The soils are formed from mixed geology alluvium or slope alluvium. Soil surface textures are silty clay loam and clay loam textures. Clay content is 32 to 45 percent of the mineral surface of 4 inches (10 cm). Common soil series in this ecological site include Sappington, Doolittle, and Dyce. Although representative of this site, these soils may exist across multiple ecological sites because of naturally variable slope, texture, rock fragments, and pH. An on-site soil pit and the most current ecological site key are necessary to classify a site.

Table 5. Representative soil features

Parent material	(1) Alluvium–igneous, metamorphic and sedimentary rock (2) Slope alluvium–igneous, metamorphic and sedimentary rock
Surface texture	(1) Clay loam (2) Silty clay loam
Family particle size	(1) Fine
Drainage class	Well drained
Permeability class	Very slow to moderate
Depth to restrictive layer	102 cm
Soil depth	152 cm
Surface fragment cover <=3"	0–20%
Surface fragment cover >3"	0–5%
Available water capacity (0-101.6cm)	12.7–17.78 cm
Calcium carbonate equivalent (0-101.6cm)	0–15%
Electrical conductivity (0-101.6cm)	0–1 mmhos/cm
Sodium adsorption ratio (0-101.6cm)	0–4
Soil reaction (1:1 water) (0-101.6cm)	6.5–8.2
Subsurface fragment volume <=3" (25.4-50.8cm)	0–15%
Subsurface fragment volume >3" (25.4-50.8cm)	0–5%

Ecological dynamics

The Clayey Ecological Site occurs in a relatively small landscape. However, slight variations within the plant community may exist due to elevation, frost-free days, and relative effective annual precipitation. Bluebunch wheatgrass (*Pseudoroegneria spicata*), for example, occupies most known combinations of elevation and climate. However, it often shares dominance with needle and thread (*Hesperostipa comata*) under a drier moisture regime. These warmer, drier sites also exhibit larger populations of warm-season shortgrass, such as blue grama (*Bouteloua gracilis*).

The reference plant community is dominated by bluebunch wheatgrass (*Pseudoroegneria spicata*), needle and thread (*Hesperostipa comata*), and green needlegrass (*Nassella viridula*). Subdominant species may include western wheatgrass (*Pascopyrum smithii*), Wyoming big sagebrush (*Artemisia tridentata* ssp. *wyomingensis*), winterfat (*Krascheninnikovia lanata*), and dotted gayfeather (*Liatris punctata*). Investigations showed a predominance of perennial grasses on near-pristine range sites (Ross et al., 1973). Shrubs comprise 10 to 15 percent of the community in the Reference State. This shrub percentage tends to be higher than many other ecological sites in this MLRA.

Historically, natural fire was a major ecological driver of this entire ecological site. Fire typically restricted tree and sagebrush growth to small patches, promoting a herbaceous plant community. The natural fire return interval was highly variable (up to 100 years) but was likely shorter than 35 years (Arno and Gruell, 1982). Sagebrush and trees have increased significantly with recent fire suppression.

Shrub dominance may occur in response to improper grazing management, drought, or where big sagebrush increases from a lack of fire. Shrub encroachment by a variety of species, including broom snakeweed (*Gutierrezia sarothrae*), prairie sagewort (*Artemisia frigida*), Wyoming big sagebrush (*Artemisia tridentata* ssp. *wyomingensis*),

rubber rabbitbrush (*Ericameria nauseosa*), yellow rabbitbrush (*Chrysothamnus viscidiflorus*), and plains prickly pear (*Opuntia polyacantha*) occurs within this site as the mid-stature bunchgrasses decrease. Shrub dominance and grass loss are associated with soil erosion and, ultimately, thinning of the native soil surface. Subsequent loss of soil could lead to a Degraded State. All states could also lead to the Invaded State when weed prevention and control measures are lacking.

Historical records indicate that elk and bison grazed this ecological site before the introduction of livestock (cattle and sheep) during the late 1800s. Due to bison's nomadic nature and herd structure, grazed areas received periodic grazing pressure. Forage for livestock was noted as minimal in areas recently grazed by bison, suggesting high-intensity grazing utilization (Lesica and Cooper, 1997).

Meriwether Lewis documented that 60 Shoshone warriors met him on horseback in August 1805. The Corps of Discovery was later supplied with horses by the same band of Shoshone. This number of horses suggests that the areas near the modern-day Montana towns of Twin Bridges, Dillon, Grant, and Dell were grazed by an unknown number of horses for nearly 50 years before the large introduction of cattle and sheep. Livestock grazing has occurred on this ecological site for more than 150 years. The gold boom in the 1860s brought the first herds of livestock overland from Texas, and homesteaders began settling the area. During this time, cattle were the primary domestic grazers in the area. In the 1890s, sheep production increased by over 400 percent and dominated the livestock industry until the 1930s. Since the 1930s, cattle production has dominated the livestock industry in the region (Hansen and Wyckoff, 1991).

Because the neutral to slightly alkaline pH of the soils on this site, the potential for dryland farming is high. Hay and small grain production have been the dominant crops to replace native vegetation on this site. Cool-season annual crops (wheat, barley, and oats), perennial introduced grass species, and legumes (e.g., alfalfa) are best adapted. This ecological site has also been converted to pastureland, typically with perennial grasses and legumes for grazing. Cropland, pastureland, and hayland are intensively managed with annual cultivation and harvesting. The use of herbicides, pesticides, and commercial fertilizers is intended to increase production. Where irrigation water is available, this site is highly productive.

Lesser spikemoss (*Selaginella densa*) is a minor component of the reference plant community. The conditions that created extensive cover classes of clubmoss on this site point to a history of continuous (yearlong) or moderate spring grazing use (Sturm, 1954). Lesser spikemoss helps reduce erosion and increase site stability. Although lesser spikemoss provides soil stability, anecdotal observations suggest that it competes for the limited water resources in the upper soil profile. This competition restricts plant available water. However a study in a similar climate on similar soils indicates that the correlation between reduced plant available water and clubmoss cover is negligible (Colberg and Romo, 2003). The correlation between reduced plant production may only be competition for space, though quantitative evidence of that theory is currently unavailable. Dense patches of spikemoss may inhibit seed contact with soil, reducing seedling recruitment.

Some of the major invasive species that can be present on this site include (but are not limited to) spotted knapweed (*Centaurea stoebe*), leafy spurge (*Euphorbia esula*), sulphur cinquefoil (*Potentilla recta*), and cheatgrass (*Bromus tectorum*), field brome (*Bromus arvensis*), butter and eggs (also known as yellow toadflax) (*Linaria vulgaris*), dandelion (*Taraxacum* spp.), Kentucky bluegrass (*Poa pratensis*). Invasive weeds begin to highly impact this ecological site under grazing mismanagement and urban development.

Plant Communities and Transitions

A state-and-transition model (STM) is depicted below. Thorough descriptions of each state, transition, plant community, and pathway follow the model. This model is based on available experimental research, field data, field observations, and interpretations by experts. It is likely to change as knowledge increases.

The plant communities within this ecological site will differ slightly across the MLRA due to the naturally occurring weather, soils, and aspect variability. The biological processes on this site are complex; therefore, representative values are presented in a land management context. The species lists are representative and are not full botanical descriptions of all species occurring or potentially occurring on this site. They are intended to cover the core species and the known range of conditions and responses.

Although considerable qualitative experience supports the pathways and transitions within the STM, no quantitative information specifically identifies threshold parameters between grassland types and invaded types in this

ecological site.

State and transition model

Land uses

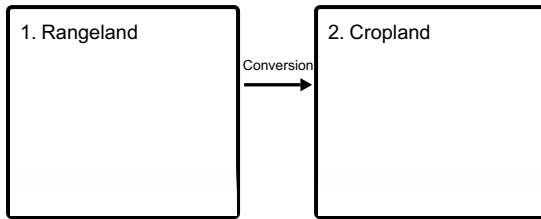

Land use 1 submodel, ecosystem states

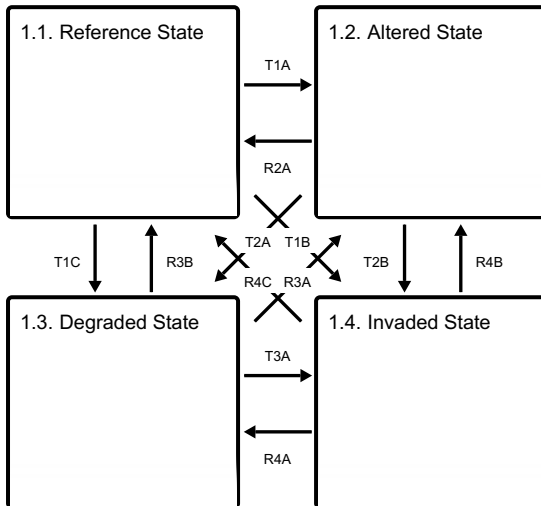

State 1 submodel, plant communities

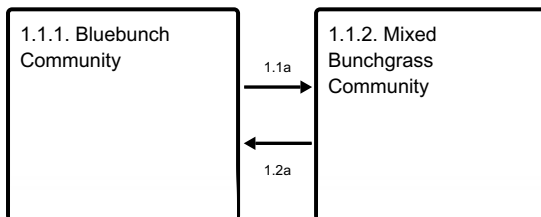

State 2 submodel, plant communities

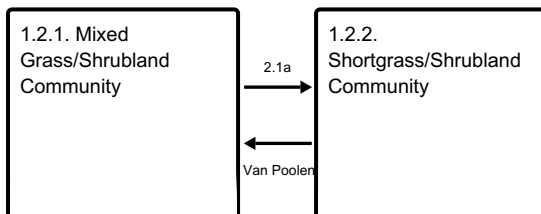

State 3 submodel, plant communities

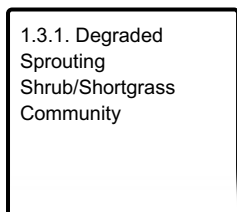

State 4 submodel, plant communities

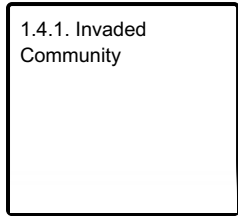

Land use 2 submodel, ecosystem states

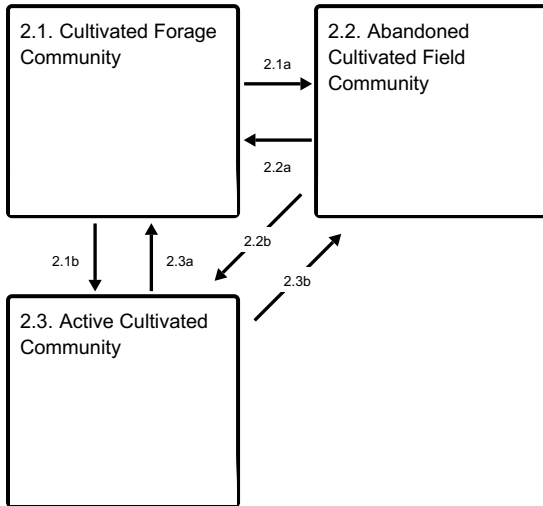

Land use 1 Rangeland

Native plant communities exist on the landscape and are often grazed by domestic livestock and wildlife. This system is dominated by native grasses, forbs, and shrubs.

State 1.1 Reference State

The Reference State of this ecological site consists of two known potential plant communities, the Bluebunch Community (1.1) and the Mixed Bunchgrass Community (1.2). These are described below but are generally characterized by a mid-statured, cool season grass community with limited shrub production. Community 1.1 is dominated by bluebunch wheatgrass and is considered the reference, while Community 1.2 has a codominance of bluebunch, needle and thread, and western wheatgrass with an increase in forbs and Wyoming big sagebrush.

Community 1.1.1 Bluebunch Community

In this community, bluebunch wheatgrass (*Pseudoroegneria spicata*), green needlegrass (*Nassella viridula*), and needle and thread (*Hesperostipa comata*) are dominant. Shrub species (big sagebrush, prairie sagewort, and broom snakeweed) remain a subdominant component of this site. Sandberg bluegrass (*Poa secunda*) and dryland sedges are also common. This state is in areas with proper livestock grazing or little grazing pressure. Bluebunch wheatgrass lacks resistance to grazing during the critical growing season (spring). It will decline in vigor and production if grazed in the critical growing season for more than one year in three (Wilson et al., 1960). The Bluebunch Community is moderately resilient. It will return to dynamic equilibrium following a relatively short period of stress (such as drought or short-term improper grazing), provided a return of favorable or normal growing conditions and properly managed grazing. As discussed in the Ecological Dynamics section, the natural fire regime restricted shrubs in this Bluebunch Community 1.1.1. Shrub species may include Wyoming big sagebrush, winterfat, tarragon (*Artemisia dracunculus*), and prairie sagewort (*Artemisia frigida*). Infrequent fire maintained big sagebrush communities as open, seral stands of productive herbaceous species with patches of big sagebrush.

Resilience management. Prescribed grazing; prescribed burning; brush management; pest management.

Dominant plant species

- big sagebrush (*Artemisia tridentata*), shrub
- winterfat (*Krascheninnikovia lanata*), shrub
- bluebunch wheatgrass (*Pseudoroegneria spicata*), grass
- green needlegrass (*Nassella viridula*), grass
- western wheatgrass (*Pascopyrum smithii*), grass
- Sandberg bluegrass (*Poa secunda*), grass

Table 6. Annual production by plant type

Plant Type	Low (Kg/Hectare)	Representative Value (Kg/Hectare)	High (Kg/Hectare)
Grass/Grasslike	852	1143	1524
Shrub/Vine	159	194	286
Forb	54	64	95
Total	1065	1401	1905

Table 7. Ground cover

Tree foliar cover	0%
Shrub/vine/liana foliar cover	5-10%
Grass/grasslike foliar cover	55-70%
Forb foliar cover	1-10%
Non-vascular plants	0%
Biological crusts	0-3%
Litter	0%
Surface fragments >0.25" and <=3"	0%
Surface fragments >3"	0%
Bedrock	0%
Water	0%
Bare ground	0%

Table 8. Soil surface cover

Tree basal cover	0%
Shrub/vine/liana basal cover	0%
Grass/grasslike basal cover	0%
Forb basal cover	0%
Non-vascular plants	0%
Biological crusts	0-3%
Litter	35-65%
Surface fragments >0.25" and <=3"	0-5%
Surface fragments >3"	0-5%
Bedrock	0%
Water	0%
Bare ground	15-20%

Table 9. Woody ground cover

Downed wood, fine-small (<0.40" diameter; 1-hour fuels)	0-2% N*
Downed wood, fine-medium (0.40-0.99" diameter; 10-hour fuels)	—
Downed wood, fine-large (1.00-2.99" diameter; 100-hour fuels)	—
Downed wood, coarse-small (3.00-8.99" diameter; 1,000-hour fuels)	—
Downed wood, coarse-large (>9.00" diameter; 10,000-hour fuels)	—
Tree snags** (hard***)	—
Tree snags** (soft***)	—
Tree snag count** (hard***)	
Tree snag count** (hard***)	

* **Decomposition Classes:** N - no or little integration with the soil surface; I - partial to nearly full integration with the soil surface.

** >10.16cm diameter at 1.3716m above ground and >1.8288m height--if less diameter OR height use applicable down wood type; for pinyon and juniper, use 0.3048m above ground.

*** **Hard** - tree is dead with most or all of bark intact; **Soft** - most of bark has sloughed off.

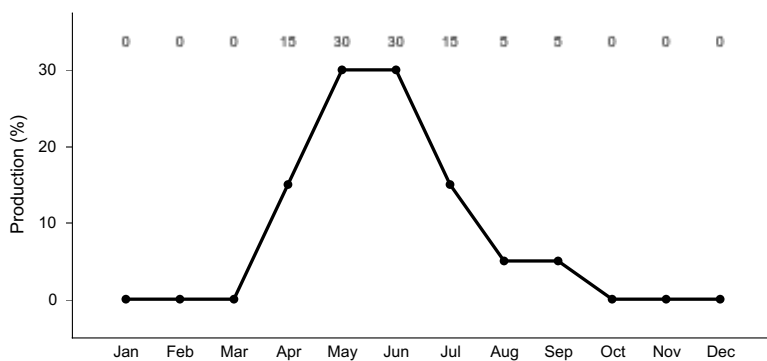

Figure 8. Plant community growth curve (percent production by month). MT44B032, Dry Uplands. Cool season grass dominated system. Most dry, upland sites located within MLRA 44B LRU A are characterized by early season growth which is mostly complete by Mid-July. Limited fall "green-up" if conditions allow..

Community 1.1.2 Mixed Bunchgrass Community

Western wheatgrass tolerates grazing pressure better than bluebunch wheatgrass and green needlegrass. The growing point for bluebunch wheatgrass grass is several inches above the ground, making it very susceptible to continued close grazing (Smoliack et al., 2006), while western wheatgrass growing points tend to be near the plant base. Western wheatgrass and Sandberg bluegrass increase in species composition when more palatable and less grazing-tolerant plants decrease from improper grazing management. Western wheatgrass and bluebunch wheatgrass share dominance in the Mixed Bunchgrass Community (1.1.2), with green needlegrass subdominant. Other grazing-tolerant grass species are likely to increase in number compared to the Bluebunch Community, including Sandberg bluegrass (*Poa secunda*), prairie Junegrass, and blue grama (*Bouteloua gracilis*). Western yarrow (*Achillea millefolium* var. *occidentalis*), spiny phlox (*Phlox hoodii*), scarlet globemallow (*Sphaeralcea coccinea*), hairy false goldenaster (*Heterotheca villosa*), and pussytoes (*Antennaria* spp.) are examples of increaser forbs. Prairie sagewort (*Artemisia frigida*) is a shrub that increases under prolonged drought or heavy grazing and can respond to precipitation in July and August. Heavy, continuous grazing will reduce plant cover, litter, and mulch. The timing of grazing is important on this site because of the moisture limitations beyond June, especially on the drier sites. The bare ground will increase, exposing the soil to erosion. Litter and mulch will be reduced as plant cover declines. If bluebunch wheatgrass remains a dominant species in total biomass production, the site can return to the Bluebunch Community (Pathway 1.2a) under proper grazing management and favorable growing conditions. Western wheatgrass will continue to increase until it makes up the majority of the species composition. It may be difficult for the site to recover to the Bluebunch Community (1.1.1) once bluebunch wheatgrass has been reduced to less than 15 percent by weight. The risk of soil erosion increases when canopy cover decreases. As soil conditions degrade, there will be a loss of organic matter, reduced litter, and reduced soil fertility. Degraded soil conditions increase the difficulty of reestablishing bluebunch wheatgrass and returning to the reference community (1.1.1). The Mixed Bunchgrass Community (1.1.2) is the at-risk plant community for this ecological site. When overgrazing

continues, increaser species such as needle and thread and native forb species will become more dominant, and this triggers the change to the Altered State (1.2) or the Degraded State (1.3). Until the Mixed Bunchgrass Community (1.1.2) crosses the threshold into the Mixed Grass/Shrubland Community (1.2.1) or the Invaded Community (1.4.1), community 1.1.2 can be managed toward the Bluebunch Community (1.1.1) using prescribed grazing and strategic weed control. It may take several years to achieve this recovery, depending on growing conditions, the vigor of remnant bluebunch wheatgrass plants, and the aggressiveness of the weed treatments.

Resilience management. Prescribed Grazing; brush management; pest management; prescribed fire.

Dominant plant species

- big sagebrush (*Artemisia tridentata*), shrub
- winterfat (*Krascheninnikovia lanata*), shrub
- rubber rabbitbrush (*Ericameria nauseosa*), shrub
- yellow rabbitbrush (*Chrysothamnus viscidiflorus*), shrub
- needle and thread (*Hesperostipa comata*), grass
- bluebunch wheatgrass (*Pseudoroegneria spicata*), grass

Pathway 1.1a

Community 1.1.1 to 1.1.2

Bluebunch wheatgrass loses vigor with improper grazing or extended drought. When vigor declines enough for plants to die or become smaller, species with higher grazing tolerance, such as needle and thread, increase in vigor and production as they access the resources previously used by bluebunch wheatgrass. The decrease in species composition by weight of bluebunch wheatgrass to less than 50 percent indicates that the plant community has shifted to the Mixed Bunchgrass Community (1.1.2). The driver for community shift 1.1a is improper grazing management or prolonged drought. This shift is triggered by the loss of vigor of bluebunch wheatgrass, soil erosion, or prolonged drought coupled with improper grazing. Drought and warmer than average temperatures are known to advance plant phenology by as much as one month (Blaisdell, 1958). During drought years, plants may be especially sensitive or in a critical stage of development earlier than expected.

Pathway 1.2a

Community 1.1.2 to 1.1.1

The Mixed Bunchgrass Community (1.1.2) will return to the Bluebunch Community (1.1.1) with proper grazing management and appropriate grazing intensity. Favorable moisture conditions will facilitate or accelerate this transition. It may take several years of favorable conditions for the community to transition back to a bluebunch-dominated community. The driver for this community shift (1.2a) is the increased vigor of bluebunch wheatgrass, representing more than 50 percent of the species composition. The trigger for this shift is the change in grazing management favoring bluebunch wheatgrass. In general, these triggers include conservative grazing management styles such as deferred or rest rotations utilizing moderate grazing (less than 50 percent grazing use) coupled with favorable growing conditions like cool, wet springs. These systems tend to promote increases in soil organic matter, which supports microfauna and can increase infiltration rates. Inversely, long periods of rest when this state is considered stable may not increase bluebunch wheatgrass. It has been suggested that these long periods of rest or underutilization may drive the system to a lower level of stability by creating large amounts of standing biomass, dead plant caudex centers, and gaps in the plant canopy (Noy-Meir, 1973).

Conservation practices

Prescribed Burning
Prescribed Grazing

State 1.2

Altered State

This state is characterized by having less than 15 percent bluebunch wheatgrass by dry weight. This state is represented by two communities that differ in the percent composition of needle and thread, production, and soil degradation. Production in this state can be similar to that in the Reference State (1.1). Some native plants increase

with prolonged drought, heavy grazing practices, or both. These species may include western wheatgrass, needle and thread, Sandberg bluegrass, scarlet globemallow, hairy false goldenaster, and prairie sagewort.

Characteristics and indicators. Less than 15 percent bluebunch wheatgrass; increase in short stature grasses; increase in bare ground.

Resilience management. Conservative grazing management; integrated pest management; time.

Dominant plant species

- big sagebrush (*Artemisia tridentata*), shrub
- yellow rabbitbrush (*Chrysothamnus viscidiflorus*), shrub
- broom snakeweed (*Gutierrezia sarothrae*), shrub
- rubber rabbitbrush (*Ericameria nauseosa*), shrub
- needle and thread (*Hesperostipa comata*), grass
- Sandberg bluegrass (*Poa secunda*), grass
- prairie Junegrass (*Koeleria macrantha*), grass
- bluebunch wheatgrass (*Pseudoroegneria spicata*), grass

Community 1.2.1

Mixed Grass/Shrubland Community

Long-term grazing mismanagement with continuous growing-season pressure will reduce the total productivity of the site and lead to an increase in bare ground. Suppression of fire can also promote shrub growth, increasing plant interspaces. Once plant cover is reduced, the site is more susceptible to erosion and degradation of soil properties. Soil erosion or reduced soil fertility will result in reduced plant production. This soil erosion or loss of soil fertility indicates the transition to the Altered State (1.2) because it creates a threshold requiring energy input to return to the Reference State (1.1). Extended drought conditions may exacerbate the transition to the Mixed Grass/Shrubland Community (1.2.1). Western wheatgrass dominates the Mixed Grass/Shrubland Community (1.2.1). Bluebunch wheatgrass makes up less than 15 percent of species composition by dry weight, and the remaining bluebunch wheatgrass plants tend to be scattered and low in vigor. Invasive and increaser species will become more common. Hairy false goldenaster, Missouri goldenrod (*Solidago missouriensis*), stonecrop (*Sedum* sp.), and yarrow are examples of increaser forbs. It is not uncommon for a minor component of invader species, such as dandelion and yellow salsify (*Tragopogon dubius*), to be present. The presence of invader species creates more competition for bluebunch wheatgrass and makes it difficult for bluebunch wheatgrass to respond quickly to a change in grazing management alone. Therefore, an input of energy is required for the community to return to the Reference State (1.1). Wind and water erosion may be eroding soil from the plant interspaces. Soil fertility is reduced, and soil surface erosion resistance has declined compared to the Reference State (1.1). This community crossed a threshold compared to the Mixed Bunchgrass Community (1.1.2) due to soil erosion, vegetation composition, loss of soil fertility, or degradation of soil conditions. These factors result in a critical shift in the ecology of the site. The effects of soil erosion can alter the hydrology, soil chemistry, soil microorganisms, and soil structure to the point where intensive restoration is required to restore the site to another state or community. Changing grazing management alone cannot create sufficient improvement to restore the site within a reasonable time frame. A study stated that with decreased grazing pressure, a needle and thread and blue grama plant community did not change species composition, but the content of the soil carbon increased (Dormaar et al., 1997). It will require considerable energy to move the site back to the Reference State (1.1). This state has lost soil or vegetation attributes to the point that recovery to the Reference State (1.1) will require reclamation efforts, i.e., soil rebuilding, intensive mechanical treatments, reseeding, or all reclamation efforts. The transition to this state could result from overgrazing and fire suppression, especially repeated early-season grazing coupled with extensive drought. If heavy grazing continues, plant cover, litter, and mulch will continue to decrease, and bare ground will increase, exposing the soil to accelerated erosion. Litter and mulch will move off-site as plant cover declines. The Mixed Grass/Shrubland Community will then shift to a Shortgrass/Shrub Community (1.2.2). Continued improper grazing will drive the community to a Degraded State (1.3). The introduction or expansion of invasive species will further transition the plant community into the Invaded State (1.4).

Dominant plant species

- big sagebrush (*Artemisia tridentata*), shrub
- yellow rabbitbrush (*Chrysothamnus viscidiflorus*), shrub

- rubber rabbitbrush (*Ericameria nauseosa*), shrub
- broom snakeweed (*Gutierrezia sarothrae*), shrub
- western wheatgrass (*Pascopyrum smithii*), grass
- Sandberg bluegrass (*Poa secunda*), grass
- bluebunch wheatgrass (*Pseudoroegneria spicata*), grass
- prairie Junegrass (*Koeleria macrantha*), grass

Community 1.2.2 Shortgrass/Shrubland Community

With continued mismanagement of grazing, especially with prolonged drought, mid-statured bunchgrasses will decline in production as plants become smaller. Species with higher grazing tolerance (such as western wheatgrass and prairie Junegrass) increase in vigor and production as they respond to resources previously used by the bunchgrasses. These less desirable, shallow-rooted species will become co-dominant with the bunchgrasses. Shrubs will become more competitive for limited moisture as bare ground and soil erosion increase. This community may exhibit conditions where livestock are consuming shrubs.

Dominant plant species

- broom snakeweed (*Gutierrezia sarothrae*), shrub
- yellow rabbitbrush (*Chrysothamnus viscidiflorus*), shrub
- rubber rabbitbrush (*Ericameria nauseosa*), shrub
- big sagebrush (*Artemisia tridentata*), shrub
- needle and thread (*Hesperostipa comata*), grass
- Sandberg bluegrass (*Poa secunda*), grass
- prairie Junegrass (*Koeleria macrantha*), grass
- bluebunch wheatgrass (*Pseudoroegneria spicata*), grass

Pathway 2.1a Community 1.2.1 to 1.2.2

The driver for community Pathway shift 2.1a is continued improper grazing management. This shift is triggered by the continued loss of bunchgrass vigor, especially needle and thread. The short-statured grasses will become more competitive and will become co-dominant with the bunchgrasses. Shrubs will increase in canopy cover; however, they may be browsed, resulting in spreading formations.

Pathway (Lacey and Van Poolen, 1979)2.2a Community 1.2.2 to 1.2.1

If proper grazing management is implemented, western wheatgrass and bluebunch wheatgrass may regain their vigor and move toward the Mixed Grass/Shrubland Community (1.2.1). Increased bunchgrass vigor will give grasses an advantage over invading shrubs. The advantage to grasses comes from following a conservative grazing plan where utilization is reduced, and rest or deferment is incorporated since the transition from community 1.2.1 to community 1.2.2 is likely caused by repeated heavy utilization. A study found that forage production increased by an average of 35 percent on western ranges when converting heavy to moderate utilization (Wambolt and Payne, 1986). Shrub removal and favorable growing conditions can accelerate this process. If the site contains Wyoming big sagebrush (*Artemisia tridentata* ssp. *wyomingensis*), low-intensity fire or mechanical treatment could reduce shrub competition and allow for increased vigor and the reestablishment of grass species (Wambolt and Payne, 1986; Personius et al., 1987).

Conservation practices

Brush Management
Prescribed Burning
Prescribed Grazing

State 1.3

Degraded State

The Degraded State lacks mid-statured bunchgrasses. Western wheatgrass, blue grama, Sandberg bluegrass, and prairie Junegrass are dominant grasses. Broom snakeweed and prickly pear cactus have nearly replaced larger shrub species. Larger shrub species that remain are heavily hedged. This condition is likely a terminal state (e.g., restoration will likely be impossible or require major energy inputs beyond feasibility).

Characteristics and indicators. 25 to 50 percent bare ground, annual grasses, and cactus are common. Complete removal of bluebunch wheatgrass and green needlegrass. Replaced with Sandberg bluegrass, western wheatgrass, and blue grama. Sagebrush is hedged. Rabbitbrush and broom snakeweed remain un-browsed.

Resilience management. Prescribed grazing; range seeding; brush management; integrated pest management.

Dominant plant species

- broom snakeweed (*Gutierrezia sarothrae*), shrub
- yellow rabbitbrush (*Chrysothamnus viscidiflorus*), shrub
- rubber rabbitbrush (*Ericameria nauseosa*), shrub
- plains pricklypear (*Opuntia polyacantha*), shrub
- Sandberg bluegrass (*Poa secunda*), grass
- blue grama (*Bouteloua gracilis*), grass
- prairie Junegrass (*Koeleria macrantha*), grass
- sixweeks fescue (*Vulpia octoflora*), grass
- needle and thread (*Hesperostipa comata*), grass

Community 1.3.1

Degraded Sprouting Shrub/Shortgrass Community

The Degraded Sprouting Shrub/Shortgrass Community is dominated by short shrubs that sprout from animals browsing. Prairie sagewort, broom snakeweed, and rubber rabbitbrush are often dominant species, with shortgrass subdominant. Grasses often express a decumbent or prostrate growth habit. Needle and thread will have short leaves and express small basal areas. This site will have high bare ground and likely exhibit signs of erosion, with water flow patterns and pedestalling common, especially on steeper slopes. The complete removal of mid-statured bunchgrasses makes restoration nearly impossible. Reduced organic matter in the soil will hinder any restoration efforts.

State 1.4

Invaded State

The Invaded State is identified as being in the exponential growth phase of invader abundance, where control is a priority. Dominance (or relative dominance) of noxious or invasive species reduces species diversity, forage production, wildlife habitat, and site protection. A level of 20 percent invasive species composition by dry weight indicates that a substantial energy input will be required to create a shift to the grassland state (herbicide, mechanical treatment), even with a return to proper grazing management or favorable growing conditions. Prescriptive grazing can be used to manage invasive species. In some instances, carefully targeted grazing (sometimes in combination with other treatments) can reduce or maintain the species composition of invasive species.

Characteristics and indicators. High amounts of invading species (both native and introduced).

Resilience management. Integrated pest management; prescribed grazing; brush management; prescribed fire; range seeding

Community 1.4.1

Invaded Community

Communities in this state may be structurally indistinguishable from the bunchgrass state except that invasive or

noxious species exceed 20 percent of species composition by dry weight. This state may also include a community similar to the Degraded Shortgrass State (1.3), except that invasive or noxious species exceed 20 percent of species composition by dry weight. Although there is no research to document the level of 20 percent, this is estimated to be the point in the invasion process following the lag phase based on the interpretation of Masters and Sheley (2001). The threshold for aggressive invasive species (i.e., spotted knapweed), could be less than 10 percent. Early in the invasion process, there is a lag phase where the invasive plant populations remain small and localized for long periods before expanding exponentially (Hobbs and Humphries, 1995). Production in the invaded community may vary greatly. For example, a site with Kentucky bluegrass or spotted knapweed may have production near the reference community. A site with degraded soils and an infestation of cheatgrass may produce only 10 to 20 percent of the reference community. The Invaded State (1.4) is reached when invasive species dominate the site, by species composition by weight, or their impact on the community. As invasive species such as spotted knapweed, cheatgrass, and leafy spurge become established, they become very difficult to eradicate. Therefore, considerable effort should be put into preventing plant communities from crossing a threshold into the Invaded State (1.4) through early detection and proper management. Preventing new invasions is the most cost-effective control strategy and typically emphasizes education. Control measures used on the noxious plant species impacting this ecological site include chemical, biological, and cultural control methods. The best success has been found with an integrated pest management (IPM) strategy incorporating one or several options and education and prevention efforts (DiTomaso, 2000).

Transition T1A **State 1.1 to 1.2**

The Reference State (1.1) transitions to the Altered State (1.2) if bluebunch wheatgrass, by dry weight, decreases to below 15 percent or if bare ground cover increases significantly. The driver for this transition is the loss of taller bunchgrasses, which creates open areas in the plant canopy with bare soil. Soil erosion results in decreased soil fertility, driving transitions to the Altered State. Several other key factors signal the approach of transition T1A: increases in soil physical crusting, decreases in cover of cryptogamic crusts, decreases in soil surface aggregate stability, or evidence of erosion including water flow patterns, development of plant pedestals, and litter movement. The trigger for this transition is improper grazing management, long-term drought, or both, leading to a decrease in bluebunch wheatgrass composition to less than 15 percent and a reduction in total plant canopy cover.

Conservation practices

Brush Management
Prescribed Burning
Prescribed Grazing

Transition T1C **State 1.1 to 1.3**

The Reference State (1.1) transitions to the Degraded State (1.3) when bluebunch wheatgrass is removed from the plant community and needle and thread is subdominant to short-statured bunchgrasses such as Sandberg bluegrass. The trigger for this transition is the loss of taller bunchgrasses, which creates open spaces with bare soil. Soil erosion results in decreased soil fertility, driving transitions to the Degraded State. Several other key factors signal the approach of transition T1C: increases in soil physical crusting, decreases in the cover of biological crusts, decreases in soil surface aggregate stability or evidence of erosion, including water flow patterns, the development of plant pedestals, and litter movement. The drivers for this transition are improper grazing management, intense or repeated fires, heavy human disturbance, or all three. Rapid transition is generally seen where livestock are confined to small pastures for long periods.

Transition T1B **State 1.1 to 1.4**

Healthy plant communities are most resistant to invasion. However, regardless of grazing management, without some form of active weed management (chemical, mechanical, or biological control) and without prevention, the Reference State (1.1) can transition to the Invaded State (1.4) in the presence of aggressive invasive species such as spotted knapweed, leafy spurge, and cheatgrass. The Central Rocky Mountain Valleys tend to resist invasion by

cheatgrass; however, repeated heavy grazing or intense human activities can open the interspaces of the bunchgrass community and allow for establishment. Long-term stress conditions for native species (overgrazing, drought, and fire) accelerate this transition. If populations of invasive species reach critical levels, the site transitions to the Invaded State. The trigger for this transition is the presence of aggressive invasive species. The species composition by dry weight of invasive species approaches 10 percent.

Restoration pathway R2A

State 1.2 to 1.1

The Altered State (1.2) has lost enough soil or vegetation attributes that recovery to the Reference State (1.1) will require reclamation efforts such as soil rebuilding, intensive mechanical and cultural treatments, revegetation, or all three. Examples of mechanical treatment may be brush control, while cultural treatments may include prescribed grazing, targeted brush browsing, or prescribed burning. Low-intensity prescribed fires to reduce competitive increaser plants such as needle and thread and Sandberg bluegrass. A low-intensity fire will also reduce Wyoming big sagebrush densities. Fire should be carefully planned or avoided in areas prone to annual grass infestation. The drivers for this restoration pathway are reclamation efforts along with proper grazing management.

Conservation practices

Brush Management
Prescribed Burning
Fence
Livestock Pipeline
Grazing Land Mechanical Treatment
Range Planting
Prescribed Grazing

Transition T2A

State 1.2 to 1.3

As improper grazing management continues, the vigor of bunchgrasses will decrease and the shorter grasses and shrubs will increase, leading to the Degraded State (1.3). Prolonged drought will provide a competitive advantage to shrubs, allowing them to co-dominate with grasses. The shrub canopy will increase. Key transition factors include: an increase in native shrub canopy cover; a reduction in bunchgrass production; a decrease in total plant canopy cover and production; increases in mean bare patch size; increases in soil crusting; decreases in the cover of biotic crusts; decreases in soil aggregate stability; and evidence of erosion, including water flow patterns and litter movement.

Transition T2B

State 1.2 to 1.4

Invasive species can occupy the Altered State (1.2) and drive it to the Invaded State (1.4). The Altered State is at risk if invasive seeds or other viable material are present. The driver for this transition is invasive species, which make up more than 20 percent of the dry weight. The trigger is the presence of seeds or other viable material from invasive species.

Restoration pathway R3B

State 1.3 to 1.1

The Degraded State (1.3) has lost enough soil or vegetation attributes that recovery to the Reference State (1.1) will require reclamation efforts, such as soil rebuilding, intensive mechanical treatments, revegetation, or all three. Mulch with a high carbon to nitrogen ratio, such as wood chips or bark, in low moisture scenarios can be beneficial for slow mobilization of plant nitrogen (Whitford et al., 1989). Biochar may also be added to the system to improve soil organic carbon (SOC) which should improve cation exchange capacity (CEC), microbial activity, and hydrologic conductivity (Stavi, 2012). The drivers for the restoration pathway are the removal of increaser species, restoration

of native bunchgrass species, persistent management of invasives and shrubs, and proper grazing management. Without continued control, invasive and shrub species are likely to return (probably rapidly) due to presence of seeds or other viable material in the soil and management related increases soil disturbance.

Conservation practices

Brush Management
Prescribed Burning
Fence
Grazing Land Mechanical Treatment
Range Planting
Prescribed Grazing

Restoration pathway R3A

State 1.3 to 1.2

Since the bunchgrass plant community has been significantly reduced, restoration to the Altered State (1.2) is unlikely unless a seed source is available. If enough grass remains on the site, chemical or biological control, combined with proper grazing management, can reduce the amount of shrubs and invasive species and restore the site to the Shortgrass Community (1.2.2). Low-intensity fire can be utilized to reduce Wyoming big sagebrush competition and allow the reestablishment of grass species. Caution must be used when considering fire as a management tool on sites with fire tolerant shrubs, such as rubber rabbitbrush, as these shrubs will sprout after a burn. Broom snakeweed and prairie sagewort may or may not re-sprout depending on conditions.

Conservation practices

Brush Management
Prescribed Burning
Range Planting
Integrated Pest Management (IPM)
Prescribed Grazing

Transition T3A

State 1.3 to 1.4

Invasive species can occupy the Degraded State (1.3) and drive it to the Invaded State (1.4). The Degraded State is at risk of this transition occurring if invasive seeds or viable material are present. The driver for this transition is the presence of critical population levels of invasive species. The trigger is the presence of seeds or viable material from invasive species. This state has sufficient bare ground that the transition could occur simply due to the presence or introduction of invasive seeds or viable material. This is particularly true of aggressive invasive species such as spotted knapweed and cheatgrass. This transition could be assisted by overgrazing (failure to adjust stocking rate to declining forage production), a long-term lack of fire, or an extensive drought.

Restoration pathway R4C

State 1.4 to 1.1

Restoration of the Invaded State (1.4) to the Reference State (1.1) requires substantial energy input. The drivers for the restoration pathway are the removal of invasive species, restoration of native bunchgrass species, persistent management of invasive species, and proper grazing management. Without continued control, invasive species are likely to return (probably rapidly) due to the presence of seeds or other viable material in the soil and management-related practices that increase soil disturbance. If invaded by conifer encroachment, treatment depends on the condition of the rangeland. Sites that have transitioned from the Degraded State (1.3) to the Invaded State (1.4) may be severely lacking in soil and vegetative properties that will allow for restoration to the Reference State. Hydrologic function damage may be irreversible especially with accelerated gully erosion.

Conservation practices

Brush Management
Prescribed Burning
Range Planting
Integrated Pest Management (IPM)
Rangeland Fertilization
Prescribed Grazing

Restoration pathway R4B

State 1.4 to 1.2

If invasive species are removed before remnant populations of bunchgrass are drastically reduced, the Invaded State (1.4) can revert to the Altered State. The driver for the reclamation pathway is weed management without reseeding. Continued integrated pest management (IPM) will be required as many of the invasive species that can occupy the Invaded State have extended dormant seed life. The trigger is invasive species control.

Conservation practices

Brush Management
Prescribed Burning
Prescribed Grazing

Restoration pathway R4A

State 1.4 to 1.3

If invasive species are removed, the site could return to the Degraded State (1.3). Without sufficient remnant populations of preferred plants, the Invaded State (1.4) is not likely to return to any of the other states. The driver for the reclamation pathway is weed management without reseeding. The trigger is invasive species control. Due to a lack of ground cover, the invading species cause a significant increase in soil loss (Lacey et al., 1989).

Conservation practices

Brush Management
Prescribed Burning
Integrated Pest Management (IPM)
Prescribed Grazing

Land use 2

Cropland

Native rangeland has been converted for the production of forage crops or small grain products. This site often receives additional moisture from irrigation to increase production. Fertilizer and herbicides are frequently added to the Cultivated Cropland State to aid in crop production.

State 2.1

Cultivated Forage Community

The Cultivated Forage Community is the most common within the Cultivated Cropland State. It consists primarily of long-term grass, forb crops, or both planted for grazing or hay. If irrigation water is available, species will vary greatly depending on the land manager's goals and objectives but will almost certainly include alfalfa. Production from an irrigated site in this community is typically high. If irrigation is unavailable, the dry climate limits species options, which will likely include crested wheatgrass, Russian wildrye, or intermediate wheatgrass. Alfalfa is rarely a

lone species under dryland conditions.

State 2.2

Abandoned Cultivated Field Community

The Abandoned Cultivated Field Community is a relatively rare occurrence due to the productive nature of this ecological site. However, as traditional land use transitions from agriculture to recreation, abandonment of cultivation may occur. If the site were in the Actively Cultivated State at the time of abandonment, the resulting plant community would likely transition into an herbaceous annual weed community. Over time, the weeds will typically yield a naturalized community of perennial grasses and forbs sourced from the surrounding plant community. Needle and thread, blue grama, Sandberg bluegrass, rabbitbrush, and prairie sagewort are the common native species that will colonize this site. Active Cultivated Community States are rarely abandoned without some attempt to be planted in a Cultivated Forage Community first. If the site was managed as a Cultivated Forage Community at the time of abandonment, the plant community tends to transition into one that more closely resembles a Degraded State from the native rangeland condition. With enough time, native colonizing species will slowly fill the interspaces between the forage crops. Once the Abandoned Cultivated Field Community has matured, it will have very similar ecological processes to the Degraded State (1.3.1)

State 2.3

Active Cultivated Community

Active Cultivated Community is common on this ecological site as the soil pH, water holding capacity, and inherent soil organic matter tend to favor annual cropping of small grains. If irrigation is available, this community can produce a wide variety of crops, including corn silage, pumpkins, sunflowers, and other specialty crops. The relatively short growing season tends to be the restriction if irrigation is used. Long-term annual cropping can destroy soil aggregation, create soil erosion (both wind and water), deplete organic matter, and alter pH, so a conservative crop management system will need to be applied to prevent site degradation.

Transition 2.1a

State 2.1 to 2.2

The Cultivated Forage Community has been abandoned. This pathway occurs rarely in the present, but it has occurred in the past. This community 2.2 can be observed in historically farmed areas that have been abandoned for unknown reasons. The field is left idle from crop management, and over time, the surrounding native vegetation fills the interspaces between plants.

Transition 2.1b

State 2.1 to 2.3

Cultivated Forage Community is converted from permanent cover to an annually cropped system. Change takes place when cultivation or tillage occurs. This community pathway is frequent on this ecological site, particularly when the Cultivated Forage Community's production begins to drop. This often occurs on a 10 to 20 year cycle in this MLRA.

Transition 2.2a

State 2.2 to 2.1

Abandoned Cultivated Field is planted to a forage or hay crop of the manager's preference. Often, this pathway will require tillage, herbicide, or both to terminate the existing plant community and seeding to initiate change.

Transition 2.2b

State 2.2 to 2.3

An abandoned cultivated field is converted to an annually cropped system. Change takes place when cultivation or tillage occurs. This community pathway is often necessary to convert a lower-producing or undesirable community into an annually cropped system.

Transition 2.3a

State 2.3 to 2.1

Active Cultivation Community is planted to a forage or hay crop of the manager's preference. This is a common pathway in the MLRA.

Transition 2.3b

State 2.3 to 2.2

Active Community is abandoned. This pathway is rare in the present, but it has occurred frequently in the past, which is how the Abandoned Cultivated field Community 2.2 has been observed. The field is left idle from crop management. Over time, the surrounding native vegetation fills the interspaces between weedy, herbaceous plants.

Conversion Conversion

Land use 1 to 2

Native rangeland is sodbusted to grow commodity crops. This requires multiple farm implements to remove existing native vegetation to create a seedbed for small grains, hay, introduced pasture, or other commodity crops.

Additional community tables

Table 10. Community 1.1 plant community composition

Group	Common Name	Symbol	Scientific Name	Annual Production (Kg/Hectare)	Foliar Cover (%)
Grass/Grasslike					
1				745–1334	
	bluebunch wheatgrass	PSSP6	<i>Pseudoroegneria spicata</i>	504–1065	–
	green needlegrass	NAV14	<i>Nassella viridula</i>	106–336	–
	western wheatgrass	PASM	<i>Pascopyrum smithii</i>	50–191	–
	thickspike wheatgrass	ELLA3	<i>Elymus lanceolatus</i>	0–191	–
2				106–191	
	Sandberg bluegrass	POSE	<i>Poa secunda</i>	22–112	–
	plains reedgrass	CAMO	<i>Calamagrostis montanensis</i>	0–95	–
	prairie Junegrass	KOMA	<i>Koeleria macrantha</i>	0–95	–
	blue grama	BOGR2	<i>Bouteloua gracilis</i>	22–73	–
	needleleaf sedge	CADU6	<i>Carex duriuscula</i>	0–56	–
	threadleaf sedge	CAFI	<i>Carex filifolia</i>	0–56	–
	Grass-like, perennial	2GLP	<i>Grass-like, perennial</i>	0–22	–
	Grass, perennial	2GP	<i>Grass, perennial</i>	0–22	–
Forb					
3				54–95	
	American vetch	VIAM	<i>Vicia americana</i>	22–95	–
	dotted blazing star	LIPU	<i>Liatris punctata</i>	11–90	–
	hairy false goldenaster	HEV14	<i>Heterotheca villosa</i>	11–90	–
	desertparsley	LOMAT	<i>Lomatium</i>	0–56	–
	scarlet globemallow	SPCO	<i>Sphaeralcea coccinea</i>	6–45	–
	Missouri goldenrod	SOMI2	<i>Solidago missouriensis</i>	0–45	–
	bastard toadflax	COUM	<i>Comandra umbellata</i>	0–28	–
	fleabane	ERIGE2	<i>Erigeron</i>	0–22	–
	buckwheat	ERIOG	<i>Eriogonum</i>	0–22	–
	spiny phlox	PHHO	<i>Phlox hoodii</i>	0–22	–
	onion	ALLIU	<i>Allium</i>	0–22	–
	Forb, annual	2FA	<i>Forb, annual</i>	0–22	–
	Forb, dicot, perennial	2FDP	<i>Forb, dicot, perennial</i>	0–22	–
	Drummond's milkvetch	ASDR3	<i>Astragalus drummondii</i>	0–22	–
	milkvetch	ASTRA	<i>Astragalus</i>	0–22	–
Shrub/Vine					
4				159–286	
	Wyoming big sagebrush	ARTRW8	<i>Artemisia tridentata ssp. wyomingensis</i>	74–179	–
	winterfat	KRLA2	<i>Krascheninnikovia lanata</i>	11–135	–
	rubber rabbitbrush	ERNA10	<i>Ericameria nauseosa</i>	0–45	–
	yellow rabbitbrush	CHVI8	<i>Chrysothamnus viscidiflorus</i>	0–45	–
	prairie sagewort	ARFR4	<i>Artemisia frigida</i>	0–22	–
	broom snakeweed	GUSA2	<i>Gutierrezia sarothrae</i>	0–22	–
	plains pricklypear	OPPO	<i>Opuntia polyacantha</i>	0–11	–

Animal community

The Clayey Ecological Site provides a various habitat for an array of wildlife species. Prior to the settlement of this area, large herds of antelope, elk, and bison roamed. Though the bison have been replaced, mostly with domesticated livestock, elk and antelope still frequently utilize this largely intact landscape for winter habitat in areas adjacent to forests.

The relatively high grass component of the Reference Community provides excellent nesting cover for multiple neotropical migratory birds that select for open grasslands, such as the long-billed curlew and McCown's longspur.

Greater sage grouse may be present on sites with suitable habitat, typically requiring a minimum of 15 percent sagebrush canopy cover (Braun et al., 1977). The Bluebunch Community (1.1.1) is likely to have minimal sage grouse presence given its low sagebrush canopy cover. However, the potentially diverse forb component of the Reference State may provide important early-season (spring) foraging habitat for the greater sage grouse and their broods. Other communities on the site with sufficient sagebrush cover may harbor sage grouse populations, specifically community 2.1 (Mixed grass/shrubland) where big sagebrush populations are under a reduced fire regime. Also, as sagebrush canopy cover increases under Altered States 1.2.1 and 1.2.2 and, to a limited extent, under Degraded State 1.3.1, pygmy rabbit, Brewer's sparrow, and mule deer use may also increase.

Managed livestock grazing is suitable on this site due to the potential to produce an abundance of high-quality forage. This is often a preferred site for livestock grazing, and animals tend to congregate in these areas. In order to maintain the site productivity, grazing on adjoining sites with less production must be managed carefully to make sure utilization on this site is not excessive. Management objectives should include maintenance or improvement of the native plant community. Careful management of the timing and duration of grazing is important. Shorter grazing periods and adequate deferment during the growing season are recommended for plant maintenance, health, and recovery. Warm-season defoliation of bluebunch wheatgrass can result in high mortality and reduced vigor in plants (McLean and Wikeem, 1985). They also suggest, based on prior studies, that regrowth is necessary before dormancy to reduce injury of bluebunch.

Grazing season has more influence on winterfat than grazing intensity. Late winter or early spring grazing is detrimental. However, early winter grazing may be beneficial (Blaisdell and Holmgren, 1984).

Continual non-prescribed grazing of this site will be detrimental, will alter the plant composition and production over time, and will result in the transition to the Altered State. The transition to other states will depend on the duration of poorly managed grazing and other circumstances, such as weather conditions and fire frequency.

The Altered State is subject to further degradation to the Degraded State or the Invaded State. Management should focus on grazing management strategies that will prevent further degradation, such as rest rotation, seasonal grazing deferment, or winter grazing where feasible. Communities within this state are still stable under proper management. Forage quantity and quality may be substantially decreased from the Reference State.

In the Degraded State, grazing may be possible but is generally not economically or environmentally sustainable.

Grazing is possible in the Invaded State. Invasive species are generally less palatable than native grasses. Forage production is typically greatly reduced in this state. Due to the aggressive nature of invasive species, sites in the Invaded State face an increased risk of further degradation by invasive-dominant communities. Grazing must be carefully managed to avoid further soil loss and degradation and possible livestock health issues.

Prescriptive grazing can be used to manage invasive species. In some instances, carefully targeted grazing (sometimes in combination with other treatments) can reduce or maintain the species composition of invasive species.

Hydrological functions

The hydrologic cycle functions best in the Reference State with good infiltration and deep percolation of rainfall; however, the cycle degrades as the vegetation community declines. Rapid rainfall infiltration, high soil organic matter, good soil structure, and good porosity accompany high bunchgrass canopy cover (Thurow et al., 1986).

High ground cover reduces raindrop impact on the soil surface, which keeps erosion and sediment transport low. Water leaving the site will have a minimal sediment load, which allows for high water quality in associated streams. High rates of infiltration will allow water to move below the rooting zone during periods of heavy rainfall. The Bluebunch Community (1.1) should have no rills or gullies present, and drainage ways should be vegetated and stable. Water flow patterns, if present, will be barely observable. Plant pedestals are essentially nonexistent. Plant litter remains in place and is not moved by wind or water.

In the Shortgrass/Shrubland Community (1.2.2), the Degraded State (1.3) and the Invaded State (1.4) canopy and ground cover compared to the Reference State (1.1), which impedes the hydrologic cycle. Infiltration will decrease and runoff will increase due to reduced ground cover, the presence of shallow-rooted species, rainfall splash, soil capping, reduced organic matter, and poor structure. Sparse ground cover and decreased infiltration can increase the frequency and severity of flooding within a watershed. Soil erosion is accelerated, the quality of surface runoff is poor, and sedimentation increases. (McCalla et al., 1984)

Recreational uses

This site provides some limited recreational opportunities for hiking, horseback riding, big game hunting, and upland bird hunting. Some forbs have flowers that appeal to photographers. This site provides valuable open space.

Wood products

none

Other products

none

Inventory data references

The information contained within this ecological site description has been obtained from field observations, historic data, and professional judgement. Inventory sites are located across southwest Montana.

References

- Arno, S.F. and G.E. Gruell. 1982. Fire History at the Forest-Grassland Ecotone in Southwestern Montana. *Journal of Range Management* 36:332–336.
- Bestelmeyer, B. and J. Brown. 2005. State-and-Transition Models 101: A Fresh look at vegetation change.
- Blaisdell, J.P. 1958. Seasonal development and yield of native plants on the Upper Snake River Plains and their relation to certain climate factors.
- Blaisdell, J.P. and R.C. Holmgren. 1984. Managing Intermountain Rangelands--Salt-Desert Shrub Ranges. General Tech Report INT-163. USDA Forest Service, Intermountain Forest and Range Experiment Station, Ogden, UT. 52.
- Braun, C.E., T. Britt, and R.O. Wallestad. 1977. Guidelines for Maintenance of Sage Grouse Habitats. *Wildlife Society Bulletin (1973-2006)* 5:99–106.
- Cleland, D.T., J.A. Freeouf, J.E. Keys, G.J. Nowacki, C. Carpenter, and W.H. McNab. 2007. Ecological Subregions: Sections and Subsections of the Coterminous United States. USDA Forest Service, General Technical Report WO-76. Washington, DC. 1–92.

- Colberg, T.J. and J.T. Romo. 2003. Clubmoss effects on plant water status and standing crop. *Journal of Range Management* 56:489–495.
- DiTomaso, J.M. 2000. Invasive weeds in Rangelands: Species, Impacts, and Management. *Weed Science* 48:255–265.
- Dormaer, J.F., B.W. Adams, and W.D. Willms. 1997. Impacts of rotational grazing on mixed prairie soils and vegetation. *Journal of Range Management* 50:647–651.
- Hansen, K. and W. Wyckoff. 1991. Settlement, Livestock Grazing and Environmental Change in Southwest Montana, 1860–1990. *Environmental History Review* 15:45–71.
- Hobbs, J.R. and S.E. Humphries. 1995. An integrated approach to the ecology and management of plant invasions. *Conservation Biology* 9:761–770.
- Lacey, J.R., C.B. Marlow, and J.R. Lane. 1989. Influence of Spotted knapweed (*Centaurea maculosa*) on surface runoff and sediment yield. *Weed Technology* 3:627–630.
- Lacey, J.R. and H.W. Van Poolen. 1979. Grazing System Identification. *Journal of Range Management*, Jan edition 32:38–39.
- Lesica, P. and S.V. Cooper. 1997. Presettlement vegetation of Southern Beaverhead County, MT.
- Masters, R. and R. Sheley. 2001. Principles and practices for managing rangeland invasive plants. *Journal of Range Management* 38:21–26.
- McCalla, G.R., W.H. Blackburn, and L.B. Merrill. 1984. Effects of Livestock Grazing on Infiltration Rates of the Edwards Plateau of Texas. *Journal of Range Management* 37:265–269.
- McLean, A. and S. Wikeem. 1985. Influence of season and intensity of defoliation on bluebunch wheatgrass survival and vigor in southern British Columbia. *Journal of Range Management* 38:21–26.
- Mueggler, W.F. and W.L. Stewart. 1980. Grassland and Shrubland Habitat Types of Western Montana.
- Noy-Meir, I. 1973. Desert Ecosystems: Environment and Producers. *Annual Review of Ecology and Systematics* 4:25–51.
- Pellant, M. and L. Reichert. 1984. Management and Rehabilitation of a burned winterfat community in Southwestern Idaho. Proceedings--Symposium on the biology of Atriplex and related Chenopods. 1983 May 2-6; Provo UT General Technical Report INT-172.. USDA Forest Service Intermountain Forest and Range Experiment Station. 281–285.
- Personius, T.L., C.L. Wambolt, J.R. Stephens, and R.G. Kelsey. 1987. Crude Terpenoid Influence on Mule Deer Preference for Sagebrush. *Journal of Range Management* 40:84–88.
- Ross, R.L., E.P. Murray, and J.G. Haigh. July 1973. Soil and Vegetation of Near-pristine sites in Montana.

Smoliak, S., R.L. Ditterlin, J.D. Scheetz, L.K. Holzworth, J.R. Sims, L.E. Wiesner, D.E. Baldrige, and G.L. Tibke. 2006. Montana Interagency Plant Materials Handbook.

Stavi, I. 2012. The potential use of biochar in reclaiming degraded rangelands. *Journal of Environmental Planning and Management* 55:1–9.

Stringham, T.K. and W.C. Krueger. 2001. States, Transitions, and Thresholds: Further refinement fro rangeland applications.

Sturm, J.J. 1954. A study of a relict area in Northern Montana. University of Wyoming, Laramie 37.

Thurow, T.L., Blackburn W. H., and L.B. Merrill. 1986. Impacts of Livestock Grazing Systems on Watershed. Page in *Rangelands: A Resource Under Siege: Proceedings of the Second International Rangeland Congress*.

Wambolt, C. and G. Payne. 1986. An 18-Year Comparison of Control Methods for Wyoming Big Sagebrush in Southwestern Montana. *Journal of Range Management* 39:314–319.

Whitford, W.G., E.F. Aldon, D.W. Freckman, Y. Steinberger, and L.W. Parker. 1989. Effects of Organic Amendments on Soil Biota on a Degraded Rangeland. *Journal of Range Management* 41:56–60.

Wilson, A.M., G.A. Harris, and D.H. Gates. 1966. Cumulative Effects of Clipping on Yield of Bluebunch wheatgrass. *Journal of Range Management* 19:90–91.

Approval

Kirt Walstad, 5/01/2024

Rangeland health reference sheet

Interpreting Indicators of Rangeland Health is a qualitative assessment protocol used to determine ecosystem condition based on benchmark characteristics described in the Reference Sheet. A suite of 17 (or more) indicators are typically considered in an assessment. The ecological site(s) representative of an assessment location must be known prior to applying the protocol and must be verified based on soils and climate. Current plant community cannot be used to identify the ecological site.

Author(s)/participant(s)	Grant Petersen
Contact for lead author	grant.petersen@usda.gov
Date	08/29/2019
Approved by	Kirt Walstad
Approval date	
Composition (Indicators 10 and 12) based on	Annual Production

Indicators

1. **Number and extent of rills:** Rills are not present in the reference condition.
-

2. **Presence of water flow patterns:** Water flow patterns are not present in the reference condition.

3. **Number and height of erosional pedestals or terracettes:** Pedestals are not evident in the reference condition.

4. **Bare ground from Ecological Site Description or other studies (rock, litter, lichen, moss, plant canopy are not bare ground):** Bare ground is minimal (0 to 10 percent). It consists of small, randomly scattered patches.

5. **Number of gullies and erosion associated with gullies:** No gullies are present in the Reference State.

6. **Extent of wind scoured, blowouts and/or depositional areas:** No wind scoured, blowouts, or depositional areas are present in the Reference State.

7. **Amount of litter movement (describe size and distance expected to travel):** No litter movement is expected. Herbaceous litter falls within the rain shadow of the plant and does not move.

8. **Soil surface (top few mm) resistance to erosion (stability values are averages - most sites will show a range of values):** The soil surface is stable. Under canopy soil stability rating will be 5 to 6 and non-canopy sites will receive soil stability ratings of 3 to 6.

9. **Soil surface structure and SOM content (include type of structure and A-horizon color and thickness):** Soil Structure at the surface is typically weak to medium fine granular. A Horizon should be 4-6 inches thick with color, when wet, typically ranging in Value of 3 or less and Chroma of 3 or less. Local geology may affect color in which it is important to reference the Official Series Description (OSD) for characteristic range.

10. **Effect of community phase composition (relative proportion of different functional groups) and spatial distribution on infiltration and runoff:** Evenly distributed across the site, bunchgrasses improve infiltration while rhizomatous grass protects the surface from runoff forces. Infiltration of the Clayey ecological site is well drained but has a slow infiltration rate. An even distribution of mid stature grasses comprising about 60 percent of site production, cool season rhizomatous grasses 25 percent of site production along with a mix of shortgrass, forbs and shrubs (5 to 25 percent).

11. **Presence and thickness of compaction layer (usually none; describe soil profile features which may be mistaken for compaction on this site):** Not present, some soils profiles may contain an abrupt transition to an Argillic horizon which can be misinterpreted as compaction however the soil structure will typically be fine to medium subangular blocky whereas a compaction layer will tend to be platy or structureless (massive).

12. **Functional/Structural Groups (list in order of descending dominance by above-ground annual-production or live foliar cover using symbols: >>, >, = to indicate much greater than, greater than, and equal to):**

Dominant: Mid-statured, cool season, perennial bunchgrasses primarily bluebunch wheatgrass and green needlegrass

Sub-dominant: shrubs ≥ rhizomatous grass = short grass/grasslikes = forbs > subshrubs

Other:

Additional:

13. **Amount of plant mortality and decadence (include which functional groups are expected to show mortality or decadence):** Mortality in herbaceous species is not evident. Species with bunch growth forms may have some natural mortality in centers is 3 percent or less. Shrubs, subshrubs mortality does not exceed 5 percent for any given species.
-

14. **Average percent litter cover (%) and depth (in):** Total litter cover ranges from 40 to 60 percent. Most litter is irregularly distributed on the soil surface and is not readily at a measurable depth.
-

15. **Expected annual annual-production (this is TOTAL above-ground annual-production, not just forage annual-production):** Production is variable from 950lbs/acre to 1700lbs/acre. Representative value of approximately 1250lbs/acre.
-

16. **Potential invasive (including noxious) species (native and non-native). List species which BOTH characterize degraded states and have the potential to become a dominant or co-dominant species on the ecological site if their future establishment and growth is not actively controlled by management interventions. Species that become dominant for only one to several years (e.g., short-term response to drought or wildfire) are not invasive plants. Note that unlike other indicators, we are describing what is NOT expected in the reference state for the ecological site:** Non-native invasive species on this ecological site include (but not limited to): dandelion (*Taraxacum* spp.), cheatgrass (*Bromus tectorum*), field brome (*Bromus arvensis*), spotted knapweed (*Centaurea stoebe*), butter and eggs (*Linaria vulgaris*), leafy spurge (*Euphorbia esula*), and ventenata (*Ventenata dubia*)

Native species with the ability to indicate degradation however species presence alone does not imply degradation: Sandberg bluegrass (*Poa secunda*), big sagebrush (*Artemisia tridentata*), blue grama (*Bouteloua gracilis*), broom snakeweed (*Gutierrezia sarothrae*), rubber rabbitbrush (*Ericameria nauseosa*), yellow rabbitbrush (*Chrysothamnus viscidiflorus*), Rocky Mountain juniper (*Juniperus scopulorum*), ponderosa pine (*Pinus ponderosa*) when their populations are significant enough to affect ecological function, indicate site condition departure.

17. **Perennial plant reproductive capability:** Capability is very high. Density of plants indicates that plants reproduce at level sufficient to fill available resource. Plants are producing seed, reproductive tillers, or both in order to balance natural mortality with species recruitment.
-