

Ecological site EX044B01A030

Limy (Ly) LRU 01 Subset A

Last updated: 9/11/2023
Accessed: 05/20/2024

General information

Provisional. A provisional ecological site description has undergone quality control and quality assurance review. It contains a working state and transition model and enough information to identify the ecological site.

MLRA notes

Major Land Resource Area (MLRA): 044B—Central Rocky Mountain Valleys

Major Land Resource Area (MLRA) 44B, Central Rocky Mountain Valleys, is nearly 3.7 million acres of southwest Montana and borders two MLRAs: 43B Central Rocky Mountains and Foothills and 46 Northern and Central Rocky Mountain Foothills.

The major watersheds of this MLRA are those of the Missouri and Yellowstone Rivers and their associated headwaters such as the Beaverhead, Big Hole, Jefferson, Ruby, Madison, Gallatin, and Shields Rivers. These waters allow for extensive irrigation for crop production in an area that would generally only be compatible with rangeland and grazing. The Missouri River and its headwaters are behind several reservoirs that supply irrigation water, hydroelectric power, and municipal water. Limited portions of the MLRA are west of the Continental Divide along the Clark Fork River.

The primary land use of this MLRA is production agriculture (grazing, small grain production, and hay), but there is some limited mining. Urban development is high with large expanses of rangeland converted to subdivisions for a rapidly growing population.

The MLRA consists of one Land Resource Unit (LRU) and seven climate based LRU subsets. These subsets are based on a combination of Relative Effective Annual Precipitation (REAP) and frost free days. Each subset expresses a distinct set of plants that differentiate it from other LRU subsets. Annual precipitation ranges from a low of 9 inches to a high near 24 inches. The driest areas tend to be in the valley bottoms of southwest Montana in the rain shadow of the mountains. The wettest portions tend to be near the edge of the MLRA at the border with MLRA 43B. Frost free days also vary widely from less than 30 days in the Big Hole Valley to around 110 days in the warm valleys along the Yellowstone and Missouri Rivers.

The plant communities of the MRLA are highly variable, but the dominant community is a cool-season grass and shrub-steppe community. Warm-season grasses have an extremely limited extent in this MLRA. Most subspecies of big sagebrush are present, to some degree, across the MLRA.

LRU notes

MLRA 44B has one LRU that covers the entire MLRA. The LRU has been broken into seven climate subsets based on a combination of Relative Effective Annual Precipitation (REAP) and frost free days. Each combination of REAP and frost free days results in a common plant community that is shared across the subset. Each subset is giving a letter designation of A through F for sites that do not receive additional water and Y for sites that receive additional water.

LRU 01 Subset A has a REAP of nine to 14 inches (228.6-355.6mm) with a frost free days range of 70 to 110 days. This combination of REAP and frost free days results in a nearly treeless sagebrush steppe landscape.

The soil moisture regime is Ustic, dry that borders on Aridic and has a Frigid soil temperature regime.

Classification relationships

Mueggler and Stewart. 1980. Grassland and Shrubland habitat types of Western Montana

1. *Stipa comata/Bouteloua gracilis* h.t.
2. *Agropyron spicatum/Bouteloua gracilis* h.t.

Montana Natural Heritage Program Vegetation Classification

1. *Stipa comata - Bouteloua gracilis* Herbaceous Vegetation (STICOM – BOUGRA) Needle and thread/Blue grama
Natural Heritage Conservation Rank-G5 / S5
Edition / Author- 99-11-16 / S.V. Cooper,

EPA Ecoregions of Montana, Second Edition:

- Level I: Northwestern Forested Mountains
- Level II: Western Cordillera
- Level III: Middle Rockies & Northern Great Plains
- Level IV: Paradise Valley
Townsend Basin
Dry Intermontane Sagebrush Valleys
Shield-Smith Valleys

National Hierarchical Framework of Ecological Units:

- Domain: Dry
- Division: M330 – Temperate Steppe Division – Mountain Provinces
- Province: M332 – Middle Rocky Mountain Steppe – Coniferous Forest – Alpine Meadow
- Section: M332D – Belt Mountains Section
M332E – Beaverhead Mountains Section
- Subsection: M332Ej – Southwest Montana Intermontane Basins and Valleys
M332Dk – Central Montana Broad Valleys

Ecological site concept

The Limy ecological site is an upland site formed from alluvium or slope alluvium and is on slopes less than 60 percent. The site does not receive additional moisture from a water table or flooding. It is moderately deep to very deep and has no root-restrictive layers within 20 inches (50cm). The surface of the site has less than five percent stone and is not skeletal, with less than 35 percent rock fragments in the 10 to 20-inch depth. Soil surface texture ranges from sandy loam to clay loam in surface mineral 4 inches. The site does not have a saline or saline-sodic influence and is strongly or violently effervescent within four inches of the mineral surface. Calcium carbonates may increase with depth.

Associated sites

EX044B01A031	Limy Droughty (LyDr) LRU 01 Subset A Limy Droughty is often occupies similar landscape position and has a similar plant community.
EX044B01A032	Loamy (Lo) LRU 01 Subset A Loamy sites tend to occupy slightly concave sites where carbonates are able to leach below 4 inches.

Similar sites

EX044B01A031	Limy Droughty (LyDr) LRU 01 Subset A Limy Droughty ecological site expresses similar plant community and state and transition model. It differs by being skeletal between 10 and 20 inches and will have reduced production.
EX044B01A132	Shallow Limy (SwLy) LRU 01 Subset A Shallow Limy ecological site has similar basic plant community however has significantly lower production. This site differs in that the soil rooting depth is less than 20 inches.

Table 1. Dominant plant species

Tree	Not specified
Shrub	(1) <i>Chrysothamnus viscidiflorus</i> (2) <i>Artemisia tridentata ssp. wyomingensis</i>
Herbaceous	(1) <i>Pseudoroegneria spicata</i> (2) <i>Hesperostipa comata</i>

Legacy ID

R044BA030MT

Physiographic features

This ecological site occurs on slopes ranging from nearly level to 60 percent; however, the core concept slopes exist between 4 and 10 percent. It is an area of dissected mountain valleys. The parent material is alluvium and slope alluvium of mixed geologic origin.

Table 2. Representative physiographic features

Landforms	(1) Valley > Alluvial fan (2) Valley > Fan remnant (3) Valley > Eroded fan remnant
Flooding frequency	None
Ponding frequency	None
Elevation	1,158–2,085 m
Slope	4–10%
Aspect	Aspect is not a significant factor

Table 3. Representative physiographic features (actual ranges)

Flooding frequency	Not specified
Ponding frequency	Not specified
Elevation	Not specified
Slope	1–60%

Climatic features

The Central Rocky Mountain Valleys MLRA has a continental climate. Fifty to sixty percent of the annual long-term average precipitation falls between May and August. Average precipitation for LRU 01 Subset A is 12 inches (305mm), and the frost-free period averages 78 days. Precipitation is highest in May and June.

Table 4. Representative climatic features

Frost-free period (characteristic range)	70-110 days
Freeze-free period (characteristic range)	110-140 days
Precipitation total (characteristic range)	229-356 mm
Frost-free period (actual range)	70-110 days
Freeze-free period (actual range)	110-140 days
Precipitation total (actual range)	229-356 mm
Frost-free period (average)	78 days
Freeze-free period (average)	125 days

Precipitation total (average)	305 mm
-------------------------------	--------

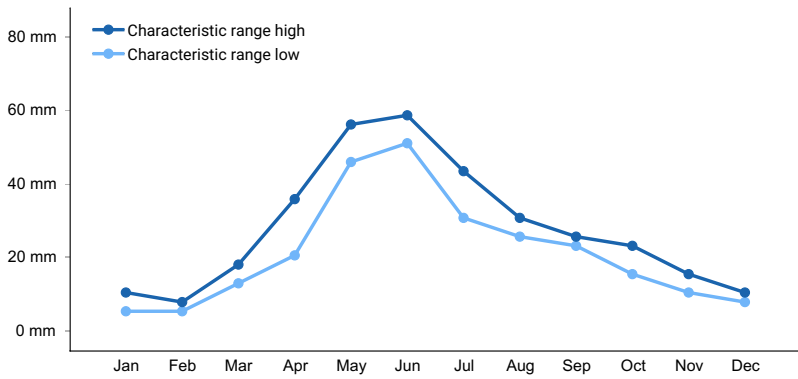

Figure 1. Monthly precipitation range

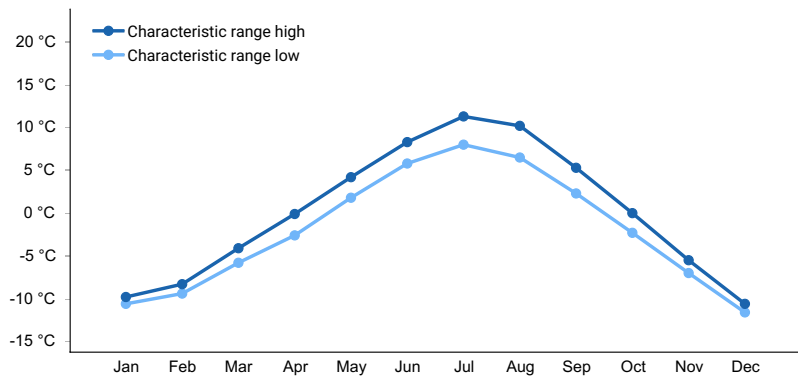

Figure 2. Monthly minimum temperature range

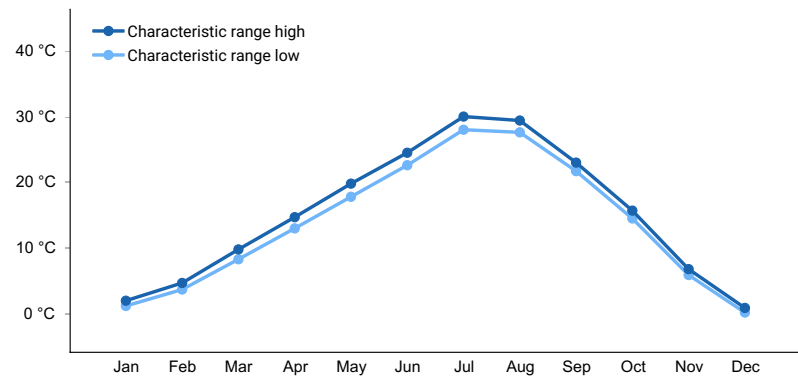

Figure 3. Monthly maximum temperature range

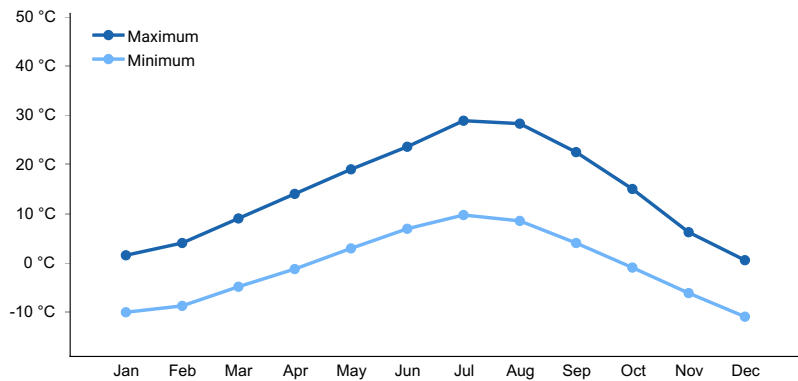

Figure 4. Monthly average minimum and maximum temperature

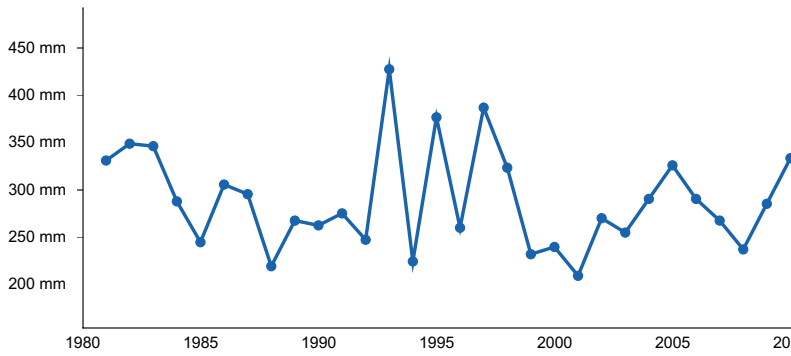

Figure 5. Annual precipitation pattern

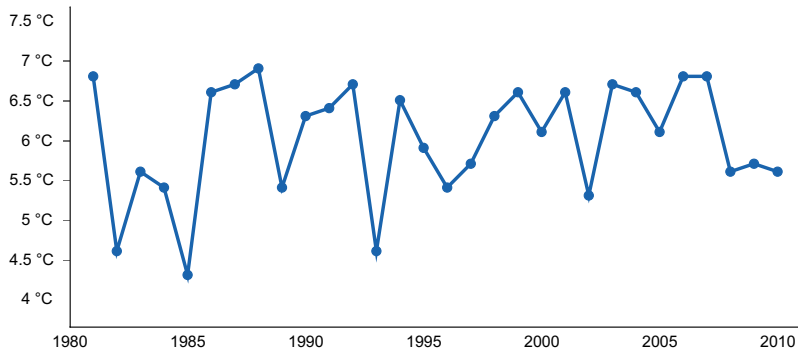

Figure 6. Annual average temperature pattern

Climate stations used

- (1) HELENA RGNL AP [USW00024144], Helena, MT
- (2) GARDINER [USC00243378], Gardiner, MT
- (3) DILLON AP [USW00024138], Dillon, MT
- (4) DEER LODGE 3 W [USC00242275], Deer Lodge, MT
- (5) TRIDENT [USC00248363], Three Forks, MT
- (6) BOULDER [USC00241008], Boulder, MT
- (7) DILLION U OF MONTANA WESTERN [USC00242409], Dillon, MT
- (8) ENNIS [USC00242793], Ennis, MT
- (9) TWIN BRIDGES [USC00248430], Sheridan, MT
- (10) TOWNSEND [USC00248324], Townsend, MT

Influencing water features

This ecological site is an upland site not associated with current water features

Wetland description

This site is not associated with wetlands.

Soil features

These soils are moderately deep to very deep, have moderately slow to moderately rapid permeability, and are well drained. These soils are formed from alluvium and slope alluvium. Typically, soil surface textures consist of loam, sandy loam, and loamy sand textures, but may also include clay loams. Soils may have a gravelly surface, but this varies depending on their proximity to a Limy site. Common soils series in this ecological site include Amesha and Kalsted. These soils may exist across multiple ecological sites due to natural variations in slope, texture, rock fragments, and pH. An onsite soil pit and the most current ecological site key are required to classify an ecological site.

Table 5. Representative soil features

Parent material	(1) Alluvium–igneous, metamorphic and sedimentary rock (2) Slope alluvium–igneous, metamorphic and sedimentary rock
Surface texture	(1) Gravelly loam (2) Sandy loam (3) Loamy sand
Family particle size	(1) Loamy
Drainage class	Moderately well drained to well drained
Permeability class	Moderately slow to moderately rapid
Soil depth	51 cm
Surface fragment cover <=3"	0–20%
Surface fragment cover >3"	0–10%
Available water capacity (0-101.6cm)	7.62–20.32 cm
Calcium carbonate equivalent (0-101.6cm)	20%
Electrical conductivity (0-101.6cm)	0–4 mmhos/cm
Sodium adsorption ratio (0-101.6cm)	0–13
Soil reaction (1:1 water) (0-101.6cm)	7.8–8.4
Subsurface fragment volume <=3" (0-50.8cm)	5–30%
Subsurface fragment volume >3" (0-50.8cm)	0–20%

Ecological dynamics

The Limy ecological site reference plant community is dominated by bluebunch wheatgrass (*Pseudoroegneria spicata*) and needle-and-thread (*Hesperostipa comata*). Subdominant species trend toward winterfat (*Krascheninnikovia lanata*) and Indian ricegrass (*Achnatherum hymenoides*). This potential is suggested by investigations showing a predominance of perennial grasses on near-pristine range sites (Ross et al., 1973). In the reference plant community, shrubs are a minor vegetative component.

The Limy ecological site occurs across a relatively large landscape; slight variations within the plant community occur due to elevation, frost-free days, and relative effective annual precipitation. Bluebunch wheatgrass, for example, occupies most known combinations of elevation and climate; however, under a drier moisture regime, it often shares dominance with needle and thread. These warmer, drier sites also tend to exhibit higher populations of warm-season shortgrasses such as blue grama and sand dropseed, especially when soil surface textures trend toward sandy loams. Conversely, colder, wetter sites within this Land Resource Unit often exhibit slight increases in Wyoming big sagebrush production, while bluebunch wheatgrass production also increases. Cold, dry rainshadow locations near the bases of the mountains express black sagebrush (*Artemisia nova*) as a dominant shrub.

Retrogression within this state can be caused by natural variations in precipitation, where needle and thread would be more common during dry climate cycles. Anecdotal evidence suggests that in drier portions of this LRU, the reference state may be dominated exclusively by needle and thread; however, the lack of bluebunch wheatgrass is likely due to long-term early season grazing or overuse.

A shift to the dominance of shrubs may occur in response to improper grazing management, drought, or where Wyoming big sagebrush occurs due to a lack of fire. Shrub encroachment by a variety of species, including broom snakeweed (*Gutierrezia sarothrae*), fringed sagewort (*Artemisia frigida*), Wyoming big sagebrush (*Artemisia tridentata* ssp. *wyomingensis*), rubber rabbitbrush (*Ericameria nauseosa*), green rabbitbrush (*Chrysothamnus*

viscidiflorus), black sagebrush (*Artemisia nova*), and plains prickly pear (*Opuntia polyacantha*) occur within this site as the mid-stature bunchgrasses decrease. Shrub dominance and grass loss are associated with soil erosion and, ultimately, thinning of the native soil surface. Subsequent loss of soil could lead to a Degraded Shortgrass State. All states could also lead to the Invaded State when there is a lack of weed prevention and control measures.

Historical records indicate that, prior to the introduction of livestock (cattle and sheep) during the late 1800s, elk and bison grazed this ecological site. Grazed areas received periodic high intensity, short duration grazing pressure due to bison's nomadic nature and herd structure. Livestock forage was noted as being minimal in areas recently grazed by bison (Lesica and Cooper 1997). Meriwether Lewis documented that he was met by 60 Shoshone warriors on horseback in August 1805, and the Corps of Discovery was later supplied with horses by the same band of Shoshone. This suggests that the areas near the modern-day Montana towns of Twin Bridges, Dillon, Grant, and Dell were grazed by an untold number of horses for nearly 50 years prior to the large introduction of cattle and sheep. The gold boom of the 1860s brought the first herds of livestock overland from Texas, and homesteaders began settling the area. During this time, cattle were the primary domestic grazers in the area. In the 1890s, sheep production increased by more than 400 percent and dominated the livestock industry until the 1930s. Since then, cattle production has dominated the region's livestock industry (Wyckoff and Hansen 2001).

Due to the slightly alkaline to moderately alkaline nature and rocky nature of the soils on this site, the potential for crop production is extremely limited.

Some of the major invasive species that can occur on this site include spotted knapweed (*Centaurea stoebe*), leafy spurge (*Euphorbia esula*), and cheatgrass (*Bromus tectorum*). Cheatgrass currently poses the greatest risk to this ecological site. In general, invasive weeds are not common in most ecological sites and tend to occupy limited areas in small patches near traditional watering facilities, along roads, and other areas that receive high soil disturbance.

Plant Communities and Transitional Pathways

The diagram below depicts a state and transition model for this Limy ecological site. Thorough descriptions of each state, transition, plant community, and pathway follow the model. This model is based on available experimental research, field data, field observations, and interpretations by experts. It is likely to change as knowledge increases.

The plant communities within the same ecological site will differ across the MLRA due to the naturally occurring variability in weather, soils, and aspect. The biological processes on this site are complex; therefore, representative values are presented in a land management context. The species lists are representative and are not botanical descriptions of all species occurring, or potentially occurring, on this site. They are intended to cover the core species and the known range of conditions and responses.

Both percent species composition by weight and percent canopy cover are referenced in this document. Canopy cover drives the transitions between communities and states because of the influence of shade, the interception of rainfall, and the competition for available water. Species composition by dry weight remains an important descriptor of the herbaceous community and of the community as a whole. Woody species are included in the species composition for the site. Calculating the similarity index requires species composition by dry weight.

This State and Transition Model (STM) includes only rangeland communities and states.

Although there is considerable qualitative experience supporting the pathways and transitions within the State and Transition Model (STM), no quantitative information exists that specifically identifies threshold parameters between grassland types and invaded types in this ecological site. For information on STMs, see the following citations: Bestelmeyer et al. (2003), Bestelmeyer et al. (2004), Bestelmeyer and Brown (2005), and Stringham et al. (2003).

State and transition model

Ecosystem states

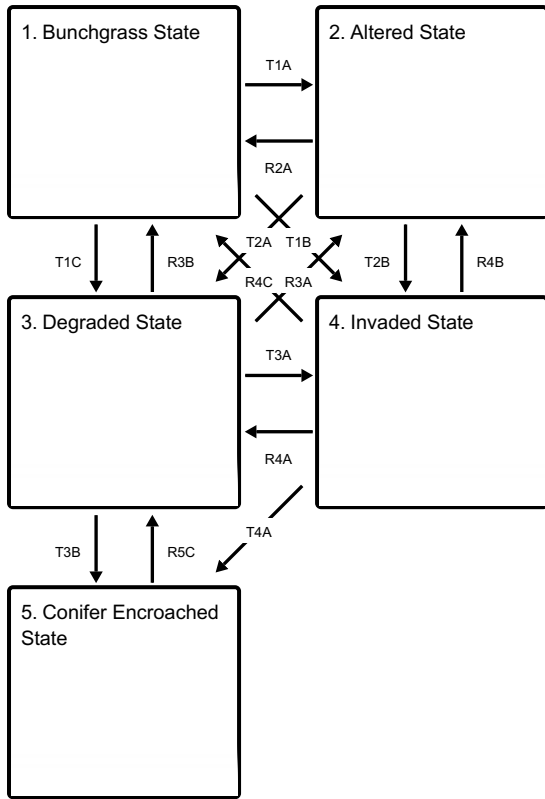

States 1, 5 and 2 (additional transitions)

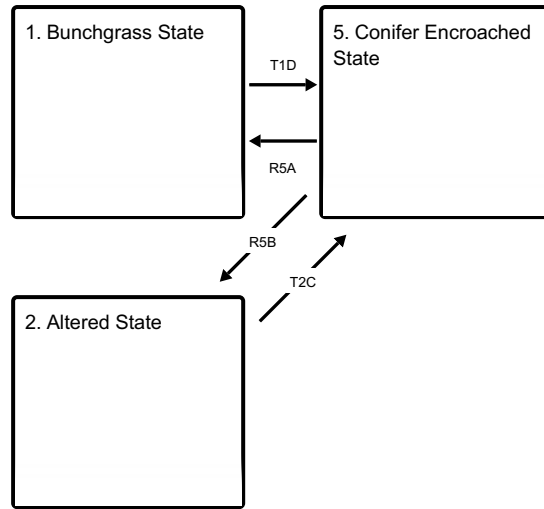

State 1 submodel, plant communities

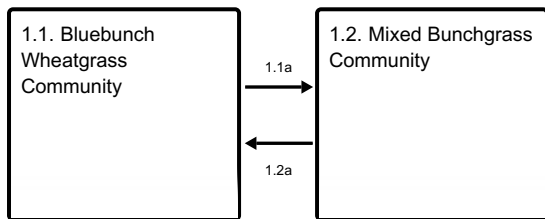

State 2 submodel, plant communities

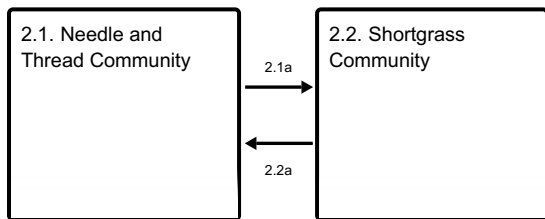

State 3 submodel, plant communities

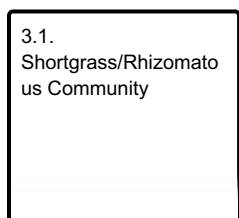

State 4 submodel, plant communities

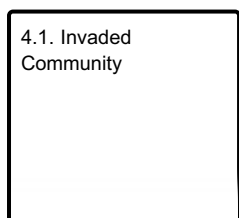

State 5 submodel, plant communities

5.1. Conifer
Encroached
Community

State 1 Bunchgrass State

The Bunchgrass State of this ecological site consists of two known potential plant communities 1.1 Bluebunch Community and 1.2 Mixed Bluebunch Community. These are described below but are generally characterized by a mid-stature, cool-season grass community with limited shrub production. Community 1.1 is dominated by bluebunch wheatgrass and is considered the reference, while Community 1.2 has a co-dominance of bluebunch and needle and thread with an increase in green rabbitbrush and Wyoming big sagebrush. These communities may meld into each other due to the varying conditions that occur in Southwest Montana, particularly during dry cycles where the needle and thread growth cycle takes better advantage of the limited moisture.

Community 1.1 Bluebunch Wheatgrass Community



Bluebunch wheatgrass (*Pseudoroegneria spicata*) and needle and thread (*Hesperostipa comata*) are typically dominant. Indian ricegrass (*Achnatherum hymenoides*) and winterfat (*Krascheninnikovia lanata*) are subordinates. Green needlegrass (*Nassella viridula*) tends to occupy sites with loamy to clay loam textures. Shrub species (Wyoming big sagebrush, black sagebrush, fringed sagewort, and broom snakeweed) remain a minor part of the community. Sandberg bluegrass (*Poa secunda*) and dryland sedges are also common. This state occurs on this Limy site in areas with proper livestock grazing or in areas with little or no grazing pressure. Bluebunch wheatgrass lacks resistance to grazing during the critical growing season (spring) and will decline in vigor and production if grazed in the critical growing season for more than one in three years (Wilson et al., 1960). The Bunchgrass State is moderately resilient and will return to dynamic equilibrium following a relatively short period of stress (such as drought or short-term improper grazing), provided a return of favorable or normal growing conditions and properly managed grazing. Shrubs make up a small portion of Reference Plant Community 1.1, including winterfat, black sagebrush, and Gardner's saltbush. As you move toward the wetter, cooler end of the LRU, Wyoming big sagebrush will become more common. Infrequent fires probably maintained Wyoming big sagebrush communities as open, seral stands of Wyoming big sagebrush with productive herbaceous understories. Wyoming big sagebrush steppe communities historically had low fuel loadings and were characterized by 10- to 70-year fire intervals that produced a mosaic of burned and unburned lands (Bunting et al., 1987). Following a fire on fine-textured soil, the perennial bunchgrasses recovered in a few years and were present to fuel a subsequent fire. Conversely, extensive wildfires burning under hot, dry conditions would have resulted in the nearly complete destruction of scattered sagebrush (Arno and Gruell 1983). Gardner's saltbush is described as fire resistant because it contains high concentrations of minerals that increase char formation but low concentrations of volatile, flammable compounds (West 1994). Winterfat is tolerant of low intensity fire but will kill with a hot fire (Pellant 1984). Blue grama and sand

dropseed, both warm-season species, are most commonly found in Limy sites with fine sandy loam surfaces.

Table 6. Annual production by plant type

Plant Type	Low (Kg/Hectare)	Representative Value (Kg/Hectare)	High (Kg/Hectare)
Grass/Grasslike	558	897	1140
Shrub/Vine	67	112	137
Forb	47	78	96
Total	672	1087	1373

Table 7. Ground cover

Tree foliar cover	0%
Shrub/vine/liana foliar cover	0-8%
Grass/grasslike foliar cover	30-60%
Forb foliar cover	3-7%
Non-vascular plants	0-1%
Biological crusts	0-1%
Litter	25-30%
Surface fragments >0.25" and <=3"	0-20%
Surface fragments >3"	0-10%
Bedrock	0%
Water	0%
Bare ground	3-10%

Table 8. Soil surface cover

Tree basal cover	0%
Shrub/vine/liana basal cover	0-3%
Grass/grasslike basal cover	5-15%
Forb basal cover	0-3%
Non-vascular plants	0%
Biological crusts	0-1%
Litter	25-30%
Surface fragments >0.25" and <=3"	0-20%
Surface fragments >3"	0-10%
Bedrock	0%
Water	0%
Bare ground	10-15%

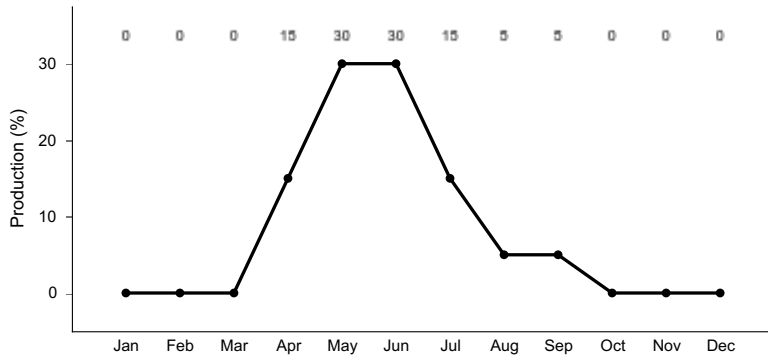

Figure 8. Plant community growth curve (percent production by month). MT44B032, Dry Uplands. Cool season grass dominated system. Most dry, upland sites located within MLRA 44B LRU A are characterized by early season growth which is mostly complete by Mid-July. Limited fall "green-up" if conditions allow..

Community 1.2 Mixed Bunchgrass Community



With proper grazing management over time, this site can come close to the diversity and complexity of the Bluebunch Wheatgrass Community (1.1). Without active management, the site is not likely to return to the reference community. Needle and thread tolerates grazing pressure better than bluebunch wheatgrass. The growing point for bluebunch wheatgrass is several inches above the ground, making it very susceptible to continued close grazing (Smoliack et al., 2006), while needle and thread growing points tend to be near the plant base. When more palatable and less grazing-tolerant plants decline due to poor grazing management, the species composition of needle and thread increases. Needle and thread and bluebunch wheatgrass share dominance in the Mixed Bunchgrass Community (1.2). Other grass species, which are more tolerant to grazing and are likely to increase compared to the Reference Plant Community, include Sandberg bluegrass (*Poa secunda*), prairie Junegrass, western/thickspike wheatgrass (*Pascopyrum smithii*, *Elymus lanceolatus*), and blue grama (*Bouteloua gracilis*). Some increaser forb species include western yarrow, Hood's phlox (*Phlox hoodii*), scarlet globemallow (*Sphaeralcea coccinea*), hairy goldenaster (*Heterotheca villosa*), and pussytoes (*Antennaria* spp.). Fringed sagewort (*Artemisia frigida*) is a shrub that also increases under prolonged drought or heavy grazing and can respond to precipitation that falls in July and August. Heavy, continuous grazing will reduce plant cover, litter, and mulch. The timing of grazing is important on this site because of the moisture limitations beyond June, especially on the drier sites. Bare ground will increase, exposing the soil to erosion. Litter and mulch will be reduced as plant cover declines. As long as the production of bluebunch wheatgrass is greater than 15 percent of total biomass production, the site can be returned to the Bluebunch Wheatgrass Community (Pathway 1.2A) under proper grazing management and favorable growing conditions. Needle and thread will continue to expand until they make up 60% or more of the species composition. Once bluebunch wheatgrass has been reduced to less than 15 percent dry weight, it may be difficult for the site to recover to the Reference Plant Community (1.1). The risk of soil erosion increases when canopy cover decreases below 50 percent. As soil conditions degrade, there will be a loss of organic matter, reduced litter, and reduced soil fertility. Degraded soil conditions increase the difficulty of reestablishing bluebunch wheatgrass and returning to the Reference Community (1.1). The Mixed Bunchgrass

Community (1.2) is the At-Risk Plant Community for this ecological site. When overgrazing continues, increaser species such as needle and thread and native forb species take over, resulting in the altered state (2) or degraded shortgrass state (3). Until the Mixed Bunchgrass Community (1.2) crosses the threshold into the Needle and Thread Community (2.1) or the Invaded Community (4.1), this community can be managed toward the Bluebunch Wheatgrass Community (1.1) using prescribed grazing and strategic weed control. It may take several years to achieve this recovery, depending on growing conditions, the vigor of remnant bluebunch wheatgrass plants, and the aggressiveness of the weed treatments.

Table 9. Annual production by plant type

Plant Type	Low (Kg/Hectare)	Representative Value (Kg/Hectare)	High (Kg/Hectare)
Grass/Grasslike	448	762	785
Shrub/Vine	90	142	168
Forb	30	48	56
Total	568	952	1009

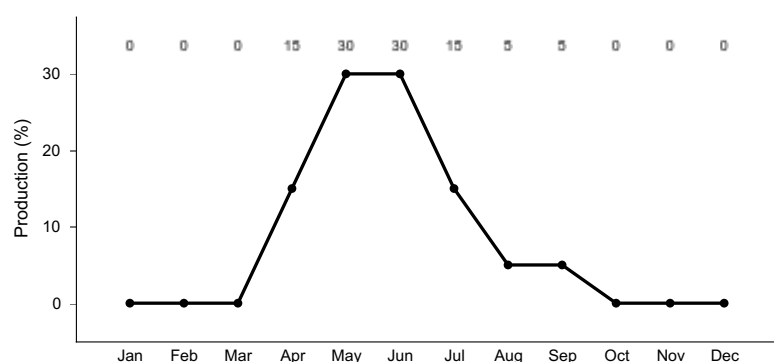

Figure 10. Plant community growth curve (percent production by month). MT44B032, Dry Uplands. Cool season grass dominated system. Most dry, upland sites located within MLRA 44B LRU A are characterized by early season growth which is mostly complete by Mid-July. Limited fall "green-up" if conditions allow..

Pathway 1.1a Community 1.1 to 1.2



Bluebunch Wheatgrass Community



Mixed Bunchgrass Community

Bluebunch wheatgrass loses vigor with improper grazing or extended drought. When vigor declines enough for plants to die or become smaller, species with higher grazing tolerance (in this ecological site, that would be needle and thread) increase in vigor and production as they access the resources previously used by bluebunch wheatgrass. The decrease in species composition by weight of bluebunch wheatgrass to less than 50 percent indicates that the plant community has shifted to the Mixed Bunchgrass Community (1.2). The driver for community shift 1.1A is improper grazing management or prolonged drought. This shift is triggered by the loss of vigor of bluebunch wheatgrass, soil erosion, or prolonged drought coupled with improper grazing. Blaisdell (1958) stated that drought and warmer-than-normal temperatures are known to advance plant phenology by as much as one month. During drought years, plants may be especially sensitive or reach a critical stage of development earlier than expected. Since needle-and-thread normally heads out in June and bluebunch wheatgrass in July, this should be taken into consideration when planning grazing management.

Pathway 1.2a Community 1.2 to 1.1



Mixed Bunchgrass Community



Bluebunch Wheatgrass Community

The Mixed Bunchgrass Community (1.2) will return to the Bluebunch Wheatgrass Community (1.1) with proper grazing management and appropriate grazing intensity. Favorable moisture conditions will facilitate or accelerate this transition. It may take several years of favorable conditions for the community to transition back to a bluebunch dominated state. The driver for this community shift (1.2A) is the increased vigor of bluebunch wheatgrass, to the point that it represents more than 50 percent of species composition. The trigger for this shift is the change in grazing management favoring bluebunch wheatgrass. These triggers are generally conservative grazing management styles such as deferred or rest rotations utilizing moderate grazing (less than 50 percent use) combined with favorable growing conditions such as cool, wet springs. These systems tend to promote increases in soil organic matter, which promotes microfauna and can increase infiltration rates. Inversely, long periods of rest at a time when this state is considered stable may not result in an increase in bluebunch wheatgrass, and it has been suggested (Noy-Meir 1975) that these long periods of rest or underutilization may actually drive the system to a lower level of stability by creating large amounts of standing biomass, dead plant caudex centers, and gaps in the plant canopy.

State 2 Altered State

This state is characterized by having less than 15 percent bluebunch wheatgrass by dry weight. It is represented by two communities that differ in the percent composition of needle and thread, production, and soil degradation. Production in this state can be similar to the Bunchgrass State (1). Some native plants tend to increase under prolonged drought and heavy grazing practices. A few of these species may include needle and thread, Sandberg bluegrass, scarlet globemallow, hairy goldenaster, and fringed sagewort. Microtopography, that was generally too small to delineate during soil mapping, will often exhibit increased canopy cover of Wyoming big sagebrush due to the slight addition of moisture increased. The Lewis and Clark journals (Moulton 1988) talk about the areas around the Hogback north of Dillon and Horse Prairie west of Clark Canyon Reservoir: "The soil of the plains is a light yellow clay very meager and intermixed with a large proportion of gravel, producing nothing except the twisted or bearded grass, sedge and prickly pears". Many of their travels were hampered because of the awns of needle and thread in their moccasins. This may suggest that there was extensive, repeated use prior to the Corps of Discovery expedition. Today, needle and thread dominates that area suggesting that transitioning from the Altered State back to the Bunchgrass State may require multiple years of recovery, reaffirming the Domaar 1997 study area.

Community 2.1 Needle and Thread Community



Long-term grazing mismanagement with continuous growing-season pressure will reduce the total productivity of the site and lead to an increase in bare ground. Once plant cover is reduced, the site is more susceptible to erosion and degradation of soil properties. Soil erosion or reduced soil fertility will result in reduced plant production.

Because it creates a threshold requiring energy input to return to the Bunchgrass State (1), soil erosion or loss of soil fertility indicates the transition to the Altered State (2). Transition to the Needle and Thread Community (2.1) may be exacerbated by extended drought conditions. Needle and thread dominates this Bunchgrass Community (2.1). Bluebunch wheatgrass makes up less than 15 percent of the species composition by dry weight, and the remaining bluebunch wheatgrass plants tend to be scattered and low in vigor. Increaser species will become more common, increasing competition for bluebunch wheatgrass. This makes it difficult for bluebunch wheatgrass to quickly respond to a change in grazing management alone. As a result, for the community to return to Bunchgrass State, an energy input is required (1). Wind and water erosion may be eroding soil from the plant interspaces. Soil fertility is reduced, and soil surface erosion resistance has declined compared to the Bunchgrass State (1). This community crossed a threshold compared to the Mixed Bunchgrass Community (1.2) due to the erosion of soil, vegetation composition, loss of soil fertility, or degradation of soil conditions. This results in a critical shift in the ecology of the site. The effects of soil erosion can alter the hydrology, soil chemistry, soil microorganisms, and soil structure to the point where intensive restoration is required to restore the site to another state or community. Changing grazing management alone cannot create sufficient improvement to restore the site within a reasonable time frame. Dormaar (1997) stated that with decreased grazing pressure, a needle and thread/blue grama plant community did not change species composition, but the content of the soil carbon increased. It will require a considerable input of energy to move the site back to Bunchgrass State (1). This state has lost soil or vegetation attributes to the point that recovery to the Bunchgrass State (1) will require reclamation efforts, i.e., soil rebuilding, intensive mechanical treatments, and/or reseeding. The transition to this state could result from overgrazing, especially repeated early-season grazing coupled with extensive drought. If heavy grazing continues, plant cover, litter, and mulch will continue to decrease, and bare ground will increase, exposing the soil to accelerated erosion. Litter and mulch will move off-site as plant cover declines. The Needle and Thread Community will then shift to a Shortgrass/Shrub Community (2.2). Continued improper grazing will drive the community to a Degraded Shortgrass State (3). Introduction or expansion of invasive species will further drive the plant community into the Invaded State (4).

Community 2.2

Shortgrass Community

With continued mismanagement of grazing, especially coupled with prolonged drought, needle and thread will decrease in vigor. The bunchgrasses will decline in production as plants die or become smaller, and species with higher grazing tolerance (such as western wheatgrass) will increase in vigor and production as they respond to resources previously used by the bunchgrasses. These less desirable, shallow-rooted species will become co-dominant with the taller bunchgrasses. Shrubs will become more competitive for limited moisture as bare ground and soil erosion increase.

Pathway 2.1a

Community 2.1 to 2.2

The driver for community shift 2.1A is continued improper grazing management. This shift is triggered by the continued loss of bunchgrass vigor, especially needle and thread. The mid- and short-statured grasses will become more competitive and will become co-dominant with the bunch grasses. Shrubs will increase their canopy cover but stay at about 15 percent.

Pathway 2.2a

Community 2.2 to 2.1

If proper grazing management is implemented, needle and thread may regain its vigor and move towards the Needle and Thread Community (2.1). This will give grasses an advantage over invading shrubs before too much competition takes place. The advantage to grasses comes from following a conservative grazing plan where utilization is reduced and rest or deferment is incorporated since the transition from Plant Community 2.1 to Plant Community 2.2 is likely caused by repeated heavy utilization. Van Poolen and Lacey (1979) found that forage production increased by an average of 35 percent on western ranges when converting heavy to moderate utilization (less than 50 percent). Shrub removal and favorable growing conditions can accelerate this process. If the site contains Wyoming big sagebrush (*Artemisia tridentata* spp. *wyomingensis*), low-intensity fire or mechanical treatment (Wambolt 1986) could reduce shrub competition and allow for increased vigor and the reestablishment of grass species.

State 3

Degraded State

A single plant community based on shortgrasses and rhizomatous grasses with mixed shrubs. Bare ground is common.

Community 3.1

Shortgrass/Rhizomatous Community

Soil loss continues or increases to the point that native perennial grasses make up less than 350 pounds of annual dry weight production. Grass and forb cover may be very sparse or clumped. Increaser species, shortgrasses, and shrubs dominate the plant community. Mid-stature perennial bunchgrass species (e.g., needle and thread) may exist, but only in small patches. This could occur due to overgrazing (failure to adjust stocking rates to declining forage production due to increased invasive dominance), a long-term lack of fire (if Wyoming big sagebrush occurs), or the introduction of invasive species. Production values may be as low as 200 pounds per acre with up to 70–9 percent basal bare ground (the foliar canopy is disregarded as a measurement), and plant basal area shrinks. In the most severe stages of degradation, there is a significant amount of bare ground, and large gaps occur between plants. Potential exists for soils to erode to the point that irreversible damage may occur. This is a critical shift in the ecology of the site. Soil erosion combined with a lack of organic matter deposition due to sparse vegetation creates changes to the hydrology, soil chemistry, soil microorganisms, and soil structure to the point where intensive restoration is required to restore the site to another state or community. Changing management (i.e., improving grazing management) cannot create sufficient change to restore the site within a reasonable time frame. This state is characterized by soil surface degradation and little plant soil surface cover. The forb component changes to being dominated by spiny phlox (*Phlox hoodii*), with shrub canopy cover becoming decumbent. Big sagebrush is replaced with a dominant community of broom snakeweed, rubber rabbitbrush, fringed sagewort, and plains prickly pear cactus. This state has lost soil or vegetation attributes to the point that recovery to the Bunchgrass Grassland State will require reclamation efforts, e.g., soil rebuilding, intensive mechanical treatments, and/or reseeding. This plant community may be in a terminal state and will not return to the reference state because of degraded soil conditions and the loss of higher successional native plant species. Key factors in the approach to transition include: a decrease in grass canopy cover and production; an increase in shrub canopy cover; increases in mean bare patch size; increases in soil crusting; decreases in the cover of cryptobiotic crusts; decreases in soil aggregate stability; and/or evidence of erosion, including water flow patterns and litter movement.

State 4

Invaded State

The Invaded State is identified as being in the exponential growth phase of invader abundance where control is a priority. Dominance (or relative dominance) of noxious or invasive species reduces species diversity, forage production, wildlife habitat, and site protection. A level of 20 percent invasive species composition by dry weight indicates that a substantial energy input will be required to create a shift to the grassland state (herbicide, mechanical treatment), even with a return to proper grazing management or favorable growing conditions. Prescriptive grazing can be used to manage invasive species. In some instances, carefully targeted grazing (sometimes in combination with other treatments) can reduce or maintain the species composition of invasive species. These communities within this state will follow a path if the invasive or noxious species continue to thrive without mechanical, biological, or chemical control methods to exceed 20 percent of species composition by dry weight. The invasive nature of the weed outcompetes the present plant community. Once the weed reaches its maximum population level for this site, effective control is unlikely without massive resource inputs. After invading species have established and spread, ecological processes at the site may change (Walker and Smith 1997).

Community 4.1

Invaded Community

Communities in this state may be structurally indistinguishable from the bunchgrass state except that invasive or noxious species exceed 20 percent of species composition by dry weight. Although there is no research to document the level of 20 percent, this is estimated to be the point in the invasion process following the lag phase based on the interpretation of Masters and Sheley (2001). For aggressive invasive species (i.e., spotted knapweed), a 20 percent threshold could be less than 10 percent. Early in the invasion process, there is a lag phase where the

invasive plant populations remain small and localized for long periods before expanding exponentially (Hobbs and Humphries 1995). Production in the invaded community may vary greatly. A site dominated by spotted knapweed, where soil fertility and chemistry remain near potential, may have production near that of the reference community. A site with degraded soils and an infestation of cheatgrass may produce only 10 to 20 percent of the reference community. The Invaded State (4) is reached when invasive species dominate the site, either in terms of species composition by weight or in terms of their impact on the community. As invasive species such as spotted knapweed, cheatgrass, and leafy spurge become established, they become very difficult to eradicate. Therefore, considerable effort should be put into preventing plant communities from crossing a threshold into the Invaded State (4) through early detection and proper management. Preventing new invasions is by far the most cost-effective control strategy, and typically places an emphasis on education. Control measures used on the noxious plant species impacting this ecological site include chemical, biological, and cultural control methods. The best success has been found with an integrated pest management (IPM) strategy that incorporates one or several of these options along with education and prevention efforts (DiTomaso 2000).

State 5 Conifer Encroached State

The Conifer Encroached State is still being researched however it may contain as many as 4 different communities. Due to limited available data for SW Montana, this state will remain provisional until more information is collected on the exact impacts on rangeland health.

Community 5.1 Conifer Encroached Community

Rocky Mountain juniper (*Juniperus scopulorum*), ponderosa pine (*Pinus ponderosa*), and Douglas fir (*Pseudotsuga menziesii*) encroachment is common on this ecological site and is generally focused in areas where the mountains of MLRA 44B transition quickly to MLRA 43B. Under the Reference State, no conifers should exist on this site. It is also noted that all states may transition to the Conifer Encroached State; however, encroachment is most likely to occur in the Altered State, where there is an increase in bare ground due to a combination of factors that allows seed-to-soil contact with reduced competition. Fire suppression and improper grazing management are the two most common triggers. The exact mode in which conifers begin to encroach varies; however, the trend points to a combination of 1 or more of the following: repeated moderately heavy to heavy grazing; reduced (non-existent) fire frequency; increased atmospheric carbon; and a generally warmer climate compared to that of pre-settlement. When heavy grazing occurs, areas in the plant canopy open, allowing for seed dispersal by bird or overland flow via rills on neighboring sites. The effects of conifer encroachment are not immediately noticeable, but over time, as the conifer canopy increases, light and water interception increase, which reduces opportunities for herbaceous plants. One paper (Barrett, 2007) suggests that for precipitation to penetrate the juniper canopy, events must be greater than 0.30 inches. Increased tree canopy creates perching sites for predators, which reduces site suitability for greater sage grouse. More information is needed on the full extent and impact of juniper encroachment on these plant communities for an approved ecological site description. Studies (Miller et al., 2000) based in an area similar to the Rocky Mountain Juniper community of Montana suggest following a phased approach to characterize the juniper stand. Not unlike the Western Juniper Community discussed in Miller et al., the Conifer Encroached Communities of Montana exhibit 3 or 4 different phases based, at this time, on qualitative assumptions. Phase I (Early) is defined by actively expanding juniper cover with generally less than 10 percent canopy cover and the trees' limbs generally touching the ground. This early stage generally has not completely lost its hydrologic functions, but herbaceous plant communities may show signs of reduced production and species richness. Control methods include mechanical removal and prescribed fire. Prescribed fire is still effective in this phase as it still contains the necessary native plants for recovery. The tree canopy is also low enough that the risk of a dangerously hot fire is reduced. Phase II (Midphase) is still actively expanding, but canopy cover may reach 15–25 percent, and due to the more mature trees, seed production is very high. This Midphase begins to highly restrict herbaceous and shrubby plants, and junipers tend to be codominant. Hydrology is departing from reference, with rills becoming longer and, in isolated areas, erosional gullies possible. Control methods for the Midphase should focus on mechanical treatment, as there is a high risk of catastrophic and potentially sterilizing fire. Phase III (Late Phase) is where conifer cover exceeds 25 percent and has slowed as a forest condition. Lower tree limbs begin to die, and the shrub cover is nearly gone. Traveling through this community is increasingly difficult. Conifers become the dominant plant, with herbaceous plant production greatly decreasing. Bare ground increases, and hydrologic function is nearly lost compared to a grass or shrub community. Late Phase should focus more on restoration than control, as the necessary plants will likely not be present to cross the threshold back to a rangeland situation.

Because soil stability and hydrologic function are lacking in this phase, mechanical juniper removal will be required. Phase IV (Closed Phase) is the steady state forest, where the system is nearly devoid of rangeland plants. The trees stop producing seed and begin to close in on each other. This phase is impassable, and nearly all light and precipitation are intercepted. Bare ground is high, and soil chemistry slowly changes due to acidification from conifer needles. The closed phase is extremely rare in this LRU for two reasons: 1) This phase takes upwards of 100 years to occur. 2) Management often occurs before trees are allowed to reach this phase. The presence of sagebrush stumps indicates that the historical plant community was rangeland, preventing misclassification of historic Juniper Forests (often more than 100 years old).

Transition T1A **State 1 to 2**

The Bunchgrass State (1) transitions to the Altered State (2) if bluebunch wheatgrass, by dry weight, decreases to below 15 percent or if bare ground cover is increased beyond 15 percent. The driver for this transition is the loss of taller bunchgrasses, which creates open areas in the plant canopy with bare soil. Soil erosion reduces soil fertility, which drives transitions to the Altered State. There are several other key factors signaling the approach of transition T1A: increases in soil physical crusting, decreases in cover of cryptogamic crusts, decreases in soil surface aggregate stability, and/or evidence of erosion including water flow patterns, development of plant pedestals, and litter movement. The trigger for this transition is improper grazing management and/or long-term drought, leading to a decrease in bluebunch wheatgrass composition to less than 15 percent and a reduction in total plant canopy cover.

Transition T1C **State 1 to 3**

The Bunchgrass State (1) transitions to the Degraded State (3) when bluebunch wheatgrass is removed from the plant community and needle and thread is subdominant among short-statured bunchgrasses such as Sandberg bluegrass. The trigger for this transition is the loss of taller bunchgrasses, which creates open spaces with bare soil. Soil erosion reduces soil fertility, causing a transition to a Degraded State. There are several other key factors signaling the approach of transition T1C: increases in soil physical crusting, decreases in cover of cryptogamic crusts, decreases in soil surface aggregate stability, and/or evidence of erosion including water flow patterns, development of plant pedestals, and litter movement. The driver for this transition is improper grazing management, intense or repeated fires, and/or heavy human disturbance. Rapid transition is generally realized where livestock are confined to small pastures for long periods of time.

Transition T1B **State 1 to 4**

Healthy plant communities are most resistant to invasion. However, regardless of grazing management, without some form of active weed management (chemical, mechanical, or biological control) and prevention, the Bunchgrass State (1) can transition to the Invaded State (4) in the presence of aggressive invasive species such as spotted knapweed, leafy spurge, and cheatgrass. This will occur even if the reference community is thriving. The Central Rocky Mountain Valleys tend to resist invasion by cheatgrass; however, repeated heavy grazing or intense human activities can open the interspaces of the bunchgrass community and allow for encroachment. Long-term stress conditions for native species (e.g., overgrazing, drought, and fire) accelerate this transition. If populations of invasive species reach critical levels, the site transitions to the Invaded State. The trigger for this transition is the presence of aggressive invasive species. The species composition by dry weight of invasive species approaches 10 percent.

Transition T1D **State 1 to 5**

5 percent canopy cover of conifer cover. The trigger is the presence of seeds and/or other viable material of invasive species.

Restoration pathway R2A **State 2 to 1**

The Altered State (2) has lost soil or vegetation attributes to the point that recovery to the Bunchgrass State (1) will require reclamation efforts such as soil rebuilding, intensive mechanical and cultural treatments, and/or revegetation. Low-intensity prescribed fires were used to reduce competitive increasers like needle and thread and Sandberg bluegrass. In areas prone to annual grass infestation, fire should be carefully planned or avoided. The drivers for this restoration pathway are reclamation efforts along with proper grazing management. The trigger is restoration efforts.

Transition T2A State 2 to 3

As improper grazing management continues, the vigor of bunch grasses will decrease and the shorter grasses and shrubs will increase, leading to the Degraded Shortgrass State (3). Prolonged drought will provide a competitive advantage to shrubs, allowing them to become co-dominant with grasses. Shrub canopy cover will increase above 15 percent. Key transition factors include: an increase in native shrub canopy cover; a reduction in bunchgrass production; a decrease in total plant canopy cover and production; increases in mean bare patch size; increases in soil crusting; decreases in the cover of cryptobiotic crusts; decreases in soil aggregate stability; and/or evidence of erosion, including water flow patterns and litter movement.

Transition T2B State 2 to 4

Invasive species can occupy the Altered State (2) and drive it to the Invaded State (4). The Altered State is at risk if invasive seeds and/or other viable material are present. The driver for this transition is more than 20 percent of the dry weight of invasive species. The trigger is the presence of seeds and/or other viable material from invasive species.

Transition T2C State 2 to 5

5 percent canopy cover of conifer cover. The trigger is the presence of seeds and/or other viable material of invasive species.

Restoration pathway R3B State 3 to 1

The Degraded State (3) has lost soil or vegetation attributes to the point that recovery to the Bunchgrass State (1) will require reclamation efforts, such as soil rebuilding, intensive mechanical treatments, and/or revegetation. Studies suggest (Whitford et al. 1989) that a mulch with a high carbon to nitrogen ratio, such as wood chips or bark, in low moisture scenarios can be beneficial for slow mobilization of plant-available nitrogen. Biochar may also be added to the system to improve Soil Organic Carbon (SOC) which should improve Cation Exchange Capacity (CEC), microbial activity, and hydrologic conductivity (Stavi 2012). The drivers for the restoration pathway are the removal of increaser species, restoration of native bunchgrass species, persistent management of invasives and shrubs, and proper grazing management. Without continued control, invasive and shrub species are likely to return (probably rapidly) due to the presence of seeds and/or other viable material in the soil and management-related increases in soil disturbance.

Restoration pathway R3A State 3 to 2

Since the bunchgrass plant community has been significantly reduced, restoration to the Altered State (2) is unlikely unless a seed source is available. If enough grass remains on the site, chemical and/or biological control, combined with proper grazing management, can reduce the amount of shrubs and invasive species and restore the site to the shortgrass community (2.2). Low-intensity fire can be utilized to reduce Wyoming big sagebrush competition and allow the reestablishment of grass species. Caution must be used when considering fire as a management tool on sites with fire tolerant shrubs such as rubber rabbitbrush, as these shrubs will sprout after a burn. Broom snakeweed and fringed sagewort may or may not re-sprout depending on conditions (USDA Forest Service, 2011).

Transition T3A

State 3 to 4

Invasive species can occupy the Degraded State (3) and drive it to the Invaded State (4). The Degraded State is at risk of this transition occurring if invasive seeds or viable material are present. The driver for this transition is the presence of critical population levels (more than 20 percent dry weight of invasive species). The trigger is the presence of seeds or viable material from invasive species. This state has sufficient bare ground that the transition could occur simply due to the presence or introduction of invasive seeds or viable material. This is particularly true of aggressive invasive species such as spotted knapweed. This transition could be assisted by overgrazing (failure to adjust stocking rate to declining forage production), a long-term lack of fire, or an extensive drought.

Transition T3B

State 3 to 5

5 percent canopy cover of conifer cover. The trigger is the presence of seeds and/or other viable material of invasive species.

Restoration pathway R4C

State 4 to 1

Restoration of the Invaded State (4) to the Reference State (1) requires substantial energy input. The drivers for the restoration pathway are the removal of invasive species, restoration of native bunchgrass species, persistent management of invasive species, and proper grazing management. Without continued control, invasive species are likely to return (probably rapidly) due to the presence of seeds and/or other viable material in the soil and management-related practices that increase soil disturbance. If invaded by conifer encroachment, treatment depends on the condition of the rangeland. See Plant Community 4.1 for alternative measures of restoration. Sites that have transitioned from the Degraded State (3) to the Invaded State (4) may be severely lacking in soil and vegetative properties that will allow for restoration to the Reference State. Hydrologic function damage may be irreversible, especially with accelerated gully erosion.

Restoration pathway R4B

State 4 to 2

If invasive species are removed before remnant populations of bunchgrass are drastically reduced, the invading state (4) can revert to its altered state. The driver for the reclamation pathway is weed management without reseeding. Continued Integrated Pest Management (IPM) will be required as many of the invasive species that can occupy the Invaded State have extended dormant seed life. The trigger is invasive species control.

Restoration pathway R4A

State 4 to 3

If invasive species are removed, the site could return to the Degraded State (3). Without sufficient remnant populations of preferred plants, the Invaded State (4) is not likely to return to any of the other states. The driver for the reclamation pathway is weed management without reseeding. The trigger is invasive species control. Due to a lack of ground cover, the invading species cause a significant increase in soil loss (Lacey et al. 1989).

Transition T4A

State 4 to 5

5 percent canopy cover of conifer cover. The trigger is the presence of seeds and/or other viable material of invasive species.

Restoration pathway R5A

State 5 to 1

Restoration efforts may simply focus on the removal of coniferous trees and shrubs to restore the Conifer Encroached State (5) to the reference state (1), depending on the level of conifer canopy cover and its impact on

rangeland health. If following and utilizing the phases established by Miller et al., management and restoration methods will vary. A majority of the conifer encroachment in MLRA 44B will fall into the early two phases of Miller's phases. When conifers are removed through brush management and/or prescribed fire, Phase I may reveal none-to-slight to moderate deviations from rangeland health. If mechanical removal of conifers is utilized, no grazing management is needed, assuming relatively conservative management had been used prior to treatment. If prescribed fire is utilized, short-term grazing deferment and/or rest are suggested. In a short period of time, removing a Phase I encroachment will return the site to its original state. Proactive pest management is encouraged. Phase II encroachment may require a more intensive mechanical removal of trees and shrubs, with prescribed fire not being a feasible method of control as this community may be at risk of catastrophic fire due to canopy density. Phase II displays a moderate departure from Reference, suggesting an overall instability of the site such as reduced herbaceous production, reduced functional/structural groups (e.g., reduced mid-statured bunchgrasses), increased rill frequency and length, and possibly more bare ground. Increased post-treatment grazing management may be necessary. Grazing management may be as simple as short-term growing season deferment; however, long-term rest may be necessary in the latter stages of Phase II encroachment. The latter stages of Phase II encroachment will likely require some short-term erosion mitigation, such as straw wattles, as well as range planting and/or critical area planting to re-establish any loss of native herbaceous plants, particularly mid-statured cool-season bunchgrasses. Phase III encroachment canopy cover resembles forested sites with larger trees and shrubs. Prior to any prescribed burning, forest management style tree removal (removal of woody debris and logs from the site) will be required to prevent the fire from burning too hot. The result of a prescribed fire on this site is typically unknown as seed sources of native herbaceous plants are usually limited to small patches. Since the Limy ecological site for 44B LRU 01 Subset A is a dry site, herbaceous plants will likely have been depleted under a Phase III encroachment. This means there is an opportunity for large areas of bare ground, increased rilling, and in some cases, gully erosion. Post-treatment will require range planting and/or critical area seeding, erosion control, pest management, and possibly soil carbon amendments (biochar). Grazing management (primarily rest) will be required to ensure the establishment of any new seedlings.

Restoration pathway R5B

State 5 to 2

The Conifer Encroached State (5) Phases I and II will generally resemble the Altered State (2) on this site. If following and utilizing the phases established by Miller et al., management and restoration methods will vary. A majority of the conifer encroachment in MLRA 44B will fall into the early two phases of Miller's phases. When conifers are removed through brush management and/or prescribed fire, Phase I may show none-to-slight to moderate deviations from rangeland health. If mechanical removal of conifers is utilized, no grazing management is needed, assuming relatively conservative management had been used prior to treatment. If prescribed fire is utilized, short-term grazing deferment and/or rest are suggested. In a short period of time, removing a Phase I encroachment will return the site to its original state. Proactive pest management is encouraged. Phase II encroachment may require a more intensive mechanical removal of trees and shrubs, with prescribed fire not being a feasible method of control as this community may be at risk of catastrophic fire due to canopy density. Phase II displays a moderate departure from Reference, suggesting an overall instability of the site such as reduced herbaceous production, reduced functional/structural groups (e.g., reduced mid-statured bunchgrasses), increased rill frequency and length, and possibly increased bare ground. Increased post-treatment grazing management may be necessary. Grazing management may be as simple as short-term growing season deferment; however, long-term rest may be necessary in the latter stages of Phase II encroachment. The latter stages of Phase II encroachment will likely require some short-term erosion mitigation such as straw wattles as well as range planting and/or critical area planting to re-establish any loss of native herbaceous plants, particularly mid-statured cool-season bunchgrasses. Phase III encroachment canopy cover resembles forested sites with larger trees and shrubs. Prior to any prescribed burning, forest management style tree removal (removal of woody debris and logs from the site) will be required to prevent the fire from burning too hot. The result of a prescribed fire on this site is typically unknown as seed sources of native herbaceous plants are usually limited to small patches. Since the Limy ecological site for 44B LRU 1 Subset A is a dry site, herbaceous plants will likely have been depleted under a Phase III encroachment. This means there is an opportunity for large areas of bare ground, increased rilling, and in some cases, gully erosion. Post-treatment will require range planting and/or critical area seeding, erosion control, pest management, and possibly soil carbon amendments (biochar). Grazing management (primarily rest) will be required to ensure the establishment of any new seedlings.

Restoration pathway R5C

State 5 to 3

The Conifer Encroached State (5) Phases I and II will generally resemble the Degraded State (2) on this site. If following and utilizing the phases established by Miller et al., management and restoration methods will vary. A majority of the conifer encroachment in MLRA 44B will fall into the early two phases of Miller's phases. When conifers are removed through brush management and/or prescribed fire, Phase I may show none-to-slight to moderate deviations from rangeland health. If mechanical removal of conifers is utilized, no grazing management is needed, assuming relatively conservative management had been used prior to treatment. If prescribed fire is utilized, short-term grazing deferment and/or rest are suggested. In a short period of time, removing a Phase I encroachment will return the site to its original state. Proactive pest management is encouraged. Phase II encroachment may require a more intensive mechanical removal of trees and shrubs, with prescribed fire not being a feasible method of control as this community may be at risk of catastrophic fire due to canopy density. Phase II displays a moderate departure from Reference, suggesting an overall instability of the site such as reduced herbaceous production, reduced functional/structural groups (e.g., reduced mid-statured bunchgrasses), increased rill frequency and length, and possibly increased bare ground. Increased post-treatment grazing management may be necessary. Grazing management may be as simple as short-term growing season deferment; however, long-term rest may be necessary in the latter stages of Phase II encroachment. The latter stages of Phase II encroachment will likely require some short-term erosion mitigation such as straw wattles as well as range planting and/or critical area planting to re-establish any loss of native herbaceous plants, particularly mid-statured cool-season bunchgrasses. Phase III encroachment canopy cover resembles forested sites with larger trees and shrubs. Prior to any prescribed burning, forest management style tree removal (removal of woody debris and logs from the site) will be required to prevent the fire from burning too hot. The result of a prescribed fire on this site is typically unknown as seed sources of native herbaceous plants are usually limited to small patches. Since the Limy ecological site for 44B LRU 1 Subset A is a dry site, herbaceous plants will likely have been depleted under a Phase III encroachment. This means there is an opportunity for large areas of bare ground, increased rilling, and in some cases, gully erosion. Post-treatment will require range planting and/or critical area seeding, erosion control, pest management, and possibly soil carbon amendments (biochar). Grazing management (primarily rest) will be required to ensure the establishment of any new seedlings.

Additional community tables

Table 10. Community 1.1 plant community composition

Group	Common Name	Symbol	Scientific Name	Annual Production (Kg/Hectare)	Foliar Cover (%)
Grass/Grasslike					
1	Cool Season Bunchgrasses			471–961	
	bluebunch wheatgrass	PSSP6	<i>Pseudoroegneria spicata</i>	224–757	–
	needle and thread	HECO26	<i>Hesperostipa comata</i>	135–482	–
	Indian ricegrass	ACHY	<i>Achnatherum hymenoides</i>	28–84	–
	green needlegrass	NAVI4	<i>Nassella viridula</i>	22–50	–
	squirreltail	ELEL5	<i>Elymus elymoides</i>	0–13	–
2	Shortgrasses/Rhizomatous Grasses/Grasslikes			87–179	
	needleleaf sedge	CADU6	<i>Carex duriuscula</i>	22–67	–
	prairie Junegrass	KOMA	<i>Koeleria macrantha</i>	34–67	–
	western wheatgrass	PASM	<i>Pascopyrum smithii</i>	34–67	–
	Sandberg bluegrass	POSE	<i>Poa secunda</i>	34–67	–
	thickspike wheatgrass	ELLA3	<i>Elymus lanceolatus</i>	34–67	–
	threadleaf sedge	CAFI	<i>Carex filifolia</i>	17–67	–
	plains reedgrass	CAMO	<i>Calamagrostis montanensis</i>	17–50	–
	sand dropseed	SPCR	<i>Sporobolus cryptandrus</i>	6–34	–
	Grass, native	2GN	<i>Grass, native</i>	11–34	–
	blue grama	BOGR2	<i>Bouteloua gracilis</i>	6–17	–

Forb					
3	Forbs			47–96	
	fleabane	ERIGE2	<i>Erigeron</i>	11–45	–
	scarlet globemallow	SPCO	<i>Sphaeralcea coccinea</i>	11–45	–
	bastard toadflax	COUM	<i>Comandra umbellata</i>	17–34	–
	American vetch	VIAM	<i>Vicia americana</i>	11–25	–
	stiffleaf penstemon	PEAR2	<i>Penstemon aridus</i>	6–25	–
	spiny phlox	PHHO	<i>Phlox hoodii</i>	11–25	–
	Forb, dicot, perennial	2FDP	<i>Forb, dicot, perennial</i>	6–25	–
	ballhead sandwort	ARCO5	<i>Arenaria congesta</i>	11–22	–
	milkvetch	ASTRA	<i>Astragalus</i>	0–22	–
	hairy false goldenaster	HEVI4	<i>Heterotheca villosa</i>	11–22	–
	desertparsley	LOMAT	<i>Lomatium</i>	11–22	–
	Forb, annual	2FA	<i>Forb, annual</i>	0–6	–
Shrub/Vine					
4	Shrubs			67–137	
	yellow rabbitbrush	CHVI8	<i>Chrysothamnus viscidiflorus</i>	11–101	–
	winterfat	KRLA2	<i>Krascheninnikovia lanata</i>	24–84	–
	Gardner's saltbush	ATGA	<i>Atriplex gardneri</i>	11–67	–
	Wyoming big sagebrush	ARTRW8	<i>Artemisia tridentata</i> ssp. <i>wyomingensis</i>	6–67	–
	prairie sagewort	ARFR4	<i>Artemisia frigida</i>	0–56	–
	broom snakeweed	GUSA2	<i>Gutierrezia sarothrae</i>	0–35	–
	black sagebrush	ARNO4	<i>Artemisia nova</i>	0–34	–
	rubber rabbitbrush	ERNA10	<i>Ericameria nauseosa</i>	0–34	–
	plains pricklypear	OPPO	<i>Opuntia polyacantha</i>	0–11	–
	Shrub, other	2S	<i>Shrub, other</i>	0–11	–

Table 11. Community 1.2 plant community composition

Group	Common Name	Symbol	Scientific Name	Annual Production (Kg/Hectare)	Foliar Cover (%)
Grass/Grasslike					
1	Cool Season Bunchgrasses			392–785	
	bluebunch wheatgrass	PSSP6	<i>Pseudoroegneria spicata</i>	56–392	–
	needle and thread	HECO26	<i>Hesperostipa comata</i>	112–336	–
	Indian ricegrass	ACHY	<i>Achnatherum hymenoides</i>	45–56	–
	green needlegrass	NAVI4	<i>Nassella viridula</i>	45–56	–
	squirreltail	ELEL5	<i>Elymus elymoides</i>	0–28	–
2	Shortgrasses/Rhizomatous Grasses/Grasslike			56–112	
	threadleaf sedge	CAFI	<i>Carex filifolia</i>	22–35	–
	thickspike wheatgrass	ELLA3	<i>Elymus lanceolatus</i>	25–35	–
	western wheatgrass	PASM	<i>Pascopyrum smithii</i>	25–35	–
	prairie Junegrass	KOMA	<i>Koeleria macrantha</i>	22–35	–
	Sandberg bluegrass	POSE	<i>Poa secunda</i>	25–35	–
	sand dropseed	SPCR	<i>Sporobolus cryptandrus</i>	0–35	–

	Grass, perennial	2GP	<i>Grass, perennial</i>	25–35	–
	blue grama	BOGR2	<i>Bouteloua gracilis</i>	11–34	–
	plains reedgrass	CAMO	<i>Calamagrostis montanensis</i>	22–34	–
	needleleaf sedge	CADU6	<i>Carex duriuscula</i>	25–34	–
Forb					
3	Forb			22–56	
	ballhead sandwort	ARCO5	<i>Arenaria congesta</i>	17–22	–
	milkvetch	ASTRA	<i>Astragalus</i>	0–22	–
	bastard toadflax	COUM	<i>Comandra umbellata</i>	17–22	–
	fleabane	ERIGE2	<i>Erigeron</i>	17–22	–
	buckwheat	ERIOG	<i>Eriogonum</i>	17–22	–
	hairy false goldenaster	HEVI4	<i>Heterotheca villosa</i>	17–22	–
	desertparsley	LOMAT	<i>Lomatium</i>	17–22	–
	stiffleaf penstemon	PEAR2	<i>Penstemon aridus</i>	17–22	–
	spiny phlox	PHHO	<i>Phlox hoodii</i>	17–22	–
	spiny phlox	PHHO	<i>Phlox hoodii</i>	17–22	–
	Forb, dicot, perennial	2FDP	<i>Forb, dicot, perennial</i>	0–17	–
	Forb, annual	2FA	<i>Forb, annual</i>	0–11	–
Shrub/Vine					
4	Shrub			90–168	
	Wyoming big sagebrush	ARTRW8	<i>Artemisia tridentata</i> ssp. <i>wyomingensis</i>	67–90	–
	yellow rabbitbrush	CHVI8	<i>Chrysothamnus viscidiflorus</i>	45–90	–
	prairie sagewort	ARFR4	<i>Artemisia frigida</i>	0–56	–
	broom snakeweed	GUSA2	<i>Gutierrezia sarothrae</i>	0–56	–
	winterfat	KRLA2	<i>Krascheninnikovia lanata</i>	22–56	–
	Gardner's saltbush	ATGA	<i>Atriplex gardneri</i>	22–56	–
	black sagebrush	ARNO4	<i>Artemisia nova</i>	0–34	–
	rubber rabbitbrush	ERNA10	<i>Ericameria nauseosa</i>	0–28	–
	plains pricklypear	OPPO	<i>Opuntia polyacantha</i>	0–17	–
	Shrub, other	2S	<i>Shrub, other</i>	0–11	–

Animal community

The Limy ecological site provides a variety of wildlife habitats for an array of species. Prior to the settlement of this area, large herds of antelope, elk, and bison roamed. Though the bison have been replaced, mostly with domesticated livestock, elk and antelope still frequently utilize this largely intact landscape for winter habitat in areas adjacent to forests.

The relatively high grass component of the Reference Community provides excellent nesting cover for multiple neotropical migratory birds that select for open grasslands, such as the long-billed curlew and McCown's longspur.

Greater sage grouse may be present on sites with suitable habitat, typically requiring a minimum of 15 percent sagebrush canopy cover (Wallestad 1975). The Bluebunch Wheatgrass Community (1.1) is likely to have minimal sage grouse presence given its low sagebrush canopy cover. However, the potentially diverse forb component of the Reference State may provide important early-season (spring) foraging habitat for the greater sage-grouse. Other communities on the site with sufficient sagebrush cover may harbor sage grouse populations, specifically Community 2.1 (the Needle and Thread Community), where big sagebrush populations are under a reduced fire

regime. Also, as sagebrush canopy cover increases under Altered States 2.1 and 2.2 and, to a limited extent, under Degraded State 3.1, pygmy rabbit, Brewer's sparrow, and mule deer use may also increase.

Managed livestock grazing is suitable on this site due to the potential to produce an abundance of high-quality forage. This is often a preferred site for grazing by livestock, and animals tend to congregate in these areas. To maintain the productivity of the Limy site, grazing on adjoining sites with less production must be managed carefully to be sure utilization on this site is not excessive. Management objectives should include maintenance or improvement of the native plant community. Careful management of the timing and duration of grazing is important. Shorter grazing periods and adequate deferment during the growing season are recommended for plant maintenance, health, and recovery. According to McLean et al., early-season defoliation of bluebunch wheatgrass can result in high mortality and reduced vigor in plants. They also suggest, based on prior studies, that regrowth is necessary before dormancy to reduce bluebunch injury.

Since needle and thread normally matures earlier than bluebunch wheatgrass and produces a sharp awn, this species is usually avoided after seed set. Changing the grazing season of use will help utilize needle and thread more efficiently while preventing overuse of bluebunch wheatgrass.

The grazing season has a greater impact on winterfat than the intensity of grazing. Late winter or early spring grazing is detrimental. However, early winter grazing may actually be beneficial (Blaisdell 1984).

Continual non-prescribed grazing of this site will be detrimental, will alter the plant composition and production over time, and will result in the transition to the Altered State. The transition to other states will depend on the duration of poorly managed grazing as well as other circumstances such as weather conditions and fire frequency.

The Altered State can degrade further to the Degraded Shortgrass State or the Invaded State. Management should focus on grazing management strategies that will prevent further degradation, such as seasonal grazing deferment or winter grazing where feasible. Communities within this state are still stable and healthy under proper management. Forage quantity and/or quality may be substantially decreased from the Reference State.

Grazing is possible in the Invaded State. Invasive species are generally less palatable than native grasses. Forage production is typically greatly reduced in this state. Due to the aggressive nature of invasive species, sites in the Invaded State face an increased risk of further degradation by invasive-dominant communities. Grazing has to be carefully managed to avoid further soil loss and degradation and possible livestock health issues.

Prescriptive grazing can be used to manage invasive species. In some instances, carefully targeted grazing (sometimes in combination with other treatments) can reduce or maintain the species composition of invasive species. Grazing may be possible in a degraded state, but it is generally not economically or environmentally sustainable.

Hydrological functions

The hydrologic cycle functions best in the Bunchgrass State (1) with good infiltration and deep percolation of rainfall; however, the cycle degrades as the vegetation community declines. Rapid rainfall infiltration, high soil organic matter, good soil structure, and good porosity accompany high bunchgrass canopy cover (Thurow et al. 1986). High ground cover reduces raindrop impact on the soil surface, which keeps erosion and sedimentation transport low. Water leaving the site will have a minimal sediment load, which allows for high water quality in associated streams. High rates of infiltration will allow water to move below the rooting zone during periods of heavy rainfall. The Bluebunch Wheatgrass Community (1.1) should have no rills or gullies present, and drainage ways should be vegetated and stable. Water flow patterns, if present, will be barely observable. Plant pedestals are essentially nonexistent. Plant litter remains in place and is not moved by wind or water.

Improper grazing management results in a community shift to the Mixed Bunchgrass Community (1.2). This plant community has a similar canopy cover, but the bare ground will be less than 15 percent. Therefore, the hydrologic cycle is functioning at a level similar to the water cycle in the Bluebunch Wheatgrass Community (1.1). When the Mixed Bunchgrass community (1.2) is compared to the Community (1.1), infiltration rates are slightly reduced and surface runoff is slightly higher.

In the Shortgrass Community (2.2), Degraded State (3), and Invaded State (4), canopy and ground cover are

greatly reduced compared to the Bunchgrass State (1), which impedes the hydrologic cycle. Infiltration will decrease and runoff will increase due to reduced ground cover, the presence of shallow-rooted species, rainfall splash, soil capping, reduced organic matter, and poor structure. Sparse ground cover and decreased infiltration can combine to increase the frequency and severity of flooding within a watershed. Soil erosion is accelerated, the quality of surface runoff is poor, and sedimentation increases. (McCalla et al., 1984)

Based on field observations for a typical Limy site with 11.2 inches of precipitation, the Rangeland Hydrology and Erosion Model (RHEM) shows that reductions in foliar canopy, increases in basal bare ground, and reductions in basal area mean that the Altered and the Degraded State will likely erode 200 and 442 percent, respectively, more soil than the reference during rainfall events.

Recreational uses

This site provides some limited recreational opportunities for hiking, horseback riding, big game hunting, and upland bird hunting. Some plants have flowers that appeal to photographers. This site provides valuable open space.

Wood products

This site does not offer opportunity for wood products industry.

Inventory data references

Information presented was derived from the site's Range Site Description (Limy 9 –14" P.Z., Northern Rocky Mountain Valleys, South, East of Continental Divide), NRCS clipping data, literature, field observations, and personal contacts with range-trained personnel (i.e., used professional opinion of agency specialists, observations of land managers, and outside scientists).

References

- Walker, L.R. and S.D. Smith. 1997. Impacts of invasive plants on community and ecosystem properties. Pages 69–86 in *Assessment and management of plant invasions*. Springer, New York, NY.
- Wambolt, C. and G. Payne. 1986. An 18-Year Comparison of Control Methods for Wyoming Big Sagebrush in Southwestern Montana. *Journal of Range Management* 39:314–319.
- West, N.E. 1994. Effects of Fire on Salt-Desert shrub rangelands. *Proceedings--Ecology and Management of Annual Rangelands: 1992 May 18-22*. Boise ID General Technical Report INT-GTR-313.. USDA Forest Service Intermountain Research Station. 71–74.
- Whitford, W.G., E.F. Aldon, D.W. Freckman, Y. Steinberger, and L.W. Parker. 1989. Effects of Organic Amendments on Soil Biota on a Degraded Rangeland. *Journal of Range Management* 41:56–60.
- Wilson, A.M., G.A. Harris, and D.H. Gates. 1966. Cumulative Effects of Clipping on Yield of Bluebunch wheatgrass. *Journal of Range Management* 19:90–91.
- . 1966. Fire Effects Information System. <http://www.fs.fed.us/database/feis/>.
- . 2021 (Date accessed). USDA PLANTS Database. <http://plants.usda.gov>.
- Arno, S.F. and G.E. Gruell. 1982. Fire History at the Forest-Grassland Ecotone in Southwestern Montana. *Journal of Range Management* 36:332–336.

- Barrett, H. 2007. *Western Juniper Management: A Field Guide*.
- Bestelmeyer, B., J.R. Brown, J.E. Herrick, D.A. Trujillo, and K.M. Havstad. 2004. Land Management in the American Southwest: a state-and-transition approach to ecosystem complexity. *Environmental Management* 34:38–51.
- Bestelmeyer, B. and J. Brown. 2005. State-and-Transition Models 101: A Fresh look at vegetation change.
- Blaisdell, J.P. 1958. Seasonal development and yield of native plants on the Upper Snake River Plains and their relation to certain climate factors.
- Blaisdell, J.P. and R.C. Holmgren. 1984. *Managing Intermountain Rangelands--Salt-Desert Shrub Ranges*. General Tech Report INT-163. USDA Forest Service, Intermountain Forest and Range Experiment Station, Ogden, UT. 52.
- Bunting, S.C., B.M. Kilgore, and C.L. Bushey. 1987. *Guidelines for Prescribe burning sagebrush-grass rangelands in the Northern Great Basin*. General Technical Report INT-231. USDA Forest Service Intermountain Research Station, Ogden, UT. 33.
- Colberg, T.J. and J.T. Romo. 2003. Clubmoss effects on plant water status and standing crop. *Journal of Range Management* 56:489–495.
- Daubenmire, R. 1970. *Steppe vegetation of Washington*.
- DiTomaso, J.M. 2000. Invasive weeds in Rangelands: Species, Impacts, and Management. *Weed Science* 48:255–265.
- Dormaar, J.F., B.W. Adams, and W.D. Willms. 1997. Impacts of rotational grazing on mixed prairie soils and vegetation. *Journal of Range Management* 50:647–651.
- Hobbs, J.R. and S.E. Humphries. 1995. An integrated approach to the ecology and management of plant invasions. *Conservation Biology* 9:761–770.
- Kuchler, A.W. 1964. *Potential natural vegetation of the conterminous United States*.
- Lacey, J.R., C.B. Marlow, and J.R. Lane. 1989. Influence of Spotted knapweed (*Centaurea maculosa*) on surface runoff and sediment yield.. *Weed Technology* 3:627–630.
- Lesica, P. and S.V. Cooper. 1997. *Presettlement vegetation of Southern Beaverhead County, MT*.
- Manske, L.L. 1980. *Habitat, phenology, and growth of selected sandhills range plants*.
- Masters, R. and R. Sheley. 2001. Principles and practices for managing rangeland invasive plants. *Journal of Range Management* 38:21–26.

- McCalla, G.R., W.H. Blackburn, and L.B. Merrill. 1984. Effects of Livestock Grazing on Infiltration Rates of the Edwards Plateau of Texas. *Journal of Range Management* 37:265–269.
- McLean, A. and S. Wikeem. 1985. Influence of season and intensity of defoliation on bluebunch wheatgrass survival and vigor in southern British Columbia. *Journal of Range Management* 38:21–26.
- Miller, R.F., T.J. Svejcar, and J.A. Rose. 2000. Impacts of western juniper on plant community composition and structure. *Journal of Range Management* 53:574–585.
- Moulton, G.E. and T.W. Dunlay. 1988. *The Journals of the Lewis and Clark Expedition*. Pages in University of Nebraska Press.
- Mueggler, W.F. and W.L. Stewart. 1980. *Grassland and Shrubland Habitat Types of Western Montana*.
- Pelant, M., P. Shaver, D.A. Pyke, and J.E. Herrick. 2005. *Interpreting Indicators of Rangeland Health*.
- Pellant, M. and L. Reichert. 1984. Management and Rehabilitation of a burned winterfat community in Southwestern Idaho. *Proceedings--Symposium on the biology of Atriplex and related Chenopods*. 1983 May 2-6; Provo UT General Technical Report INT-172.. USDA Forest Service Intermountain Forest and Range Experiment Station. 281–285.
- Pitt, M.D. and B.M. Wikeem. 1990. Phenological patterns and adaptations in an *Artemisia/Agropyron* plant community. *Journal of Range Management* 43:350–357.
- Pokorny, M.L., R. Sheley, C.A. Zabinski, R. Engel, T.J. Svejcar, and J.J. Borkowski. 2005. Plant Functional Group Diversity as a Mechanism for Invasion Resistance.
- Ross, R.L., E.P. Murray, and J.G. Haigh. July 1973. *Soil and Vegetation of Near-pristine sites in Montana*.
- Schoeneberger, P.J. and D.A. Wysocki. 2017. *Geomorphic Description System, Version 5.0.*
- Smoliak, S., R.L. Ditterlin, J.D. Scheetz, L.K. Holzworth, J.R. Sims, L.E. Wiesner, D.E. Baldrige, and G.L. Tibke. 2006. *Montana Interagency Plant Materials Handbook*.
- Stavi, I. 2012. The potential use of biochar in reclaiming degraded rangelands. *Journal of Environmental Planning and Management* 55:1–9.
- Stringham, T.K., W.C. Kreuger, and P.L. Shaver. 2003. State and Transition Modeling: an ecological process approach. *Journal of Range Management* 56:106–113.
- Stringham, T.K. and W.C. Krueger. 2001. *States, Transitions, and Thresholds: Further refinement fro rangeland applications*.
- Sturm, J.J. 1954. *A study of a relict area in Northern Montana*. University of Wyoming, Laramie 37.

Thurrow, T.L., Blackburn W. H., and L.B. Merrill. 1986. Impacts of Livestock Grazing Systems on Watershed. Page in Rangelands: A Resource Under Siege: Proceedings of the Second International Rangeland Congress.

Various NRCS Staff. 2013. National Range and Pasture Handbook.

Contributors

Grant Petersen
Barb Landgraf-Gibbons
Abe Clark
Synergy Resource Solutions

Approval

Kirt Walstad, 9/11/2023

Rangeland health reference sheet

Interpreting Indicators of Rangeland Health is a qualitative assessment protocol used to determine ecosystem condition based on benchmark characteristics described in the Reference Sheet. A suite of 17 (or more) indicators are typically considered in an assessment. The ecological site(s) representative of an assessment location must be known prior to applying the protocol and must be verified based on soils and climate. Current plant community cannot be used to identify the ecological site.

Author(s)/participant(s)	Grant Petersen
Contact for lead author	grant.petersen@mt.usda.gov
Date	02/20/2019
Approved by	Kirt Walstad
Approval date	
Composition (Indicators 10 and 12) based on	Annual Production

Indicators

1. **Number and extent of rills:** No Rills Present

2. **Presence of water flow patterns:** Water flow patterns are rare in the reference condition. If present, they are most likely to occur on steeper slopes (10-15%) and are inconspicuous, disconnected, and very short in length.

3. **Number and height of erosional pedestals or terracettes:** No Pedestals or Terracettes present

4. **Bare ground from Ecological Site Description or other studies (rock, litter, lichen, moss, plant canopy are not bare ground):** Bare ground is between 10-15 percent.

5. **Number of gullies and erosion associated with gullies:** No Gullies Present

-
6. **Extent of wind scoured, blowouts and/or depositional areas:** Wind scoured, or depositional areas are not evident in the reference condition.
-
7. **Amount of litter movement (describe size and distance expected to travel):** Movement of fine herbaceous litter may occur within less than a foot from where it originated.
-
8. **Soil surface (top few mm) resistance to erosion (stability values are averages - most sites will show a range of values):** Soil Surface Stable with Stability Ratings of 4-6 (both under canopy and bare). Biotic crusts and or root mats may be present
-
9. **Soil surface structure and SOM content (include type of structure and A-horizon color and thickness):** Granular to subangular blocky, A horizon 2-4 inches (5-10cm) thick, light to dark grey-brown color (Value of 6 or less, Chroma 3 or less) Official Series Description (OSD) for characteristic range.
-
10. **Effect of community phase composition (relative proportion of different functional groups) and spatial distribution on infiltration and runoff:** Evenly distributed across the site, bunchgrasses improve infiltration while rhizomatous grass protects the surface from runoff forces. The Limy ecological site is well drained and has a high infiltration rate. An even distribution of Mid-Statured Bunchgrasses (60-70%), Rhizomatous grasses (5-10%) along with a mix of Shortgrasses (5-15%), Forbs (1-10%) and Shrubs (1-10%).
-
11. **Presence and thickness of compaction layer (usually none; describe soil profile features which may be mistaken for compaction on this site):** Not Present
-
12. **Functional/Structural Groups (list in order of descending dominance by above-ground annual-production or live foliar cover using symbols: >>, >, = to indicate much greater than, greater than, and equal to):**
- Dominant: Mid-Statured, cool season, perennial bunchgrasses
- Sub-dominant: cool season shortgrasses ≥ Rhizomatous grasses ≥ perennial forbs = shrubs
- Other: Native annual grasses and forbs
- Additional:
-
13. **Amount of plant mortality and decadence (include which functional groups are expected to show mortality or decadence):** Mortality in herbaceous species is not evident. Species with bunch growth forms may have some natural mortality in centers.
-
14. **Average percent litter cover (%) and depth (in):** Total litter cover ranges from 25 to 30%. Most litter is irregularly distributed on the soil surface and is not at a measurable depth.

-
15. **Expected annual annual-production (this is TOTAL above-ground annual-production, not just forage annual-production):** Average annual production is 975. Low: 600 High 1225 lbs per acre. Production varies based on effective precipitation and natural variability of soil properties for this ecological site.
-

16. **Potential invasive (including noxious) species (native and non-native). List species which BOTH characterize degraded states and have the potential to become a dominant or co-dominant species on the ecological site if their future establishment and growth is not actively controlled by management interventions. Species that become dominant for only one to several years (e.g., short-term response to drought or wildfire) are not invasive plants. Note that unlike other indicators, we are describing what is NOT expected in the reference state for the ecological site:** SPotential invasive (including noxious) species (native and non-native). Invasive species on this ecological site include (but not limited to) annual brome spp., spotted knapweed, yellow toadflax, leafy spurge, ventenata, crested wheatgrass

Native species with the ability to indicate degradation however species presence alone does not imply degradation:
Sandberg bluegrass (*Poa secunda*), Big sagebrush (*Artemisia tridentata*), Three-tip sagebrush (*Artemisia tripartita*), Broom snakeweed (*Gutierrezia sarothrae*), Rubber rabbitbrush (*Ericameria nauseosa*), Yellow rabbitbrush (*Chrysothamnus viscidiflorus*), Rocky Mountain Juniper (*Juniperus scopulorum*), Douglas fir (*Psuedotsuga menziesii*)

17. **Perennial plant reproductive capability:** In the reference condition, all plants are vigorous enough for reproduction either by seed or rhizomes in order to balance natural mortality with species recruitment. Density of plants indicates that plants reproduce at level sufficient to fill available resource.
-