

Ecological site EX044B01A134

Shallow to Gravel (SwGr) LRU 01 Subset A

Last updated: 9/08/2023
Accessed: 05/05/2024

General information

Provisional. A provisional ecological site description has undergone quality control and quality assurance review. It contains a working state and transition model and enough information to identify the ecological site.

MLRA notes

Major Land Resource Area (MLRA): 044B—Central Rocky Mountain Valleys

Major Land Resource Area (MLRA) 44B, Central Rocky Mountain Valleys, is nearly 3.7 million acres of southwest Montana and borders two MLRAs: 43B Central Rocky Mountains and Foothills and 46 Northern and Central Rocky Mountain Foothills.

The major watersheds of this MLRA are those of the Missouri and Yellowstone Rivers and their associated headwaters such as the Beaverhead, Big Hole, Jefferson, Ruby, Madison, Gallatin, and Shields Rivers. These waters allow for extensive irrigation for crop production in an area that would generally only be compatible with rangeland and grazing. The Missouri River and its headwaters are behind several reservoirs that supply irrigation water, hydroelectric power, and municipal water. Limited portions of the MLRA are west of the Continental Divide along the Clark Fork River.

The primary land use of this MLRA is production agriculture (grazing, small grain production, and hay), but there is some limited mining. Urban development is high with large expanses of rangeland converted to subdivisions for a rapidly growing population.

The MLRA consists of one Land Resource Unit (LRU) and seven climate based LRU subsets. These subsets are based on a combination of Relative Effective Annual Precipitation (REAP) and frost free days. Each subset expresses a distinct set of plants that differentiate it from other LRU subsets. Annual precipitation ranges from a low of 9 inches to a high near 24 inches. The driest areas tend to be in the valley bottoms of southwest Montana in the rain shadow of the mountains. The wettest portions tend to be near the edge of the MLRA at the border with MLRA 43B. Frost free days also vary widely from less than 30 days in the Big Hole Valley to around 110 days in the warm valleys along the Yellowstone and Missouri Rivers.

The plant communities of the MRLA are highly variable, but the dominant community is a cool-season grass and shrub-steppe community. Warm-season grasses have an extremely limited extent in this MLRA. Most subspecies of big sagebrush are present, to some degree, across the MLRA.

LRU notes

MLRA 44B has one LRU that covers the entire MLRA. The LRU has been broken into seven climate subsets based on a combination of Relative Effective Annual Precipitation (REAP) and frost free days. Each combination of REAP and frost free days results in a common plant community that is shared across the subset. Each subset is giving a letter designation of A through F for sites that do not receive additional water and Y for sites that receive additional water.

LRU 01 Subset A has a REAP of nine to 14 inches (228.6-355.6mm) with a frost free days range of 70 to 110 days. This combination of REAP and frost free days results in a nearly treeless sagebrush steppe landscape.

The soil moisture regime is Ustic, dry that borders on Aridic and has a Frigid soil temperature regime.

Classification relationships

Mueggler and Stewart. 1980. Grassland and Shrubland habitat types of Western Montana

1. *Stipa comata/Bouteloua gracilis* h.t.
2. *Agropyron spicatum/Bouteloua gracilis* h.t.

Montana Natural Heritage Program Vegetation Classification

1. *Stipa comata - Bouteloua gracilis* Herbaceous Vegetation (STICOM – BOUGRA) Needle and thread/Blue grama

Natural Heritage Conservation Rank-G5 / S5

Edition / Author- 99-11-16 / S.V. Cooper,

EPA Ecoregions of Montana, Second Edition:

Level I: Northwestern Forested Mountains

Level II: Western Cordillera

Level III: Middle Rockies & Northern Great Plains

Level IV: Paradise Valley

Townsend Basin

Dry Intermontane Sagebrush Valleys

Shield-Smith Valleys

National Hierarchical Framework of Ecological Units:

Domain: Dry

Division: M330 – Temperate Steppe Division – Mountain Provinces

Province: M332 –Middle Rocky Mountain Steppe – Coniferous Forest – Alpine Meadow

Section: M332D – Belt Mountains Section

M332E – Beaverhead Mountains Section

Subsection: M332Ej – Southwest Montana Intermontane Basins and Valleys

M332Dk – Central Montana Broad Valleys

Ecological site concept

The Shallow to Gravel ecological site is an upland site formed from residuum, colluvium, or slope alluvium. It is moderately deep to very deep and has no root-restrictive layers within 20 inches (50cm). The surface of the site has less than 15 percent stone or boulder cover. The Shallow to Gravel ecological site is sandy skeletal, with greater than 35 percent rock fragments in the 10 to 20-inch depth. Soil surface textures are loamy sand to sand. The site does not have a saline or saline-sodic influence and is not strongly or violently effervescent within four inches of the mineral surface.

Associated sites

EX044B01A136	Shallow Loamy (SwLo) LRU 01 Subset A The Shallow Loamy ecological site is a neighboring site located on the landscape position directly above the Shallow to Gravel site.
EX044B01A036	Droughty (Dr) LRU 01 Subset A The Droughty ecological site is a neighboring site on the landscape. They often share landscape position.

Similar sites

EX044B01A036	Droughty (Dr) LRU 01 Subset A The Droughty ecological site is a neighboring site on the landscape, but it expresses a finer texture of soil with increased production over the Shallow to Gravel site.
--------------	--

Table 1. Dominant plant species

Tree	Not specified
Shrub	(1) <i>Artemisia tridentata ssp. wyomingensis</i> (2) <i>Chrysothamnus viscidiflorus</i>
Herbaceous	(1) <i>Pseudoroegneria spicata</i> (2) <i>Hesperostipa comata</i>

Legacy ID

R044BA134MT

Physiographic features

This ecological site most often occurs on the shoulder and summit positions of hills and escarpments. Slopes range from 0 to 45 percent, but are rarely greater than 15 percent.

Table 2. Representative physiographic features

Landforms	(1) Intermontane basin > Hill (2) Intermontane basin > Escarpment
Runoff class	Low to medium
Elevation	1,463–1,981 m
Slope	0–15%
Water table depth	152 cm
Aspect	Aspect is not a significant factor

Table 3. Representative physiographic features (actual ranges)

Runoff class	Not specified
Elevation	Not specified
Slope	0–45%
Water table depth	Not specified

Climatic features

The Central Rocky Mountain Valleys MLRA has a continental climate. Fifty to sixty percent of the annual long-term average total precipitation falls between May and August. Most of the precipitation in the winter is snow on frozen ground. Average precipitation for LRU 01 Subset A is 12 inches (305mm) and the frost-free period averages 78 days. Precipitation is highest in May and June. Some of Montana's driest areas are located in sheltered mountain valleys, because of the rain-shadow effects on the leeward side of some ranges.

Table 4. Representative climatic features

Frost-free period (characteristic range)	42-90 days
Freeze-free period (characteristic range)	101-120 days
Precipitation total (characteristic range)	254-330 mm
Frost-free period (actual range)	38-110 days
Freeze-free period (actual range)	70-131 days
Precipitation total (actual range)	229-356 mm
Frost-free period (average)	78 days
Freeze-free period (average)	111 days

Precipitation total (average)

305 mm

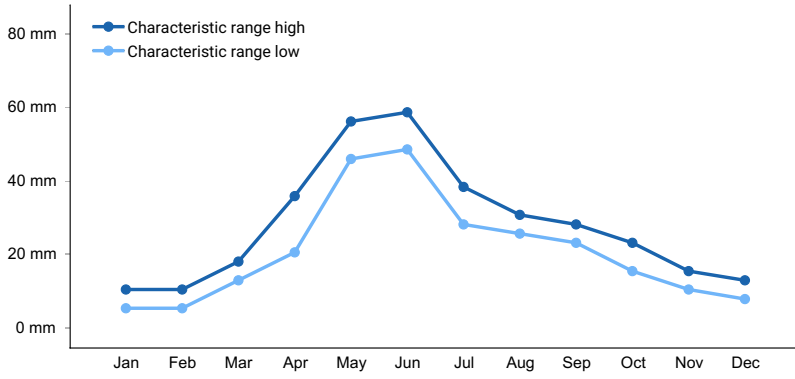

Figure 1. Monthly precipitation range

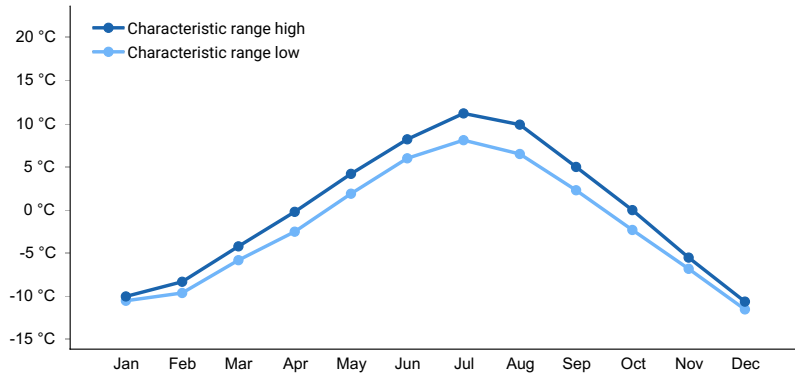

Figure 2. Monthly minimum temperature range

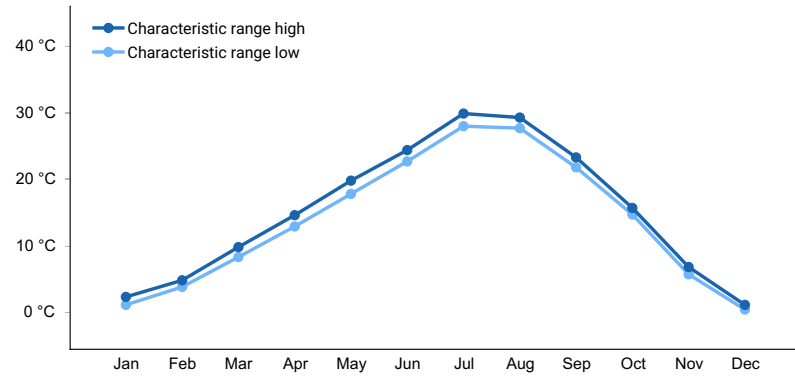

Figure 3. Monthly maximum temperature range

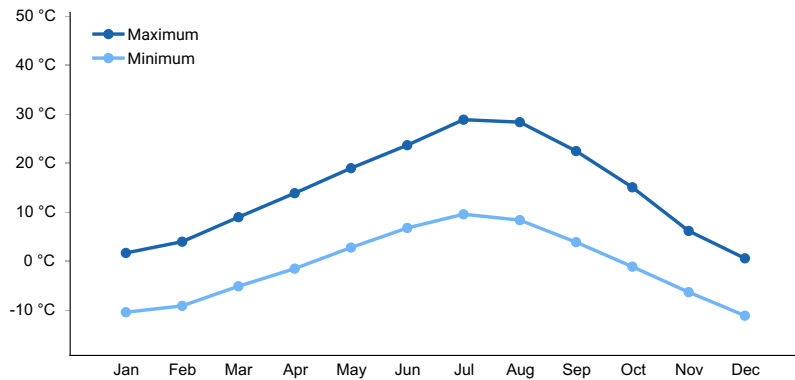

Figure 4. Monthly average minimum and maximum temperature

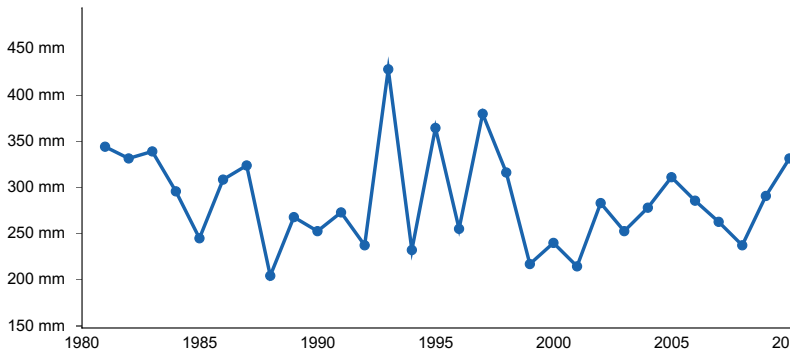

Figure 5. Annual precipitation pattern

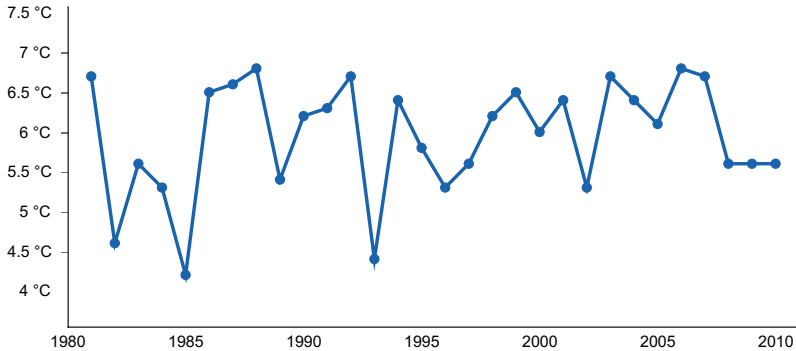

Figure 6. Annual average temperature pattern

Climate stations used

- (1) DILLON AP [USW00024138], Dillon, MT
- (2) HELENA RGNL AP [USW00024144], Helena, MT
- (3) DILLION U OF MONTANA WESTERN [USC00242409], Dillon, MT
- (4) GLEN 2 E [USC00243570], Dillon, MT
- (5) ENNIS [USC00242793], Ennis, MT
- (6) BOULDER [USC00241008], Boulder, MT
- (7) GARDINER [USC00243378], Gardiner, MT
- (8) TOWNSEND [USC00248324], Townsend, MT
- (9) TRIDENT [USC00248363], Three Forks, MT
- (10) TWIN BRIDGES [USC00248430], Sheridan, MT
- (11) WHITE SULPHUR SPRNGS 2 [USC00248930], White Sulphur Springs, MT

Influencing water features

No influencing water features.

Wetland description

This site not associated with wetlands.

Soil features

These soils are moderately deep to very deep and excessively drained to well drained. These soils are formed from alluvium. The soil is composed of sandy-skeletal material (rock fragments account for more than 35 percent of the volume in the 10 to 20 inch layer). This skeletal material decreases the water-holding capacity of the site. Typically, soil surface textures consist of loam, sandy loam, and loamy sand (to a limited extent). Soils are also typically gravelly or cobbly. Common soil series are Beaverell, Thessvo, and Scravo. These soils may exist across multiple ecological sites due to natural variations in slope, texture, rock fragments, and pH. An onsite soil pit and the most current ecological site key are required to classify an ecological site.

Table 5. Representative soil features

Parent material	(1) Alluvium–igneous, metamorphic and sedimentary rock
Surface texture	(1) Gravelly loam (2) Sandy loam (3) Loamy sand
Family particle size	(1) Sandy-skeletal
Drainage class	Well drained to somewhat excessively drained
Permeability class	Moderate to very rapid
Soil depth	152 cm
Surface fragment cover <=3"	0–24%
Surface fragment cover >3"	0–15%
Calcium carbonate equivalent (0-101.6cm)	0–30%
Electrical conductivity (0-101.6cm)	0 mmhos/cm
Soil reaction (1:1 water) (0-101.6cm)	6.6–8.4
Subsurface fragment volume <=3" (25.4-50.8cm)	15–70%
Subsurface fragment volume >3" (25.4-50.8cm)	0–40%

Ecological dynamics

The Shallow to Gravel (SwGr) ecological site Reference State is a collection of two plant communities dominated by bluebunch wheatgrass (*Pseudoroegneria spicata*), thickspike wheatgrass (*Elymus lanceolatus*), and needle and thread (*Hesperostipa comata*). Subdominant species include Sandberg bluegrass (*Poa secunda*) and limited Wyoming big sagebrush (*Artemisia tridentata* ssp. *wyomingensis*). This potential is suggested by investigations showing a predominance of perennial grasses on near-pristine range sites (Ross et al., 1973).

The driving force of change in this ecological site is grazing; however, other influences such as fire and climate affect the plant communities. As the Reference State degrades (triggered by the reduction or absence of bluebunch wheatgrass), the plant community transitions to another state. Which state the Reference transitions occur in is often dictated by the timing, duration, and intensity of the disturbance. These potential changes in the community can have a profound impact on the 17 indicators of rangeland health, such as bare ground, production, and site stability. See the Rangeland Health Worksheet and Interpreting Indicators of Rangeland Health Handbook for more information.

Historical records indicate that, prior to the introduction of livestock (cattle and sheep) during the late 1800s, elk and bison grazed this ecological site. Due to bison's nomadic nature and herd structure, grazed areas received periodic high intensity, short duration grazing pressure. The gold boom in the 1860s brought the first herds of livestock overland from Texas, and homesteaders began settling the area. During this time, cattle were the primary domestic grazers in the area. In the 1890s, Montana sheep production began to increase and dominated the livestock industry until the 1930s. Since the 1930s, cattle production has dominated the livestock industry in the region (Wyckoff and Hansen 2001).

Natural and prescribed fire, both used by indigenous peoples, were major ecological drivers of not only this ecological site but the entire MLRA. Indigenous peoples have utilized fire on this ecological site for thousands of years prior to European settlement as a means to move wildlife populations for harvest (Roos, Christopher I., et al. 2018). Fire tended to restrict tree and shrub growth to small patches and promote an herbaceous plant community. The natural fire return interval was highly variable, but it was likely shorter than 30 years. With the historically recent (since 1910) suppression of fire, shrubs and coniferous trees have increased significantly.

Some of the major invasive species that can occur on this site include spotted knapweed (*Centaurea stoebe*), Dalmatian toadflax (*Linaria dalmatica*), leafy spurge (*Euphorbia esula*), and cheatgrass (*Bromus tectorum*). Invasive weeds are generally not an issue in most of this ecological site and tend to occupy limited areas in small patches near traditional watering facilities, along roads, and other areas that receive high soil disturbance. Cheatgrass and spotted knapweed pose the highest risk for invasion on the Shallow to Gravel site.

Plant Communities and Transitional Pathways

A state and transition model for this ecological site is depicted in the below diagram. Thorough descriptions of each state, transition, plant community, and pathway follow the model. This model is based on available experimental research, field data, field observations, and interpretations by experts. It is likely to change as knowledge increases.

The plant communities within the same ecological site will differ across the MLRA due to the naturally occurring variability in weather, soils, and aspect. The biological processes on this site are complex; therefore, representative values are presented in a land management context. The species lists are representative and are not botanical descriptions of all species occurring, or potentially occurring, on this site. They are intended to cover the core species and the known range of conditions and responses.

Both percent species composition by weight and percent canopy cover are referenced in this document. Most observers find it easier to visualize or estimate the percent canopy for woody species (trees and shrubs). Canopy cover drives the transitions between communities and states because of the influence of shade, the interception of rainfall, and the competition for available water. Species composition by dry weight remains an important descriptor of the herbaceous community and of the community as a whole. Woody species are included in the species composition for the site. Calculating the similarity index requires species composition by dry weight.

Although there is considerable qualitative experience supporting the pathways and transitions within the state and transition model (STM), no quantitative information exists that specifically identifies threshold parameters between grassland types and invaded types in this ecological site.

State and transition model

Ecosystem states

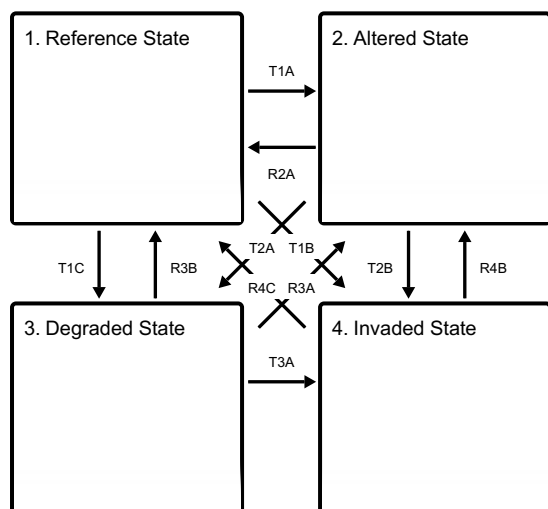

State 1 submodel, plant communities

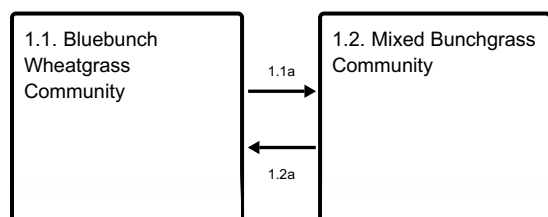

State 2 submodel, plant communities

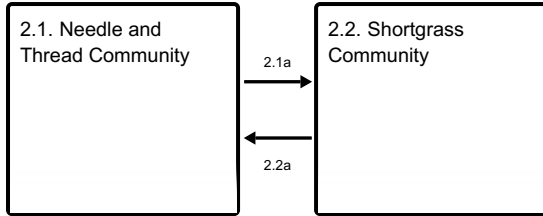

State 3 submodel, plant communities

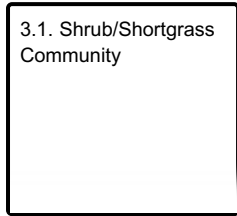

State 4 submodel, plant communities

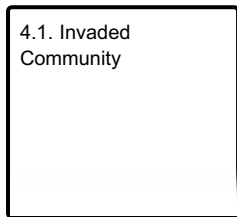

State 1 Reference State

The Reference State of this ecological site consists of two known potential plant communities 1.1 Bluebunch Community and 1.2 Mixed Bluebunch Community. These are described below but are generally characterized by a mid-statured, cool-season grass community with limited shrub production. Community 1.1 is dominated by bluebunch wheatgrass and is considered the reference, while Community 1.2 has a codominance of bluebunch and needle and thread with an increase in rabbitbrush and broom snakeweed. These communities may meld into each other due to the varying conditions that occur in southwest Montana, particularly during dry cycles where the needle and thread growth cycle takes better advantage of the limited moisture.

Community 1.1 Bluebunch Wheatgrass Community

In the Reference Plant Community, bluebunch wheatgrass (*Pseudoroegneria spicata*), green needlegrass (*Nassella viridula*), and needle and thread (*Hesperostipa comata*) are typically dominant. Indian ricegrass (*Achnatherum hymenoides*) and winterfat (*Krascheninnikovia lanata*) are subordinates in the community. Shrub species such as spineless horsebrush, big sagebrush, fringed sagewort, and broom snakeweed remain a minor part of the community. Sandberg bluegrass (*Poa secunda*) and dryland sedges are also common. This state occurs on this site in areas with proper livestock grazing or in areas with little or no grazing pressure. Bluebunch wheatgrass lacks resistance to grazing during the critical growing season (spring) and will decline in vigor and production if grazed in the critical growing season more than one year in three (Wilson et al. 1960). The Bunchgrass Wheatgrass Community is moderately resilient and will return to dynamic equilibrium following a relatively short period of stress (such as drought or short-term improper grazing), provided a return of favorable or normal growing conditions and properly managed grazing. As discussed in the Ecological Dynamics section, the natural fire regime restricted shrubs to relatively small portions of Reference Plant Community 1.1. Shrub species present may include Wyoming big sagebrush, spineless horsebrush, winterfat, tarragon (*Artemisia dracunculus*), and fringed sagewort. Infrequent fire probably maintained big sagebrush communities as open, seral stands of productive herbaceous species with patches of big sagebrush.

Dominant plant species

- Wyoming big sagebrush (*Artemisia tridentata ssp. wyomingensis*), shrub
- yellow rabbitbrush (*Chrysothamnus viscidiflorus*), shrub

- slender buckwheat (*Eriogonum microthecum*), shrub
- bluebunch wheatgrass (*Pseudoroegneria spicata*), grass
- needle and thread (*Hesperostipa comata*), grass
- Indian ricegrass (*Achnatherum hymenoides*), grass
- spiny phlox (*Phlox hoodii*), other herbaceous
- American vetch (*Vicia americana*), other herbaceous
- dotted blazing star (*Liatris punctata*), other herbaceous

Table 6. Annual production by plant type

Plant Type	Low (Kg/Hectare)	Representative Value (Kg/Hectare)	High (Kg/Hectare)
Grass/Grasslike	493	762	942
Forb	62	95	118
Shrub/Vine	62	95	118
Total	617	952	1178

Table 7. Ground cover

Tree foliar cover	0%
Shrub/vine/liana foliar cover	2-5%
Grass/grasslike foliar cover	10-18%
Forb foliar cover	1-3%
Non-vascular plants	0-1%
Biological crusts	0-1%
Litter	20-40%
Surface fragments >0.25" and <=3"	0-15%
Surface fragments >3"	0-5%
Bedrock	0%
Water	0%
Bare ground	5-15%

Table 8. Soil surface cover

Tree basal cover	0%
Shrub/vine/liana basal cover	5-15%
Grass/grasslike basal cover	35-55%
Forb basal cover	3-10%
Non-vascular plants	0-1%
Biological crusts	0-1%
Litter	20-40%
Surface fragments >0.25" and <=3"	0-15%
Surface fragments >3"	0-5%
Bedrock	0%
Water	0%
Bare ground	5-15%

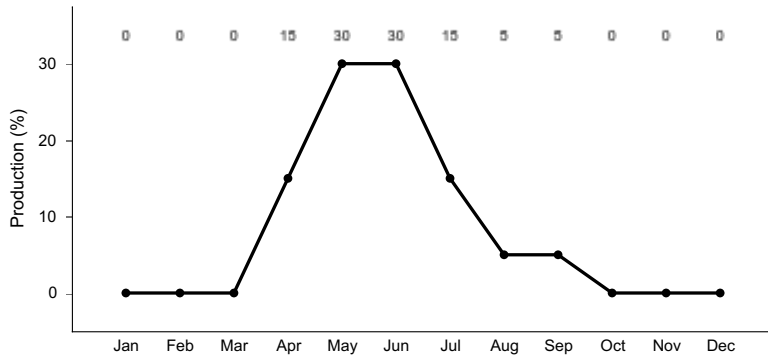

Figure 8. Plant community growth curve (percent production by month). MT44B032, Dry Uplands. Cool season grass dominated system. Most dry, upland sites located within MLRA 44B LRU A are characterized by early season growth which is mostly complete by Mid-July. Limited fall "green-up" if conditions allow..

Community 1.2 Mixed Bunchgrass Community

With proper grazing management over time, the Mixed Bunchgrass Community (1.2) can come close to the diversity and complexity of the Bluebunch Wheatgrass Community (1.1). Without active management, the site is not likely to return to the Bluebunch Wheatgrass Community. Western wheatgrass and needle and thread tolerate grazing pressure better than bluebunch wheatgrass. Bluebunch wheatgrass has a growing point several inches above the ground, making it vulnerable to continued close grazing (Smoliack et al., 2006), whereas western wheatgrass and needle and thread growing points are closer to the plant base. These plants increase in composition when less palatable and less grazing-tolerant plants decrease due to improper grazing management. Needle and thread, western wheatgrass, and bluebunch wheatgrass share dominance in the Mixed Bunchgrass Community (1.2). Other grass species that are more tolerant of grazing and are likely to increase in number compared to the Reference Plant Community include Sandberg bluegrass (*Poa secunda*), prairie Junegrass, thickspike wheatgrass (*Elymus lanceolatus*), and blue grama (*Bouteloua gracilis*). Western yarrow, Hoods phlox (*Phlox hoodii*), scarlet globemallow (*Sphaeralcea coccinea*), hairy goldenaster (*Heterotheca villosa*), and pussytoes (*Antennaria* spp.) are examples of increaser forbs. Fringed sagewort (*Artemisia frigida*) is a shrub that also increases under prolonged drought or heavy grazing and can respond to precipitation that falls in July and August. Heavy, continuous grazing will reduce plant cover, litter, and mulch. The timing of grazing is important on this site because of the moisture limitations beyond June, especially on the drier sites. Bare ground will increase, exposing the soil to erosion. Litter and mulch will be reduced as plant cover declines. As long as the production of Bluebunch wheatgrass remains a significant portion of the total biomass production, the site can return to the Bluebunch Wheatgrass Community (Pathway 1.2A) under proper grazing management and favorable growing conditions. Needle and thread and western wheatgrass will continue to increase until they make up 65 percent or more of the species composition. Once bluebunch wheatgrass has been reduced to less than 10 percent of its original composition, it may be difficult for the site to recover to the level of the Reference Plant Community (1.1). The risk of soil erosion increases when canopy cover decreases below 50 percent. As soil conditions degrade, there will be a loss of organic matter, reduced litter, and reduced soil fertility. Degraded soil conditions increase the difficulty of reestablishing bluebunch wheatgrass and returning to the Reference Community (1.1). The Mixed Bunchgrass Community (1.2) is the at-risk plant community for this ecological site. When overgrazing continues, increaser species such as needle-and-thread and native forb species will become more dominant, and this triggers the change to the Altered State (2) or the Degraded State (3). Until the Mixed Bunchgrass Community (1.2) crosses the threshold into the Needle and Thread Community (2.1) or the Invaded Community (4.1), this community can be managed toward the Bluebunch Wheatgrass Community (1.1) using prescribed grazing and strategic weed control (if present). It may take several years to achieve this recovery, depending on growing conditions, the vigor of remnant bluebunch wheatgrass plants, and the aggressiveness of the weed treatments.

Pathway 1.1a Community 1.1 to 1.2

Bluebunch wheatgrass loses vigor with improper grazing or extended drought. When vigor declines enough for plants to die or become smaller, species with higher grazing tolerance increase in vigor and production as they access the resources previously used by bluebunch wheatgrass. The decrease in species composition by weight of

bluebunch wheatgrass to less than 50 percent indicates that the plant community has shifted to the Mixed Bunchgrass Community (1.2). The driver for community shift 1.1A is improper grazing management or prolonged drought. This shift is triggered by the loss of vigor of bluebunch wheatgrass, soil erosion, or prolonged drought coupled with improper grazing. Blaisdell (1958) stated that drought and warmer-than-normal temperatures are known to advance plant phenology by as much as one month. During drought years, plants may be especially sensitive or reach a critical stage of development earlier than expected. Because needle and thread usually blooms in June and bluebunch wheatgrass blooms in July, this should be considered when planning grazing management.

Pathway 1.2a

Community 1.2 to 1.1

The Mixed Bunchgrass Community (1.2) will return to the Bluebunch Wheatgrass Community (1.1) with proper grazing management and appropriate grazing intensity. Favorable moisture conditions will facilitate or accelerate this transition. It may take several years of favorable conditions for the community to transition back to a bluebunch dominated state. The driver for this community shift (1.2A) is the increased vigor of bluebunch wheatgrass, to the point that it represents more than 50 percent of species composition. The trigger for this shift is the change in grazing management favoring bluebunch wheatgrass. These triggers are generally conservative grazing management styles such as deferred or rest rotations utilizing moderate grazing (less than 50 percent use) combined with favorable growing conditions such as cool, wet springs. These systems tend to promote increases in soil organic matter, which promotes microfauna and can increase infiltration rates. Inversely, long periods of rest at a time when this state is considered stable may not result in an increase in bluebunch wheatgrass, and it has been suggested (Noy-Meir 1975) that these long periods of rest or underutilization may actually drive the system to a lower level of stability by creating large amounts of standing biomass, dead plant caudex centers, and gaps in the plant canopy.

State 2

Altered State

This state is characterized by having approximately 10 percent bluebunch wheatgrass by dry weight. It is represented by two communities that differ in the percent composition of needle and thread, production, and soil degradation. Production in this state can be similar to that in the Reference State (1). Some native plants tend to increase under prolonged drought and heavy grazing practices. A few of these species may include needle and thread, Sandberg bluegrass, scarlet globemallow, hairy goldenaster, and fringed sagewort. The Lewis and Clark journals (Moulton 1988) talk about the areas north of Dillon and Horse Prairie west of Clark Canyon Reservoir: "The soil of the plains is a light yellow clay, very meager and intermixed with a large proportion of gravel, producing nothing except the twisted or bearded grass, sedge, and prickly pears." Many of their journeys were hampered by needle and thread awns in their moccasins. This may suggest that there was extensive, repeated use prior to the Corps of Discovery expedition. Today, needle and thread dominates that area, suggesting that transitioning from the Altered State back to the Reference State may require multiple years of recovery, reaffirming the Domaar 1997 study.

Community 2.1

Needle and Thread Community

Long-term grazing mismanagement with continuous growing-season pressure will reduce the total productivity of the site and lead to an increase in bare ground. Once plant cover is reduced, the site is more susceptible to erosion and degradation of soil properties. Soil erosion or reduced soil health will result in reduced plant production. This soil erosion or loss of soil fertility indicates the transition to the Altered State (2) because it creates a threshold requiring energy input to return to the Reference State (1). Transition to the Needle and Thread Community (2.1) may be exacerbated by extended drought conditions. Bluebunch wheatgrass makes up less than 10 percent of the species composition by dry weight, and the remaining bluebunch wheatgrass plants tend to be scattered and low in vigor. Invasive species will become more common, increasing competition for bluebunch wheatgrass. This makes it difficult for bluebunch wheatgrass to quickly respond to a change in grazing management alone. Therefore, an input of energy is required for the community to return to the Reference State (1). Wind and water erosion may be eroding soil from the plant interspaces. Soil fertility is reduced, and soil surface erosion resistance has declined compared to the Reference State (1). This community crossed a threshold compared to the Mixed Bunchgrass Community (1.2) due to the erosion of soil, vegetation composition, loss of soil fertility, or degradation of soil

conditions. This results in a critical shift in the ecology of the site. The effects of soil erosion can alter the hydrology, soil chemistry, soil microorganisms, and soil structure to the point where intensive restoration is required to restore the site to another state or community. Changing grazing management alone cannot create sufficient improvement to restore the site within a reasonable time frame. Dormaar (1997) stated that with decreased grazing pressure, a needle and thread/blue grama plant community did not change species composition, but the content of the soil carbon increased. It will require a considerable input of energy to move the site back to the Reference State (1). This state has lost soil or vegetation attributes to the point that recovery to the Reference State (1) will require reclamation efforts, i.e., soil rebuilding, intensive mechanical treatments, and reseeding. The transition to this state could result from overgrazing, especially repeated early-season grazing coupled with extensive drought. If heavy grazing continues, plant cover, litter, and mulch will continue to decrease, and bare ground will increase, exposing the soil to accelerated erosion. Litter and mulch will move off-site as plant cover declines. The Needle and thread Community will then shift to a Shortgrass Community (2.2). Continued improper grazing will drive the community to a Degraded State (3). Introduction or expansion of invasive species will further drive the plant community into the Invaded State (4).

Community 2.2

Shortgrass Community

With continued mismanagement of grazing, especially coupled with prolonged drought, needle and thread will decrease in vigor, causing a shift to the more degraded shortgrass/needle and thread community. The bunchgrasses will decline in production as plants die or become smaller, and species with higher grazing tolerance (such as thickspike wheatgrass) will increase in vigor and production as they respond to resources previously used by the bunchgrasses. These less desirable, shorter-rooted species will become co-dominant with the taller bunchgrasses. Shrubs will become more competitive for limited moisture as bare ground and soil erosion increase.

Pathway 2.1a

Community 2.1 to 2.2

The driver for community shift 2.1A is continued improper grazing management. This shift is triggered by the continued loss of bunchgrass vigor, especially since needle and thread is the remaining mid-statured bunchgrass. The short-statured grasses will become more competitive and will become co-dominant with the bunch grasses. Shrubs will increase their canopy cover but generally stay below about 15 percent.

Pathway 2.2a

Community 2.2 to 2.1

If proper grazing management is implemented, needle and thread may regain its vigor and move towards the needle and thread community (2.1). This will give grasses an advantage over invading shrubs before too much competition takes place. The advantage to grasses comes from following a conservative grazing plan where utilization is reduced and rest or deferment is incorporated since the transition from Plant Community 2.1 to Plant Community 2.2 is likely caused by repeated heavy utilization. Van Poolen and Lacey (1979) found that forage production increased by an average of 35 percent on western ranges when converting heavy to moderate utilization (less than 50 percent). Shrub removal and favorable growing conditions can accelerate this process. If the site contains Wyoming big sagebrush (*Artemisia tridentata* spp. *wyomingensis*), low-intensity fire or mechanical treatment (Wambolt 1986) could reduce shrub competition and allow for increased vigor and the reestablishment of grass species.

State 3

Degraded State

The Degraded State is described by a single plant community consisting of nearly equal components of increaser grasses, shrubs, and forbs. Large patches of bare ground exist, with areas of erosional pedestalling and terracettes common. Dense clubmoss (*Selaginella densa*) exists between plant bases as a reaction to the increased bare ground.

Community 3.1

Shrub/Shortgrass Community

Soil loss continues or increases to the point that native perennial grasses make up less than 150 pounds of annual dry weight production. Grass and forb cover may be very sparse or clumped (canopy cover less than 30 percent). Weeds, annual species, cacti, or shrubs dominate the plant community. Mid-stature perennial bunchgrass species (e.g., needle and thread) may exist, but only in small patches. This is driven primarily by overgrazing however heavy traffic impact from humans or livestock may also transition prior states to this community. Plant production may be as low as 200 pounds per acre with high bare ground. In the most severe stages of degradation, there is a significant amount of bare ground, and large gaps occur between plants. Large patches of prickly pear cactus are common. Potential exists for soils to erode to the point that irreversible damage may occur. This is a critical shift in the ecology of the site. Soil erosion combined with lack of organic matter deposition due to sparse vegetation create changes to the hydrology, soil chemistry, soil microorganisms, and soil structure to the point where intensive restoration is required to restore the site to another state or community. Changing management (i.e., improving grazing management) cannot create sufficient change to restore the site within a reasonable time frame. This state is characterized by soil surface degradation and little plant soil surface cover. Shrub canopy cover is usually greater than 15 percent. In this plant community, big sagebrush is replaced with a dominant community of broom snakeweed, rabbitbrush, fringed sagewort, and plains pricklypear cactus. This state has lost soil or vegetation attributes to the point that recovery to the Bunchgrass Grassland State will require reclamation efforts, i.e. soil rebuilding, intensive mechanical treatments, and reseeding. This plant community may be in a terminal state that will not return to the reference state without significant inputs because of degraded soil conditions and loss of deep-rooted, native plant species. Key factors of approach to transition are decrease in grass canopy cover and production, increase of shrub canopy cover, increases in mean bare patch size, increases in soil crusting, decreases in cover of cryptobiotic crusts, decreases in soil aggregate stability, or evidence of erosion including water flow patterns and litter movement.

State 4 Invaded State

The Invaded State is identified as being in the exponential growth phase of invader abundance where control is a priority. Dominance (or relative dominance) of noxious or invasive species reduces species diversity, forage production, wildlife habitat, and site protection. A level of 20 percent invasive species composition by dry weight indicates that a substantial energy input will be required to create a shift to the grassland state (herbicide, mechanical treatment), even with a return to proper grazing management or favorable growing conditions. Prescriptive grazing can be used to manage invasive species. In some instances, carefully targeted grazing (sometimes in combination with other treatments) can reduce or maintain the species composition of invasive species. If invading plants exceed 25 percent of species composition by dry weight, the invasive nature of the weed outcompetes the present plant community and may be irreversibly present. Once the weed reaches its maximum population level for this site, effective control is unlikely without massive resource inputs. After invading species have established and spread, ecological processes at the site may change (Walker and Smith 1997).

Community 4.1 Invaded Community

Communities in this state may be structurally indistinguishable from the Reference State except that invasive or noxious species exceed 20 percent of species composition by dry weight. This state may also include a community similar to the Degraded State (3) except that invasive or noxious species exceed 20 percent of species composition by dry weight. Although there is no research to document the level of 20 percent, this is estimated to be the point in the invasion process following the lag phase based on the interpretation of Masters and Sheley (2001). For aggressive invasive species (i.e., spotted knapweed), a 20 percent threshold could be less than 10 percent. Early in the invasion process, there is a lag phase where the invasive plant populations remain small and localized for long periods before expanding exponentially (Hobbs and Humphries 1995). Production in the invaded community may vary greatly. A site dominated by Kentucky bluegrass or spotted knapweed, where soil fertility and chemistry remain near reference, may have production near that of the reference community. A site with degraded soils and an infestation of cheatgrass may produce only 10 to 20 percent of the reference community. The Invaded State (4) is reached when invasive species dominate the site, either in terms of species composition by weight or in terms of their impact on the community. As invasive species such as spotted knapweed, cheatgrass, and leafy spurge become established, they become very difficult to eradicate. Therefore, considerable effort should be put into preventing plant communities from crossing a threshold into the Invaded State (4) through early detection and proper management. Preventing new invasions is by far the most cost-effective control strategy and typically places

an emphasis on education. Control measures used on the noxious plant species impacting this ecological site include chemical, biological, and cultural control methods. The best success has been found with an integrated pest management (IPM) strategy that incorporates one or several of these options along with education and prevention efforts (DiTomaso 2000).

Transition T1A

State 1 to 2

The Reference State (1) transitions to the Altered State (2) if bluebunch wheatgrass, by dry weight, decreases to below 10 percent or if bare ground cover increases beyond 20 percent. The driver for this transition is the loss of taller bunchgrasses, which creates open areas in the plant canopy with bare soil. Soil erosion reduces soil fertility, which drives transitions to the Altered State. There are several other key factors signaling the approach of transition T1A: increases in soil physical crusting, decreases in cover of cryptogamic crusts, decreases in soil surface aggregate stability, and/or evidence of erosion including water flow patterns, development of plant pedestals, and litter movement. The trigger for this transition is improper grazing management and/or long-term drought, leading to a decrease in bluebunch wheatgrass composition to less than 10 percent and a reduction in total plant canopy cover.

Transition T1C

State 1 to 3

The Reference State (1) transitions to the Degraded State (3) when bluebunch wheatgrass is removed from the plant community and needle and thread is subdominant to short-statured bunchgrasses such as Sandberg bluegrass. This transition differs from T1A in that it is usually quick and associated with disturbances like repeated overgrazing or heavy human traffic. This rapid transition is generally realized where livestock are confined to small pastures for long periods of time, such as horse pastures and calving lots. The driver for this transition is the loss of taller bunchgrasses, which creates openings in the canopy and exposes bare soil. Soil erosion reduces soil health, causing transitions to a degraded state. There are several other key factors signaling the approach of transition T1C: increases in soil physical crusting, decreases in cover of cryptogamic crusts, decreases in soil surface aggregate stability, and/or evidence of erosion including water flow patterns, development of plant pedestals, and litter movement. The trigger for this transition is improper grazing management, long term drought, and/or heavy human disturbance.

Transition T1B

State 1 to 4

Healthy plant communities are most resistant to invasion. However, regardless of grazing management, without some form of active weed management (chemical, mechanical, or biological control) and prevention, the Reference State (1) can transition to the Invaded State (4) in the presence of aggressive invasive species such as spotted knapweed, leafy spurge, and cheatgrass. This will occur even if the reference community is thriving. The Central Rocky Mountain Valleys tend to resist invasion by cheatgrass; however, repeated heavy grazing or intense human activities can open the interspaces of the bunchgrass community and allow for encroachment. Long-term stress conditions for native species (e.g., overgrazing, drought, and fire) accelerate this transition. If populations of invasive species reach critical levels, the site transitions to the Invaded State. The trigger for this transition is the presence of aggressive invasive species. The species composition by dry weight of invasive species approaches 10 percent.

Restoration pathway R2A

State 2 to 1

The Altered State (2) has lost soil or vegetation attributes to the point that recovery to the Reference State (1) will require reclamation efforts such as soil rebuilding, intensive mechanical and cultural treatments, and/or revegetation. Low-intensity prescribed fires are used to reduce competitive increaser plants like needle and thread and Sandberg bluegrass. A low-intensity fire will also reduce Wyoming big sagebrush densities. Fire should be carefully planned or avoided in areas prone to annual grass infestation.

Transition T2A

State 2 to 3

As improper grazing management continues, the vigor of bunch grasses will decrease and the shorter grasses and shrubs will increase, contributing to the Degraded State (3). Prolonged drought will provide a competitive advantage to shrubs, allowing them to become co-dominant with grasses. The canopy cover of shrubs will increase above 15 percent. Key transition factors include: an increase in native shrub canopy cover; a reduction in bunchgrass production; a decrease in total plant canopy cover and production; increases in mean bare patch size; increases in soil crusting; decreases in the cover of cryptobiotic crusts; decreases in soil aggregate stability; and/or evidence of erosion, including water flow patterns and litter movement.

Transition T2B

State 2 to 4

Invasive species can occupy the Altered State (2) and drive it to the Invaded State (4). The Altered State is at risk if invasive seeds and/or other viable material are present. The driver for this transition is more than 10 percent of the dry weight of invasive species.

Restoration pathway R3B

State 3 to 1

The Degraded State (3) has lost soil or vegetation attributes to the point that recovery to the Reference State (1) will require reclamation efforts, such as soil rebuilding, intensive mechanical treatments, and/or revegetation. Studies suggest (Whitford et al. 1989) that a mulch with a high carbon-to-nitrogen ratio, such as wood chips or bark, in low moisture scenarios can be beneficial for slow mobilization of plant-available nitrogen. Biochar may also be added to the system to improve Soil Organic Carbon (SOC) which should improve Cation Exchange Capacity (CEC), microbial activity, and hydrologic conductivity (Stavi 2012). The drivers for the restoration pathway are the removal of increaser species, restoration of native bunchgrass species, persistent management of invasives and shrubs, and proper grazing management. Without continued control, invasive and shrub species are likely to return (probably rapidly) due to the presence of seeds and/or other viable material in the soil and management-related increases in soil disturbance.

Restoration pathway R3A

State 3 to 2

Since the bunchgrass plant community has been significantly reduced, restoration to the Altered State (2) is unlikely unless a seed source is available. However, if enough grass remains on the site, chemical and/or biological control, in conjunction with proper grazing management, can reduce the amount of shrubs and invasive species and restore the site to the Shortgrass Community (2.2). Low-intensity fire can be utilized to reduce Wyoming big sagebrush competition and allow the reestablishment of grass species. Caution must be used when considering fire as a management tool on sites with fire-tolerant shrubs such as rubber rabbitbrush, as these shrubs will sprout after a burn. Broom snakeweed and fringed sagewort may or may not re-sprout depending on conditions (USDA Forest Service, 2011).

Transition T3A

State 3 to 4

Invasive species can occupy the Degraded State (3) and drive it to the Invaded State (4). The Degraded State is at risk of this transition occurring if invasive seeds or viable material are present. The driver for this transition is the presence of critical population levels (more than 10 percent dry weight of invasive species). The trigger is the presence of seeds or viable material from invasive species. This state has sufficient bare ground that the transition could occur simply due to the presence or introduction of invasive seeds or viable material. This is particularly true of aggressive invasive species such as spotted knapweed. This transition could be assisted by overgrazing (failure to adjust stocking rate to declining forage production), a long-term lack of fire, or an extensive drought.

Restoration pathway R4C

State 4 to 1

Restoration of the Invaded State (4) to the Reference State (1) requires substantial energy input. The drivers for the

restoration pathway are the removal of invasive species, restoration of native bunchgrass species, persistent management of invasive species, and proper grazing management. Without continued control, invasive species are likely to return (probably rapidly) due to the presence of seeds and/or other viable material in the soil and management-related practices that increase soil disturbance. Sites that have transitioned from the Degraded State (3) to the Invaded State (4) may be severely lacking in soil and vegetative properties that will allow for restoration to the Reference State. Hydrologic function damage may be irreversible, especially with accelerated gully erosion.

Restoration pathway R4B State 4 to 2

If invasive species are removed before remnant populations of bunchgrass are drastically reduced, the Invaded State (4) can revert to its altered state. The driver for the reclamation pathway is weed management without reseeding or removal of conifers (mechanical, cultural, or chemical, depending on the phase of the community). Continued Integrated Pest Management (IPM) will be required as many of the invasive species that can occupy the Invaded State have extended dormant seed life.

Additional community tables

Table 9. Community 1.1 plant community composition

Group	Common Name	Symbol	Scientific Name	Annual Production (Kg/Hectare)	Foliar Cover (%)
Grass/Grasslike					
1	Mid-Statured Cool Season Bunchgrass			522–762	
	bluebunch wheatgrass	PSSP6	<i>Pseudoroegneria spicata</i>	308–616	35–50
	needle and thread	HECO26	<i>Hesperostipa comata</i>	62–196	15–20
	Indian ricegrass	ACHY	<i>Achnatherum hymenoides</i>	0–67	0–3
	green needlegrass	NAVI4	<i>Nassella viridula</i>	0–34	0–1
2	Increaser Grasses/Grasslikes			94–179	
	thickspike wheatgrass	ELLA3	<i>Elymus lanceolatus</i>	34–174	5–10
	western wheatgrass	PASM	<i>Pascopyrum smithii</i>	0–67	0–5
	prairie Junegrass	KOMA	<i>Koeleria macrantha</i>	8–62	2–5
	Sandberg bluegrass	POSE	<i>Poa secunda</i>	8–62	2–5
	plains reedgrass	CAMO	<i>Calamagrostis montanensis</i>	7–56	2–5
	needleleaf sedge	CADU6	<i>Carex duriuscula</i>	7–50	2–4
	blue grama	BOGR2	<i>Bouteloua gracilis</i>	7–34	2–3
	threadleaf sedge	CAFI	<i>Carex filifolia</i>	11–34	0–1
	sand dropseed	SPCR	<i>Sporobolus cryptandrus</i>	0–22	0–1
Forb					
3	Forbs			62–118	
	dotted blazing star	LIPU	<i>Liatris punctata</i>	7–56	1–3
	hairy false goldenaster	HEVI4	<i>Heterotheca villosa</i>	11–56	1–3
	American vetch	VIAM	<i>Vicia americana</i>	11–50	1–5
	spiny phlox	PHHO	<i>Phlox hoodii</i>	7–39	1–2
	fleabane	ERIGE2	<i>Erigeron</i>	0–34	1–2
	desertparsley	LOMAT	<i>Lomatium</i>	0–28	0–2
	scarlet globemallow	SPCO	<i>Sphaeralcea coccinea</i>	11–28	0–1
	rosy pussytoes	ANRO2	<i>Antennaria rosea</i>	0–11	0–1
	Drummond's milkvetch	ASDR3	<i>Astragalus drummondii</i>	0–11	0–1
	stemless mock	STAC	<i>Stenotus acaulis</i>	0–11	0–1

	goldenweed				
	locoweed	OXYTR	<i>Oxytropis</i>	0–11	0–1
	bastard toadflax	COUM	<i>Comandra umbellata</i>	0–11	0–1
Shrub/Vine					
4	Shrubs			62–118	
	Wyoming big sagebrush	ARTRW8	<i>Artemisia tridentata ssp. wyomingensis</i>	34–101	2–10
	winterfat	KRLA2	<i>Krascheninnikovia lanata</i>	17–45	1–3
	rubber rabbitbrush	ERNA10	<i>Ericameria nauseosa</i>	11–39	0–3
	little sagebrush	ARARA	<i>Artemisia arbuscula ssp. arbuscula</i>	0–39	0–3
	yellow rabbitbrush	CHVI8	<i>Chrysothamnus viscidiflorus</i>	11–39	0–3
	broom snakeweed	GUSA2	<i>Gutierrezia sarothrae</i>	0–22	0–1
	slender buckwheat	ERMI4	<i>Eriogonum microthecum</i>	0–11	0–1
	prairie sagewort	ARFR4	<i>Artemisia frigida</i>	0–11	0–1
	plains pricklypear	OPPO	<i>Opuntia polyacantha</i>	0–6	0–1

Animal community

The Shallow to Gravel ecological site of the Central Rocky Mountains Valleys, LRU 01 Subset A, provides a variety of wildlife habitat for an array of species. Prior to the settlement of this area, large herds of antelope, elk, and bison roamed. Though the bison have been replaced, mostly with domesticated livestock, elk and antelope still frequently utilize this largely intact landscape for winter habitat in areas adjacent to forests.

The relatively high grass component of the Reference Community provides excellent nesting cover for multiple neotropical migratory birds that select for open grasslands, such as the long-billed curlew and McCown's longspur.

Greater sage grouse may be present on sites with suitable habitat, typically requiring a minimum of 15 percent sagebrush canopy cover (Wallestad 1975). The Bunchgrass Community (1.1) is likely to have a minimal sage grouse presence given its low sagebrush canopy cover and forb components. Other communities on the site with sufficient sagebrush cover may harbor sage grouse populations, specifically Community 2.1 (needle and thread/sagebrush) where big sagebrush populations increase under a reduced fire regime. Additionally, as the sagebrush canopy cover increases due to the altered state, pygmy rabbit, Brewer's sparrow, and Mule Deer use may increase.

Managed livestock grazing is suitable on this site due to the potential to produce an abundance of high-quality forage. To maintain the productivity of the Shallow to Gravel site, grazing on adjacent sites with lower production must be carefully managed to ensure that utilization on this site is not excessive. Management objectives should include maintenance or improvement of the native plant community. Careful management of the timing and duration of grazing is important. Shorter grazing periods and adequate deferment during the growing season are recommended for plant maintenance, health, and recovery. According to McLean et al., early-season defoliation of bluebunch wheatgrass can result in high mortality and reduced vigor in plants. They also suggest, based on prior studies, that the opportunity for regrowth is necessary before dormancy to reduce injury bluebunch.

Since needle and thread normally matures earlier than bluebunch wheatgrass and produces a sharp awn, this species is usually avoided after seed set. Changing the grazing season will allow needle and thread to be used more efficiently.

Continual non-prescribed grazing of this site will be injurious, will alter the plant composition and production over time, and will result in the transition to the Altered State. The transition to other states will depend on the duration of poorly managed grazing as well as other circumstances such as weather conditions and fire frequency.

The Altered State can degrade further to the Degraded State or the Invaded State. Management should focus on grazing management strategies that will prevent further degradation, such as seasonal grazing deferment or winter

grazing where feasible. Communities within this state are still stable and healthy under proper management. Forage quantity and/or quality may be substantially decreased from the Reference State.

Grazing is possible in the Invaded State. Invasive species are generally less palatable than native grasses. Forage production is typically greatly reduced in this state. Due to the aggressive nature of invasive species, sites in the Invaded State face an increased risk of further degradation to the Invaded State. Grazing has to be carefully managed to avoid further soil loss and degradation and possible livestock health issues.

Prescriptive grazing can be used to manage invasive species. In some instances, carefully targeted grazing (sometimes in combination with other treatments) can reduce or maintain the species composition of invasive species. In the Degraded Shortgrass State, grazing may be possible but is generally not economically and/or environmentally sustainable.

Hydrological functions

The hydrologic cycle functions best in the Bunchgrass State (1) with good infiltration and deep percolation of rainfall; however, the cycle degrades as the vegetation community declines. Rapid rainfall infiltration, high soil organic matter, good soil structure, and good porosity accompany high bunchgrass canopy cover (Thurow et al. 1986). High ground cover reduces raindrop impact on the soil surface, which keeps erosion and sedimentation transport low. Water leaving the site will have a minimal sediment load, which allows for high water quality in associated streams. High rates of infiltration will allow water to move below the rooting zone during periods of heavy rainfall. The Bluebunch Wheatgrass Community (1.1) should have no rills or gullies present, and drainage ways should be vegetated and stable. Water flow patterns, if present, will be barely observable. Plant pedestals are essentially nonexistent. Plant litter remains in place and is not moved by wind or water.

In the Shortgrass Community (2.2), Degraded Shortgrass State (3), and the Invaded State (4), canopy and ground cover are greatly reduced compared to the Bunchgrass State (1), which impedes the hydrologic cycle. Infiltration will decrease and runoff will increase due to reduced ground cover, the presence of shallow-rooted species, rainfall splash, soil capping, reduced organic matter, and poor structure. Sparse ground cover and decreased infiltration can combine to increase the frequency and severity of flooding within a watershed. Soil erosion is accelerated, the quality of surface runoff is poor, and sedimentation increases (McCalla et al., 1984).

Recreational uses

This site provides some limited recreational opportunities for hiking, horseback riding, big game and upland bird hunting. The forbs have flowers that appeal to photographers. This site provides valuable open space.

Inventory data references

Information presented was derived from the site's Range Site Description (Shallow to Gravel 9 –14" P.Z., Northern Rocky Mountain Valleys, South, East of Continental Divide), NRCS clipping data, literature, field observations, and personal contacts with range-trained personnel (i.e., used professional opinion of agency specialists, observations of land managers, and outside scientists).

References

. Fire Effects Information System. <http://www.fs.fed.us/database/feis/>.

. 2021 (Date accessed). USDA PLANTS Database. <http://plants.usda.gov>.

Arno, S.F. and G.E. Gruell. 1982. Fire History at the Forest-Grassland Ecotone in Southwestern Montana. *Journal of Range Management* 36:332–336.

Arno, S.F. and A.E. Wilson. 1986. Dating Past fires in Curleaf Mountain-Mahogany communities. *Journal of Range Management* 39:241–243.

Barrett, H. 2007. Western Juniper Management: A Field Guide.

Bestelmeyer, B., J.R. Brown, J.E. Herrick, D.A. Trujillo, and K.M. Havstad. 2004. Land Management in the American Southwest: a state-and-transition approach to ecosystem complexity. *Environmental Management* 34:38–51.

Bestelmeyer, B. and J. Brown. 2005. State-and-Transition Models 101: A Fresh look at vegetation change.

Blaisdell, J.P. 1958. Seasonal development and yield of native plants on the Upper Snake River Plains and their relation to certain climate factors.

Blaisdell, J.P. and R.C. Holmgren. 1984. Managing Intermountain Rangelands--Salt-Desert Shrub Ranges. General Tech Report INT-163. USDA Forest Service, Intermountain Forest and Range Experiment Station, Ogden, UT. 52.

Bunting, S.C., B.M. Kilgore, and C.L. Bushey. 1987. Guidelines for Prescribe burning sagebrush-grass rangelands in the Northern Great Basin. General Technical Report INT-231. USDA Forest Service Intermountain Research Station, Ogden, UT. 33.

Colberg, T.J. and J.T. Romo. 2003. Clubmoss effects on plant water status and standing crop. *Journal of Range Management* 56:489–495.

Daubenmire, R. 1970. Steppe vegetation of Washington.

DiTomaso, J.M. 2000. Invasive weeds in Rangelands: Species, Impacts, and Management. *Weed Science* 48:255–265.

Dormaar, J.F., B.W. Adams, and W.D. Willms. 1997. Impacts of rotational grazing on mixed prairie soils and vegetation. *Journal of Range Management* 50:647–651.

Hobbs, J.R. and S.E. Humphries. 1995. An integrated approach to the ecology and management of plant invasions. *Conservation Biology* 9:761–770.

Kuchler, A.W. 1964. Potential natural vegetation of the conterminous United States.

Lacey, J.R., C.B. Marlow, and J.R. Lane. 1989. Influence of Spotted knapweed (*Centaurea maculosa*) on surface runoff and sediment yield.. *Weed Technology* 3:627–630.

Lesica, P. and S.V. Cooper. 1997. Presettlement vegetation of Southern Beaverhead County, MT.

Manske, L.L. 1980. Habitat, phenology, and growth of selected sandhills range plants.

Masters, R. and R. Sheley. 2001. Principles and practices for managing rangeland invasive plants. *Journal of Range Management* 38:21–26.

- McCalla, G.R., W.H. Blackburn, and L.B. Merrill. 1984. Effects of Livestock Grazing on Infiltration Rates of the Edwards Plateau of Texas. *Journal of Range Management* 37:265–269.
- McLean, A. and S. Wikeem. 1985. Influence of season and intensity of defoliation on bluebunch wheatgrass survival and vigor in southern British Columbia. *Journal of Range Management* 38:21–26.
- Miller, R.F., T.J. Svejcar, and J.A. Rose. 2000. Impacts of western juniper on plant community composition and structure. *Journal of Range Management* 53:574–585.
- Moulton, G.E. and T.W. Dunlay. 1988. *The Journals of the Lewis and Clark Expedition*. Pages in University of Nebraska Press.
- Mueggler, W.F. and W.L. Stewart. 1980. *Grassland and Shrubland Habitat Types of Western Montana*.
- Pelant, M., P. Shaver, D.A. Pyke, and J.E. Herrick. 2005. *Interpreting Indicators of Rangeland Health*.
- Pellant, M. and L. Reichert. 1984. Management and Rehabilitation of a burned winterfat community in Southwestern Idaho. Proceedings--Symposium on the biology of Atriplex and related Chenopods. 1983 May 2-6; Provo UT General Technical Report INT-172.. USDA Forest Service Intermountain Forest and Range Experiment Station. 281–285.
- Pitt, M.D. and B.M. Wikeem. 1990. Phenological patterns and adaptations in an Artemisia/Agropyron plant community. *Journal of Range Management* 43:350–357.
- Pokorny, M.L., R. Sheley, C.A. Zabinski, R. Engel, T.J. Svejcar, and J.J. Borkowski. 2005. Plant Functional Group Diversity as a Mechanism for Invasion Resistance.
- Ross, R.L., E.P. Murray, and J.G. Haigh. July 1973. *Soil and Vegetation of Near-pristine sites in Montana*.
- Schoeneberger, P.J. and D.A. Wysocki. 2017. *Geomorphic Description System, Version 5.0.*
- Smoliak, S., R.L. Ditterlin, J.D. Scheetz, L.K. Holzworth, J.R. Sims, L.E. Wiesner, D.E. Baldrige, and G.L. Tibke. 2006. *Montana Interagency Plant Materials Handbook*.
- Stavi, I. 2012. The potential use of biochar in reclaiming degraded rangelands. *Journal of Environmental Planning and Management* 55:1–9.
- Stringham, T.K., W.C. Kreuger, and P.L. Shaver. 2003. State and Transition Modeling: an ecological process approach. *Journal of Range Management* 56:106–113.
- Stringham, T.K. and W.C. Krueger. 2001. *States, Transitions, and Thresholds: Further refinement fro rangeland applications*.
- Sturm, J.J. 1954. *A study of a relict area in Northern Montana*. University of Wyoming, Laramie 37.

Thurrow, T.L., Blackburn W. H., and L.B. Merrill. 1986. Impacts of Livestock Grazing Systems on Watershed. Page in Rangelands: A Resource Under Siege: Proceedings of the Second International Rangeland Congress.

Various NRCS Staff. 2013. National Range and Pasture Handbook.

Walker, L.R. and S.D. Smith. 1997. Impacts of invasive plants on community and ecosystem properties. Pages 69–86 in Assessment and management of plant invasions. Springer, New York, NY.

Wambolt, C. and G. Payne. 1986. An 18-Year Comparison of Control Methods for Wyoming Big Sagebrush in Southwestern Montana. Journal of Range Management 39:314–319.

West, N.E. 1994. Effects of Fire on Salt-Desert shrub rangelands. Proceedings--Ecology and Management of Annual Rangelands: 1992 May 18-22. Boise ID General Technical Report INT-GTR-313.. USDA Forest Service Intermountain Research Station. 71–74.

Whitford, W.G., E.F. Aldon, D.W. Freckman, Y. Steinberger, and L.W. Parker. 1989. Effects of Organic Amendments on Soil Biota on a Degraded Rangeland. Journal of Range Management 41:56–60.

Wilson, A.M., G.A. Harris, and D.H. Gates. 1966. Cumulative Effects of Clipping on Yield of Bluebunch wheatgrass. Journal of Range Management 19:90–91.

Approval

Kirt Walstad, 9/08/2023

Rangeland health reference sheet

Interpreting Indicators of Rangeland Health is a qualitative assessment protocol used to determine ecosystem condition based on benchmark characteristics described in the Reference Sheet. A suite of 17 (or more) indicators are typically considered in an assessment. The ecological site(s) representative of an assessment location must be known prior to applying the protocol and must be verified based on soils and climate. Current plant community cannot be used to identify the ecological site.

Author(s)/participant(s)	Grant Petersen
Contact for lead author	grant.petersen@usda.gov
Date	05/30/2019
Approved by	Kirt Walstad
Approval date	
Composition (Indicators 10 and 12) based on	Annual Production

Indicators

1. **Number and extent of rills:** This site is primarily on gentle slopes. Rills will not be present in the Reference State.

2. **Presence of water flow patterns:** Active water flow patterns will not be present in the Reference State.

3. **Number and height of erosional pedestals or terracettes:** None Present

4. **Bare ground from Ecological Site Description or other studies (rock, litter, lichen, moss, plant canopy are not bare ground):** Bare ground is between 20-25 percent.

5. **Number of gullies and erosion associated with gullies:** None Present

6. **Extent of wind scoured, blowouts and/or depositional areas:** This site has sufficient canopy cover to resist wind erosion. No wind scours, blowouts, or depositional areas will be present in the Reference State.

7. **Amount of litter movement (describe size and distance expected to travel):** Movement of fine herbaceous litter may occur within less than a foot from where it originated.

8. **Soil surface (top few mm) resistance to erosion (stability values are averages - most sites will show a range of values):** Due to the coarse nature of the soil associated with this ecological site stability ratings will be low. Interspaces have ratings of 3-5 and under canopy will have values between 4-5.

9. **Soil surface structure and SOM content (include type of structure and A-horizon color and thickness):** Soil Structure at the surface is typically strong to medium fine granular. The A horizon should be 3-6 inches thick with color, when wet, typically ranging in Value of 5 or less and Chroma of 3 or less. Local geology may affect color in which it is important to reference the Official Series Description (OSD) for characteristic range.

10. **Effect of community phase composition (relative proportion of different functional groups) and spatial distribution on infiltration and runoff:** The Shallow to Gravel ecological site is well drained and has a high infiltration rate especially in the subsurface horizons. An even distribution of primarily mid stature grasses of site production, then cool season rhizomatous grasses along with a mix of shortgrass, forbs and shrubs.

11. **Presence and thickness of compaction layer (usually none; describe soil profile features which may be mistaken for compaction on this site):** Due to the coarse nature of the soil on this site, a compaction layer will not be present.

12. **Functional/Structural Groups (list in order of descending dominance by above-ground annual-production or live foliar cover using symbols: >>, >, = to indicate much greater than, greater than, and equal to):**

Dominant: Mid-statured, cool season, perennial bunchgrasses

Sub-dominant: rhizomatous grasses > short cool season bunchgrass = forbs = shrubs > warm season grasses

Other:

Additional:

-
13. **Amount of plant mortality and decadence (include which functional groups are expected to show mortality or decadence):** Mortality in herbaceous species is not evident. Species with bunch growth forms may have some natural mortality in centers is 3% or less. Shrubs, subshrubs mortality does not exceed 5% for any given species.
-
14. **Average percent litter cover (%) and depth (in):** Litter cover varies from approximately 20 to 40% with a median value of 30%; comprised of primarily herbaceous litter. Most litter is irregularly distributed on the soil surface and is not at a measurable depth. Most litter is irregularly distributed on the soil surface and is not at a measurable depth.
-
15. **Expected annual annual-production (this is TOTAL above-ground annual-production, not just forage annual-production):** Average annual production is 850. Low: 550 High 1050. Production varies based on effective precipitation and natural variability of soil properties for this ecological site.
-
16. **Potential invasive (including noxious) species (native and non-native). List species which BOTH characterize degraded states and have the potential to become a dominant or co-dominant species on the ecological site if their future establishment and growth is not actively controlled by management interventions. Species that become dominant for only one to several years (e.g., short-term response to drought or wildfire) are not invasive plants. Note that unlike other indicators, we are describing what is NOT expected in the reference state for the ecological site:** Potential invasive (including noxious) species (native and non-native). Invasive species on this ecological site include (but not limited to) dandelion, annual brome spp., spotted knapweed, yellow toadflax, leafy spurge, ventenata, etc.
- Native species such as Rocky Mountain Juniper, broom snakeweed, rabbitbrush spp., big sagebrush, blue grama, Sandberg's bluegrass, etc. when their populations are significant enough to affect ecological function, indicate site condition departure.
-
17. **Perennial plant reproductive capability:** In the reference condition, all plants are vigorous enough for reproduction either by seed or rhizomes in order to balance natural mortality with species recruitment. Density of plants indicates that plants reproduce at level sufficient to fill available resource.
-