

# Ecological site EX044B01B136

## Shallow Loamy (SwLo) LRU 01 Subset B

Last updated: 9/11/2023  
Accessed: 05/19/2024

---

### General information

**Provisional.** A provisional ecological site description has undergone quality control and quality assurance review. It contains a working state and transition model and enough information to identify the ecological site.

### MLRA notes

Major Land Resource Area (MLRA): 044B—Central Rocky Mountain Valleys

Major Land Resource Area (MLRA) 44B, Central Rocky Mountain Valleys, is nearly 3.7 million acres of southwest Montana. This MLRA borders two other MLRAs: 43B, Central Rocky Mountains and Foothills, and 46, Northern and Central Rocky Mountain Foothills.

The major watersheds of this MLRA are the Missouri and Yellowstone Rivers and their associated headwaters, such as the Beaverhead, Big Hole, Jefferson, Ruby, Madison, Gallatin, and Shields Rivers. Limited portions of the MLRA are west of the Continental Divide along the Clark Fork River. These waters allow for extensive irrigation for crop production in an area that is generally only compatible with rangeland and grazing. The Missouri River and its headwaters are behind several reservoirs used for irrigation water, hydroelectric power, and municipal water.

The primary land use of this MLRA is production agriculture (grazing, small grain production, and hay) with limited mining. Urban development is high, with large expanses of rangeland being converted to subdivisions for a rapidly growing population.

MLRA 44B consists of one Land Resource Unit (LRU) and seven climate-based LRU subsets. Annual precipitation ranges from a low of 9 inches to a high of near 24 inches. The driest areas tend to be in the valley bottoms of southwest Montana, in the rain shadow of the mountains. The wettest portions tend to be near the edges of the MLRA, where it borders MLRA 43B. Frost-free periods also vary greatly, with less than 30 days in the Big Hole Valley to approximately 110 days in the warm valleys along the Yellowstone and Missouri Rivers.

MLRA 44B's plant communities are highly variable but are dominated by a cool-season grass and shrub-steppe community on the rangeland and a mixed coniferous forest in the mountains. Warm-season grasses occupy an extremely limited extent and number of species in this MLRA. Most subspecies of big sagebrush are present, to some extent, across the MLRA.

### LRU notes

LRU 01 Subset B Central Concept:

- Moisture Regime: Ustic
- Temperature Regime: Frigid
- Dominant Cover: rangeland (mixed grassland and sagebrush steppe)
- Representative Value (RV) of range of Effective Precipitation: 15-19 inches
- Representative Value (RV) of range of Frost Free Days: 90-110 days

Climate Subset B exists in primarily in the Madison, Jefferson, Gallatin, Meagher, and Park Counties.

### Classification relationships

Mueggler and Stewart. 1980. Grassland and Shrubland habitat types of Western Montana

1. *Artemisia tridentata*/Agropyron spicatum h.t.
2. Agropyron spicatum/Agropyron smithii h.t.
3. *Artemisia tridentata*/Festuca scabrella h.t.
4. Agropyron spicatum/*Bouteloua gracilis* h.t.

EPA Ecoregions of Montana, Second Edition:

Level I: Northwestern Forested Mountains

Level II: Western Cordillera

Level III: Middle Rockies & Northern Great Plains

Level IV: Paradise Valley

Townsend Basin

Dry Intermontane Sagebrush Valleys

Shield-Smith Valleys

National Hierarchical Framework of Ecological Units:

Domain: Dry

Division: M330 – Temperate Steppe Division – Mountain Provinces

Province: M332 – Middle Rocky Mountain Steppe – Coniferous Forest – Alpine Meadow

Section: M332D – Belt Mountains Section

M332E – Beaverhead Mountains Section

Subsection: M332Ej – Southwest Montana Intermontane Basins and Valleys

M332Dk – Central Montana Broad Valleys

### Ecological site concept

- Site does not receive any additional water
- Soils are
  - o Generally not saline or saline-sodic
  - o Shallow with root restrictive lithic or paralithic layer 10 to 20 inches below soil surface.
  - o Typically less than 5 percent stone and boulder cover (15 percent maximum)
  - o Not Skeletal (less than 35 percent rock fragments) at 10-20 inch control section
  - o Not strongly or violently effervescent within surface mineral 4 inches
  - o Soil surface texture ranges from loam to clay loam in surface mineral 4 inches (clay percentage less than 32 percent).
- Parent material is alluvium and residuum

### Associated sites

EX044B01B138	<b>Shallow Droughty (SwDr) LRU 01 Subset B</b> EX044B01B138 The Shallow Droughty ecological site often occupies similar landscape position and has a similar plant community
EX044B01B040	<b>Loamy Steep (LoStp) LRU 01 Subset B</b> The Loamy Steep ecological site is often a neighboring site. Sites share similar plant communities

### Similar sites

EX044B01B138	<b>Shallow Droughty (SwDr) LRU 01 Subset B</b> EX044B01B138 The Shallow Droughty ecological site differs by being skeletal within 10 to 20 inch soil control section. These two sites share plant communities.
--------------	-------------------------------------------------------------------------------------------------------------------------------------------------------------------------------------------------------------------

Table 1. Dominant plant species

Tree	Not specified
Shrub	(1) <i>Artemisia tridentata</i> ssp. <i>wyomingensis</i> (2) <i>Tetradymia canescens</i>
Herbaceous	(1) <i>Festuca campestris</i> (2) <i>Pseudoroegneria spicata</i>

## Legacy ID

R044BB136MT

### Physiographic features

This ecological site can occur on nearly level to very steep hillslopes. It often occurs in a complex with other ecological sites. This site occurs from 2 to 45 percent; however, the core concept exists between 8 and 25 percent. Variations in plant community composition and production can result due to aspect, with south and west exposures tending to produce less. The amount of exposed rock outcrop tends to increase as slopes increase. Runoff and the potential for water erosion can be important features of this site.

**Table 2. Representative physiographic features**

Hillslope profile	(1) Summit (2) Shoulder
Landforms	(1) Intermontane basin > Scarp (2) Intermontane basin > Hillslope (3) Intermontane basin > Knoll
Runoff class	Medium to high
Elevation	1,463–1,981 m
Slope	8–25%

### Climatic features

The Central Rocky Mountain Valleys MLRA has a continental climate. 50 to 60 percent of the annual long-term average total precipitation falls between May and August. Most of the precipitation in the winter is snow on frozen ground. Average precipitation for LRU 01 Subset B is 17 inches, and the frost-free period averages 95 days. Precipitation is highest in May and June.

See Climatic Data Sheet for more details (Section II of the Field Office Technical Guide: [http://efotg.nrcs.usda.gov/efotg\\_locator.aspx?map=MT](http://efotg.nrcs.usda.gov/efotg_locator.aspx?map=MT)) or reference the following climatic web site: <http://www.wrcc.dri.edu/climsum.html>

**Table 3. Representative climatic features**

Frost-free period (characteristic range)	90-110 days
Freeze-free period (characteristic range)	96-123 days
Precipitation total (characteristic range)	356-483 mm
Frost-free period (actual range)	90-110 days
Freeze-free period (actual range)	82-136 days
Precipitation total (actual range)	356-483 mm
Frost-free period (average)	95 days
Freeze-free period (average)	108 days
Precipitation total (average)	432 mm

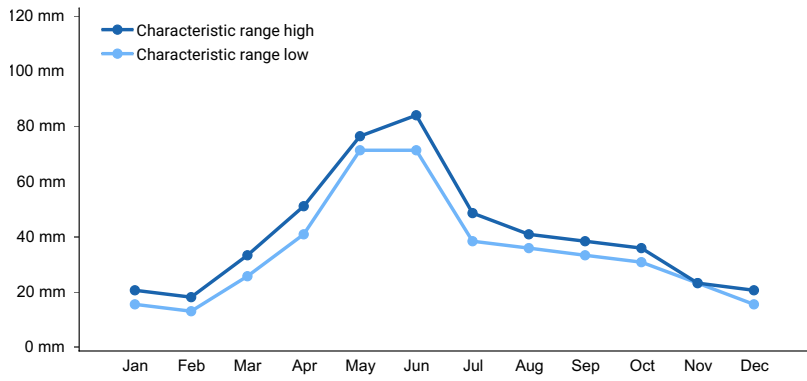

**Figure 1. Monthly precipitation range**

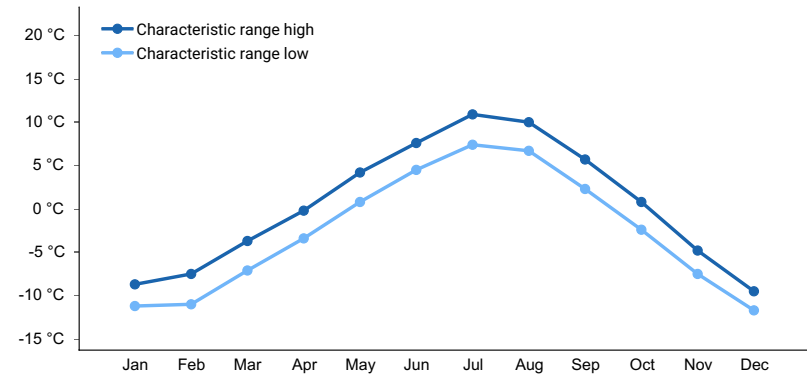

**Figure 2. Monthly minimum temperature range**

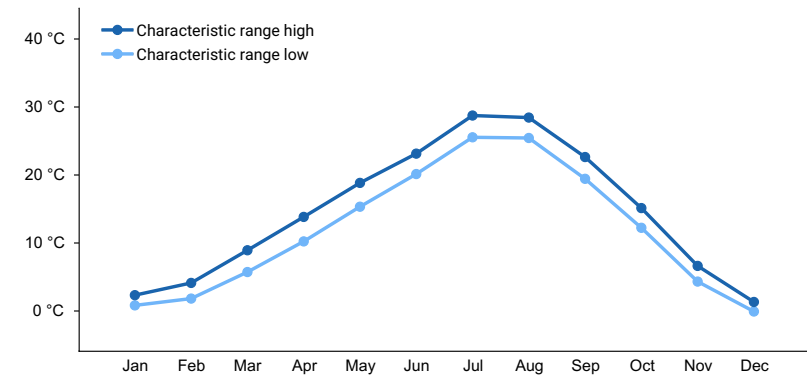

**Figure 3. Monthly maximum temperature range**

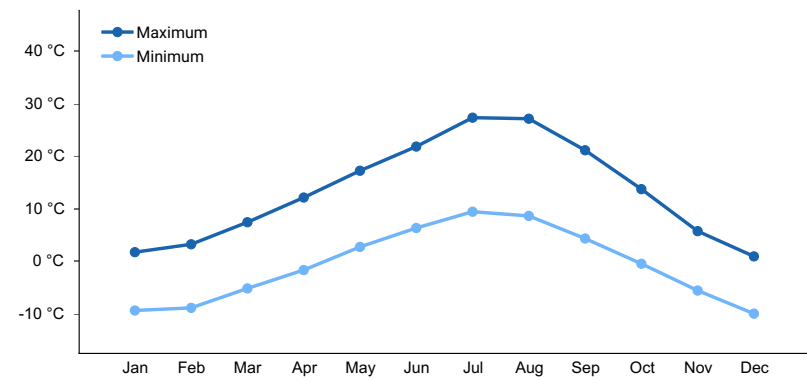

**Figure 4. Monthly average minimum and maximum temperature**

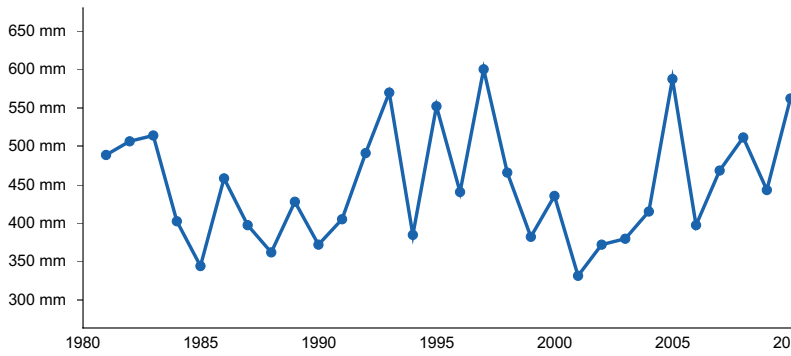

Figure 5. Annual precipitation pattern

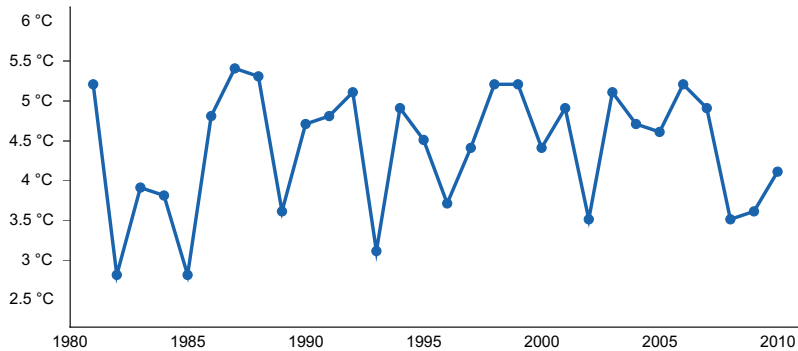

Figure 6. Annual average temperature pattern

### Climate stations used

- (1) WILLSALL 8 ENE [USC00249023], Wilsall, MT
- (2) BOZEMAN 6 W EXP FARM [USC00241047], Bozeman, MT
- (3) NORRIS MADISON PH [USC00246157], Ennis, MT
- (4) MILLEGAN 14 SE [USC00245712], White Sulphur Springs, MT
- (5) LENNEP 5 SW [USC00244954], White Sulphur Springs, MT

### Influencing water features

This ecological site is not associated with water features. The Shallow Loamy ecological site is an upland site that is well drained.

### Wetland description

Site is not associated with wetlands.

### Soil features

These soils are shallow to root-restricting bedrock. They have moderate-to-moderately rapid permeability, and they are well to somewhat excessively drained. These soils formed from residuum of mixed origins from non-calcareous geology. Typically, soil surface textures consist of loam, clay loam, and silt loam textures. Soils sometimes have a gravelly surface, but this will vary depending on their association with neighboring rocky sites. Common soil series in this ecological site include Cabba and Copnhaver. These soils may exist across multiple ecological sites due to natural variations in slope, texture, rock fragments, and pH.

Table 4. Representative soil features

Parent material	(1) Residuum—igneous, metamorphic and sedimentary rock
-----------------	--------------------------------------------------------

Surface texture	(1) Loam (2) Clay loam (3) Silt loam
Drainage class	Well drained to somewhat excessively drained
Permeability class	Moderate to moderately rapid
Depth to restrictive layer	25–51 cm
Soil depth	25–51 cm
Surface fragment cover <=3"	0–10%
Surface fragment cover >3"	0–3%
Available water capacity (0-50.8cm)	3.81–6.35 cm
Soil reaction (1:1 water) (0-50.8cm)	7.6–8.2
Subsurface fragment volume <=3" (25.4-50.8cm)	0–25%
Subsurface fragment volume >3" (25.4-50.8cm)	0–10%

## Ecological dynamics

The reference plant community is dominated by rough fescue (*Festuca campestris*), bluebunch wheatgrass (*Pseudoroegneria spicata*), and green needlegrass (*Nassella viridula*). Subdominant species may include western wheatgrass (*Pascoyprum smithii*), Idaho fescue (*Festuca idahoensis*), needle and thread (*Hesperostipa comata*), Wyoming big sage (*Artemisia tridentata* ssp. *wyomingensis*), sumac (*Rhus* spp.), winterfat (*Krascheninnikovia lanata*), and Indian ricegrass (*Achnatherum hymenoides*).

Natural fire was a major ecological driver of this entire ecological site. Fire tended to restrict tree and sagebrush growth to small patches and promote an herbaceous plant community. The natural fire return interval was highly variable, ranging up to 100 years; however, it was likely shorter than 35 years (Arno and Gruell 1983). With the historically recent, since 1910, suppression of fire sagebrush and trees have increased significantly.

Wyoming big sagebrush steppe communities historically had low fuel loadings and were characterized by 10- to 70-year interval fires that produced a mosaic of burned and unburned lands (Bunting et al., 1987). A shift to the dominance of shrubs may occur in response to improper grazing management, drought, or where big sagebrush occurs due to a lack of fire. Shrub encroachment by a variety of species, including, broom snakeweed (*Gutierrezia sarothrae*), fringed sagewort (*Artemisia frigida*), Wyoming big sagebrush, rubber rabbitbrush (*Ericameria nauseosa*), yellow rabbitbrush (*Chrysothamnus viscidiflorus*) and plains prickly pear cactus (*Opuntia polyacantha*) occur within this site as the mid-statured bunchgrasses decrease. Shrub dominance and grass loss can be associated with soil erosion and, ultimately, thinning of the native soil surface. Subsequent loss of soil could lead to a Degraded State. All states could also lead to the Invaded State when there is a lack of weed prevention and control measures.

Historical records indicate that, prior to the introduction of livestock (cattle and sheep) during the late 1800s, elk and bison grazed this ecological site. Due to the nomadic nature and herd structure of bison, areas that were grazed received periodic, high-intensity, short-duration grazing pressure. Livestock grazing has occurred on most of this ecological site in southwestern Montana for more than 150 years. The gold boom in the 1860s brought the first herds of livestock overland from Texas, and homesteaders began settling the area. During this time, cattle were the primary domestic grazers in the area. In the 1890s, Montana sheep production began to increase and dominated the livestock industry until the 1930s. Since the 1930s, cattle production has dominated the livestock industry in the region (Wyckoff and Hansen 2001).

Some of the major invasive species that can occur on this site include (but are not limited to) spotted knapweed (*Centaurea stoebe*), leafy spurge (*Euphorbia esula*), cheatgrass (*Bromus tectorum*), field brome (*Bromus arevensis*), yellow toadflax (*Linaria vulgaris*), and dandelion (*Taraxicum* spp.). Invasive weeds are beginning to

have a high impact on this ecological site, particularly cheatgrass invasion.

### Plant Communities and Transitions

A state and transition model (STM) for this ecological site is depicted below. Thorough descriptions of each state, transition, plant community, and pathway follow the model. This model is based on available experimental research, field data, field observations, and interpretations by experts. It is likely to change as knowledge increases.

The plant communities within the same ecological site will differ across the MLRA due to the naturally occurring variability in weather, soils, and aspect. The biological processes on this site are complex; therefore, representative values are presented in a land management context. The species lists are representative and are not botanical descriptions of all species occurring, or potentially occurring, on this site. They are intended to cover the core species and the known range of conditions and responses.

Although there is considerable qualitative experience supporting the pathways and transitions within the STM, no quantitative information exists that specifically identifies threshold parameters between grassland types and invaded types in this ecological site. For information on STMs, see the following citations: Bestelmeyer et al. (2003), Bestelmeyer et al. (2004), Bestelmeyer and Brown (2005), and Stringham et al. (2003).

### State and transition model

#### Ecosystem states

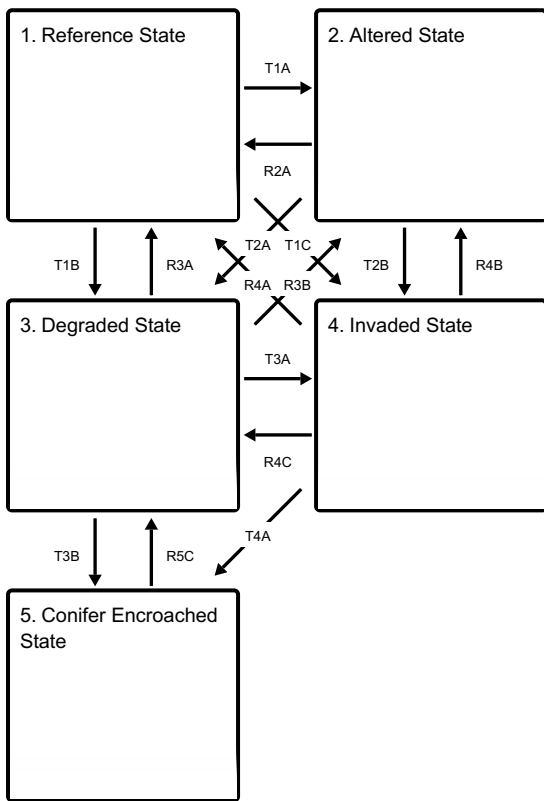

#### States 1, 5 and 2 (additional transitions)

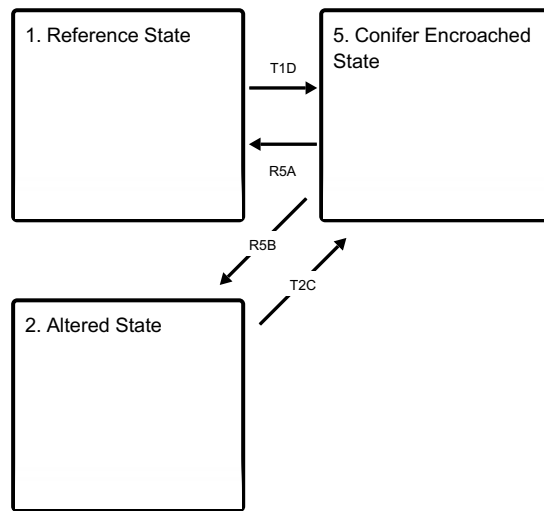

#### State 1 submodel, plant communities

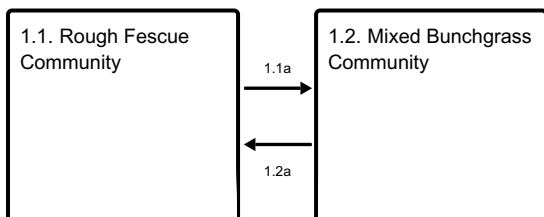

### State 2 submodel, plant communities

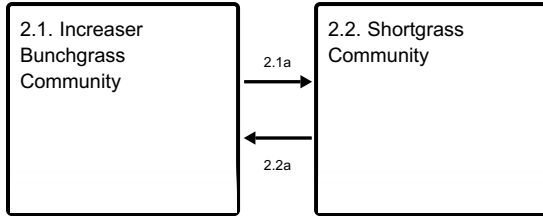

### State 3 submodel, plant communities

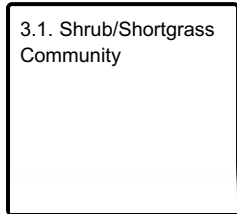

### State 4 submodel, plant communities

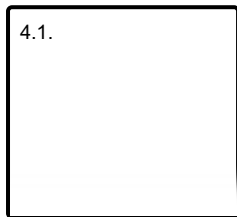

### State 5 submodel, plant communities

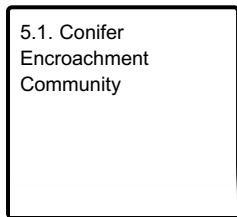

## State 1 Reference State

The Reference State of this ecological site consists of two (2) potential plant communities: the Rough Fescue Community and the Mixed Bluebunch Community. These are described below but are generally characterized by a mid-statured, cool-season grass community with limited shrub production. Community 1.1 is dominated by rough fescue and is considered the reference, while Community 1.2 has a codominance of rough fescue, bluebunch wheatgrass, green needlegrass, and western wheatgrass with a slight increase in shrubs. Infrequent fire maintained these communities as open, treeless, seral stands of productive herbaceous species with patches of big sagebrush and assorted shrubs. As a result, the Reference State's core concept does not include coniferous trees; however, up to two (2) trees may exist on the landscape when closely situated to forested areas.

### Community 1.1 Rough Fescue Community

In the Rough Fescue Community, rough fescue, bluebunch wheatgrass, and western wheatgrass are typically dominant. Green needlegrass, Idaho fescue, and winterfat are subordinates in the community. Shrub species (big sagebrush, fringed sagewort, and broom snakeweed) remain a minor part of the community. Spineless horsebrush (*Tetradymia canescens*) may occupy a small niche. Sandberg bluegrass (*Poa secunda*) and dryland sedges are also common. This state occurs on the Shallow Clay site in areas with proper livestock grazing or in areas with little or no grazing pressure. Careful grazing management of this ecological site is necessary to maintain this deep-rooted bunchgrass community. Rough fescue tends to respond negatively to summer grazing (King et al., 1998), regardless of grazing intensity (Dormaer and Willms, 1998). Bluebunch wheatgrass lacks resistance to grazing during the critical growing season (spring) and will decline in vigor and production if grazed in the critical growing season more than one year in three (Wilson et al., 1960). This evidence suggests that fall and dormant grazing in



this community are most appropriate. The Reference State is moderately resilient and will return to dynamic equilibrium following a relatively short period of stress (such as drought or short-term improper grazing), provided a return of favorable or normal growing conditions and properly managed grazing. As discussed in the Ecological Dynamics section, the natural fire regime restricted shrubs and coniferous trees to relatively small portions of Reference Plant Community 1.1. Shrub species present may include Wyoming big sagebrush, spineless horsebrush, winterfat, tarragon (*Artemisia drucunculus*), and fringed sagewort. Infrequent fire probably maintained big sagebrush communities as open, treeless, seral stands of productive herbaceous species with patches of big sagebrush.

### Dominant plant species

- big sagebrush (*Artemisia tridentata*), shrub
- Woods' rose (*Rosa woodsii*), shrub
- currant (*Ribes*), shrub
- rough fescue (*Festuca campestris*), grass
- bluebunch wheatgrass (*Pseudoroegneria spicata*), grass
- lupine (*Lupinus*), other herbaceous
- American vetch (*Vicia americana*), other herbaceous

**Table 5. Annual production by plant type**

Plant Type	Low (Kg/Hectare)	Representative Value (Kg/Hectare)	High (Kg/Hectare)
Grass/Grasslike	964	1222	1334
Shrub/Vine	45	101	179
Forb	45	95	168
Tree	–	–	11
<b>Total</b>	<b>1054</b>	<b>1418</b>	<b>1692</b>

**Table 6. Ground cover**

Tree foliar cover	0%
Shrub/vine/liana foliar cover	15-20%
Grass/grasslike foliar cover	45-75%
Forb foliar cover	5-7%
Non-vascular plants	0-3%
Biological crusts	0-3%
Litter	30-35%
Surface fragments >0.25" and <=3"	0-15%
Surface fragments >3"	0-3%
Bedrock	0%
Water	0%
Bare ground	5-15%

**Table 7. Soil surface cover**

Tree basal cover	0%
Shrub/vine/liana basal cover	3-5%
Grass/grasslike basal cover	10-15%
Forb basal cover	1-3%
Non-vascular plants	0-1%
Biological crusts	0-3%

Litter	30-35%
Surface fragments >0.25" and <=3"	0-15%
Surface fragments >3"	0-3%
Bedrock	0%
Water	0%
Bare ground	5-15%

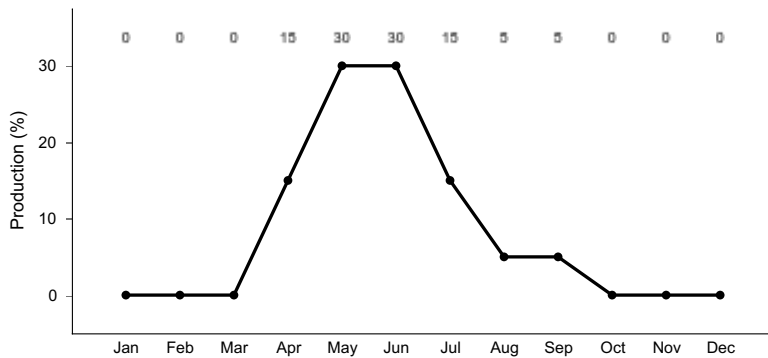

**Figure 8. Plant community growth curve (percent production by month). MT44B032, Dry Uplands. Cool season grass dominated system. Most dry, upland sites located within MLRA 44B LRU A are characterized by early season growth which is mostly complete by Mid-July. Limited fall "green-up" if conditions allow..**

## Community 1.2 Mixed Bunchgrass Community

With proper grazing management over time, the Mixed Bunchgrass Community (1.2) can come close to the diversity and complexity of the Rough Fescue Community (1.1). Without active management the site is not likely to return to near Reference Plant Community. Western wheatgrass and needle-and-thread tolerate grazing pressure better than bluebunch wheatgrass and rough fescue. The growing points the present tall, deeprooted bunchgrasses are several inches above the ground, making them very susceptible to continued close grazing (Smoliack, et al 2006) while western wheatgrass and needle-and-thread growing points tend to be near the plant base. These plants increase in composition when more palatable and less grazing tolerant plants decrease due to improper grazing management. Bluebunch wheatgrass, rough fescue, and western wheatgrass share dominance in the Mixed Bunchgrass Community (1.2). Other grass species, which are more tolerant to grazing and are likely to increase compared to the Rough Fescue Community, include Sandberg bluegrass (*Poa secunda*), prairie Junegrass, and blue grama (*Bouteloua gracilis*). Some increaser forbs species include western yarrow, Hoods phlox (*Phlox hoodii*), scarlet globemallow (*Sphaeralcea coccinea*), hairy goldenaster (*Heterotheca villosa*), and pussytoes (*Antennaria* spp.). Fringed sagewort (*Artemisia frigid*) is a shrub that also increases under prolonged drought or heavy grazing and can respond to precipitation that falls in July and August. Heavy continuous grazing will reduce plant cover, litter, and mulch. Timing of grazing is important on this site because of the moisture limitations beyond June, especially on the drier sites. Bare ground will increase and expose the soil to erosion. Litter and mulch will be reduced as plant cover declines. As long as the production of rough fescue and bluebunch wheatgrass remain a significant portion of the total biomass production, the site can return to the Rough Fescue Community (Pathway 1.2A) under proper grazing management and favorable growing conditions. Rough fescue will continue to decrease and bluebunch wheatgrass decreases slightly while needle-and-thread and Idaho fescue increase until grass species composition are nearly equal. Once rough fescue has been reduced to less than 10 percent by weight, it may be difficult for the site to recover to Rough Fescue Community (1.1). The risk of soil erosion increases when canopy cover decreases below 50 percent. As soil conditions degrade, there will be loss of organic matter, reduced litter, and reduced soil fertility. Degraded soil conditions increase the difficulty of reestablishing rough fescue and returning to the Rough Fescue Community (1.1). The Mixed Bunchgrass Community (1.2) is the At-Risk Plant Community for this ecological site. When overgrazing continues increaser species such as western wheatgrass, needle-and-thread and native forb species will become more dominant and this triggers the change to the Altered State (2) or the Degraded State (3). Until the Mixed Bunchgrass Community (1.2) crosses the threshold into another State, this community can be managed toward the Rough Fescue Community (1.1) using prescribed grazing and strategic weed control (if present). It may take several years to achieve this recovery, depending on growing

conditions, vigor of remnant rough fescue and bluebunch wheatgrass plants, and the aggressiveness of the weed treatments. Grazing management that benefits rough fescue tends to be a deferred or rest rotation (Fleenor July 2011)

### **Pathway 1.1a**

#### **Community 1.1 to 1.2**

Rough fescue and bluebunch wheatgrass lose vigor with improper grazing or extended drought. When vigor declines enough for plants to die or become smaller, species with higher grazing tolerance increase in vigor and production as they access the resources previously used by deep rooted bunchgrass. Decrease of species composition by weight of rough fescue to 50 percent of the grass community indicates that the plant community has shifted to the Mixed Bunchgrass Community (1.2). The driver for community shift 1.1A is improper grazing management or prolonged drought. This shift is triggered by the loss of vigor of rough fescue, soil erosion or prolonged drought coupled with improper grazing. Blaisdell (1958) stated that drought and warmer than normal temperatures are known to advance plant phenology by as much as one month. During drought years, plants may be especially sensitive or in a critical stage of development earlier than expected.

### **Pathway 1.2a**

#### **Community 1.2 to 1.1**

The Mixed Bunchgrass Community (1.2) will return to the Rough Fescue Community (1.1) with proper grazing management and appropriate grazing intensity. Favorable moisture conditions will facilitate or accelerate this transition. It may take several years of favorable conditions for the community to transition back to a rough fescue dominated state. The driver for this community shift (1.2A) is increased vigor of rough fescue to the point that it represents more than 50 percent by weight of the grass community. The trigger for this shift is the change in grazing management favoring rough fescue. In general, conservative grazing management styles such as deferred or rest rotations utilizing light to moderate grazing (less than 50 percent use) coupled with favorable growing conditions like cool, wet springs are these triggers. These systems tend to promote increases in soil organic matter which promotes microfauna and can increase infiltration rates. Inversely, long periods of rest at a time when this state is considered to be stable may not result in an increase in rough fescue and it has been suggested (Noy-Meir 1975) that these long periods of rest or underutilization may actually drive the system to a lower level of stability by creating large amounts of standing biomass, dead plant caudex centers, and gaps in the plant canopy.

## **State 2**

### **Altered State**

This state is characterized by having less than 10 percent rough fescue by dry weight. This state is represented by two communities. Community 2.1 is a community dominated by Idaho fescue and needle and thread with small components of deep-rooted bunchgrasses such as rough fescue, bluebunch wheatgrass, and green needlegrass. Community 2.2 has a significantly reduced deep-rooted bunchgrass population that is restricted to protected areas under shrubs. Production in this state tends to be significantly lower than in the Reference State (1). Some native plants tend to increase under prolonged drought and/or heavy grazing practices. A few of these species may include western wheatgrass, needle and thread, Sandberg bluegrass, scarlet globemallow, hairy goldenaster, and fringed sagewort.

### **Community 2.1**

#### **Increaser Bunchgrass Community**

Long-term grazing mismanagement with continuous growing-season pressure will reduce total productivity of the site and lead to an increase of bare ground. Once plant cover is reduced, the site is more susceptible to erosion and degradation of soil properties. Soil erosion or reduced soil health will result in reduced plant production. This soil erosion or loss of soil fertility indicates the transition to the Altered State (2), because it creates a threshold requiring input of energy to return to the Reference State (1). Transition to the Increaser Bunchgrass Community (2.1) may be exacerbated by extended drought conditions. Needle-and-thread dominates this community (2.1). Rough fescue makes up less than 10 percent of species composition by dry weight and the remaining deep rooted bunchgrass plants tend to be scattered and low in vigor. Increaser and invader species will be more common and create more competition for deep rooted bunchgrass. This makes it difficult for them to quickly respond to a change in grazing

management alone. Therefore, an input of energy is required for the community to return to the Reference State (1). Wind and water erosion may be eroding soil from the plant interspaces. Soil fertility is reduced and soil surface erosion resistance has declined compared to the Reference State (1). This community crossed a threshold compared to the Mixed Bunchgrass Community (1.2) due to the erosion of soil, vegetation composition, loss of soil fertility, or degradation of soil conditions. This results in a critical shift in the ecology of the site. The effects of soil erosion can alter the hydrology, soil chemistry, soil microorganisms, and soil structure to the point where intensive restoration is required to restore the site to another state or community. Changing grazing management alone cannot create sufficient improvement to restore the site within a reasonable time frame. Dormaar (1997) stated that with decreased grazing pressure a needle-and-thread/blue grama plant community did not change species composition but the content of the soil carbon increased. It will require a considerable input of energy to move the site back to the Reference State (1). This state has lost soil or vegetation attributes to the point that recovery to the Reference State (1) will require reclamation efforts, i.e., soil rebuilding, intensive mechanical treatments, and/or reseeding. The transition to this state could result from overgrazing, especially repeated early season grazing coupled with extensive drought. If heavy grazing continues, plant cover, litter, and mulch will continue to decrease and bare ground will increase exposing the soil to accelerated erosion. Litter and mulch will move off-site as plant cover declines. The Increaser Bunchgrass Community will then shift to a the Shortgrass Community (2.2) or the Degraded State (3) depending on the level of disturbance. Introduction or expansion of invasive species will further drive the plant community to the Invaded State (4).

## **Community 2.2**

### **Shortgrass Community**

With continued mismanagement of grazing, especially coupled with prolonged drought, needle-and-thread will decrease in vigor. The bunchgrasses will decline in production as plants die or become smaller, and species with higher grazing tolerance (such as western wheatgrass) increase in vigor and production as they respond to resources previously used by the bunchgrasses. These less desirable, shorter rooted species will become codominant in this community with midstatured bunchgrasses such as needle-and-thread and Idaho fescue. Shrubs will become more competitive for limited moisture as bare ground and soil erosion increase. Remaining deep rooted bunchgrasses such as rough fescue and bluebunch wheatgrass nearly absent in this community however remnant populations may exist under shrub canopy away from grazing pressure.

### **Pathway 2.1a**

#### **Community 2.1 to 2.2**

The driver for community shift 2.1a is continued improper grazing management. This shift is triggered by continued loss of bunchgrass vigor, especially the remaining trace amounts of rough fescue and bluebunch on the site. Shrubs will protect these less vigorous bunchgrasses. The mid and short statured grasses will become more competitive and become co-dominant with the bunchgrasses. Shrubs will increase in canopy cover but stay about 15 percent

### **Pathway 2.2a**

#### **Community 2.2 to 2.1**

If proper grazing management is implemented needle-and-thread may regain its vigor and move towards the Increase Bunchgrass Community (2.1). This will give grasses an advantage over invading shrubs before too much competition takes place. The advantage to grasses comes from following a conservative grazing plan where utilization is reduced and rest or deferment is incorporated since the transition from Plant Community 2.1 to Plant Community 2.2 is likely caused by repeated heavy utilization. Van Poolen and Lacey (1979) found that forage production increased by an average of 35 percent on western ranges when converting heavy to moderate utilization (less than 50 percent). Shrub removal and favorable growing conditions can accelerate this process. If the site contains Wyoming big sagebrush (*Artemisia tridentata* spp. Wyomingensis), low intensity fire or mechanical treatment (Wambolt 1986) could reduce shrub competition and allow for increased vigor and the reestablishment of grass species.

## **State 3**

### **Degraded State**

Degraded State lacks midstatured bunchgrasses. Sandberg bluegrass and prairie Junegrass are dominant grasses,

and increase shrubs nearly replace larger shrub species. Remaining larger shrub species are heavily hedged. Likely a terminal state (e.g., restoration will likely be impossible or unsuccessful and require major energy inputs).

**Characteristics and indicators.** increased bare ground (excess of 25 percent) annual grasses common complete removal of deep rooted tall bunchgrasses and replaced with sandberg bluegrass, western wheatgrass, and blue grama sagebrush nearly gone and replaced with cactus rabbitbrush and broom snakeweed

### **Community 3.1 Shrub/Shortgrass Community**

Soil loss continues and subsequent loss of soil organic matter create conditions where native perennial grasses are reduced to less than 50 percent total production. Grass and forb cover may be very sparse or clumped (canopy cover less than 30 percent). Weeds, annual species or shrubs dominate the plant community. Mid-stature perennial bunchgrass species (e.g., needle-and-thread) may exist, but only in small patches. This could occur due to overgrazing (failure to adjust stocking rate to declining forage production due to increased invasive dominance), long-term lack of fire (if Wyoming big sagebrush occurs), or introduction of invasive species. In the most severe stages of degradation, there is a significant amount of bare ground, and large gaps occur between plants. Potential exists for soils to erode to the point that irreversible damage may occur. This is a critical shift in the ecology of the site. Soil erosion combined with lack of organic matter deposition due to sparse vegetation create changes to the hydrology, soil chemistry, soil microorganisms, and soil structure to the point where intensive restoration is required to restore the site to another state or community. Changing management (i.e., improving grazing management) cannot create sufficient change to restore the site within a reasonable time frame. This state is characterized by soil surface degradation and little plant soil surface cover. The forb component changes to be dominated by spiny phlox (*Phlox hoodii*) and shrub canopy cover is usually greater than 20 percent. Big sagebrush is replaced with a dominant community of broom snakeweed, rubber rabbitbrush, fringed sagewort, and plains pricklypear cactus. This state has lost soil or vegetation attributes to the point that recovery to the Reference State will require reclamation efforts, i.e. soil rebuilding, intensive mechanical treatments, and/or reseeding. This plant community may be in a terminal state that will not return to the reference state because of degraded soil conditions and loss of higher successional native plant species. Key factors of approach to transition: Decrease in grass canopy cover and production, increase of shrub canopy cover, increases in mean bare patch size, increases in soil crusting, decreases in cover of cryptobiotic crusts, decreases in soil aggregate stability, and/or evidence of erosion including water flow patterns and litter movement.

### **State 4 Invaded State**

The Invaded State is identified as being in the exponential growth phase of invader abundance where control is a priority. Dominance (or relative dominance) of noxious or invasive species reduces species diversity, forage production, wildlife habitat, and site protection. A level of 15 percent invasive species composition by dry weight indicates that a substantial energy input will be required to create a shift to the grassland state (herbicide, mechanical treatment), even with a return to proper grazing management or favorable growing conditions. Prescriptive grazing can be used to manage invasive species. In some instances, carefully targeted grazing (sometimes in combination with other treatments) can reduce or maintain the species composition of invasive species. These communities within this state will follow a pathway if the invasive or noxious species continue to thrive without mechanical, biological, or chemical control methods to exceed 50 percent of species composition by dry weight. The invasive nature of the weed outcompetes the present plant community. Once the weed reaches its maximum population level for this site, effective control is unlikely without massive resource inputs. Ecological processes at the site may change after invading species have established and spread (Walker and Smith 1997).

### **Community 4.1**

Communities in this state may be structurally indistinguishable from the Reference State except that invasive/noxious species exceed 15 percent of species composition by dry weight. This state may also include a community similar to the Degraded State (3) except that invasive/noxious species exceed 15 percent of species composition by dry weight. Although there is no research to document the level of 15 percent, this is estimated to be the point in the invasion process following the lag phase based on interpretation of Masters and Sheley 2001. For aggressive invasive species (i.e., spotted knapweed) a 15 percent threshold could be less than 10 percent. Early in the invasion process there is a lag phase where the invasive plant populations remain small and localized for long

periods before expanding exponentially (Hobbs and Humphries 1995). Production in the invaded community may vary greatly. A site dominated by Kentucky bluegrass or spotted knapweed, where soil fertility and chemistry remain near reference, may have production near that of the reference community. A site with degraded soils and an infestation of cheatgrass may produce only 10 to 20 percent of the reference community. Once invasive species dominate the site, either in species composition by weight or in their impact on the community the threshold has been crossed to the Invaded State (4). As invasive species such as spotted knapweed, cheatgrass, and leafy spurge become established, they become very difficult to eradicate. Therefore considerable effort should be placed in preventing plant communities from crossing a threshold to the Invaded State (4) through early detection and proper management. Preventing new invasions is by far the most cost-effective control strategy, and typically places an emphasis on education. Control measures used on the noxious plant species impacting this ecological site include chemical, biological, and cultural control methods. The best success has been found with an integrated pest management (IPM) strategy that incorporates one or several of these options along with education and prevention efforts (DiTomaso 2000).

## **State 5 Conifer Encroached State**

Rocky Mountain juniper (*Juniperus scopulorum*), Douglas fir (*Pseudotsuga menziesii*), and ponderosa pine (*Pinus ponderosa*) encroachment is limited on this ecological site and is generally focused in areas where the mountains of MLRA 44B transition quickly to MLRA 43B. Under the Reference State, up to two (2) stem per acres of conifers may exist as part of long-term fire suppression; however the core concept of this ecological site is to express no coniferous trees. Conifer Encroached State consists of up to 4 potential phases. The Early Phase, Mid Phase, Late Phase, and Closed Phase are defined by the amount of encroachment and age class of the stand. This state typically occurs in response to a combination of long-term fire suppression, grazing history, and increased atmospheric carbon dioxide. The trigger for transition is a coniferous expansion of more than 2 stems per acre.

### **Community 5.1 Conifer Encroachment Community**

Rocky Mountain juniper (*Juniperus scopulorum*), ponderosa pine (*Pinus ponderosa*), and Douglas fir (*Pseudotsuga menziesii*) encroachment is common on this ecological site and is generally focused in areas where the mountains of MLRA 44B transition quickly to MLRA 43B. Under the Reference State, no conifers should exist on this site. It is also noted that all states may transition to the Conifer Encroached State; however, encroachment is most likely to occur in the Altered State, where there is an increase in bare ground due to a combination of factors that allows seed-to-soil contact with reduced competition. Fire suppression and improper grazing management are the two most common triggers. The exact mode in which conifers begin to encroach varies; however, the trend points to a combination of 1 or more of the following: repeated moderately heavy to heavy grazing; reduced (non-existent) fire frequency; increased atmospheric carbon; and a generally warmer climate compared to that of pre-settlement. When heavy grazing occurs, areas in the plant canopy open, allowing for seed dispersal by bird or overland flow via rills on neighboring sites. The effects of conifer encroachment are not immediately noticeable, but over time, as the conifer canopy increases, light and water interception increase, which reduces opportunities for herbaceous plants. One paper (Barrett, 2007) suggests that for precipitation to penetrate the juniper canopy, events must be greater than 0.30 inches. Increased tree canopy creates perching sites for predators, which reduces site suitability for greater sage grouse. More information is needed on the full extent and impact of juniper encroachment on these plant communities for an approved ecological site description. Studies (Miller et al., 2000) based in an area similar to the Rocky Mountain juniper community of Montana suggest following a phased approach to characterizing the juniper stand. Not unlike the western juniper community discussed in Miller et al., the Conifer Encroached Communities of Montana exhibit three or four different phases based, at this time, on qualitative experience. Phase I (Early) is defined by actively expanding conifer cover with generally less than 10 percent canopy cover and the tree limbs generally touching the ground. This early stage generally has not completely lost its hydrologic functions, but herbaceous plant communities may show signs of reduced production and species richness. Control methods include mechanical removal and prescribed fire. Prescribed fire is still effective in this phase as it still contains the necessary native plants for recovery. The tree canopy is also low enough that the risk of a dangerously hot fire is reduced. Phase II (Midphase) is still actively expanding, but canopy cover may reach 15 to 25 percent, and due to the more mature trees, seed production is very high. This Midphase begins to highly restrict herbaceous and shrubby plants, and junipers tend to be codominant. Hydrology is departing from reference, with rills becoming longer and, in isolated areas, erosional gullies possible. Control methods for the Midphase should focus on mechanical treatment, as there is a high risk of catastrophic and potentially sterilizing fire. Phase III (Late Phase) is

where conifer cover exceeds 25 percent and has slowed as a forest condition. Lower tree limbs begin to die, and the shrub cover is nearly gone. Traveling through this community is increasingly difficult. Conifers become the dominant plant, with herbaceous plant production greatly decreasing. Bare ground increases, and hydrologic function is nearly lost compared to a grass or shrub community. The late phase should focus more on restoration than control, as the necessary plants will likely not be present to cross the threshold back to a rangeland situation. Because soil stability and hydrologic function are lacking in this phase, mechanical juniper removal will be required. Phase IV (Closed Phase) is the steady state forest, where the system is nearly devoid of rangeland plants. The trees stop producing seed and begin to close in on each other. This phase is impassable, and nearly all light and precipitation are intercepted. Bare ground may be reduced due to excessive forest duff layer. As a result, soil chemistry slowly changes due to acidification from conifer needles. The closed phase is extremely rare in this LRU for two reasons. 1) This phase takes upwards of 100 years to occur and even under suppression, fire will control these sites 2) Management often occurs before trees are allowed to reach this phase. The presence of sagebrush stumps indicates that the historical plant community was rangeland, preventing the misclassification of historic coniferous forests (often more than 100 years old).

## **Transition T1A**

### **State 1 to 2**

The Reference State (1) transitions to the Altered State (2) if mid-statured bunchgrasses, by dry weight, decrease to below 10 percent or if bare ground cover increases beyond 20 percent. The driver for this transition is the loss of taller bunchgrasses, which creates open areas in the plant canopy with bare soil. Soil erosion results in decreased soil fertility, driving transitions to the Altered State. There are several other key factors signaling the approach of transition T1A: increases in soil physical crusting, decreases in cover of cryptogamic crusts, decreases in soil surface aggregate stability, and/or evidence of erosion including water flow patterns, development of plant pedestals, and litter movement. The trigger for this transition is improper grazing management and/or long-term drought, leading to a decrease in rough fescue composition to less than 10 percent and a reduction in total plant canopy cover.

## **Transition T1B**

### **State 1 to 3**

The Reference State (1) transitions to the Degraded State (3) when mid-statured bunchgrasses are removed from the plant community and needle-and-thread is subdominant to short-statured bunchgrasses such as Sandberg bluegrass. This transition differs from T1A in that it is generally a rapid transition and usually associated with disturbances such as repeated overgrazing or heavy human traffic. This rapid transition is generally realized where livestock are confined to small pastures for long periods of time, such as horse pastures and calving lots. The driver for this transition is the loss of taller bunchgrasses, which creates openings in the canopy and exposes bare soil. Soil erosion results in decreased soil health, driving transitions to the Degraded State. There are several other key factors signaling the approach of transition T1B: increases in soil physical crusting, decreases in cover of cryptogamic crusts, decreases in soil surface aggregate stability, and/or evidence of erosion including water flow patterns, development of plant pedestals, and litter movement. The trigger for this transition is improper grazing management, long term drought, and/or heavy human disturbance.

## **Transition T1C**

### **State 1 to 4**

Healthy plant communities are most resistant to invasion. However, regardless of grazing management, without some form of active weed management (chemical, mechanical, or biological control) and prevention, the Reference State (1) can transition to the Invaded State (4) in the presence of aggressive invasive species such as spotted knapweed, leafy spurge, and cheatgrass. This will occur even if the reference community is thriving. The Central Rocky Mountain Valleys tend to resist invasion by cheatgrass; however, repeated heavy grazing or intense human activities can open the interspaces of the bunchgrass community and allow for encroachment. Long-term stress conditions for native species (e.g., overgrazing, drought, and fire) accelerate this transition. If populations of invasive species reach critical levels, the site transitions to the Invaded State. The trigger for this transition is the presence of aggressive invasive species. The species composition by dry weight of invasive species approaches 10 percent.

## **Transition T1D**

### **State 1 to 5**

The transition from the Reference State (1) to the Conifer Encroached State (5) is driven primarily by long-term fire suppression, but heavy grazing may contribute to increased bare ground for seeding sites. Encroachment occurs most quickly within 200 feet of the seed source. The trigger for transition is a conifer stem count greater than two (2) per acre.

## **Restoration pathway R2A**

### **State 2 to 1**

The Altered State (2) has lost soil or vegetation attributes to the point that recovery to the Reference State (1) will require reclamation efforts such as soil rebuilding, intensive mechanical and cultural treatments, and/or revegetation. Examples of mechanical treatment may be brush control, while cultural treatments may include prescribed grazing, targeted brush browsing, or prescribed burning. Low intensity prescribed fires to reduce competitive increaser plants such as needle and thread and Sandberg bluegrass. A low-intensity fire will also reduce Wyoming big sagebrush densities. In areas with the potential for annual grass infestations, fire should be carefully planned or avoided. The drivers for this restoration pathway are reclamation efforts along with proper grazing management.

## **Transition T2A**

### **State 2 to 3**

As improper grazing management continues, the vigor of bunch grasses will decrease and the shorter grasses and shrubs will increase, leading to the Degraded State (3). Prolonged drought will provide a competitive advantage to shrubs, allowing them to become co-dominant with grasses. Shrub canopy will increase above 15 percent canopy cover. Key transition factors include: an increase in native shrub canopy cover; a reduction in bunchgrass production; a decrease in total plant canopy cover and production; increases in mean bare patch size; increases in soil crusting; decreases in the cover of cryptobiotic crusts; decreases in soil aggregate stability; and/or evidence of erosion, including water flow patterns and litter movement.

## **Transition T2B**

### **State 2 to 4**

Invasive species can occupy the Altered State (2) and drive it to the Invaded State (4). The Altered State is at risk if invasive seeds and/or other viable material are present. The driver for this transition is more than 10 percent by dry weight of invasive species.

## **Transition T2C**

### **State 2 to 5**

The transition from the Altered State (2) to the Conifer Encroached State (5) is driven primarily by long-term fire suppression, but heavy grazing may contribute to increased bare ground for seeding sites. Encroachment occurs most quickly within 200 feet of the seed source. The trigger for transition is a conifer stem count greater than two (2) per acre.

## **Restoration pathway R3A**

### **State 3 to 1**

The Degraded State (3) has lost soil or vegetation attributes to the point that recovery to the Reference State (1) will require reclamation efforts, such as soil rebuilding, intensive mechanical treatments, and/or revegetation. Studies suggest (Whitford et al. 1989) that a mulch with a high carbon to nitrogen ratio, such as wood chips or bark, in low moisture scenarios can be beneficial for slow mobilization of plant-available nitrogen. Biochar may also be added to the system to improve Soil Organic Carbon (SOC) which should improve Cation Exchange Capacity (CEC), microbial activity, and hydrologic conductivity (Stavi 2012). The drivers for the restoration pathway are the removal of increaser species, restoration of native bunchgrass species, persistent management of invasives and shrubs, and proper grazing management. Without continued control, invasive and shrub species are likely to return



(probably rapidly) due to the presence of seeds and/or other viable material in the soil and management-related increases in soil disturbance.

### **Restoration pathway R3B**

#### **State 3 to 2**

Since the bunchgrass plant community has been significantly reduced, restoration to the Altered State (2) is unlikely unless a seed source is available. However, if a sufficient amount of grass remains on the site, chemical application and/or biological control, in conjunction with proper grazing management, can reduce the amount of shrubs and invasive species and restore the site to the Shortgrass Community (2.2). Low-intensity fire can be utilized to reduce Wyoming big sagebrush competition and allow the reestablishment of grass species. Caution must be used when considering fire as a management tool on sites with fire-tolerant shrubs such as rubber rabbitbrush, as these shrubs will sprout after a burn. Broom snakeweed and fringed sagewort may or may not re-sprout depending on conditions (USDA Forest Service, 2011).

### **Transition T3A**

#### **State 3 to 4**

Invasive species can occupy the Degraded State (3) and drive it to the Invaded State (4). The Degraded State is at risk of this transition occurring if invasive seeds or viable material are present. The driver for this transition is the presence of critical population levels (more than 10 percent dry weight of invasive species). The trigger is the presence of seeds or viable material from invasive species. This state has sufficient bare ground that the transition could occur simply due to the presence or introduction of invasive seeds or viable material. This is particularly true of aggressive invasive species such as spotted knapweed. This transition could be assisted by overgrazing (failure to adjust stocking rate to declining forage production), a long-term lack of fire, or an extensive drought.

### **Transition T3B**

#### **State 3 to 5**

The transition from the Degraded State (3) to the Conifer Encroached State (5) is driven primarily by heavy grazing; contributing to increased bare ground for seeding sites. Encroachment occurs most quickly within 200 feet of the seed source. The trigger for transition is a conifer stem count greater than two (2) per acre.

### **Restoration pathway R4A**

#### **State 4 to 1**

If invasive species are removed before remnant populations of bunchgrass have been drastically reduced, the Invaded State (4) can return to the Reference State. The driver for the reclamation pathway is weed management with reseeding. Continued Integrated Pest Management (IPM) will be required as many of the invasive species that can occupy the Invaded State have extended dormant seed life.

### **Restoration pathway R4B**

#### **State 4 to 2**

If invasive species are removed before remnant populations of bunchgrass have been drastically reduced, the Invaded State (4) can return to the Altered State. The driver for the reclamation pathway is weed management with reseeding. Continued Integrated Pest Management (IPM) will be required as many of the invasive species that can occupy the Invaded State have extended dormant seed life.

### **Restoration pathway R4C**

#### **State 4 to 3**

If invasive species are removed before remnant populations of bunchgrass have been drastically reduced, the Invaded State (4) can return to the Degraded State. The driver for the reclamation pathway is weed management with reseeding. Continued Integrated Pest Management (IPM) will be required as many of the invasive species that can occupy the Invaded State have extended dormant seed life.

## **Transition T4A**

### **State 4 to 5**

The transition from the Invaded State (4) to the Conifer Encroached State (5) is driven primarily by heavy grazing; contributing to increased bare ground for seeding sites. Encroachment occurs most quickly within 200 feet of the seed source. The trigger for transition is a conifer stem count greater than two (2) per acre.

## **Restoration pathway R5A**

### **State 5 to 1**

Restoration efforts may simply focus on the removal of coniferous trees and shrubs to restore the Conifer Encroached State (5) to the Reference State (1), depending on the level of conifer canopy cover and its impact on rangeland health. If following and utilizing the phases established by Miller et al., management and restoration methods will vary. A majority of the conifer encroachment in MLRA 44B will fall into the early two phases of Miller's phases. When conifers are removed through brush management and/or prescribed fire, Phase I may reveal none-to-slight to moderate deviations from rangeland health. If mechanical removal of conifers is utilized, no grazing management is needed, assuming relatively conservative management had been used prior to treatment. If prescribed fire is utilized, short-term grazing deferment and/or rest are suggested. In a short period of time, removing a Phase I encroachment will return the site to its original state. Proactive pest management is encouraged. Phase II encroachment may require a more intensive mechanical removal of trees and shrubs, with prescribed fire not being a feasible method of control as this community may be at risk of catastrophic fire due to canopy density. Phase II displays a moderate departure from Reference, suggesting an overall instability of the site such as reduced herbaceous production, reduced functional and structural groups (e.g., reduced mid-statured bunchgrasses), increased rill frequency and length, and possibly more bare ground. Increased post-treatment grazing management may be necessary. Grazing management may be as simple as short-term growing season deferment; however, long-term rest may be necessary in the latter stages of Phase II encroachment. The latter stages of Phase II encroachment will likely require some short-term erosion mitigation, such as straw wattles, as well as range planting and/or critical area planting to re-establish any loss of native herbaceous plants, particularly mid-statured cool-season bunchgrasses. Phase III encroachment canopy cover resembles forested sites with larger trees and shrubs. Prior to any prescribed burning, forest management-style tree removal (removal of woody debris and logs from the site) will be required to prevent the fire from burning too hot. The result of a prescribed fire on this site is typically unknown as seed sources of native herbaceous plants are usually limited to small patches. Since the Shallow Loamy ecological site for 44B LRU 01 Subset B is a dry site, herbaceous plants will likely have been depleted under a Phase III encroachment. This means there is an opportunity for large areas of bare ground, increased rills, and, in some cases, gully erosion. Post-treatment will require range planting and/or critical area seeding, erosion control, pest management, and possibly soil carbon amendments (biochar). Grazing management (primarily rest) will be required to ensure the establishment of any new seedlings.

## **Restoration pathway R5B**

### **State 5 to 2**

The Conifer Encroached State (5) Phases I and II will generally resemble the Altered State (2) on this site. If following and utilizing the phases established by Miller et al., management and restoration methods will vary. A majority of the conifer encroachment in MLRA 44B will fall into the early two phases of Miller's phases. When conifers are removed through brush management and/or prescribed fire, Phase I may show none-to-slight to moderate deviations from rangeland health. If mechanical removal of conifers is utilized, no grazing management is needed, assuming relatively conservative management had been used prior to treatment. If prescribed fire is utilized, short-term grazing deferment and/or rest are suggested. In a short period of time, removing a Phase I encroachment will return the site to its original state. Proactive pest management is encouraged. Phase II encroachment may require a more intensive mechanical removal of trees and shrubs, with prescribed fire not being a feasible method of control as this community may be at risk of catastrophic fire due to canopy density. Phase II displays a moderate departure from Reference, suggesting an overall instability of the site such as reduced herbaceous production, reduced functional and structural groups (e.g., reduced mid-statured bunchgrasses), increased rill frequency and length, and possibly more bare ground. Increased post-treatment grazing management may be necessary. Grazing management may be as simple as short-term growing season deferment; however, long-term rest may be necessary in the latter stages of Phase II encroachment. The latter stages of Phase II encroachment will likely require some short-term erosion mitigation such as straw wattles as well as range planting and/or critical area planting to re-establish any loss of native herbaceous plants, particularly mid-statured cool-

season bunchgrasses. Phase III encroachment canopy cover resembles forested sites with larger trees and shrubs. Prior to any prescribed burning, forest management-style tree removal (removal of woody debris and logs from the site) will be required to prevent the fire from burning too hot. The result of a prescribed fire on this site is typically unknown as seed sources of native herbaceous plants are usually limited to small patches. Since the Shallow Loamy ecological site for 44B LRU 01 Subset B is a dry site, herbaceous plants will likely have been depleted under a Phase III encroachment. This means there is an opportunity for large areas of bare ground, increased rills, and, in some cases, gully erosion. Post-treatment will require range planting and/or critical area seeding, erosion control, pest management, and possibly soil carbon amendments (biochar). Grazing management (primarily rest) will be required to ensure the establishment of any new seedlings.

## **Restoration pathway R5C State 5 to 3**

The Conifer Encroached State (5) Phases II and III may resemble the Degraded State (3) on this site. If following and utilizing the phases established by Miller et al., management and restoration methods will vary. An overwhelming majority of the conifer encroachment in MLRA 44B will fall into the early two phases of Miller's phases. This restoration pathway is extremely rare because managing a degraded state is typically not cost-effective for land managers. When conifers are removed through brush management and/or prescribed fire, Phase I may show none-to-slight to moderate deviations from rangeland health. If mechanical removal of conifers is utilized, no grazing management is needed, assuming relatively conservative management had been used prior to treatment. If prescribed fire is utilized, short-term grazing deferment and/or rest are suggested. Given a short time removal of a Phase I encroachment will recover to Reference. Proactive pest management is encouraged. Phase II Encroachment may require a more intensive mechanical removal of trees and shrubs, with prescribed fire not being a feasible method of control as this community may be at risk of catastrophic fire due to canopy density. Phase II displays a moderate departure from Reference, suggesting an overall instability of the site such as reduced herbaceous production, reduced functional and structural groups (e.g., reduced mid-statured bunchgrasses), increased rill frequency and length, and possibly more bare ground. Increased post-treatment grazing management may be necessary. Grazing management may be as simple as short-term growing season deferment; however, long-term rest may be necessary in the latter stages of Phase II encroachment. The latter stages of Phase II encroachment will likely require some short-term erosion mitigation, such as straw waddles, as well as range planting and/or critical area planting to re-establish any loss of native herbaceous plants, particularly mid-statured cool-season bunchgrasses. Phase III Encroachment canopy cover resembles forested sites with larger trees and shrubs. Forest management style tree removal (woody debris and logs removed from the site) will be necessary prior to any prescribed burning as to prevent the fire from burning too hot. The results of a prescribed fire on this site are typically unknown as seed sources of native herbaceous plants are usually limited to small patches. Since the Shallow Loamy ecological site for 44B LRU 01 Subset B is a dry site, herbaceous plants will likely have been depleted under a Phase III encroachment. This means there is an opportunity for large areas of bare ground, increased rills, and, in some cases, gully erosion. Post-treatment will require range planting and/or critical area seeding, erosion control, pest management, and possibly soil carbon amendments (biochar). Grazing management (primarily rest) will be required to ensure the establishment of any new seedlings.

## **Additional community tables**

**Table 8. Community 1.1 plant community composition**

Group	Common Name	Symbol	Scientific Name	Annual Production (Kg/Hectare)	Foliar Cover (%)
<b>Grass/Grasslike</b>					
1	<b>Mid-Statured Bunchgrasses</b>			908–981	
	rough fescue	FECA4	<i>Festuca campestris</i>	504–785	25–35
	bluebunch wheatgrass	PSSP6	<i>Pseudoroegneria spicata</i>	448–673	20–30
	green needlegrass	NAVI4	<i>Nassella viridula</i>	112–179	10–15
2	<b>Rhizomatous Grasses</b>			67–140	
	western wheatgrass	PASM	<i>Pascopyrum smithii</i>	45–112	2–5
	thickspike wheatgrass	ELLA3	<i>Elymus lanceolatus</i>	0–112	0–5
	plains reedgrass	CAMO	<i>Calamagrostis montanensis</i>	22–45	1–2
3	<b>Shortgrasses/grasslikes</b>			67–140	
	Idaho fescue	FEID	<i>Festuca idahoensis</i>	28–84	3–10
	needle and thread	HECO26	<i>Hesperostipa comata</i>	34–84	5–10
	threadleaf sedge	CAFI	<i>Carex filifolia</i>	22–67	2–6
	Sandberg bluegrass	POSE	<i>Poa secunda</i>	22–67	2–6
	prairie Junegrass	KOMA	<i>Koeleria macrantha</i>	22–67	1–6
	sedge	CAREX	<i>Carex</i>	0–45	0–2
	blue grama	BOGR2	<i>Bouteloua gracilis</i>	0–11	0–1
<b>Forb</b>					
4	<b>Forbs</b>			67–112	
	lupine	LUPIN	<i>Lupinus</i>	22–34	1–3
	American vetch	VIAM	<i>Vicia americana</i>	22–34	1–3
	scarlet globemallow	SPCO	<i>Sphaeralcea coccinea</i>	11–22	1–3
	dotted blazing star	LIPU	<i>Liatris punctata</i>	0–22	0–1
	spiny phlox	PHHO	<i>Phlox hoodii</i>	0–11	0–1
	deathcamas	ZIGAD	<i>Zigadenus</i>	0–6	0
<b>Shrub/Vine</b>					
5	<b>Shrubs</b>			67–112	
	big sagebrush	ARTR2	<i>Artemisia tridentata</i>	67–112	10–15
	common snowberry	SYAL	<i>Symphoricarpos albus</i>	11–56	1–5
	Woods' rose	ROWO	<i>Rosa woodsii</i>	0–22	0–3
	currant	RIBES	<i>Ribes</i>	0–22	0–2
	yellow rabbitbrush	CHVI8	<i>Chrysothamnus viscidiflorus</i>	0–22	0–2
6	<b>Subshrubs</b>			11–34	
	winterfat	KRLA2	<i>Krascheninnikovia lanata</i>	11–34	1–3
	prairie sagewort	ARFR4	<i>Artemisia frigida</i>	0–11	0–1
	broom snakeweed	GUSA2	<i>Gutierrezia sarothrae</i>	0–11	0–1
<b>Tree</b>					
7	<b>Coniferous Trees and Tall Shrubs</b>			0–11	
	ponderosa pine	PIPOS	<i>Pinus ponderosa var. scopulorum</i>	0–11	0–1
	Rocky Mountain juniper	JUSC2	<i>Juniperus scopulorum</i>	0–11	0–1
	Douglas-fir	PSME	<i>Pseudotsuga menziesii</i>	0–11	0–1

## **Animal community**

The Shallow Loamy ecological site provides a variety of wildlife habitats for an array of species. Prior to the settlement of this area, large herds of antelope, elk, and bison roamed. Though the bison have been replaced, mostly with domesticated livestock, elk and antelope still frequently utilize this largely intact landscape.

Greater sage grouse may be present on sites with suitable habitat, typically requiring a minimum of 15 percent sagebrush canopy cover (Wallestad 1975). The Rough Fescue Community (1.1) is likely to have this minimum sagebrush cover for sage grouse presence given its low to moderate sagebrush canopy cover. Also, the potentially diverse forb component of the Reference State may provide important early-season (spring) foraging habitat for the greater sage grouse.

Managed livestock grazing is suitable on this site due to the potential to produce an abundance of high-quality forage. This is often a preferred site for grazing by livestock, and animals tend to congregate in these areas. In order to maintain the productivity of the Shallow Loamy site, grazing on adjoining sites with less production must be managed carefully to be sure utilization on this site is not excessive. Management objectives should include maintenance or improvement of the native plant community. Careful management of the timing and duration of grazing is important. Shorter grazing periods and adequate deferment during the growing season are recommended for plant maintenance, health, and recovery. According to McLean et al., early-season defoliation of bluebunch wheatgrass can result in high mortality and reduced vigor in plants. They also suggest, based on prior studies, that regrowth is necessary before dormancy to reduce injury of bluebunch.

Since needle and thread normally matures earlier than bluebunch wheatgrass and rough fescue and produces a sharp awn, this species is usually avoided after seed set. Changing the grazing season of use will help utilize needle and thread more efficiently while preventing overuse of bluebunch wheatgrass and rough fescue.

The grazing season has more influence on winterfat than grazing intensity. Late winter or early spring grazing is detrimental. However, early winter grazing may actually be beneficial (Blaisdell 1984).

Continual non-prescribed grazing of this site will be detrimental, will alter the plant composition and production over time, and will result in the transition to the Altered State. The transition to other states will depend on the duration of poorly managed grazing as well as other circumstances such as weather conditions and fire frequency.

The Altered State is subject to further degradation to the Degraded State or Invaded State. Management should focus on grazing management strategies that will prevent further degradation, such as seasonal grazing deferment or winter grazing where feasible. Communities within this state are still stable and healthy under proper management. Forage quantity and/or quality may be substantially decreased from the Reference State.

Grazing is possible in the Invaded State. Invasive species are generally less palatable than native grasses. Forage production is typically greatly reduced in this state. Due to the aggressive nature of invasive species, sites in the Invaded State face an increased risk of further degradation. Grazing has to be carefully managed to avoid further soil loss and degradation and possible livestock health issues.

Prescriptive grazing can be used to manage invasive species. In some instances, carefully targeted grazing (sometimes in combination with other treatments) can reduce or maintain the species composition of invasive species. In the Degraded State, grazing may be possible but is generally not economically and/or environmentally sustainable.

## **Hydrological functions**

The hydrologic cycle functions best in the Reference State (1) with good infiltration and deep percolation of rainfall; however, the cycle degrades as the vegetation community declines. Rapid rainfall infiltration, high soil organic matter, good soil structure, and good porosity accompany high bunchgrass canopy cover. High ground cover reduces raindrop impact on the soil surface, which keeps erosion and sedimentation transport low. Water leaving the site will have a minimal sediment load, which allows for high water quality in associated streams. High rates of infiltration will allow water to move below the rooting zone during periods of heavy rainfall. The Rough Fescue Community (1.1) should have no rills or gullies present, and drainage ways should be vegetated and stable. Water

flow patterns, if present, will be barely observable. Plant pedestals are essentially nonexistent. Plant litter remains in place and is not moved by wind or water.

Improper grazing management results in a community shift to the Mixed Bunchgrass Community (1.2). This plant community has a similar canopy cover, but the bare ground will be less than 15 percent. Therefore, the hydrologic cycle is functioning at a level similar to the water cycle in the Rough Fescue Community (1.1).

In the Shortgrass Community (2.2), Degraded State (3) and the Invaded State (4) canopy and ground cover are greatly reduced compared to the Reference State (1), which impedes the hydrologic cycle. Infiltration will decrease and runoff will increase due to reduced ground cover, the presence of shallow-rooted species, rainfall splash, soil capping, reduced organic matter, and poor structure. Sparse ground cover and decreased infiltration can combine to increase the frequency and severity of flooding within a watershed. Soil erosion is accelerated, the quality of surface runoff is poor, and sedimentation increases.

The hydrology of the Conifer Encroached State (5) is highly variable, but studies suggest that an increased tree canopy affects the interception of rainfall and reduces available soil moisture for herbaceous vegetation. This can negatively affect infiltration and increase runoff.

### **Recreational uses**

This site provides recreational opportunities for wildlife viewing, hiking, horseback riding, big game hunting, and upland bird hunting. Some plants have flowers that appeal to photographers. This site provides valuable open space.

### **Wood products**

none

### **Other products**

none

### **Inventory data references**

Information presented was derived from the site's Range Site Description, NRCS clipping data, literature, field observations, and personal contacts with range-trained personnel (i.e., used professional opinion of agency specialists, observations of land managers, and outside scientists).

### **References**

. Fire Effects Information System. <http://www.fs.fed.us/database/feis/>.

. 2021 (Date accessed). USDA PLANTS Database. <http://plants.usda.gov>.

Arno, S.F. and G.E. Gruell. 1982. Fire History at the Forest-Grassland Ecotone in Southwestern Montana. *Journal of Range Management* 36:332–336.

Barrett, H. 2007. *Western Juniper Management: A Field Guide*.

Bestelmeyer, B., J.R. Brown, J.E. Herrick, D.A. Trujillo, and K.M. Havstad. 2004. Land Management in the American Southwest: a state-and-transition approach to ecosystem complexity. *Environmental Management* 34:38–51.

- Bestelmeyer, B. and J. Brown. 2005. State-and-Transition Models 101: A Fresh look at vegetation change.
- Blaisdell, J.P. 1958. Seasonal development and yield of native plants on the Upper Snake River Plains and their relation to certain climate factors.
- Blaisdell, J.P. and R.C. Holmgren. 1984. Managing Intermountain Rangelands--Salt-Desert Shrub Ranges. General Tech Report INT-163. USDA Forest Service, Intermountain Forest and Range Experiment Station, Ogden, UT. 52.
- Bunting, S.C., B.M. Kilgore, and C.L. Bushey. 1987. Guidelines for Prescribe burning sagebrush-grass rangelands in the Northern Great Basin. General Technical Report INT-231. USDA Forest Service Intermountain Research Station, Ogden, UT. 33.
- Colberg, T.J. and J.T. Romo. 2003. Clubmoss effects on plant water status and standing crop. *Journal of Range Management* 56:489–495.
- Daubenmire, R. 1970. Steppe vegetation of Washington.
- DiTomaso, J.M. 2000. Invasive weeds in Rangelands: Species, Impacts, and Management. *Weed Science* 48:255–265.
- Dormaar, J.F., B.W. Adams, and W.D. Willms. 1997. Impacts of rotational grazing on mixed prairie soils and vegetation. *Journal of Range Management* 50:647–651.
- Hobbs, J.R. and S.E. Humphries. 1995. An integrated approach to the ecology and management of plant invasions. *Conservation Biology* 9:761–770.
- Kuchler, A.W. 1964. Potential natural vegetation of the conterminous United States.
- Lacey, J.R., C.B. Marlow, and J.R. Lane. 1989. Influence of Spotted knapweed (*Centaurea maculosa*) on surface runoff and sediment yield.. *Weed Technology* 3:627–630.
- Lesica, P. and S.V. Cooper. 1997. Presettlement vegetation of Southern Beaverhead County, MT.
- Manske, L.L. 1980. Habitat, phenology, and growth of selected sandhills range plants.
- Masters, R. and R. Sheley. 2001. Principles and practices for managing rangeland invasive plants. *Journal of Range Management* 38:21–26.
- McCalla, G.R., W.H. Blackburn, and L.B. Merrill. 1984. Effects of Livestock Grazing on Infiltration Rates of the Edwards Plateau of Texas. *Journal of Range Management* 37:265–269.
- McLean, A. and S. Wikeem. 1985. Influence of season and intensity of defoliation on bluebunch wheatgrass survival and vigor in southern British Columbia. *Journal of Range Management* 38:21–26.

- Miller, R.F., T.J. Svejcar, and J.A. Rose. 2000. Impacts of western juniper on plant community composition and structure. *Journal of Range Management* 53:574–585.
- Moulton, G.E. and T.W. Dunlay. 1988. *The Journals of the Lewis and Clark Expedition*. Pages in University of Nebraska Press.
- Mueggler, W.F. and W.L. Stewart. 1980. *Grassland and Shrubland Habitat Types of Western Montana*.
- Pelant, M., P. Shaver, D.A. Pyke, and J.E. Herrick. 2005. Interpreting Indicators of Rangeland Health.
- Pellant, M. and L. Reichert. 1984. Management and Rehabilitation of a burned winterfat community in Southwestern Idaho. Proceedings--Symposium on the biology of Atriplex and related Chenopods. 1983 May 2-6; Provo UT General Technical Report INT-172.. USDA Forest Service Intermountain Forest and Range Experiment Station. 281–285.
- Pitt, M.D. and B.M. Wikeem. 1990. Phenological patterns and adaptations in an Artemisia/Agropyron plant community. *Journal of Range Management* 43:350–357.
- Pokorny, M.L., R. Sheley, C.A. Zabinski, R. Engel, T.J. Svejcar, and J.J. Borkowski. 2005. Plant Functional Group Diversity as a Mechanism for Invasion Resistance.
- Wambolt, C. and G. Payne. 1986. An 18-Year Comparison of Control Methods for Wyoming Big Sagebrush in Southwestern Montana. *Journal of Range Management* 39:314–319.
- West, N.E. 1994. Effects of Fire on Salt-Desert shrub rangelands. Proceedings--Ecology and Management of Annual Rangelands: 1992 May 18-22. Boise ID General Technical Report INT-GTR-313.. USDA Forest Service Intermountain Research Station. 71–74.
- Whitford, W.G., E.F. Aldon, D.W. Freckman, Y. Steinberger, and L.W. Parker. 1989. Effects of Organic Amendments on Soil Biota on a Degraded Rangeland. *Journal of Range Management* 41:56–60.
- Wilson, A.M., G.A. Harris, and D.H. Gates. 1966. Cumulative Effects of Clipping on Yield of Bluebunch wheatgrass. *Journal of Range Management* 19:90–91.

## **Contributors**

Petersen

## **Approval**

Kirt Walstad, 9/11/2023

## **Rangeland health reference sheet**

Interpreting Indicators of Rangeland Health is a qualitative assessment protocol used to determine ecosystem condition based on benchmark characteristics described in the Reference Sheet. A suite of 17 (or more) indicators are typically considered in an assessment. The ecological site(s) representative of an assessment location must be known prior to applying the protocol and must be verified based on soils and climate. Current plant community cannot be used to identify the ecological site.



Author(s)/participant(s)	Grant Petersen
Contact for lead author	grant.petersen@usda.gov
Date	03/01/2020
Approved by	Kirt Walstad
Approval date	
Composition (Indicators 10 and 12) based on	Annual Production

## Indicators

1. **Number and extent of rills:** Rills will primarily be absent on gentle slopes however on the steepest of slopes of this site (greater than 30 percent) small, short rills (less than 2-3 feet) may be evident after high precipitation events.  

---
2. **Presence of water flow patterns:** Water flow patterns are rare in the reference condition. If present, they are most likely to occur on steeper slopes (greater than 20 percent) and are inconspicuous, disconnected, and very short in length.  

---
3. **Number and height of erosional pedestals or terracettes:** Pedestals are not evident in the reference condition  

---
4. **Bare ground from Ecological Site Description or other studies (rock, litter, lichen, moss, plant canopy are not bare ground):** Bare ground is between 5 and 15 percent  

---
5. **Number of gullies and erosion associated with gullies:** Gullies are not present in the reference condition.  

---
6. **Extent of wind scoured, blowouts and/or depositional areas:** Wind scoured, or depositional areas are not evident in the reference condition.  

---
7. **Amount of litter movement (describe size and distance expected to travel):** Movement of fine herbaceous litter may occur within less than a foot from where it originated.  

---
8. **Soil surface (top few mm) resistance to erosion (stability values are averages - most sites will show a range of values):** Soil Surface Stable with Stability Ratings of 4-6 (both under canopy and bare). Biotic crusts and/or root mats may be present.  

---
9. **Soil surface structure and SOM content (include type of structure and A-horizon color and thickness):** Structure trends to weak, fine granular. The A horizon is approximately 3 inches thick with wet Munsell colors Value 5 or less, Chroma 3 or less. Dry colors tend to be quite light prior to wetting. Official Series Description (OSD) for characteristic range.  

---

10. **Effect of community phase composition (relative proportion of different functional groups) and spatial distribution on infiltration and runoff:** Evenly distributed across the site, bunchgrasses improve infiltration while rhizomatous grass protects the surface from runoff forces. The Shallow Loamy ecological site is well drained and has a moderately rapid infiltration rate. An even distribution of mid stature grasses (approximately 65 to 70 percent of site production) with cool season rhizomatous grasses accounting for 10 percent of site production along with a mix of shortgrasses (5-15 percent), forbs and shrubs (5-10 percent each). Trees and tall coniferous shrubs may be present as a trace on this site (less than 1 stem per acre)
- 

11. **Presence and thickness of compaction layer (usually none; describe soil profile features which may be mistaken for compaction on this site):** Not Present
- 

12. **Functional/Structural Groups (list in order of descending dominance by above-ground annual-production or live foliar cover using symbols: >>, >, = to indicate much greater than, greater than, and equal to):**

Dominant: Mid-statured, cool season, perennial bunchgrasses

Sub-dominant: perennial shortgrasses/grasslikes  $\geq$  rhizomatous grasses  $\geq$  shrubs = forbs >> trees

Other:

Additional:

---

13. **Amount of plant mortality and decadence (include which functional groups are expected to show mortality or decadence):** Mortality in herbaceous species is not evident. Species with bunch growth forms may have some natural mortality in centers.
- 

14. **Average percent litter cover (%) and depth ( in):** Total litter cover ranges from 30-35 percent. Most litter is irregularly distributed on the soil surface and is typically less than 1/2 inch deep.
- 

15. **Expected annual annual-production (this is TOTAL above-ground annual-production, not just forage annual-production):** Average annual production is 1265 pounds per acre (lbs/ac) or 1418 kilograms per hectare (kg/ha)  
Low: 940 lbs/acre or 1054 kg/ha  
High 1510 lb/ac or 1692 kg/ha  
Production varies based on effective precipitation and natural variability of soil properties for this ecological site.
- 

16. **Potential invasive (including noxious) species (native and non-native). List species which BOTH characterize degraded states and have the potential to become a dominant or co-dominant species on the ecological site if their future establishment and growth is not actively controlled by management interventions. Species that become dominant for only one to several years (e.g., short-term response to drought or wildfire) are not invasive plants. Note that unlike other indicators, we are describing what is NOT expected in the reference state for the ecological site:** Potential invasive (including noxious) species (native and non-native). Invasive species on this ecological site include (but not limited to) annual brome spp., spotted knapweed, yellow toadflax, leafy spurge, ventenata, crested wheatgrass, etc.

Native species such as Rocky Mountain juniper, ponderosa pine, Douglas fir, broom snakeweed, rabbitbrush spp., blue

grama, Sandberg bluegrass, etc. when their populations are significant enough to affect ecological function, indicate site condition departure.

---

17. **Perennial plant reproductive capability:** In the reference condition, all plants are vigorous enough for reproduction either by seed or rhizomes in order to balance natural mortality with species recruitment. Density of plants indicates that plants reproduce at level sufficient to fill available resource.
-