

Ecological site EX044B01C032 Loamy (Lo) LRU 01 Subset C

Last updated: 9/07/2023
Accessed: 04/25/2024

General information

Provisional. A provisional ecological site description has undergone quality control and quality assurance review. It contains a working state and transition model and enough information to identify the ecological site.

MLRA notes

Major Land Resource Area (MLRA): 044B–Central Rocky Mountain Valleys

Major Land Resource Area (MLRA) 44B, Central Rocky Mountain Valleys, is nearly 3.7 million acres of Southwest Montana. This MLRA borders two MLRAs: 43B Central Rocky Mountains and Foothills, and MLRA 46 Northern and Central Rocky Mountain Foothills.

The major watersheds of this MLRA are the Missouri and Yellowstone Rivers along with their associated headwaters such as the Beaverhead, Big Hole, Jefferson, Ruby, Madison, Gallatin, and Shields Rivers. Limited portions of the MLRA are west of the Continental Divide along the Clark Fork River. These waters allow for extensive irrigation for crop production in an area that would generally be only compatible with rangeland and grazing. The Missouri River and its headwaters are contained behind several reservoirs used for irrigation water, hydroelectric power, and municipal water.

The primary land use of this MLRA is production agriculture (grazing, small grain production, and hay) with limited mining. Urban Development is also high.

MLRA 44B consists of one Land Resource Unit (LRU) and seven Climate-based LRU subsets. Annual precipitation ranges from a low of 9 inches to a high near 24 inches. The driest areas tend to be in the valley bottoms of southwest Montana in the rain shadow of the mountains. The wettest areas tend to be near the edges of the MLRA where it borders with MLRA 43B. Frost Free periods also vary greatly with from less than 30 days in the Big Hole Valley to approximately 110 days in the warm valleys along the Yellowstone River and Missouri River Headwaters.

MLRA 44B's plant communities are highly variable however are dominated by a cool season grass and shrub steppe community on the rangeland and a mixed coniferous forest in the mountains. Warm season grasses occupy an extremely limited extent in this MLRA. Most subspecies of big sagebrush are present, to some extent, across the MLRA.

LRU notes

LRU 01 Subset C Central Concept:

- Moisture Regime: Ustic
- Temperature Regime: Frigid, cool
- Dominant Cover: rangeland (mixed grassland and sagebrush steppe)
- Representative Value (RV) of range of Effective Precipitation: 14-19 inches (355.6mm-482.6)
- Representative Value (RV) of range of Frost Free Days: 70-105 days

Subset C exists near the cities of Anaconda, Bozeman, Livingston, and Wilsall.

For further information regarding MLRAs refer to:

http://www.nrcs.usda.gov/wps/portal/nrcs/detail/soils/survey/?cid=nrcs142p2_053624

Classification relationships

Mueggler and Stewart. 1980. Grassland and Shrubland habitat types of Western Montana

1. *Artemisia tridentata*/Festuca scabrella h.t.
2. *Artemisia tridentata*/Festuca idahoensis h.t.
3. *Artemisia tripartita*/Festuca idahoensis h.t.

EPA Ecoregions of Montana, Second Edition:

Level I: Northwestern Forested Mountains

Level II: Western Cordillera

Level III: Middle Rockies & Northern Great Plains

Level IV:

Shield-Smith Valleys

Deer Lodge-Philipsburg-Avon Grassy Intermontane Hills and Valleys

Townsend Basin

Paradise Valley

National Hierarchical Framework of Ecological Units:

Domain: Dry

Division: M330 – Temperate Steppe Division – Mountain Provinces

Province: M332 – Middle Rocky Mountain Steppe – Coniferous Forest – Alpine Meadow

Section: M332D – Belt Mountains Section

M332E – Beaverhead Mountains Section

Subsection: M332Ej – Southwest Montana Intermontane Basins and Valleys

M332Dk – Central Montana Broad Valleys

Ecological site concept

- Site does not receive any additional water
- Soils are
 - o Not saline or saline-sodic
 - o Moderately deep, deep, or very deep
 - o Typically less than 5 percent stone and boulder cover with 15 percent maximum
 - o Not Skeletal (less than 35 percent rock fragments) at 10 to 20 inch control section
 - o Not strongly or violently effervescent within surface mineral 4 inches; calcium carbonate may increase with depth
- Soil surface texture ranges from sandy loam to clay loam in surface mineral 4 inches
- Clay content is less than 32 percent in surface mineral 4 inches.
- If present, an argillic horizon will have less than 35 percent clay.
- An area of dissected mountain valleys. The valleys are typically bordered by mountains trending north to south.
- Parent material is alluvium and colluvium (limited extent)

Slope is less than 15 percent

Table 1. Dominant plant species

Tree	Not specified
Shrub	(1) <i>Artemisia tridentata</i> ssp. <i>vaseyana</i> (2) <i>Artemisia tripartita</i>
Herbaceous	(1) <i>Festuca campestris</i> (2) <i>Festuca idahoensis</i>

Legacy ID

R044BC032MT

Physiographic features

This ecological site occurs on alluvial fans, low hills, fan remnants, valley floors, outwash plains, and hills. The site can exist on slopes ranging from 1 to 15 percent however the core concept slopes of this ecological site is two to eight percent. Aspect is variable; however, east or west facing slopes are most common as the valleys are north and south oriented, paralleling the area mountains.

Table 2. Representative physiographic features

Landforms	(1) Intermontane basin > Alluvial fan (2) Intermontane basin > Fan remnant (3) Intermontane basin > Hill (4) Intermontane basin > Valley floor (5) Intermontane basin > Outwash plain
Elevation	5,120–6,350 ft
Slope	1–15%

Climatic features

The Central Rocky Mountain Valleys MLRA has a continental climate. Fifty to sixty percent of the annual long-term average total precipitation falls between May and August. Most of the precipitation in the winter is snow on frozen ground. Average precipitation for LRU 01 Subset C is 16 inches and the frost free period averages 75 days. Precipitation is highest in May and June.

See Climatic Data Sheet for more details (Section II of the Field Office Technical Guide:

http://efotg.nrcs.usda.gov/efotg_locator.aspx?map=MT) or reference the following climatic web site:

<http://www.wrcc.dri.edu/climsum.html>

Table 3. Representative climatic features

Frost-free period (characteristic range)	63-85 days
Freeze-free period (characteristic range)	113-120 days
Precipitation total (characteristic range)	15-18 in
Frost-free period (actual range)	53-107 days
Freeze-free period (actual range)	100-135 days
Precipitation total (actual range)	14-19 in
Frost-free period (average)	76 days
Freeze-free period (average)	116 days
Precipitation total (average)	16 in

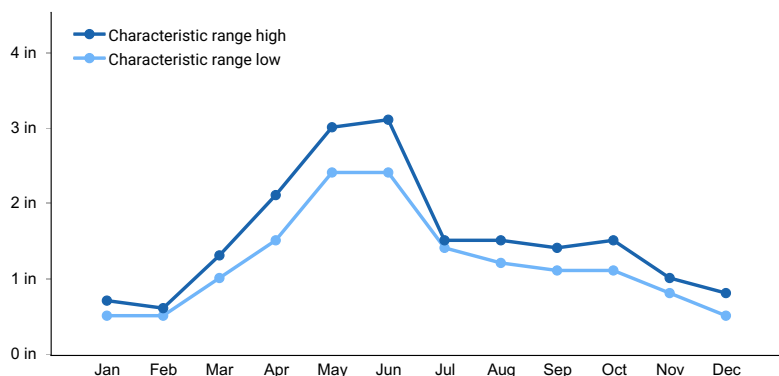

Figure 1. Monthly precipitation range

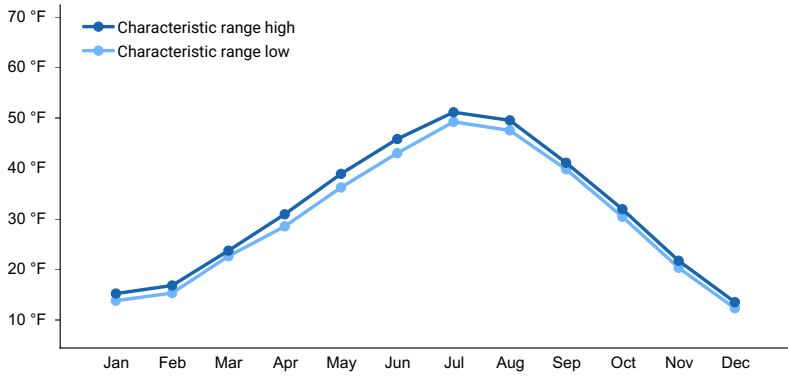

Figure 2. Monthly minimum temperature range

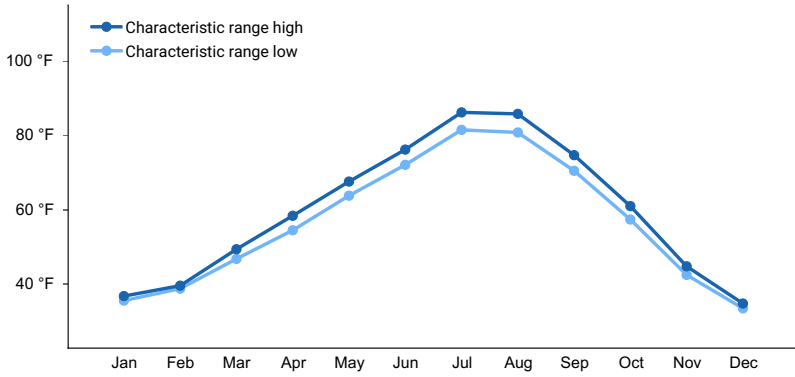

Figure 3. Monthly maximum temperature range

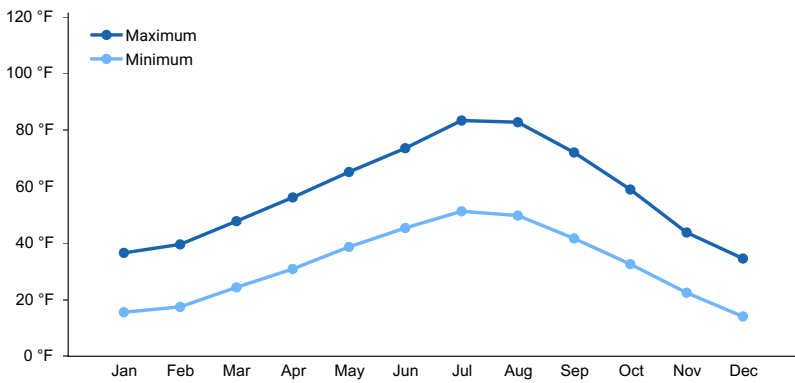

Figure 4. Monthly average minimum and maximum temperature

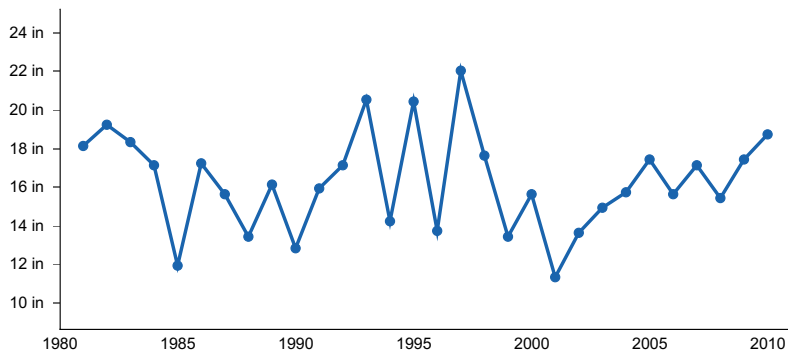

Figure 5. Annual precipitation pattern

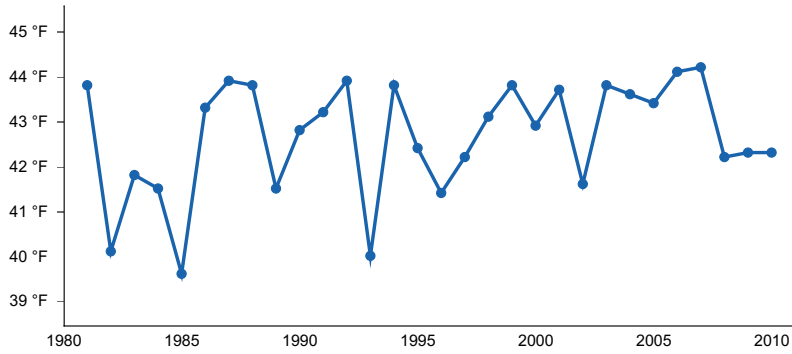

Figure 6. Annual average temperature pattern

Climate stations used

- (1) ANACONDA [USC00240199], Anaconda, MT
- (2) BOZEMAN MONTANA ST U [USC00241044], Bozeman, MT
- (3) NORRIS MADISON PH [USC00246157], Ennis, MT
- (4) PONY [USC00246655], Cardwell, MT
- (5) VIRGINIA CITY [USC00248597], Virginia City, MT
- (6) BOZEMAN GALLATIN FLD [USW00024132], Belgrade, MT
- (7) BOZEMAN 6 W EXP FARM [USC00241047], Bozeman, MT

Influencing water features

N/A

Wetland description

Site not associated with wetland

Soil features

These soils are moderately deep to very deep, moderately slow to moderate permeability, and are well drained. These Mollisols are formed from alluvium of mixed geologic origin. Typically soil surface textures consist of loam and silt loam textures. Clay content will be less than 32 percent in the surface mineral 4 inches (10cm) and, if present, an argillic horizon with less than 35 percent clay. Soils may have a gravelly surface and will vary based on its association with to a neighboring droughty site. Common soils series in this Ecological Site includes BigHole, Philipsburg, and Martinsdale. These soils may exist across multiple ecological sites due to natural variations in slope, surface texture, rock fragments, and pH. An onsite soils pit and most current Ecological Site Key are required to classify an ecological site.

Table 4. Representative soil features

Parent material	(1) Alluvium–igneous, metamorphic and sedimentary rock
Surface texture	(1) Loam (2) Silt loam
Family particle size	(1) Fine-loamy
Drainage class	Well drained
Permeability class	Moderately slow to moderate
Surface fragment cover <=3"	0–15%
Surface fragment cover >3"	0–15%
Available water capacity (0-40in)	4.6–8.7 in

Clay content (0-6in)	16–26%
Soil reaction (1:1 water) (0-10in)	6.6–7.8
Subsurface fragment volume <=3" (10-20in)	0–20%
Subsurface fragment volume >3" (10-20in)	0–15%

Ecological dynamics

The Loamy (Lo) ecological site is characterized by the production and composition of the Reference Plant Community, which is defined by soils, precipitation, and the temperature regime influencing the site. In the Rocky Mountain valleys of Southwest Montana, MLRA 44B LRU 01 Subset C is found where an Ustic soil moisture regime. This area is typified by a cold, frigid (bordering on cryic) soil temperature regime which receives a yearly representative value of 15 to 19 inches of relative effective annual precipitation and between 70 to 90 consecutive frost-free days annually. The Loamy ecological site is characterized by being not strongly or violently effervescent in the top 4 inches (10cm) of the soil surface with slope less than 15 percent

The majority of precipitation comes from April through June. Primary growth typically occurs between early June and early July. Dominant plants are those that have adapted to these very short growing conditions.

As the Loamy Ecological Site in LRU 01 Subset C occurs across a relatively large landscape, slight variations within the plant community occur due to elevation, frost-free days, and relative effective annual precipitation. Rough fescue, for example, occupies most known combinations of elevation and climates however under a drier moisture regime it is often codominant with bluebunch wheatgrass.

The reference plant community is dominated by rough fescue (*Festuca campestris*) and Idaho fescue (*Festuca idahoensis*). Subdominant species may include bluebunch wheatgrass (*Pseudoroegneria spicata*), green needlegrass (*Nassella viridula*), lupine (*Lupinus* spp), mountain big sagebrush (*Artemisia tridentata* ssp vaseyana), and winterfat (*Krascheninnikovia lanata*). (Ross et al. 1973).

Shrub expansion may occur in response to overgrazing, drought, and/or if long-term suppression of fire exists. Shrub expansion by a variety of species, including, broom snakeweed (*Gutierrezia sarothrae*), fringed sagewort (*Artemisia frigida*), mountain big sagebrush (*Artemisia tridentata* ssp. vaseyana), rubber rabbitbrush (*Ericameria nauseosa*), green rabbitbrush (*Chrysothamnus viscidiflorus*), and plains prickly pear (*Opuntia polyacantha*) occur within this site as the mid-statured bunchgrasses decrease. Shrub dominance and grass loss is associated with soil erosion and ultimately thinning of the native soil surface. Subsequent loss of soil could lead to a Degraded State. All states could also lead to the Invaded State when there is a lack of weed prevention and control measures.

Historical records indicate, prior to the introduction of livestock (cattle and sheep) during the late 1800's, elk and bison grazed this ecological site. Due to the nomadic nature and herd structure of bison, areas that were grazed received periodic high intensity short duration grazing pressure. The gold boom in the 1860s brought the first herds of livestock overland from Texas, and homesteaders began settling the area. During this time cattle were the primary domestic grazers in the area. In the 1890s Montana sheep production began to increase (greater than 400 percent) and dominated the livestock industry until the 1930s. Since the 1930s cattle production has dominated the livestock industry in the region (Wyckoff and Hansen 2001).

Natural fire was a major ecological driver of this entire Ecological Site. Fire tended to restrict tree and sagebrush growth to small patches and promoted an herbaceous plant community. The natural fire return interval was highly variable of up to 100 years however it was likely shorter than 35 years (Arno and Gruell 1983). With the historically recent, since 1910, suppression of fire sagebrush and trees have increased significantly.

Coniferous tree encroachment has also been accelerated by a shift in c

Due to relatively neutral to slightly alkaline pH, friable structure, and low rock fragment content of the soil combined with gentle slopes; the potential for irrigated and dryland farming is high. Hay production has constituted the largest

replacement of native vegetation on this site with perennial, introduced grass species and legumes (e.g., alfalfa) being best adapted. This ecological site has also been converted to pastureland usually perennial grasses and legumes for grazing. Cropland, pastureland, and hayland are intensively managed with annual cultivation, annual harvesting, and/or frequent use of herbicides, pesticides, and commercial fertilizers to increase production. Where irrigation water is available, this site is highly productive.

In recent history, a large amount of this ecological site has been subdivided into small ranchettes and other housing developments for rapidly growing population; particularly in Gallatin County. This conversion is not discussed in the State-and-Transition Model as it is extremely challenging to predict potential impacts and pathways however this conversion does have an impact on potential plant communities, hydrology, and other resources.

Dense clubmoss (*Selaginella densa*), in general, is a minor component of Reference Community of the Loamy Ecological Site. The conditions that created large cover classes of clubmoss on this site point to a history of continuous (yearlong) or moderate spring grazing use (Sturm 1954). In some situations, the site could be old crop fields that have reverted back to rangeland. In this case, clubmoss is helping reduce erosion and increase site stability especially where livestock use is restricted (such as CRP). While dense clubmoss provides soil stability on sites it exists, anecdotal recounts suggest that it competes for the limited water resources into the upper soil profile which restricts plant available water however a study from Canada (Colberg and Romo 2003) in a similar climate on similar soils indicates that the correlation between reduced plant available water and clubmoss cover is negligible. The correlation between reduced plant production may simply be competition for space though quantitative evidence is unavailable. Dense patches of clubmoss may also inhibit seed contact with soil; reducing seedling recruitment.

Some of the major invasive species that can occur on this site include (but not limited to) spotted knapweed (*Centaurea stoebe*), leafy spurge (*Euphorbia esula*), cheatgrass (*Bromus tectorum*), field brome (*Bromus arevensis*), yellow toadflax (*Linaria vulgaris*), dandelion (*Taraxicum* spp), Kentucky bluegrass (*Poa pratensis*), smooth brome (*Bromus inermis*), and Ventenata (*Ventenata dubia*). Invasive weeds are beginning to have a high impact on this Ecological Site due to primarily human impacts of mismanaged grazing, recreation, and urban development.

Plant Communities and Transitions

A State and Transition Model for this Loamy ecological site is depicted below. Thorough descriptions of each state, transition, plant community, and pathway follow the model. This model is based on available experimental research, field data, field observations, and interpretations by experts. It is likely to change as knowledge increases.

The plant communities within the same ecological site will differ across the MLRA due to the naturally occurring variability in weather, soils, and aspect. The biological processes on this site are complex; therefore, representative values are presented in a land management context. The species lists are representative and are not botanical descriptions of all species occurring, or potentially occurring, on this site. They are intended to cover the core species and known range of conditions and responses.

Both percent species composition by weight and percent canopy cover are referenced in this document. Canopy cover drives the transitions between communities and states because of the influence of shade, interception of rainfall and competition for available water. Species composition by dry weight remains an important descriptor of the herbaceous community and of the community as a whole. Woody species are included in species composition for the site. Calculating similarity index requires use of species composition by dry weight.

This State and Transition Model (STM) includes only rangeland communities and states. The converted communities are described in the Ecological Dynamics of the Site section above.

Although there is considerable qualitative experience supporting the pathways and transitions within the State and Transition Model (STM), no quantitative information exists that specifically identifies threshold parameters between grassland types and invaded types in this ecological site. For information on STMs, see the following citations: Bestelmeyer et al. 2003, Bestelmeyer et al. 2004, Bestelmeyer and Brown 2005, Stringham et al. 2003.

State and transition model

Land uses

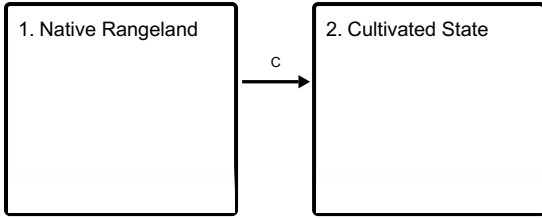

Land use 1 submodel, ecosystem states

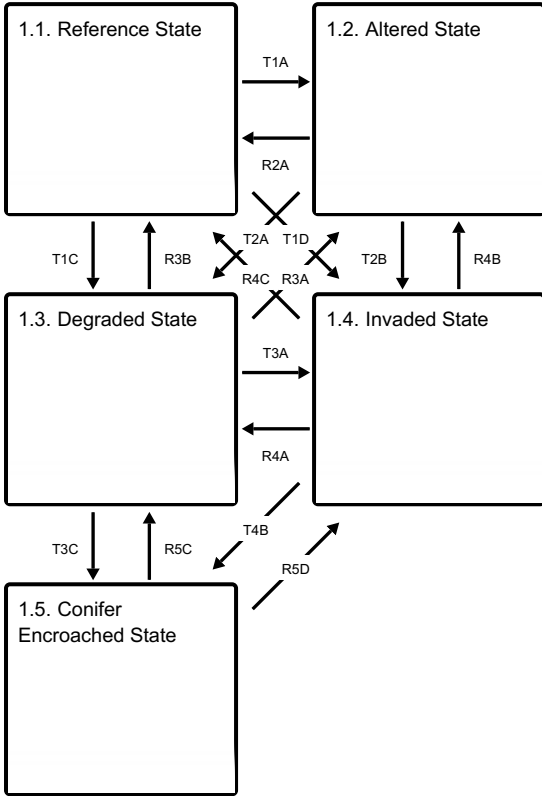

States 1, 5 and 2 (additional transitions)

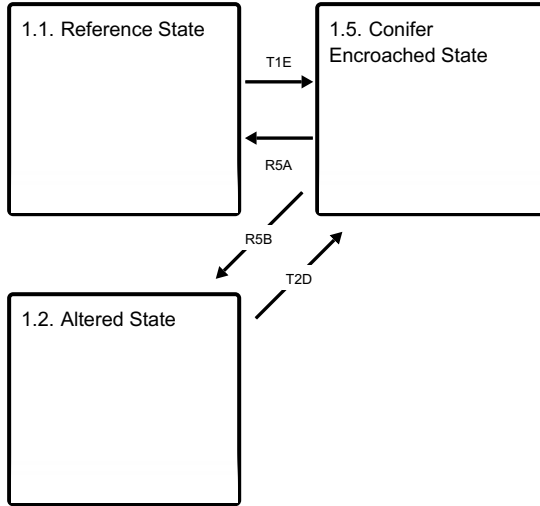

State 1 submodel, plant communities

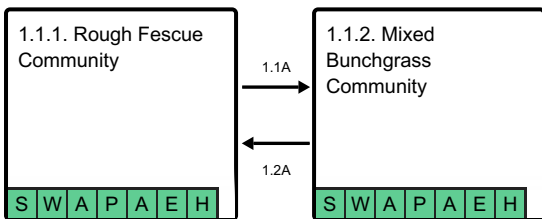

State 2 submodel, plant communities

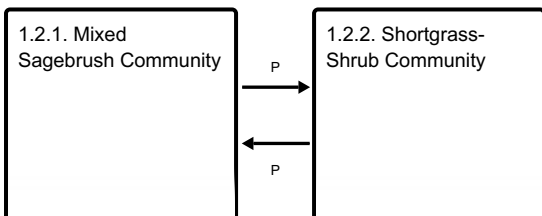

State 3 submodel, plant communities

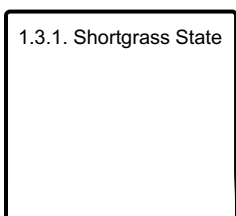

State 4 submodel, plant communities

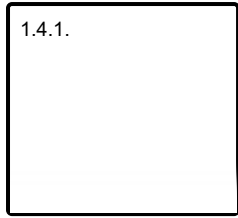

State 5 submodel, plant communities

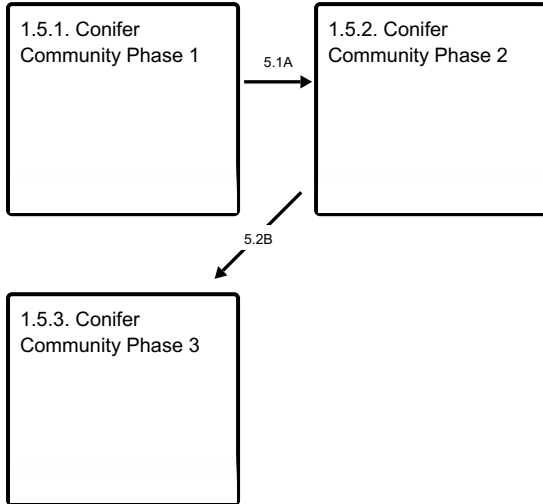

Land use 1

Native Rangeland

This land use, in MLRA 44B, is primarily native rangeland used for grazing of domestic livestock or for wildlife habitat.

State 1.1

Reference State

The Reference State of this ecological site consists of 2 known potential plant communities 1.1 Rough Fescue Community and 1.2 Mixed Bunchgrass Community. These are described below but are generally characterized by a mid-statured, cool season grass community with limited shrub production. Community 1.1 is dominated by rough fescue with subdominants of Idaho fescue and bluebunch wheatgrass. This community is considered the reference while Community 1.2 is a plant community codominated by rough fescue, bluebunch wheatgrass, and Idaho fescue with mountain big sagebrush as the dominant shrub.

Community 1.1.1

Rough Fescue Community

In the Rough Fescue Community, rough fescue (*Festuca scabrella*), Idaho fescue (*Festuca idahoensis*), bluebunch wheatgrass (*Pseudoroegneria spicata*), and Columbia needlegrass (*Acnatherum nelsonii*) are dominant. Basin wildrye (*Elymus cineris*), green needlegrass (*Nasella viridula*), and Cusick's bluegrass (*Poa cusickii*) will be subordinate grasses. Shrub species such as mountain big sagebrush (*Artemisia tridentata* ssp *vaseyana*), yellow rabbitbrush (*Chrysothamnus viscidiflorus*), and rubber rabbitbrush (*Ericameria nauseosa*) remain a minor part of the community. In areas where the soil texture is coarser, spineless horsebrush (*Tetradymia canescens*) may occupy a small niche. Sandberg bluegrass (*Poa secunda*) and dryland sedges may also be present. This community occurs on this Loamy site in areas with proper livestock grazing or in areas with little grazing use. Bluebunch wheatgrass and rough fescue lack resistance to grazing during the critical growing season and will decline in vigor and production if grazed in the critical growing season more than one year in three (Wilson et al. 1960). The critical growing period for bluebunch wheatgrass is late spring (June) while rough fescue is early summer (July). This community is moderately resilient and will return to dynamic equilibrium following a relatively short period of stress (such as drought or short-term improper grazing), provided a return of favorable or normal growing conditions, and properly managed grazing. Improper grazing is defined as grazing utilization that exceeds

moderate use (less than 50 percent grazing use) and/or multiple grazing events of a plant in the same growing season without rest. As discussed in the Ecological Dynamics section natural fire regime restricted shrubs to relatively small portions of the Rough Fescue Community 1.1. Shrub species not listed above may also include Wyoming big sagebrush (*Artemisia tridentata* ssp. *Wyomingensis*), shrubby cinquefoil (*Dasiphora fruticosa*), silver sagebrush (*Artemisia cana*), winterfat (*Krascheninnikovia lanata*), tarragon (*Artemisia drucunculus*), and fringed sagewort (*Artemisia frigida*).

Dominant plant species

- mountain big sagebrush (*Artemisia tridentata* ssp. *vaseyana*), shrub
- Wyoming big sagebrush (*Artemisia tridentata* ssp. *wyomingensis*), shrub
- spineless horsebrush (*Tetradymia canescens*), shrub
- yellow rabbitbrush (*Chrysothamnus viscidiflorus*), shrub
- rough fescue (*Festuca campestris*), grass
- Idaho fescue (*Festuca idahoensis*), grass
- bluebunch wheatgrass (*Pseudoroegneria spicata*), grass
- western wheatgrass (*Pascopyrum smithii*), grass
- lupine (*Lupinus*), other herbaceous
- common yarrow (*Achillea millefolium*), other herbaceous
- beardtongue (*Penstemon*), other herbaceous
- western stonecrop (*Lithospermum ruderale*), other herbaceous

Table 5. Annual production by plant type

Plant Type	Low (Lb/Acre)	Representative Value (Lb/Acre)	High (Lb/Acre)
Grass/Grasslike	1150	1400	1600
Forb	150	300	350
Shrub/Vine	150	300	350
Total	1450	2000	2300

Table 6. Ground cover

Tree foliar cover	0%
Shrub/vine/liana foliar cover	0-15%
Grass/grasslike foliar cover	35-50%
Forb foliar cover	5-15%
Non-vascular plants	0%
Biological crusts	0-3%
Litter	50-65%
Surface fragments >0.25" and <=3"	0-10%
Surface fragments >3"	0-5%
Bedrock	0%
Water	0%
Bare ground	0%

Table 7. Soil surface cover

Tree basal cover	0%
Shrub/vine/liana basal cover	0%
Grass/grasslike basal cover	0%
Forb basal cover	0%

Non-vascular plants	0%
Biological crusts	0%
Litter	0%
Surface fragments >0.25" and <=3"	0%
Surface fragments >3"	0%
Bedrock	0%
Water	0%
Bare ground	0-10%

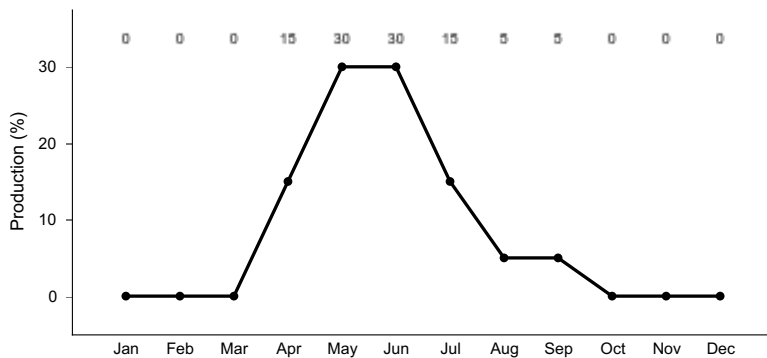

Figure 8. Plant community growth curve (percent production by month). MT44B032, Dry Uplands. Cool season grass dominated system. Most dry, upland sites located within MLRA 44B LRU A are characterized by early season growth which is mostly complete by Mid-July. Limited fall "green-up" if conditions allow..

Community 1.1.2 Mixed Bunchgrass Community

Idaho fescue tolerate grazing pressure better than bluebunch wheatgrass, rough fescue, and Columbia needlegrass. The growing points for bluebunch wheatgrass and rough fescue are several inches above the ground, making them very susceptible to continued close grazing (Smoliack, et al 2006), while Idaho fescue's growing point tend to be near the plant base. These grasses increases in species composition when more palatable and less grazing tolerant plants decrease due to overgrazing, drought, or intense fire. Idaho fescue, needle-and-thread, rough fescue, and bluebunch wheatgrass share dominance in the Mixed Bunchgrass Community (1.2). Other grass species, which are more tolerant to grazing and are likely to increase compared to the Rough Fescue Community, include Sandberg bluegrass (*Poa secunda*), prairie Junegrass, western/thickspike wheatgrass (*Pascopyrum smithii*, *Elymus lanceolatus*) and blue grama (*Bouteloua gracilis*). Some increaser forbs species include western yarrow, Hoods phlox (*Phlox hoodii*), scarlet globemallow (*Sphaeralcea coccinea*), hairy goldenaster (*Heterotheca villosa*), and pussytoes (*Antennaria* spp.). Fringed sagewort may also increase under prolonged drought or heavy grazing and can respond to precipitation that falls in July and August. Heavy, continuous grazing will reduce plant cover, litter, and soil organic matter. Timing of grazing is important on this site as grazing rough fescue in summer season has proven to negatively impact seasonal regeneration (Dormaar and Willms 1998), especially on the drier sites. Bare ground will increase and expose the soil to erosion. Litter and mulch will be reduced as plant cover declines. As long as the production of bluebunch wheatgrass and rough fescue are still a dominant species of total biomass production, the site can return to the Rough Fescue Community (Pathway 1.2A) under proper grazing management and favorable growing conditions. In this community, proper grazing management would be a grazing rotation that favors rough fescue. Such a grazing management plan would include conservative grazing with light grazing use during the critical growing season which is early to mid summer or preferably dormant grazing use. Dormant grazing use may be heavy as studies have shown rough fescue is tolerant to such utilization levels ((Johnston A and MacDonald 1967)(Willms et al. 1996)). Needle-and-thread and western wheatgrass will continue to increase until they make up the majority of species composition. Once rough fescue has been reduced to less than 30 percent by dry weight it may be difficult for the site to recover to Rough Fescue Community (1.1). The risk of soil erosion increases when canopy cover decreases. As soil conditions degrade, there will be loss of organic matter, reduced litter, and reduced soil fertility. Degraded soil conditions increase the difficulty of reestablishing bluebunch wheatgrass and rough fescue preventing the return to the Mid-Staturred Bunchgrass Community (1.1). The Mixed

Bunchgrass Community (1.2) is considered the At-Risk Plant Community for this ecological site. When overgrazing continues increases species such as needle-and-thread and native forb species will become more dominant and this triggers the change to the Altered State (2) or the Degraded State (3). Until the Mixed Bunchgrass Community (1.2) crosses the threshold into the Needle-and-thread Community (2.1) or the Invaded Community (4.1), this community can be managed toward the Rough Fescue Community (1.1) using prescribed grazing and strategic weed control. It may take several years to achieve this recovery, depending on growing conditions, vigor of remnant rough fescue plants, and the aggressiveness of the weed treatments (if necessary).

Dominant resource concerns

- Sheet and rill erosion
- Plant productivity and health
- Plant structure and composition
- Terrestrial habitat for wildlife and invertebrates

Pathway 1.1A

Community 1.1.1 to 1.1.2

Mid-statured bunchgrasses lose vigor with improper grazing (see definition below), extended drought, or unusually hot fire. When vigor declines enough for plants to die or become smaller, species with higher grazing tolerance (primarily Idaho fescue on this site) increase in vigor and production as they access the resources previously used by rough fescue and bluebunch wheatgrass. Decrease of these two species to less than 50 percent composition indicates that the plant community has shifted to the Mixed Bunchgrass Community (1.2). The driver for community shift 1.1A is improper grazing management or prolonged drought. This shift is triggered by the loss of vigor of rough fescue and bluebunch wheatgrass, soil erosion, or prolonged drought coupled with improper grazing. Blaisdell (1958) stated that drought and warmer than normal temperatures are known to advance plant phenology by as much as one month. During drought years, plants may be especially sensitive or in a critical stage of development earlier than expected. Since needle-and-thread normally heads out in June and bluebunch wheatgrass in July this should be taken into consideration when planning grazing management. Improper grazing on this ecological site is defined as grazing utilization that exceeds moderate use (less than 50 percent grazing use) and/or multiple grazing events of a plant in the same growing season without rest. Associated with grazing intensity is timing of grazing. Rough fescue's critical grazing period is early to mid summer however may be better suited to grazing events in the dormant period. Bluebunch wheatgrass is also susceptible to grazing during this time.

Pathway 1.2A

Community 1.1.2 to 1.1.1

The Mixed Bunchgrass Community (1.2) will return to the Rough Fescue Community (1.1) with proper grazing management and appropriate grazing intensity. Favorable moisture conditions will facilitate or accelerate this transition. It may take several years of favorable conditions for the community to transition back to a bluebunch dominated state. The driver for this community shift (1.2A) is increased vigor of bluebunch wheatgrass to the point that it represents more than 50 percent of species composition. The trigger for this shift is the change in grazing management favoring rough fescue and bluebunch wheatgrass. In general, conservative grazing management styles such as deferred or rest rotations utilizing moderate grazing (less than 50 percent grazing use) coupled with favorable growing conditions like cool, wet springs are these triggers. These systems tend to promote increases in soil organic matter which promotes microfauna and can increase infiltration rates. Inversely, long periods of rest at a time when this state is considered to be stable may not result in an increase in rough fescue nor bluebunch wheatgrass and it has been suggested (Noy-Meir 1975) that these long periods of rest or underutilization may actually drive the system to a lower level of stability by creating large amounts of standing biomass, dead plant caudex centers, and gaps in the plant canopy.

Conservation practices

Prescribed Burning
Prescribed Grazing

State 1.2

Altered State

This state is characterized by having less than 30 percent rough fescue and bluebunch wheatgrass by dry weight. It is represented by 2 communities that differ in the percent composition of Idaho fescue and needle-and-thread, overall production, and soil degradation. Production in this state can be similar to the Reference State (1). Some native plants tend to increase under prolonged drought and/or heavy grazing practices. A few of these species may include Idaho fescue, needle-and-thread, Sandberg bluegrass, scarlet globemallow, hairy goldenaster, and fringed sagewort.

Community 1.2.1 Mixed Sagebrush Community

Long-term grazing mismanagement with continuous growing-season pressure will reduce total productivity of the site and lead to an increase of bare ground. Suppression of fire can also promote shrub growth, increasing plant interspaces. Once plant cover is reduced, the site is more susceptible to erosion and degradation of soil properties. Soil erosion or reduced soil fertility will result in reduced plant production. This soil erosion or loss of soil fertility indicates the transition to the Altered State (2), because it creates a threshold requiring input of energy to return to the Reference State (1). Transition to the Mixed Sagebrush Community Community (2.1) may be exacerbated by extended drought conditions. Needle-and-thread and Idaho fescue dominate this Mixed Sagebrush Community (2.1). Bluebunch wheatgrass and rough fescue make up less than 30 percent of species composition by dry weight and the remaining mid-statured bunchgrasses plants tend to be scattered and low in vigor. Increaser and invader species will be more common. Increaser forb species include hairy goldenaster, Missouri goldenrod, stonecrop, lupine, and yarrow. It is not uncommon for a minor component of invader species such as dandelion and goatsbeard to be present. This creates more competition for bluebunch wheatgrass and rough fescue making it difficult for them to quickly respond to a change in grazing management alone. Therefore, an input of energy is required for the community to return to the Reference State (1). Wind and water erosion may be eroding soil from the plant interspaces. Soil fertility is reduced and soil surface erosion resistance has declined compared to the Reference State (1). Wyoming big sagebrush steppe communities historically had low fuel loadings and were characterized by 10- to 70-year interval, fires that produced a mosaic of burned and unburned lands (Bunting, et.al. 1987). Following fire on the fine-textured soils, the perennial bunchgrasses recovered in a few years and were present to fuel a subsequent fire. Conversely, extensive wildfires burning under hot-dry conditions would have resulted in nearly complete destruction of scattered sagebrush (Arno and Gruell 1983). Winterfat is tolerant of low intensity fire but will kill with a hot fire (Pellant 1984). This community crossed a threshold compared to the Mixed Bunchgrass Community (1.2) due to the erosion of soil, vegetation composition, loss of soil fertility, or degradation of soil conditions. This results in a critical shift in the ecology of the site. The effects of soil erosion can alter the hydrology, soil chemistry, soil microorganisms, and soil structure to the point where intensive restoration is required to restore the site to another state or community. Changing grazing management alone cannot create sufficient improvement to restore the site within a reasonable time frame. Dormaar (1997) stated that with decreased grazing pressure a needle-and-thread/blue grama plant community did not change species composition but the content of the soil carbon increased. It will require a considerable input of energy to move the site back to the Reference State (1). This state has lost soil or vegetation attributes to the point that recovery to the Reference State (1) will require reclamation efforts, i.e., soil rebuilding, intensive mechanical treatments, and/or reseeding. The transition to this state could result from overgrazing and fire suppression, especially repeated early season grazing coupled with extensive drought. If heavy grazing continues, plant cover, litter, and mulch will continue to decrease and bare ground will increase exposing the soil to accelerated erosion. Litter and mulch will move off-site as plant cover declines. The Mixed Sagebrush Community will then shift to a Shortgrass-Shrub Community (2.2). Continued improper grazing will drive the community to a Degraded State (3). Introduction or expansion of invasive species will further drive the plant community to the Invaded State (4).

Community 1.2.2 Shortgrass-Shrub Community

With continued mismanagement of grazing, especially coupled with prolonged drought, Idaho fescue, needle-and-thread and Letterman's needleggrass will decrease in vigor. The bunchgrasses will decline in production as plants die or become smaller, and species with higher grazing tolerance (such as western wheatgrass) increase in vigor and production as they respond to resources previously used by the bunchgrasses. These less desirable, shorter rooted species will become co-dominant with the bunchgrasses. Shrubs will become more competitive for limited moisture as bare ground and soil erosion increase. This state may exhibit conditions where livestock is consuming

shrubs.

Pathway P

Community 1.2.1 to 1.2.2

Pathway P

Community 1.2.2 to 1.2.1

State 1.3

Degraded State

Degraded State lacks midstatured bunchgrasses. Idaho fescue, Sandberg bluegrass and prairie Junegrass are dominant grasses. Increaser shrubs nearly replace larger shrub species. Remaining larger shrub species heavily hedged. This state is likely a terminal state (eg restoration will likely be impossible or unsuccessful without major energy inputs).

Community 1.3.1

Shortgrass State

Soil loss continues and subsequent loss of soil organic matter create conditions where native perennial grasses are reduced to less than 50 percent total production. Grass and forb cover may be sparse with obvious rill erosion between plant bases. Needle-and-thread and Idaho fescue exist in small patches. This could occur due to overgrazing (failure to adjust stocking rate to declining forage production due to increased invasive dominance), long-term lack of fire (if Wyoming big sagebrush occurs), or introduction of invasive species. In the most severe stages of degradation, there is a significant amount of bare ground, and large gaps occur between plants. Potential exists for soils to erode to the point that irreversible damage may occur. This is a critical shift in the ecology of the site. Soil erosion combined with lack of organic matter deposition due to sparse vegetation create changes to the hydrology, soil chemistry, soil microorganisms, and soil structure to the point where intensive restoration is required to restore the site to another state or community. Changing management (i.e., improving grazing management) cannot create sufficient change to restore the site within a reasonable time frame. This state is characterized by soil surface degradation and little plant soil surface cover. The forb component changes to be dominated by spiny phlox (*Phlox hoodii*) and shrub canopy cover is usually greater than 20 percent. Big sagebrush is replaced with a dominant community of low sagebrush (*Artemisia arbuscula*), broom snakeweed, rubber rabbitbrush, fringed sagewort, and plains pricklypear cactus. This state has lost soil or vegetation attributes to the point that recovery to the Reference State will require extensive reclamation efforts, i.e. soil rebuilding, intensive mechanical treatments, and reseeding. Grazing management such as a rest rotation will not return this state to Reference without these reclamation efforts. This plant community may be in a terminal state that will not return to the reference state because of degraded soil conditions and loss of higher successional native plant species. Key factors of approach to transition: Decrease in grass canopy cover and production, increase of shrub canopy cover, increases in mean bare patch size, increases in soil crusting, decreases in cover of cryptobiotic crusts, decreases in soil aggregate stability, and/or evidence of erosion including water flow patterns and litter movement.

State 1.4

Invaded State

The Invaded State is identified by being in the exponential growth phase of invader abundance where control is a priority. Dominance (or relative dominance) of noxious/invasive species reduces species diversity, forage production, wildlife habitat, and site protection. A level of 20 percent invasive species composition by dry weight indicates the point that a substantial energy input will be required to create a shift to the grassland state (herbicide, mechanical treatment) even with a return to proper grazing management or favorable growing conditions. Prescriptive grazing that specifically focuses on grazing of the invasive plant can be used to manage invasive species. In some instances, carefully targeted grazing (sometimes in combination with other treatments) can reduce or maintain species composition of invasive species.

Community 1.4.1

State 1.5

Conifer Encroached State

Rocky Mountain juniper (*Juniperus scopulorum*), Douglas fir (*Pseudotsuga menziesii*), and/or ponderosa pine (*Pinus ponderosa*) encroachment is common on this ecological site and is generally focused in areas where the mountains of MLRA 44B transition quickly to MLRA 43B. Under the Reference State, conifers may exist on this site however this is limited to 1 tree per hectare and is considered a trace canopy cover. Conifer encroachment likely occurs in the late stages of the Altered State (see State-and-transition model) where there is an increase of bare ground due to a combination of factors. Fire suppression and improper grazing management are the two most common triggers. The exact conditions in which juniper begins to encroach vary however the trend points to a combination of 1 or more of the following: moderately heavy to heavy grazing, reduced (non-existent) fire frequency, increased atmospheric carbon, and generally warmer climate (compared to that of pre-settlement). When heavy grazing occurs areas in the plant canopy open allowing for seed dispersal by bird or overland flow via rills on neighboring sites. The effects of juniper encroachment are not immediately noticed however over time as juniper canopy increases; light and water interception increase which reduce opportunities for herbaceous plants. One paper (Barrett, 2007) suggests that for precipitation to penetrate the juniper canopy, events must be greater than 0.30 inches. Increase juniper canopy creates perching sites for predators which reduces site suitability for greater sage grouse. More information is needed on the full extent and impact of conifer encroachment on this plant communities for an approved Ecological Site Description. Studies (Miller et al 2000) based in a similar community to the Conifer Encroached communities of Montana suggest following a phased approach to characterize the stand. Not unlike the Western Juniper community discussed in Miller et al, these communities of Montana exhibit 3 different phases based, at this time, on qualitative information.

Community 1.5.1

Conifer Community Phase 1

Phase I (Early) is defined by actively expanding juniper cover with generally less than 5 percent canopy cover and the trees' limbs generally touch the ground. This early stage generally has not lost its hydrologic functions however herbaceous plant communities may show signs of reduced production and species richness. Control methods include mechanical removal and prescribed fire. Prescribed fire is still effective management in this phase as it still contains the necessary native plants for recovery. The tree canopy is also low enough that risk of a dangerously hot fire is reduced.

Community 1.5.2

Conifer Community Phase 2

Phase II (Mid Stage) is still actively expanding however canopy cover may reach up to 15 percent. Due to the more mature trees present, seed production is very high. This Mid Phase begins to highly restrict herbaceous and shrubby plant. Conifers tend to be codominant. Hydrology is departing from reference with rills becoming longer and in isolated areas erosional gullies may begin to form. Control methods of the Mid Stage should focus on mechanical treatment (chainsaw cutting or mastication) as there is a high risk of catastrophic and potentially hot, sterilizing fire. Post treatments of slash are currently being evaluated but typically include chipping, lop-and-scatter, and slash piling. Lop-and-scatter and slash pile treatments are often burned to remove excess woody debris. Qualitative assessments of these treatments suggests native bunchgrasses respond immediately in this stage and post treatment grazing management including 2 growing seasons of rest may be necessary.

Community 1.5.3

Conifer Community Phase 3

Phase III (Late stage) is where juniper cover exceed 20 percent and has slowed to resemble a forest condition. Lower limbs of trees begin to die and the shrub cover is nearly lost. Traveling through this community is increasingly difficult. Conifers become the dominant plant with herbaceous plant production greatly decreased. Bare ground increases and hydrologic function is nearly lost compared to a grass/shrub community. Late Stage Phase should focus more on restoration than control as the necessary plants will likely not be present to cross the threshold back to the Reference State. Site stability and hydrologic function are lacking in this phase so mechanical removal of conifer will be necessary and prescribed fire is not suggested. Grazing rest, post treatment, is important as remaining native grasses will be reduced in stature and will be susceptible to accidental overgrazing as livestock

will seek out these tender plants. After a rest period, light and brief grazing may help initiate tillering of bunchgrasses.

Pathway 5.1A **Community 1.5.1 to 1.5.2**

Over time Phase I community expands to increase in both height and width. The driver for this pathway is primarily lack of fire however heavy grazing (utilization that exceeds 50 percent) can help reduce herbaceous competition and expose soil for seed contact. Increase atmospheric carbon dioxide has also been shown to increase coniferous tree and shrub growth (Archer et al. 2017).

Pathway 5.2B **Community 1.5.2 to 1.5.3**

Over time Phase II community expands to increase in both height and width. The driver for this pathway is primarily lack of fire however heavy grazing (utilization that exceeds 50 percent) can help reduce herbaceous competition and expose soil for seed contact. Increase atmospheric carbon dioxide has also been shown to increase coniferous tree and shrub growth (Archer et al. 2017).

Transition T1A **State 1.1 to 1.2**

The Reference State (1) transitions to the Altered State (2) if rough fescue and bluebunch wheatgrass, by dry weight, decreases to below 30 percent or if bare ground cover is increases by 10 percent . The driver for this transition is loss of taller bunchgrasses, which creates open areas in the plant canopy with bare soil. Soil erosion results in decreased soil fertility, driving transitions to the Altered State. There are several other key factors signaling the approach of transition T1A: increases in soil physical crusting, decreases in cover of cryptogamic crusts, decreases in soil surface aggregate stability and/or evidence of erosion including water flow patterns, development of plant pedestals, and litter movement. The trigger for this transition is improper grazing management and/or long-term drought leading to a decrease in bluebunch wheatgrass and rough fescue composition to less than 30 percent and reduction in total plant canopy cover.

Transition T1C **State 1.1 to 1.3**

The Reference State (1) transitions to the Degraded State (3) when bluebunch wheatgrass and rough fescue are completely removed from the plant community. Idaho fescue and needle-and-thread are subdominant to short statured bunchgrasses such as Sandberg and Cussick's bluegrass. The trigger for this transition is loss of mid-statured bunchgrasses, which creates open spaces with bare soil. Soil erosion as a result of increased bare ground and shallow roots decreases soil fertility, driving transitions to the Degraded State. There are several other key factors signaling the approach of transition T1C: increases in soil physical crusting, decreases in cover of cryptogamic crusts, decreases in soil surface aggregate stability and/or evidence of erosion including rills, water flow patterns, development of plant pedestals, and litter movement. The driver for this transition is improper grazing management, intense or repeated fires, and/or heavy human disturbance. Rapid transition is generally realized where livestock are confined to small pastures for long periods of time such as feeding areas, horse pastures, and bull lots. Degradation may be so extreme that traditional restoration methods may not be successful and require extensive mechanical and financial inputs.

Transition T1D **State 1.1 to 1.4**

Healthy plant communities are most resistant to invasion however, sometimes regardless of grazing management, without some form of active weed management (chemical, mechanical, or biological control), the Reference State (1) can transition to the Invaded State (4) in the presence of aggressive invasive species such as spotted knapweed, leafy spurge, and cheatgrass. The Central Rocky Mountain Valleys tend to resist invasion of cheatgrass however recent dry climate cycles, repeated heavy grazing or intense human activities can open the interspaces of the bunchgrass community and allow for encroachment. Long-term stress conditions for native

species (e.g., overgrazing, drought, and fire) accelerate this transition. If populations of invasive species reach critical levels, the site transitions to the Invaded State. The trigger for this transition is the presence of aggressive invasive species. Species composition by dry weight of invasive species approaches 10 percent.

Transition T1E **State 1.1 to 1.5**

Conifer tree/shrub count exceeds 1 stem per acre. The trigger is the presence of seeds and/or other viable material of these tree species.

Restoration pathway R2A **State 1.2 to 1.1**

The Altered State (2) has lost soil or vegetation attributes to the point that recovery to the Reference State (1) will require reclamation efforts such as soil rebuilding, intensive mechanical and cultural treatments, and/or revegetation. Examples of mechanical treatment may be brush control while cultural treatments may include prescribed grazing, targeted brush browsing, or prescribed burning. Grazing practices that promote rough fescue is primarily light to moderate grazing during the critical season (late June through July) or fall and dormant season of moderate however heavy utilization may not have negative impacts (Dormaar and Willms 1998) though grazing should match the species composition of the site prior to exceeding moderate utilization. Low intensity prescribed fires to reduce competitive increaser plants such as needle-and-thread and Sandberg bluegrass. A low intensity fire will also reduce big sagebrush densities. In areas with potential of annual grass infestation, fire should be carefully planned or avoided. The drivers for this restoration pathway are reclamation efforts along with proper grazing management.

Conservation practices

Brush Management
Prescribed Burning
Fence
Livestock Pipeline
Prescribed Grazing
Grazing Land Mechanical Treatment
Range Planting

Transition T2A **State 1.2 to 1.3**

As improper grazing continues vigor of bunchgrasses will decrease, and the shorter grasses and shrubs will increase towards the Degraded State (3). Improper grazing management for this state can be defined as grazing events that exceed moderate grazing (40 to 50 percent grazing use), grazing season that exceeds half of the growing season, and/or grazing events that consume the plant regrowth in the same growing season. Highly managed grazing events that exceed moderate grazing levels for short timeframes are generally not included in this definition due to increased rest periods between these grazing events. Additionally, prolonged drought will provide a competitive advantage to shrubs allowing them to become co-dominant with grasses. Shrub canopy will increase however shrubs will express low growth forms. Mat forming forbs will also increase. Key transition factors: increase of native shrub canopy cover; reduction in bunchgrass production; decrease in total plant canopy cover and production; increases in mean bare patch size; increases in soil crusting; decreases in cover of cryptobiotic crusts; decreases in soil aggregate stability; and/or evidence of erosion including water flow patterns and litter movement.

Transition T2B **State 1.2 to 1.4**

Invasive species can occupy the Altered State (2) and drive it to the Invaded State (4). The Altered State is at risk if invasive seeds and/or other viable material are present. The driver for this transition is more than 10 percent dry

weight of invasive species. The trigger is the presence of seeds and/or other viable material of invasive species.

Transition T2D **State 1.2 to 1.5**

Conifer tree/shrub cover exceeds 1 stem per acre. The trigger is the presence of seeds and/or other viable material of coniferous tree species.

Restoration pathway R3B **State 1.3 to 1.1**

The Degraded State (3) has lost soil or vegetation attributes to the point that recovery to the Reference State (1) will require reclamation efforts, such as soil rebuilding, intensive mechanical treatments, and/or revegetation. Studies suggest (Whitford et al 1989) a mulch with high carbon to nitrogen ratio such as wood chips or bark in low moisture scenarios can be beneficial for slow mobilization of plant available nitrogen. Biochar may also be added to the system to improve Soil Organic Carbon (SOC) which should improve Cation Exchange Capacity (CEC), microbial activity, and hydrologic conductivity (Stavi 2012). The drivers for the restoration pathway are removal of increaser species, restoration of native bunchgrass species, persistent management of invasives and shrubs, and proper grazing management. Without continued control, invasive and shrub species are likely to return (probably rapidly) due to presence of seeds and/or other viable material in the soil and management related increases soil disturbance.

Conservation practices

Brush Management
Prescribed Burning

Restoration pathway R3A **State 1.3 to 1.2**

Since the deep-rooted bunchgrass plant community has been removed, restoration to the Altered State (2) is unlikely unless a seed source is available. If a sufficient amount of bunchgrass remains on the site, chemical application and/or biological control in conjunction with proper grazing management, can reduce the amount of shrubs and invasive species and restore the site to the Shortgrass Community (2.2). Grazing management strategies that follow light grazing and allow for long periods of rest will allow for limited recovery of remaining bunchgrasses, however grazing management alone may not directly result in restoration. Restoration methods such as reseeding may be necessary. Low intensity fire can be utilized to reduce shrub competition and allow the reestablishment of grass species. Caution must be used when considering fire as a management tool on sites with fire tolerant shrubs such as rubber rabbitbrush, as these shrubs will re-sprout after a burn. Broom snakeweed and fringed sagewort may or may not re-sprout depending on conditions (USDA Forest Service 2011).

Transition T3A **State 1.3 to 1.4**

Invasive species can occupy the Degraded State (3) and drive it to the Invaded State (4). The Degraded State is at risk of this transition occurring if invasive seeds or viable material are present. The driver for this transition is presence of critical population levels of invasive species. The trigger is the presence of seeds or viable material of invasive species. This state has sufficient bare ground that the transition could occur simply due to presence or introduction of invasive seeds or viable material. This is particularly true of aggressive invasive species such as spotted knapweed and cheatgrass. This transition could be assisted by overgrazing (failure to adjust stocking rate to declining forage production), long-term lack of fire, or extensive drought.

Transition T3C **State 1.3 to 1.5**

Canopy cover of conifer tree/shrub cover exceeds 1 stem per acre. The trigger is the presence of seeds and/or other viable material of invasive species.

Restoration pathway R4C

State 1.4 to 1.1

Restoration of the Invaded State (4) to the Reference State (1) requires substantial energy input. The drivers for the restoration pathway are removal of invasive species, restoration of native bunchgrass species, persistent management of invasive species, and proper grazing management. Without continued control, invasive species are likely to return (probably rapidly) due to the presence of seeds and/or other viable material in the soil and management related practices that increase soil disturbance. If invaded by conifer encroachment, treatment depends on the condition of the rangeland. See Plant community 4.1 for alternative measures of restoration. Sites that have transitioned from the Degraded State (3) to the Invaded State (4) may be severely lacking soil and vegetative properties that will allow for restoration to the Reference State. Hydrologic function damage may be irreversible especially with accelerated gully erosion.

Restoration pathway R4B

State 1.4 to 1.2

If invasive species are removed before remnant populations of bunchgrasses have been drastically reduced the Invaded State (4) can return to the Altered State. The driver for the reclamation pathway is weed management without reseeding. Continued Integrated Pest Management (IPM) will be required as many of the invasive species that can occupy the Invaded State have extended dormant seed life. The trigger is invasive species control.

Restoration pathway R4A

State 1.4 to 1.3

If invasive species are removed the site could return to the Degraded State (3). Without sufficient remnant populations of preferred plants the Invaded State (4) is not likely to return to any of the other states. The driver for the reclamation pathway is weed management without reseeding. The trigger is invasive species control. The invading species cause a significant increased soil loss due to lack of ground cover (Lacey et al. 1989).

Transition T4B

State 1.4 to 1.5

Canopy cover of conifer tree/shrub cover exceeds 1 stem per acre. The trigger is the presence of seeds and/or other viable material of invasive species.

Restoration pathway R5A

State 1.5 to 1.1

Depending on the level of conifer canopy cover and its impact on rangeland health, restoration efforts may be simply focus on removal of coniferous trees and shrubs to restore the Conifer Encroached State (5) to the Reference State (1). If utilizing the phases established by Miller et al management and restoration methods will vary. A large majority of the conifer encroachment in MLRA 44B will fall into the early two phases of Miller's Phases. Phase I may exhibit None-Slight to Moderate departures from rangeland health where removal of the conifers via Brush Management and/or Prescribed fire combined. If mechanical removal of conifers is utilized, no grazing management is needed assuming relatively conservative management had been used prior to treatment. If prescribed fire is utilized, short term grazing deferment and/or rest is suggested. Given a short time removal of a Phase I encroachment will recover to Reference. Proactive pest management is encouraged. Phase II Encroachment may require a more intense mechanical removal of trees/shrubs with Prescribed Fire not being a feasible method of control as this community may be at risk of catastrophic fire due to canopy density. Phase II displays a Moderate departure from Reference suggesting an overall instability of the site such as reduced herbaceous production, reduced functional/structural groups (e.g. reduced mid-statured bunchgrasses), increase rill frequency and length, and possibly increased bare ground. Increased post treatment grazing management may be necessary. Grazing management may be as simple as short term growing season deferment however long term rest may be necessary in the latter stages of Phase II encroachment. Latter stages of Phase II encroachment will likely require some short term erosion mitigation such as straw wattles as well as range planting and/or critical area planting to re-establish any loss of native herbaceous plants particularly mid-statured cool season

bunchgrasses. Phase III Encroachment canopy cover resembles forested sites with larger trees and shrubs. Forest management style tree removal (woody debris and logs removed from the site) will be necessary prior to any prescribed burning as to prevent the fire from burning too hot. The result of a prescribed fire on this site are typically unknown as seed sources of native herbaceous plants are usually limited to small patches. Since herbaceous plants will likely have been depleted under a Phase III encroachment, there is an opportunity for large areas of bare ground, increase rill and in some cases gully erosion. Post treatment will require range planting and/or critical area seeding, erosion control, pest management, and possibly soil carbon amendments (biochar). Grazing management (primarily rest) will be necessary to ensure any new seedling establishment.

Restoration pathway R5B

State 1.5 to 1.2

The Conifer Encroached State (5) Phases I and II will generally resemble the Altered State (2) on this site. If utilizing the phases established by Miller et al management and restoration methods will vary. An large majority of the conifer encroachment in MLRA 44B will fall into the early two phases of Miller's Phases. Phase I may exhibit None-Slight to Moderate departures from rangeland health where removal of the conifers via Brush Management and/or Prescribed fire combined. If mechanical removal of conifers is utilized, no grazing management is needed assuming relatively conservative management had been used prior to treatment. If prescribed fire is utilized, short term grazing deferment and/or rest is suggested. Given a short time removal of a Phase I encroachment will recover to Reference. Proactive pest management is encouraged. Phase II Encroachment may require a more intense mechanical removal of trees/shrubs with Prescribed Fire not being a feasible method of control as this community may be at risk of catastrophic fire due to canopy density. Phase II displays a Moderate departure from Reference suggesting an overall instability of the site such as reduced herbaceous production, reduced functional/structural groups (e.g. reduced mid-statured bunchgrasses), increase rill frequency and length, and possibly increased bare ground. Increased post treatment grazing management may be necessary. Grazing management may be as simple as short term growing season deferment however long term rest may be necessary in the latter stages of Phase II encroachment. Latter stages of Phase II encroachment will likely require some short term erosion mitigation such as straw wattles as well as range planting and/or critical area planting to re-establish any loss of native herbaceous plants particularly mid-statured cool season bunchgrasses. Phase III Encroachment canopy cover resembles forested sites with larger trees and shrubs. Forest management style tree removal (woody debris and logs removed from the site) will be necessary prior to any prescribed burning as to prevent the fire from burning too hot. The result of a prescribed fire on this site are typically unknown as seed sources of native herbaceous plants are usually limited to small patches. Since herbaceous plants will likely have been depleted under a Phase III encroachment, there is an opportunity for large areas of bare ground, increase rill and in some cases gully erosion. Post treatment will require range planting and/or critical area seeding, erosion control, pest management, and possibly soil carbon amendments (biochar). Grazing management (primarily rest) will be necessary to ensure any new seedling establishment.

Restoration pathway R5C

State 1.5 to 1.3

The Conifer Encroached State (5) Phases II and III will likely resemble the Degraded State (3) on this site due to reduced midstatured bunchgrasses. If utilizing the phases established by Miller et al management and restoration methods will vary. An large majority of the conifer encroachment in MLRA 44B will fall into the early two phases of Miller's Phases. This Restoration Pathway is exceedingly rare as it is typically not cost effect for land managers to manage for a degraded state. Phase I may exhibit None-Slight to Moderate departures from rangeland health where removal of the conifers via Brush Management and/or Prescribed fire combined. If mechanical removal of conifers is utilized, no grazing management is needed assuming relatively conservative management had been used prior to treatment. If prescribed fire is utilized, short term grazing deferment and/or rest is suggested. Given a short time removal of a Phase I encroachment will recover to Reference. Proactive pest management is encouraged. Phase II Encroachment may require a more intense mechanical removal of trees/shrubs with Prescribed Fire not being a feasible method of control as this community may be at risk of catastrophic fire due to canopy density. Phase II displays a Moderate departure from Reference suggesting an overall instability of the site such as reduced herbaceous production, reduced functional/structural groups (e.g. reduced mid-statured bunchgrasses), increase rill frequency and length, and possibly increased bare ground. Increased post treatment grazing management may be necessary. Grazing management may be as simple as short term growing season deferment however long term rest may be necessary in the latter stages of Phase II encroachment. Latter stages of Phase II encroachment will likely require some short term erosion mitigation such as straw wattles as well as

range planting and/or critical area planting to re-establish any loss of native herbaceous plants particularly mid-statured cool season bunchgrasses. Phase III Encroachment canopy cover resembles forested sites with larger trees and shrubs. Forest management style tree removal (woody debris and logs removed from the site) will be necessary prior to any prescribed burning as to prevent the fire from burning too hot. The result of a prescribed fire on this site are typically unknown as seed sources of native herbaceous plants are usually limited to small patches. Since herbaceous plants will likely have been depleted under a Phase III encroachment, there is an opportunity for large areas of bare ground, increase rill and in some cases gully erosion. Post treatment will require range planting and/or critical area seeding, erosion control, pest management, and possibly soil carbon amendments (biochar). Grazing management (primarily rest) will be necessary to ensure any new seedling establishment.

Restoration pathway R5D State 1.5 to 1.4

If utilizing the phases established by Miller et al management and restoration methods will vary. An large majority of the conifer encroachment in MLRA 44B will fall into the early two phases of Miller's Phases. This Restoration Pathway is exceedingly rare as it is typically not cost effect for land managers to manage for a degraded state. Phase I may exhibit None-Slight to Moderate departures from rangeland health where removal of the conifers via Brush Management and/or Prescribed fire combined. If mechanical removal of conifers is utilized, no grazing management is needed assuming relatively conservative management had been used prior to treatment. If prescribed fire is utilized, short term grazing deferment and/or rest is suggested. Given a short time removal of a Phase I encroachment will recover to Reference. Proactive pest management is encouraged. Phase II Encroachment may require a more intense mechanical removal of trees/shrubs with Prescribed Fire not being a feasible method of control as this community may be at risk of catastrophic fire due to canopy density. Phase II displays a Moderate departure from Reference suggesting an overall instability of the site such as reduced herbaceous production, reduced functional/structural groups (e.g. reduced mid-statured bunchgrasses), increase rill frequency and length, and possibly increased bare ground. Increased post treatment grazing management may be necessary. Grazing management may be as simple as short term growing season deferment however long term rest may be necessary in the latter stages of Phase II encroachment. Latter stages of Phase II encroachment will likely require some short term erosion mitigation such as straw waddles as well as range planting and/or critical area planting to re-establish any loss of native herbaceous plants particularly mid-statured cool season bunchgrasses. Phase III Encroachment canopy cover resembles forested sites with larger trees and shrubs. Forest management style tree removal (woody debris and logs removed from the site) will be necessary prior to any prescribed burning as to prevent the fire from burning too hot. The result of a prescribed fire on this site are typically unknown as seed sources of native herbaceous plants are usually limited to small patches. Since herbaceous plants will likely have been depleted under a Phase III encroachment, there is an opportunity for large areas of bare ground, increase rill and in some cases gully erosion. Post treatment will require range planting and/or critical area seeding, erosion control, pest management, and possibly soil carbon amendments (biochar). Grazing management (primarily rest) will be necessary to ensure any new seedling establishment.

Land use 2 Cultivated State

Native rangeland is converted to a Cultivated system dominated on introduced species for forage or grain production. This system often receives multiple inputs including fertilizer, herbicides, and irrigation.

Conversion C Land use 1 to 2

Additional community tables

Table 8. Community 1.1 plant community composition

Group	Common Name	Symbol	Scientific Name	Annual Production (Lb/Acre)	Foliar Cover (%)
Grass/Grasslike					
1	Midstatured Bunchgrasses			980–1260	
	rough fescue	FECA4	<i>Festuca campestris</i>	900–1150	15–45
	bluestem	BOCP6	<i>Desmodium illinoense</i>	60–150	5–15

	bluebunch wheatgrass	PSSP6	<i>Pseudoroegneria spicata</i>	60-150	5-15
	Columbia needlegrass	ACNE9	<i>Achnatherum nelsonii</i>	10-100	3-5
	basin wildrye	LECI4	<i>Leymus cinereus</i>	0-100	0-5
	Letterman's needlegrass	ACLE9	<i>Achnatherum lettermanii</i>	0-60	0-2
	green needlegrass	NAVI4	<i>Nassella viridula</i>	0-40	1-5
2	Increaser Bunchgrasses and sedges			70-210	
	Idaho fescue	FEID	<i>Festuca idahoensis</i>	0-200	5-10
	needle and thread	HECO26	<i>Hesperostipa comata</i>	0-60	1-5
	Sandberg bluegrass	POSE	<i>Poa secunda</i>	10-60	0-3
	threadleaf sedge	CAFI	<i>Carex filifolia</i>	0-60	0-3
	prairie Junegrass	KOMA	<i>Koeleria macrantha</i>	20-40	1-2
	Cusick's bluegrass	POCU3	<i>Poa cusickii</i>	0-40	0-2
	needleleaf sedge	CADU6	<i>Carex duriuscula</i>	10-20	0-1
3	Rhizomatous Grasses			70-140	
	western wheatgrass	PASM	<i>Pascopyrum smithii</i>	40-140	0-2
	thickspike wheatgrass	ELLA3	<i>Elymus lanceolatus</i>	40-140	0-2
	plains reedgrass	CAMO	<i>Calamagrostis montanensis</i>	0-80	0-1
Forb					
4	Forbs			270-325	
	lupine	LUPIN	<i>Lupinus</i>	40-120	0-2
	dotted blazing star	LIPU	<i>Liatris punctata</i>	60-100	0-2
	American vetch	VIAM	<i>Vicia americana</i>	40-100	0-1
	scurfpea	PSORA2	<i>Psoraleidum</i>	0-80	0-1
	sulphur-flower buckwheat	ERUM	<i>Eriogonum umbellatum</i>	0-80	0-1
	common yarrow	ACMI2	<i>Achillea millefolium</i>	20-60	0-1
	western stoneseed	LIRU4	<i>Lithospermum ruderales</i>	20-60	0-1
	goldenbanner	THERM	<i>Thermopsis</i>	0-40	0-1
	beardtongue	PENST	<i>Penstemon</i>	20-40	0-1
	spiny phlox	PHHO	<i>Phlox hoodii</i>	0-20	0-1
	rosy pussytoes	ANRO2	<i>Antennaria rosea</i>	0-20	0-1
Shrub/Vine					
5	Shrubs			250-350	
	mountain big sagebrush	ARTRV	<i>Artemisia tridentata ssp. vaseyana</i>	100-225	5-15
	Wyoming big sagebrush	ARTRW8	<i>Artemisia tridentata ssp. wyomingensis</i>	0-120	0-5
	spineless horsebrush	TECA2	<i>Tetradymia canescens</i>	0-100	0-2
	common snowberry	SYAL	<i>Symphoricarpos albus</i>	0-80	0-1
	threetip sagebrush	ARTR4	<i>Artemisia tripartita</i>	0-60	0-2
	yellow rabbitbrush	CHVI8	<i>Chrysothamnus viscidiflorus</i>	0-60	0-1
	rubber rabbitbrush	ERNA10	<i>Ericameria nauseosa</i>	0-60	0-1
	shrubby cinquefoil	DAFR6	<i>Dasiphora fruticosa</i>	0-40	0-1
	Woods' rose	ROWO	<i>Rosa woodsii</i>	0-40	0-1
	broom snakeweed	GUSA2	<i>Gutierrezia sarothrae</i>	0-20	0-1

Animal community

The Loamy ecological site provides for a variety of wildlife habitat for an array of species. Prior to the settlement of this area, large herds of antelope, elk and bison roamed. Though the bison have been replaced, mostly with domesticated livestock; elk and antelope still frequently utilize this largely intact landscape for winter habitat in areas adjacent to forest.

The relatively high grass component of the Reference Community provides excellent nesting cover for multiple neotropical migratory birds that select for open grasslands such as the Long-billed curlew and McCown's longspur.

Greater sage grouse may be present on sites with suitable habitat, typically requiring a minimum of 15 percent sagebrush canopy cover (Wallestad 1975). The Rough Fescue Community (1.1) is likely to have this minimum sagebrush cover for sage grouse presence given its low to moderate sagebrush canopy cover. Also the potentially diverse forb component of the Reference State may provide the important early season (spring) foraging habitat for the Greater sage grouse. Other communities on the site with sufficient sagebrush cover may harbor sage grouse populations specifically Community 2.1 where big sagebrush populations increased under a reduced fire regime. Also as sagebrush canopy cover increases under Altered State (Plant Community 2.1 and 2.2) and, to a limited extent, the Degraded State (Plant Community 3.1); Pygmy rabbit, Brewer's sparrow, pronghorn antelope, and mule deer use may also increase.

Managed livestock grazing is suitable on this site due to the potential to produce an abundance of high quality forage. This is often a preferred site for grazing by livestock, and animals tend to congregate in these areas. In order to maintain the productivity of the Loamy site, grazing on adjoining sites with less production must be managed carefully to be sure utilization on this site is not excessive. Management objectives should include maintenance or improvement of the native plant community. Careful management of timing and duration of grazing is important. Shorter grazing periods and adequate deferment during the growing season are recommended for plant maintenance, health, and recovery. According to McLean et al, early season defoliation of bluebunch wheatgrass can result in high mortality and reduced vigor of plants. They also suggest, based on prior studies, that regrowth is necessary before dormancy to reduce injury of bluebunch.

Since Idaho fescue normally matures earlier than bluebunch wheatgrass and rough fescue this species is usually avoided after seed set. Changing grazing season of use will help utilize Idaho fescue more efficiently while preventing overuse of bluebunch wheatgrass and rough fescue.

Grazing season has more influence on winterfat than grazing intensity. Late winter or early spring grazing is detrimental. However, early winter grazing may actually be beneficial (Blaisdell 1984).

Continual non-prescribed grazing of this site will be detrimental, will alter the plant composition and production over time, and will result in transition to the Altered State. Transition to other states will depend on duration of poorly managed grazing as well as other circumstances such as weather conditions and fire frequency.

The Altered State is subject to further degradation to the Degraded State or Invaded State. Management should focus on grazing management strategies that will prevent further degradation, such as seasonal grazing deferment or winter grazing where feasible. Communities within this state are still stable and healthy under proper management. Forage quantity and/or quality may be substantially decreased from the Reference State.

Grazing is possible in the Invaded State. Invasive species are generally less palatable than native grasses. Forage production is typically greatly reduced in this state. Due to the aggressive nature of invasive species, sites in the Invaded State face increased risk for further degradation to the Invasive Dominated Communities. Grazing has to be carefully managed to avoid further soil loss and degradation and possible livestock health issues.

Prescriptive grazing can be used to manage invasive species. In some instances, carefully targeted grazing (sometimes in combination with other treatments) can reduce or maintain species composition of invasive species. In the Degraded State, grazing may be possible but is generally not economically and/or environmentally sustainable.

Hydrological functions

The hydrologic cycle functions best in the Reference State (1) with good infiltration and deep percolation of rainfall; however, the cycle degrades as the vegetation community declines. Rapid rainfall infiltration, high soil organic matter, good soil structure, and good porosity accompany high bunchgrass canopy cover. High ground cover reduces rain drop impact on the soil surface, which keeps erosion and sedimentation transport low. Water leaving the site will have minimal sediment load, which allows for high water quality in associated streams. High rates of infiltration will allow water to move below the rooting zone during periods of heavy rainfall. The Rough Fescue Community (1.1) should have no rills or gullies present and drainage ways should be vegetated and stable. Water flow patterns, if present, will be barely observable. Plant pedestals are essentially non-existent. Plant litter remains in place and is not moved by wind or water.

Improper grazing management results in a community shift to the Mixed Bunchgrass Community (1.2). This plant community has a similar canopy cover, but bare ground will be less than 15 percent. Therefore, the hydrologic cycle is functioning at a level similar to the water cycle in the Rough Fescue Community (1.1). Compared to the Rough Fescue Community (1.1) infiltration rates are slightly reduced and surface runoff is slightly higher.

In the Shortgrass Community (2.2), Degraded State (3) and the Invaded State (4) canopy and ground cover are greatly reduced compared to the Reference State (1), which impedes the hydrologic cycle. Infiltration will decrease and runoff will increase due to reduced ground cover, presence of shallow-rooted species, rainfall splash, soil capping, reduced organic matter, and poor structure. Sparse ground cover and decreased infiltration can combine to increase frequency and severity of flooding within a watershed. Soil erosion is accelerated, quality of surface runoff is poor, and sedimentation increases.

Hydrology of the Conifer Encroached State (5) is highly variable however studies suggest that increased tree canopy affects interception of rainfall and well as reduces available soil moisture for herbaceous vegetation. This can negatively affect infiltration and increase runoff.

Recreational uses

This site provides recreational opportunities for hiking, horseback riding, big game and upland bird hunting. Some forbs have flowers that appeal to photographers. This site provides valuable open space.

Inventory data references

Information presented was derived from the site's Range Site Description (Loamy 15-19 inch P.Z., Northern Rocky Mountain Valleys, South, East of Continental Divide), NRCS clipping data, literature, field observations, and personal contacts with range-trained personnel (i.e., used professional opinion of agency specialists, observations of land managers, and outside scientists).

References

- Archer, S.R., E.M. Andersen, K.I. Predick, S. Schwinning, R.J. Steidl, and S.R. Woods. 2017. *Woody Plant Encroachment: Causes and Consequences*. Springer International Publishing. 59p.
- Dormarr, J.F. and W.D. Willms. 1998. Effect of forty-four years of grazing on fescue grassland soils.. *Journal of Range Management* 51:122–126.
- Dormarr, J.F. and W.D. Willms. 1998. Effect of forty-four years of grazing on fescue grassland soils. *Journal of Range Management* 51:122–126.
- Johnston A and M.D. MacDonald. 1967. Foral Initiation and Seed Production in *Festuca Scabrella*. *Canadian Journal of Plan Science* 47:577–583.

Other references

2015. Montana Field Office Technical Guide.

2015. Fire Effects Information System. <http://www.fs.fed.us/database/feis/>.

2015 (Date accessed). USDA PLANTS Database. <http://plants.usda.gov>.

Arno, S.F. and G.E. Gruell. 1982. Fire History at the Forest-Grassland Ecotone in Southwestern Montana. *Journal of Range Management* 36:332–336.

Barrett, H. 2007. *Western Juniper Management: A Field Guide*.

Bestelmeyer, B., J.R. Brown, J.E. Herrick, D.A. Trujillo, and K.M. Havstad. 2004. Land Management in the American Southwest: a state-and-transition approach to ecosystem complexity. *Environmental Management* 34:38–51.

Bestelmeyer, B. and J. Brown. 2005. State-and-Transition Models 101: A Fresh look at vegetation change.

Blaisdell, J.P. 1958. Seasonal development and yield of native plants on the Upper Snake River Plains and their relation to certain climate factors.

Blaisdell, J.P. and R.C. Holmgren. 1984. *Managing Intermountain Rangelands--Salt-Desert Shrub Ranges*. General Tech Report INT-163. USDA Forest Service, Intermountain Forest and Range Experiment Station, Ogden, UT. 52.

Bunting, S.C., B.M. Kilgore, and C.L. Bushey. 1987. *Guidelines for Prescribe burning sagebrush-grass rangelands in the Northern Great Basin*. General Technical Report INT-231. USDA Forest Service Intermountain Research Station, Ogden, UT. 33.

Colberg, T.J. and J.T. Romo. 2003. Clubmoss effects on plant water status and standing crop. *Journal of Range Management* 56:489–495.

Daubenmire, R. 1970. *Steppe vegetation of Washington*.

DiTomaso, J.M. 2000. Invasive weeds in Rangelands: Species, Impacts, and Management. *Weed Science* 48:255–265.

Dormaar, J.F., B.W. Adams, and W.D. Willms. 1997. Impacts of rotational grazing on mixed prairie soils and vegetation. *Journal of Range Management* 50:647–651.

Hobbs, J.R. and S.E. Humphries. 1995. An integrated approach to the ecology and management of plant invasions. *Conservation Biology* 9:761–770.

Kuchler, A.W. 1964. *Potential natural vegetation of the conterminous United States*.

Lacey, J.R., C.B. Marlow, and J.R. Lane. 1989. Influence of Spotted knapweed (*Centaurea maculosa*) on surface runoff and sediment yield.. *Weed Technology* 3:627–630.

Lesica, P. and S.V. Cooper. 1997. *Presettlement vegetation of Southern Beaverhead County, MT*.

Manske, L.L. 1980. *Habitat, phenology, and growth of selected sandhills range plants*.

Masters, R. and R. Sheley. 2001. Principles and practices for managing rangeland invasive plants. *Journal of Range Management* 38:21–26.

McCalla, G.R., W.H. Blackburn, and L.B. Merrill. 1984. Effects of Livestock Grazing on Infiltration Rates of the Edwards Plateau of Texas. *Journal of Range Management* 37:265–269.

- McLean, A. and S. Wikeem. 1985. Influence of season and intensity of defoliation on bluebunch wheatgrass survival and vigor in southern British Columbia. *Journal of Range Management* 38:21–26.
- Miller, R.F., T.J. Svejcar, and J.A. Rose. 2000. Impacts of western juniper on plant community composition and structure. *Journal of Range Management* 53:574–585.
- Moulton, G.E. and T.W. Dunlay. 1988. *The Journals of the Lewis and Clark Expedition*. Pages in University of Nebraska Press.
- Mueggler, W.F. and W.L. Stewart. 1980. Grassland and shrubland habitat types of Western Montana.
- Pelant, M., P. Shaver, D.A. Pyke, and J.E. Herrick. 2005. Interpreting Indicators of Rangeland Health.
- Pellant, M. and L. Reichert. 1984. Management and Rehabilitation of a burned winterfat community in Southwestern Idaho. Proceedings--Symposium on the biology of Atriplex and related Chenopods. 1983 May 2-6; Provo UT General Technical Report INT-172.. USDA Forest Service Intermountain Forest and Range Experiment Station. 281–285.
- Pitt, M.D. and B.M. Wikeem. 1990. Phenological patterns and adaptations in an Artemisia/Agropyron plant community. *Journal of Range Management* 43:350–357.
- Pokorny, M.L., R. Sheley, C.A. Zabinski, R. Engel, T.J. Svejcar, and J.J. Borkowski. 2005. Plant Functional Group Diversity as a Mechanism for Invasion Resistance.
- Wambolt, C. and G. Payne. 1986. An 18-Year Comparison of Control Methods for Wyoming Big Sagebrush in Southwestern Montana. *Journal of Range Management* 39:314–319.
- West, N.E. 1994. Effects of Fire on Salt-Desert shrub rangelands. Proceedings--Ecology and Management of Annual Rangelands: 1992 May 18-22. Boise ID General Technical Report INT-GTR-313.. USDA Forest Service Intermountain Research Station. 71–74.
- Whitford, W.G., E.F. Aldon, D.W. Freckman, Y. Steinberger, and L.W. Parker. 1989. Effects of Organic Amendments on Soil Biota on a Degraded Rangeland. *Journal of Range Management* 41:56–60.
- Wilson, A.M., G.A. Harris, and D.H. Gates. 1966. Cumulative Effects of Clipping on Yield of Bluebunch wheatgrass. *Journal of Range Management* 19:90–91.

Contributors

Petersen
Synergy Resource Solutions
Ricketts
Gibbons
Walstad

Approval

Kirt Walstad, 9/07/2023

Rangeland health reference sheet

Interpreting Indicators of Rangeland Health is a qualitative assessment protocol used to determine ecosystem condition based on benchmark characteristics described in the Reference Sheet. A suite of 17 (or more) indicators are typically considered in an assessment. The ecological site(s) representative of an assessment location must be known prior to applying the protocol and must be verified based on soils and climate. Current plant community cannot be used to identify the ecological site.

Author(s)/participant(s)	Grant Petersen Kirt Walstad
Contact for lead author	grant.petersen@usda.gov 406-683-3804
Date	03/01/2020
Approved by	Kirt Walstad
Approval date	
Composition (Indicators 10 and 12) based on	Annual Production

Indicators

1. **Number and extent of rills:** Rills are not present in the reference condition.

2. **Presence of water flow patterns:** Water flow patterns are not present in the reference condition.

3. **Number and height of erosional pedestals or terracettes:** Pedestals are not evident in the reference condition.

4. **Bare ground from Ecological Site Description or other studies (rock, litter, lichen, moss, plant canopy are not bare ground):** Bare ground is low (5-10 percent). It consists of small, randomly scattered patches.

5. **Number of gullies and erosion associated with gullies:** Gullies are not present in the reference condition.

6. **Extent of wind scoured, blowouts and/or depositional areas:** Wind scoured, or depositional areas are not evident in the reference condition.

7. **Amount of litter movement (describe size and distance expected to travel):** Litter movement is not evident in the reference condition.

8. **Soil surface (top few mm) resistance to erosion (stability values are averages - most sites will show a range of values):** The average soil stability rating is 5-6 under plant canopies and 4-6 plant interspaces. The A horizon is 6-8 inches thick.

9. **Soil surface structure and SOM content (include type of structure and A-horizon color and thickness):** Soil Structure at the surface is strong to medium fine granular. A Horizon should be 6-8 inches thick with color, when wet, typically ranging in Value of 3 or less and Chroma of 3 or less. Local geology may affect color in which it is important to reference the Official Series Description (OSD) for characteristic range.
<https://soilseries.sc.egov.usda.gov/osdname.aspx>

10. **Effect of community phase composition (relative proportion of different functional groups) and spatial distribution on infiltration and runoff:** Evenly distributed across the site, bunchgrasses improve infiltration while rhizomatous grass protects the surface from runoff forces. Infiltration of the Loamy ecological site is well drained but has a slow infiltration rate. An even distribution of mid stature grasses, (70-80% of site production), cool season rhizomatous grasses (5-10%), shortgrasses (10-15%), forbs (5-10%), shrubs (5-10%), and subshrubs (1-5%).
-
11. **Presence and thickness of compaction layer (usually none; describe soil profile features which may be mistaken for compaction on this site):** A compaction layer is not present in the reference condition. Soil profile may contain an abrupt transition to an Argillic horizon which can be misinterpreted as compaction, however, the soil structure will be fine to medium subangular blocky, where a compaction layer will be platy or structureless (massive).
-
12. **Functional/Structural Groups (list in order of descending dominance by above-ground annual-production or live foliar cover using symbols: >>, >, = to indicate much greater than, greater than, and equal to):**
- Dominant: Dominant: Mid-statured, cool season, perennial bunchgrasses (rough fescue, bluebunch wheatgrass, basin wildrye)
- Sub-dominant: shortgrasses/grasslikes > shrubs = rhizomatous grasses ≥ forbs ≥ subshrubs
- Other:
- Additional:
-
13. **Amount of plant mortality and decadence (include which functional groups are expected to show mortality or decadence):** Mortality in herbaceous species is not evident. Species with bunch growth forms may have some natural mortality in centers is 3 percent or less.
-
14. **Average percent litter cover (%) and depth (in):** Total litter cover ranges from 50 to 65%. Most litter is irregularly distributed on the soil surface and is not at a measurable depth.
-
15. **Expected annual annual-production (this is TOTAL above-ground annual-production, not just forage annual-production):** Average annual production is 2000. Low: 1400 High 2200. Production varies based on effective precipitation and natural variability of soil properties for this ecological site.
-
16. **Potential invasive (including noxious) species (native and non-native). List species which BOTH characterize degraded states and have the potential to become a dominant or co-dominant species on the ecological site if their future establishment and growth is not actively controlled by management interventions. Species that become dominant for only one to several years (e.g., short-term response to drought or wildfire) are not invasive plants. Note that unlike other indicators, we are describing what is NOT expected in the reference state for the ecological site:** Potential invasive (including noxious) species (native and non-native). Invasive species on this ecological site include (but not limited to) dandelion, annual brome spp., spotted knapweed, yellow toadflax, leafy spurge, ventenata, crested wheatgrass, Kentucky bluegrass, smooth brome, meadow foxtail
- Native species such as Rocky Mountain juniper, ponderosa pine, Douglas fir, broom snakeweed, rabbitbrush spp., big sagebrush, blue grama, Sandberg's bluegrass, etc. when their populations are significant enough to affect ecological

function, indicate site condition departure.

17. **Perennial plant reproductive capability:** In the reference condition, all plants are vigorous enough for reproduction either by seed or rhizomes in order to balance natural mortality with species recruitment.
-