

## Ecological site F048AY912CO Lodgepole Pine

Last updated: 3/05/2024  
Accessed: 05/17/2024

---

### General information

**Provisional.** A provisional ecological site description has undergone quality control and quality assurance review. It contains a working state and transition model and enough information to identify the ecological site.

### MLRA notes

Major Land Resource Area (MLRA): 048A–Southern Rocky Mountains

MLRA 48A makes up about 45,920 square miles (119,000 square kilometers) and is the southern part of the Rocky Mountains. The Southern Rocky Mountains lies east of the Colorado Plateau, south of the Wyoming Basin, west of the Great Plains, and north of the Rio Grande Rift. It is in western and central Colorado, southeastern Wyoming, eastern Utah, and northern New Mexico. The headwaters of major rivers such as the Colorado, Yampa, Arkansas, Rio Grande, North Platte and South Plate rivers are located here. This MLRA has numerous national forests, including the Medicine Bow National Forest in Wyoming; the Routt, Arapaho, Roosevelt, Pike, San Isabel, White River, Gunnison, Grand Mesa, Uncompahgre, Rio Grande, and San Juan National Forests in Colorado; the Carson National Forest and part of the Santa Fe National Forest in New Mexico. Rocky Mountain National Park also is in this MLRA.

MLRA 48A is the southern Rocky Mountains physiographic region. The Southern Rocky Mountains consist primarily of two belts of strongly sloping to precipitous mountain ranges trending north to south. Several basins, or parks, are between the belts. Some high mesas and plateaus are included. It is characterized by mountain ranges that were uplifted during the Laramide Orogeny and then had periods of glaciation. The ranges include the Sangre de Cristo Mountains, the Laramie Mountains, and the Front Range in the east and the San Juan Mountains and the Sawatch and Park Ranges in the west. The ranges are dissected by many narrow stream valleys having steep gradients. In some areas the upper mountain slopes and broad crests are covered by snowfields and glaciers. Elevation typically ranges from 6,500 to 14,400 feet (1,980 to 4,390 meters) in this area. The part of this MLRA in central Colorado includes the highest point in the Rockies, Mount Elbert, which reaches an elevation of 14,433 feet (4,400 meters). More than 50 peaks in the part of the MLRA in Colorado are at an elevation of more than 14,000 feet (4,270 meters). Many small glacial lakes are in the high mountains.

The mountains in this area were formed mainly by crustal uplifts during the late Cretaceous and early Tertiary periods. This large MLRA can be subdivided into at least 4 large general divisions. First is the Rockies on the east side of this area are called the "Front Range," which is a fault block that has been tilted up on edge and uplifted and is largely igneous and metamorphic geology. It was tilted up on the east edge, so there is a steep front on the east and the west side is more gently sloping and in the south east there are rocks exposed in the mountains are mostly Precambrian igneous and metamorphic rocks. Second is the tertiary rocks, primarily basalt and andesitic lava flows, tuffs, breccias, and conglomerates, are throughout this area (San Juan Mountains Area). The third division is Northwest part of the MLRA is dominantly sedimentary rock from the cretaceous/tertiary and Permian/Pennsylvanian periods. The fourth subset is the long and narrow Sangre de Cristos mountains uplifted in the Cenozoic are between the Rio Grande rift and the great plains. Many of the highest mountain ranges were reshaped by glaciation during the Pleistocene. Alluvial fans at the base of the mountains are recharge zones for local basin and valley fill aquifers. They also are important sources of sand and gravel.

The average annual precipitation ranges predominantly from 12 to 63 inches. Summer rainfall commonly occurs as high-intensity, convective thunderstorms. About half of the annual precipitation occurs as snow in winter; this proportion increases with elevation. In the mountains, deep snowpacks accumulate throughout the winter and

generally persist into spring or early summer, depending on elevation. Some permanent snowfields and small glaciers are on the highest mountain peaks. In the valleys at the lower elevations, snowfall is lighter and snowpacks can be intermittent. The average annual temperature is 26 to 54 degrees F (-3 to 12 degrees C). The freeze-free period averages 135 days and ranges from 45 to 230 days, decreasing in length with elevation. The climate of this area is strongly dependent upon elevation; precipitation is greater, and temperatures are cooler at the higher elevations. The plant communities vary with elevation, aspect and change in latitudes due to changing in precipitation kind and timing and temperature.

The dominant soil orders in this MLRA are Mollisols, Alfisols, Inceptisols, and Entisols. The soils in the area dominantly have a frigid or cryic soil temperature regime and an ustic or udic soil moisture regime. Mineralogy is typically mixed, smectitic, or paramicaceous. In areas with granite, gneiss, and schist bedrock, Glossocryalfs (Seitz, Granile, and Leadville series) and Haplocryolls (Rogert series) formed in colluvium on mountain slopes. Dystrocryepts (Leighcan and Mummy series) formed on mountain slopes and summits at the higher elevations. In areas of andesite and rhyolite bedrock, Dystrocryepts (Endlich and Whitecross series) formed in colluvium on mountain slopes. In areas of sedimentary bedrock, Haplustolls (Towave series) formed on mountain slopes at low elevations and with low precipitation. Haplocryolls (Lamphier and Razorba series), Argicryolls (Cochetopa series), and Haplocryalfs (Needleton series) formed in colluvium on mountain slopes at high elevations.

### **Classification relationships**

#### **NRCS:**

Major Land Resource Area 48A, Southern Rocky Mountains (United States Department of Agriculture, Natural Resources Conservation Service, 2006).

#### **USFS:**

M331F- Southern Parks and Rocky Mountain Range Section Southern Rocky Mountain Steppe - Open Woodland - Coniferous Forest - Alpine Meadow

M331G – South Central Highlands Section Southern Rocky Mountain Steppe - Open Woodland - Coniferous Forest - Alpine Meadow

M331H – North Central Highlands and Rocky Mountains Section Southern Rocky Mountain Steppe - Open Woodland - Coniferous Forest - Alpine Meadow

M331I – North Parks and Ranges Section Southern Rocky Mountain Steppe - Open Woodland - Coniferous Forest - Alpine Meadow

M341B – Tavaputs Plateau Section M341 Nevada-Utah Mountains Semi-Desert - Coniferous Forest - Alpine Meadow (Cleland, et al., 2007).

#### **EPA:**

21a – Alpine Zone, 21b – Crystalline Subalpine Forests, 21c – Crystalline Mid-Elevations Forests, 21d -Foothill Shrublands, 21e – Sedimentary Subalpine Forests, 21f – Sedimentary Mid-Elevation Forests, 21g – Volcanic Subalpine Forests, and 21h – Volcanic Mid-Elevation Forests < 21 Southern Rockies < 6.2 Western Cordillera < 6 Northwestern Forested Mountains North American Deserts (Griffith, 2006).

20c – Semiarid Benchlands and Canyonlands and 20e - Escarpements < 20 Colorado Plateau < 10.1 Cold Deserts < 10 North American Deserts (Griffith, 2006).

#### **USGS:**

Southern Rocky Mountain Province and the southern part of Unita Basin Section Colorado Plateaus Province

### **Ecological site concept**

This site is found mostly commonly on mountain slopes. Soils are shallow to very deep (10 to 60+ inches). Soil surface textures are very gravelly loam, cobbly fine sandy loam or fine sandy loam. Subsurface textures can be loamy-skeletal or clayey-skeletal. It is usually ustic udic and cryic. . It is a Lodgepole pine – Common Juniper – Elk Sedge community. The effective precipitation ranges from 20 to 30 inches.

## Associated sites

F048AY918CO	<p><b>Spruce-Fir Woodland</b></p> <p>This site is found mostly commonly on mountain slopes, complex landslides, and mesas. Soils are moderately deep to very deep (20 to 60+ inches). Soil surface textures are loam, cobbly loam, gravelly loam, very cobbly sandy loam, very gravelly sandy loam, very stony sandy loam, very cobbly fine sandy loam, or stony fine sandy loam. Subsurface textures can be loamy-skeletal, or clayey-skeletal. It is usually ustic udic or typic udic and cryic. It is a Engelmann Spruce – Subalpine Fir – Elk Sedge – Slender Wheatgrass community. The effective precipitation ranges from 20 to 40 inches.</p>
R048AY241CO	<p><b>Mountain Meadow</b></p> <p>This site occurs flood plains, stream terraces, drainageways, ephemeral streams, flood-plain step and depressions. This site has natural sub-irrigation. Slopes is between 0 to 12%. Soils are moderately deep to very deep (20 to 60+ inches). Soils are derived from alluvium from sandstone and shale, sedimentary rock, igneous, metamorphic and sedimentary rock, or shale. Soil surface texture is loam, silty clay loam, clay loam, clay, sandy clay loam or sandy loam with fine-loamy or fine textured subsurface. It has a typic aquic or oxyaquic ustic moisture regime. The effective precipitation ranges from 16 to 20 inches.</p>

## Similar sites

F048AY918CO	<p><b>Spruce-Fir Woodland</b></p> <p>This site is found mostly commonly on mountain slopes, complex landslides, and mesas. Soils are moderately deep to very deep (20 to 60+ inches). Soil surface textures are loam, cobbly loam, gravelly loam, very cobbly sandy loam, very gravelly sandy loam, very stony sandy loam, very cobbly fine sandy loam, or stony fine sandy loam. Subsurface textures can be loamy-skeletal, or clayey-skeletal. It is usually ustic udic or typic udic and cryic. It is a Engelmann Spruce – Subalpine Fir – Elk Sedge – Slender Wheatgrass community. The effective precipitation ranges from 20 to 40 inches.</p>
F048AY908CO	<p><b>Mixed Conifer</b></p> <p>This site is found mostly commonly on mountain slopes. Soils are moderately deep to very deep (20 to 60+ inches). Soil surface textures are loam, very gravelly sandy loam, very stony sandy loam, stony sandy loam, stony loam, very stony loam, very cobbly loam or gravelly fine sandy loam. Subsurface textures can be loamy-skeletal or sometimes fine-loamy. It is usually ustic udic or typic udic and cryic. It is a Mixed Conifer community with subalpine fir, white fir, and Douglas fir intermixed. The effective precipitation ranges from 20 to 40 inches.</p>
F048AY915CO	<p><b>Engelmann Spruce – Whortleberry– Jacob's-Ladder</b></p> <p><i>Picea engelmannii/Vaccinium myrtillus/Polemonium pulcherrimum</i> This site is found mostly commonly on mountain slopes. Soils are very deep (&gt; 60+ inches). Soil surface textures are cobbly ashy loam, or cobbly ashy silt loam. Subsurface textures can be loamy-skeletal. It is usually ustic udic or typic udic and cryic. It is an Engelmann Spruce – whortleberry– Jacob's-ladder community. The effective precipitation ranges from 20 to 40 inches.</p>
F048AY449CO	<p><b>Aspen Woodland</b></p> <p>Aspen Woodland is a permanent type aspen stand in Western Colorado. This site is found mostly commonly on mountain slopes, hills, and complex landslides. Soils are moderately deep to very deep (20 to 60+ inches), dark and high in organic matter. Soil surface textures are loam, stony loam, very stony loam, cobbly loam, gravelly loam or very cobbly loam. Subsurface textures can be fine-loamy, loamy-skeletal, clayey-skeletal or fine. It is usually ustic udic and can be frigid or cryic. It is a Aspen – Wood's Rose – Slender Wheatgrass community. It Precipitation ranges from 20 to 30 inches, but on favorable north and east aspect it can be found as low as 18</p>

Table 1. Dominant plant species

Tree	(1) <i>Pinus contorta</i>
Shrub	(1) <i>Juniperus communis</i> (2) <i>Arctostaphylos uva-ursi</i>
Herbaceous	(1) <i>Carex geyeri</i>

## Physiographic features

This site is found on mountain slopes.

**Table 2. Representative physiographic features**

Landforms	(1) Mountain slope
Runoff class	High to very high
Flooding frequency	None
Ponding frequency	None
Elevation	2,591–3,048 m
Slope	10–75%

## Climatic features

Average annual precipitation is about 20 to 30 inches. Of this, approximately 65-75% falls as snow, and 25-35% falls as rain between middle of June to and the middle of September 1. Summer moisture is mostly from thundershowers in July, August and September. May to June is the driest period of the year with the driest month being June. December thru March is the wettest period and the wettest month is usually January. The average annual total snowfall is 198.5 inches. The snow depth usually ranges from 4 to 35 inches during November thru April. The highest winter snowfall record in this area is 354.5 inches which occurred in 1964-1965. The lowest snowfall record is 68.5 inches during the 1914-1915 winter. The frost-free period typically ranges from 25 to 90 days. The last spring frost is typically the end of June to the middle of July. The first fall frost is the first week of August to the first week of September. Mean daily annual air temperature is about 17.9°F to 51.5°F, averaging about 13.6°F for the winter and 54.9°F in the summer. Summer high temperatures of 70°F to mid-70°F are not unusual. The coldest winter temperature recorded was -47°F on February 6, 1982 and the warmest winter temperature recorded was 13.6°F on December 18, 1917. The coldest summer temperature recorded was 15°F on June 20, 1920 and the warmest was 95 °F on July 17, 1949. Wide yearly and seasonal fluctuations are common for this climatic zone. Data taken from Western Regional Climate Center (2018) for Crested Butte, Colorado Climate Station.

This zone in MLRA 48 will need to be broken up into at least 7 land resources zones in future projects based on current knowledge of precipitation and temperature patterns.

West Central Zone Stations: use in write up above. Driest month is June and wettest months are December thru March.

Northwest Zone Climate Stations: Marvine Ranch, Pyramid, Vail and Winter Park. Driest month is June and the wettest period is October thru April.

Southwest Zone Climate Stations (Precambrian sedimentary and igneous): Cascade, Electra Lake, Rico, Silverton, Telluride 4 WNW and Trout Lake. This area has driest month as June and the wettest months are July and August.

Southwest Volcanics: Platoro and Rio Grande Reservoir. The driest month is June and the Wettest are August and March.

Northeast (Front Range Igneous and Metamorphic): Allen's Park 2 NNW, Allen's Park NNW, Breckenridge, Climax, Jones Pass 2E, and Squaw Mountain. April, May, July and August are the wettest months. February, December, November and October are the driest.

Southeast (Sangre de Cristo Mtns): North Lake – This is the only climate station in this zone. It driest months are December and January with July being the wettest. So, this area receives more summer precipitation than other zones in this climate zone.

Frigid high elevation valleys: Aspen 1 SW, Ouray, Tacoma, Gross Reservoir, Coal Creek Canyon, Steamboat Springs, Marvine, and Buckskin Mtn 1 E. These areas have longer growing seasons by 20 to 40 days over the cryic stations.

**Table 3. Representative climatic features**

Frost-free period (characteristic range)	5-36 days
Freeze-free period (characteristic range)	40-76 days
Precipitation total (characteristic range)	508-762 mm
Frost-free period (actual range)	3-46 days
Freeze-free period (actual range)	32-88 days
Precipitation total (actual range)	508-762 mm
Frost-free period (average)	19 days
Freeze-free period (average)	56 days
Precipitation total (average)	635 mm

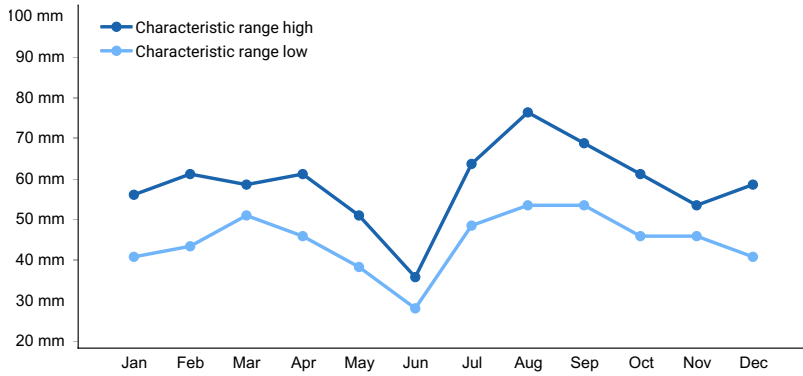

Figure 1. Monthly precipitation range

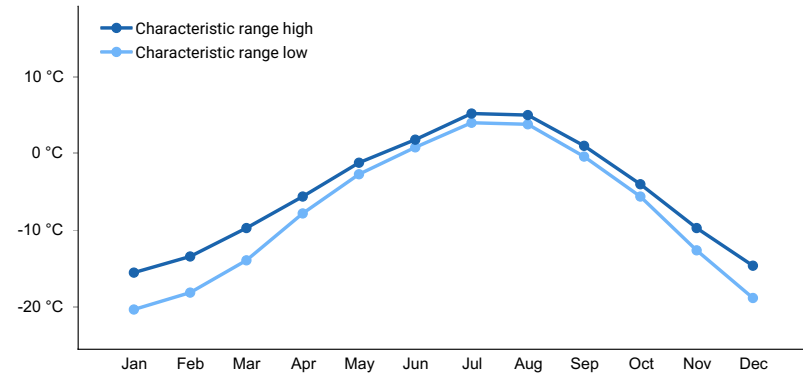

Figure 2. Monthly minimum temperature range

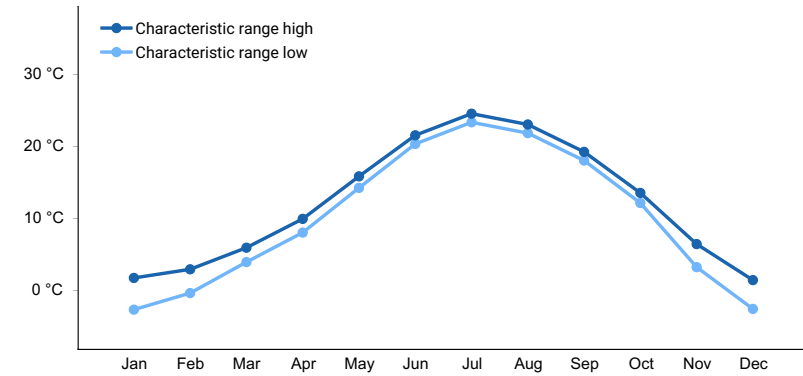
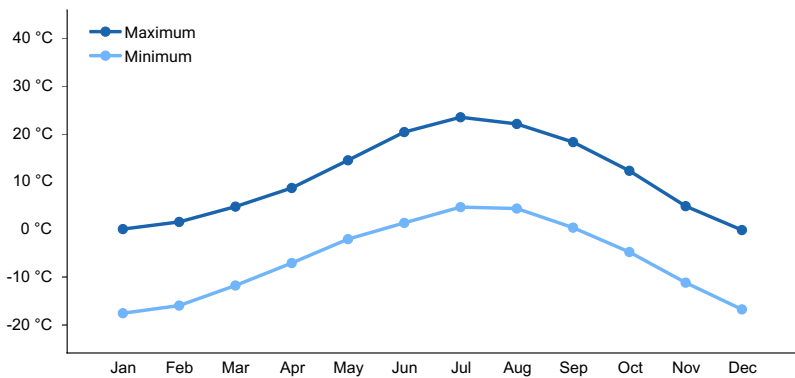
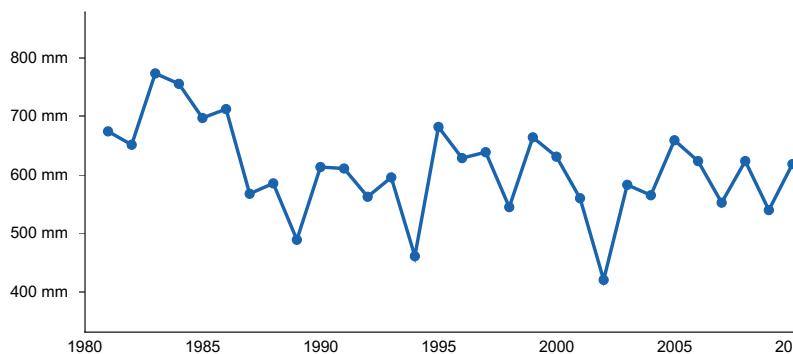

Figure 3. Monthly maximum temperature range



**Figure 4. Monthly average minimum and maximum temperature**



**Figure 5. Annual precipitation pattern**

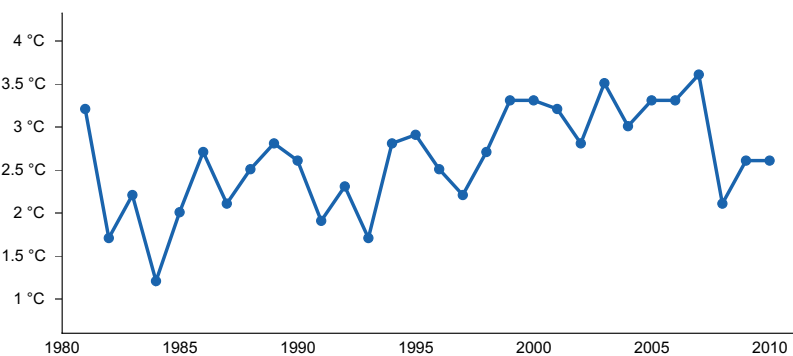

**Figure 6. Annual average temperature pattern**

### Climate stations used

- (1) CLIMAX [USC00051660], Leadville, CO
- (2) CRESTED BUTTE [USC00051959], Crested Butte, CO
- (3) MARVINE RCH [USC00055414], Meeker, CO
- (4) RICO [USC00057017], Cahone, CO
- (5) RIO GRANDE RSVR [USC00057050], Lake City, CO
- (6) SILVERTON [USC00057656], Silverton, CO
- (7) TELLURIDE 4WNW [USC00058204], Telluride, CO
- (8) VAIL [USC00058575], Vail, CO

### Influencing water features

None

### Soil features

Two different suitability groups have been identified based on soil properties. They are type 1: soils of brown podzolic & gray wooded groups. Under 2-4 inch layer pf humus of neutral to acid reaction, there is a thin A horizon,

or it may be lacking. There is a pale or obscure colored layer with little or no evidence of clay, followed by pronounced zone containing clay or clay skins on rock above parent materials. Soils are moderately deep to deep. Type 2 is shallow soils as described above in areas of lower precipitation.

**Table 4. Representative soil features**

Parent material	(1) Colluvium–sandstone and shale (2) Slope alluvium–sandstone and shale (3) Residuum–sandstone
Surface texture	(1) Very gravelly loam (2) Fine sandy loam (3) Cobbly fine sandy loam
Family particle size	(1) Loamy-skeletal (2) Clayey-skeletal
Drainage class	Well drained
Permeability class	Moderate to moderately rapid
Soil depth	20–203 cm
Surface fragment cover <=3"	0%
Surface fragment cover >3"	0%
Available water capacity (Depth not specified)	3.81–7.62 cm
Subsurface fragment volume <=3" (Depth not specified)	10–30%
Subsurface fragment volume >3" (Depth not specified)	30–40%

## Ecological dynamics

Below is a State and Transition Model diagram that illustrates the common plant communities and “states” (aggregations of those plant communities) that can occur on the site. Differences between communities and states depend primarily upon observations of a range of disturbance histories in areas where this ESD is represented. These situations include grazing gradients to water sources, fence-line contrasts, patches with differing dates of fire, herbicide treatment, tillage, tree harvest, etc. Reference State 1 illustrates the common plant communities that probably existed just prior to European settlement.

The major successional pathways within states, (“community pathways”) are indicated by arrows between communities. “Transitions” are indicated by arrows between states. The drivers of these changes are indicated in codes decipherable by referring to the legend at the bottom of the page and by reading the detailed narratives that follow the diagram. The transition between Reference State 1 and State 2 is considered irreversible because of the naturalization of exotic species of both flora and fauna, possible extinction of native species, and climate change. There may have also been accelerated soil erosion.

The plant communities shown in this State and Transition Model may not represent every possibility but are probably the most prevalent and recurring plant communities. As more monitoring data are collected, some phases or states may be revised, removed, and/or new ones may be added. None of these plant communities should necessarily be thought of as “Desired Plant Communities.” According to the USDA NRCS National Range & Pasture Handbook (USDA-NRCS 2003), Desired Plant Communities (DPC’s) will be determined by the decision-makers and will meet minimum planning criteria established by the NRCS. The main purpose for including descriptions of a plant community is to capture the current knowledge at the time of this revision.

### State 1 Reference State

The Reference State is a description of this ecological site just prior to Euro-American settlement but long after the arrival of Native Americans. At the time of European colonization, what would have been observed on these sites depended on the time since the last wildfire occurred. If the site had not seen fire for about 100 to 120 years, lodgepole pine (*Pinus contorta*) would have been the dominant species occupying the site with a sparse understory

(1.1) due to tree competition, overstory shading, and duff accumulation. Wildfire (1.1a) would have replaced these stands with a rich herb-dominated vegetation. (1.2). In the absence of any major disturbance (1.2a, 1.3a, 1.4a), the vegetation would have progressed into more of a shrub-herb co-dominance (1.3), followed by the establishment of lodgepole pine (1.4), and ultimately to fully mature lodgepole pine forest (1.1). Wildfire (1.1a) would have been the primary disturbance factor prior to Euro-American settlement. Early successional stages were shorter in duration.

#### Community 1.1 Mature lodgepole pine/ sparse understory

This plant community would have been characterized by a stand of mature lodgepole pine with a sparse understory of Elk sedge, spike trisetum, strawberry and Oregon grape.

#### Community Pathway 1.1a:

Wildfire would have removed the trees, allowing shade-intolerant herbs to flourish briefly.

#### Community Phase 1.2: herb-dominated

An herb-dominated plant community would have developed within the first 5 years following the last fire. Elk sedge, spike trisetum, strawberry and Oregon grape and shade-intolerant forbs would have been the dominant grass species.

#### Community Pathway 1.2a:

After about 5 years, shrubs would begin to establish in the site.

#### Community Phase 1.3: shrub-herb co-dominance

Time since last fire would have been approximately 5 to 60 years. An increasing shrub component would have included Woods' Rose (*Rosa woodsii*), gooseberry currant (*Ribes* spp.), whortleberry (*Vaccinium* spp.), and Oregon boxleaf (*Paxistima myrsinites*), among others.

#### Community Pathway 1.3a:

About 60 years after fire, lodgepole pine would become established in the site.

#### Community Phase 1.4: immature lodgepole pine

This phase would have been characterized by a plant community of immature lodgepole pine along with a scattering of subalpine fir and/or Engelmann spruce (*Picea engelmannii*). This plant community would occur approximately 60 to 80 years after the last fire.

#### Community Pathway 1.4a:

About 100 years after fire, lodgepole pine would have become mature and the understory would have become sparse.

#### Transition T1a: from State 1 to State 2 (Reference State to Secondary Forest/ Introduced State)

Historic change, including the simultaneous introduction of exotic species, both plants and animals, possible extinctions of native flora and fauna, and climate change, has caused State 1 to transition to State 2. Europeans further altered this vegetation largely through tree harvest, livestock grazing, and changing the fire regime. Continued impacts could prevent the recovery toward potential conifer dominance (State 2, various phases). The reversal of these changes (i.e. a return pathway) back to State 1 is not practical.

#### State 2 Secondary Forest/ Introduced State

State 2 is similar to State 1 in form and function, with the exception of the presence of non-native plants and animals, possible extinctions of native species, a different climate, and a secondary stand of trees. State 2 is a description of the ecological site shortly following Euro-American settlement (Alexander 1985, 1988). This state can be regarded as the current potential. With the least amount of disturbance or manipulation of fire regime, a mature stand of lodgepole pine with a sparse understory component is expected at this site (2.1). As with the Reference State, time since last wildfire remains the key factor in determining what vegetation would be encountered here. Wildfire, particularly crown fires, or complete harvesting of the forest (2.1b, 2.5b) will replace these stands with a rich herb-dominated vegetation. (2.2). In the absence of any major disturbance (2.2a, 2.3a, 2.4a), the vegetation will progress into more of a shrub-herb co-dominance (2.3), followed by the establishment of lodgepole pine (1.4), and ultimately to fully mature lodgepole pine forest (1.1). In some areas where wildfire has been prevented, lodgepole pine trees may be over-mature (2.5) and consequently become more susceptible to infestation by insects and other pathogens (2.1a).



#### Community 2.1 Mature lodgepole pine/ sparse understory

This plant community is characterized by a stand of mature lodgepole pine with a sparse understory of Elk sedge, spike trisetum, strawberry and Oregon grape. and shade-tolerant forbs. This stand will develop approximately 100 to 120 years post fire.

##### Community Pathway 2.1a:

With fire exclusion, and well over 100 years since last fire, a lodgepole pine stand will ultimately deteriorate and will become increasingly susceptible to infestation of insects or other pathogens.

##### Community Pathway 2.1b:

A stand-replacing wildfire or intensive logging will return the vegetation to an early seral herb-dominated phase. Logging opens up the forest canopy allowing more understory for 20 to 30 years.

##### Community Pathway 2.1c:

The removal of only the mature lodgepole pine (a selective timer harvest) will allow the immature lodgepole pine to continue growing.

#### Community Phase 2.2: herb-dominated

This plant community will develop within the first 5 years since the last fire. Dominant grasses are Elk sedge, spike trisetum, strawberry and Oregon grape, along with shade-intolerant forbs. A small component of introduced species may be present.

##### Community Pathway 2.2a:

This pathway is characterized by natural succession. The combination of heavy season-long livestock grazing and fire exclusion will accelerate woody plant recovery and diminish the understory.

#### Community Phase 2.3: shrub-herb co-dominance

A plant community co-dominated by shrubs and herbs will develop approximately 5 to 60 years post-fire. A small component of introduced species may be present.

##### Community Pathway 2.3a:

This pathway is characterized by natural succession. The combination of heavy season-long livestock grazing and fire exclusion will accelerate woody plant recovery and diminish the understory.

#### Community Phase 2.4: immature lodgepole pine/ scattered Engelmann spruce

This plant community will develop approximately 60 to 80 years since the last fire.

##### Community Pathway 2.4a:

This pathway is characterized by natural succession. The combination of heavy season-long livestock grazing and fire exclusion will accelerate woody plant recovery and diminish the understory.

#### Community Phase 2.5: over-mature blighted lodgepole pine/ understory absent

This plant community is the result of fire exclusion for well over 120 years. The lodgepole pine is over-mature and weakened, making it susceptible to infestation by insects or other pathogens.

##### Community Pathway 2.5a:

A stand-replacing wildfire or intensive logging will return the vegetation to an early seral herb-dominated phase. Logging opens up the forest canopy allowing more understory for 20 to 30 years.

#### Transition T2a: from State 2 to State 3 (Secondary Forest/ Introduced State to Tertiary Forest/ Degraded State)

The Secondary Forest/ Introduced State will transition to the Tertiary Forest/ Degraded State following a second cycle of timber harvest or stand replacing wildfire and further impacts from heavy continuous season-long grazing. Logging opens up the forest canopy allowing more understory for 20 to 30 years. Secondary and tertiary disturbances will produce an array of vegetation. Key indicators of the approach to this transition are a reduction in species diversity, gaps in the litter and duff layer, and evidence of accelerated soil erosion. Excessive human utilization triggers this transition. A restoration pathway is possible through moderation of human use, and proactive management.

### State 3 Tertiary Forest/ Degraded State

State 3 is characterized by tertiary forests that are degraded in both understory and tree condition. Fire suppression speeds up the dominance by woody plants.

#### Community Phase 3.1: mature lodgepole pine/ sparse understory

This plant community (3.1) is characterized by a stand of mature lodgepole pine. A sparse understory of Elk sedge, spike trisetum, strawberry and Oregon grape and shade tolerant forbs may be present. This stand will develop approximately 100 to 120 years post-fire.

#### Community Pathway 3.1a:

With well over 120 years since the last fire, lodgepole pine will ultimately deteriorate, increasing its susceptibility to infestation by insects or other pathogens.

#### Community Pathway 3.1b:

A stand-replacing wildfire or intensive logging will return the vegetation to an early seral herb-dominated phase. Logging opens up the forest canopy allowing more understory for 20 to 30 years.

#### Community Pathway 3.1c:

The removal of only the mature lodgepole pine (a selective timber harvest) will allow the immature lodgepole pine to continue growing.

#### Community Phase 3.2: herb-dominated

This plant community will develop within the first 5 years since the last fire. Dominant species include pinegrass, nodding bluegrass, Letterman's needlegrass, and shade intolerant forbs such as subalpine fleabane. A small component of introduced species may be present.

#### Community Pathway 3.2a:

This pathway is characterized by natural succession.

#### Community Phase 3.3: shrub-herb co-dominance

A plant community co-dominated by shrubs and herbs will develop approximately 5 to 60 years post-fire. A small component of introduced species may be present.

#### Community Pathway 3.3a:

This pathway is characterized by natural succession.

#### Community Phase 3.4: immature lodgepole pine/ scattered Engelmann Spruce

This plant community will develop approximately 60 to 80 years since the last fire, and is characterized by immature lodgepole pine with scattered Engelmann spruce.

#### Community Pathway 3.4a:

This pathway is characterized by natural succession.

#### Community Phase 3.5: over-mature blighted lodgepole pine/ understory absent

This plant community is the result of fire exclusion for well over 120 years. The lodgepole pine is over-mature and weakened, increasing its susceptibility to infestation by insects or other pathogens.

#### Community Pathway 3.5a:

A stand-replacing wildfire will return the vegetation to an early seral shade-intolerant herb-dominated phase.

### State and transition model



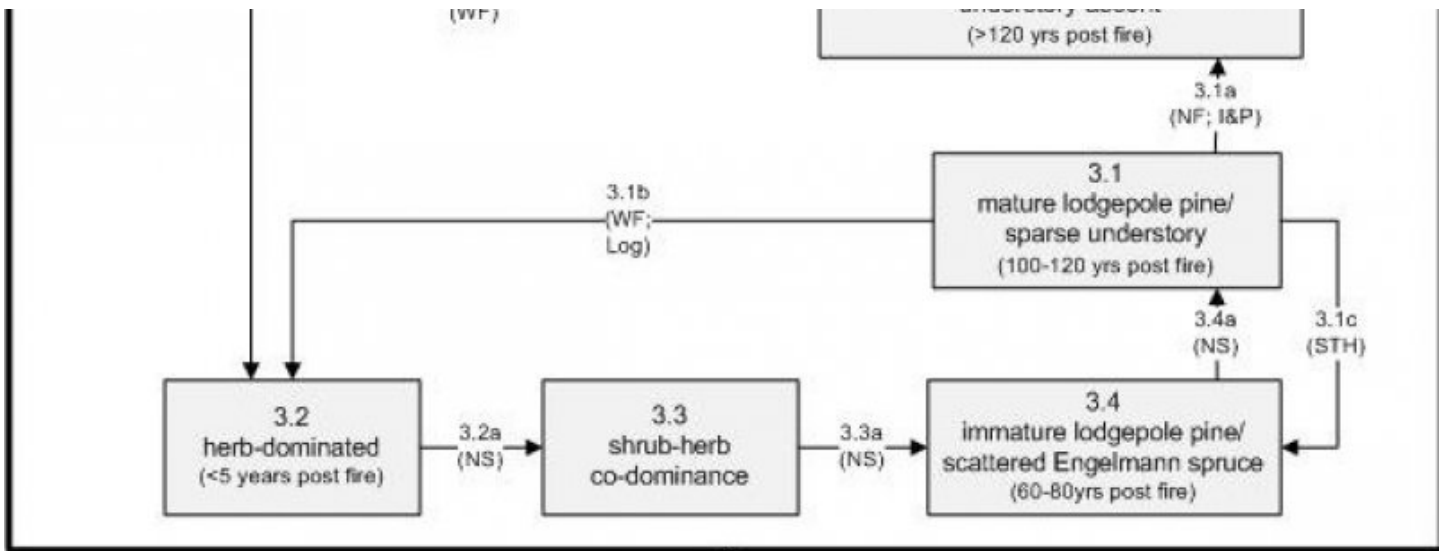

T2a  
(Log or WF; HCSLG)

## 2. Secondary Forest/ Introduced State

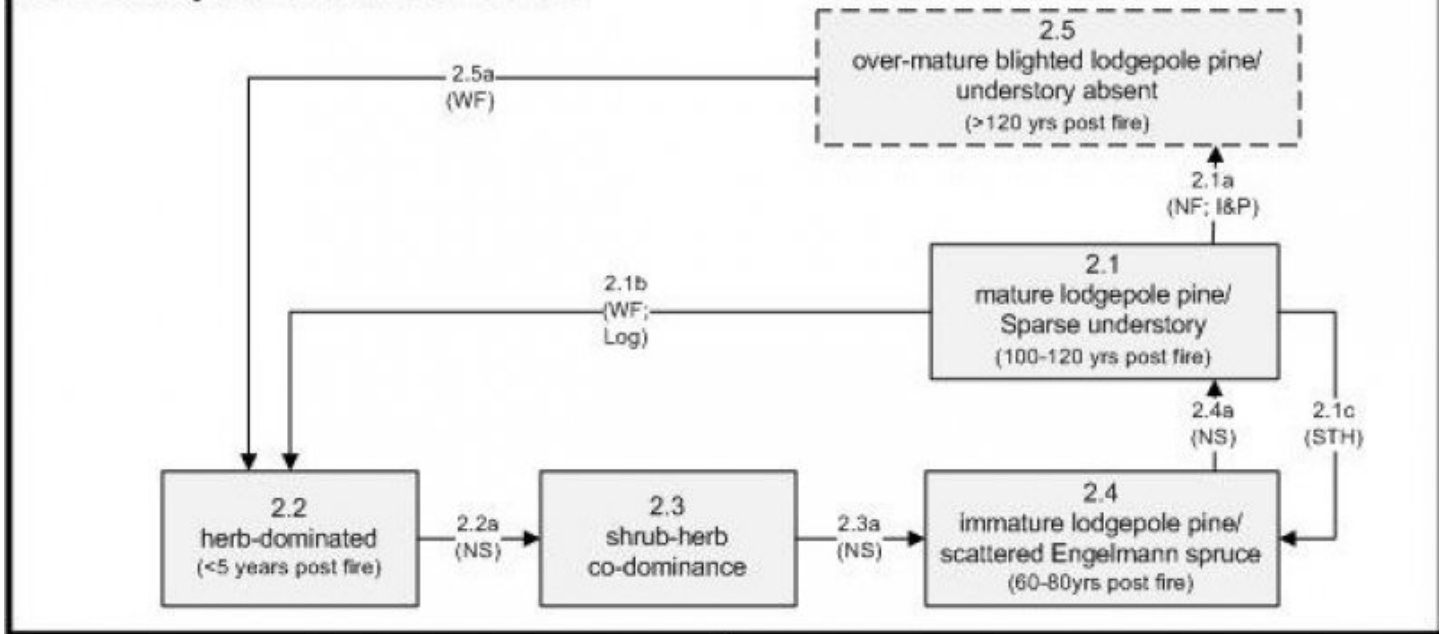

T1a  
(HC;  
Log or WF; HCSLG)

## 1. Reference State

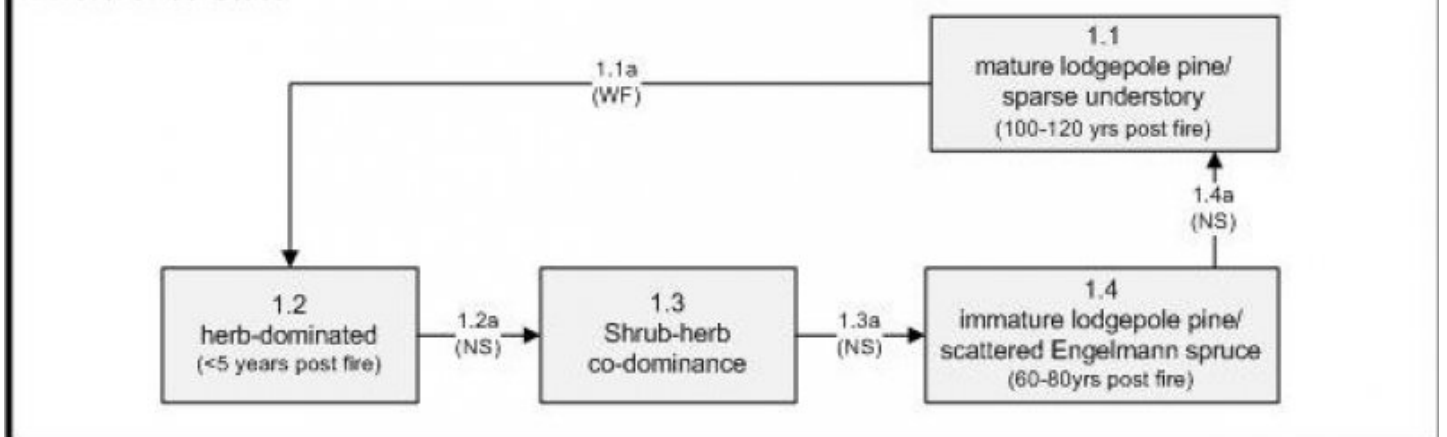

HC Historic Change  
HCSLG Heavy Continuous Season Long Grazing  
I&P Insects & Other Pathogens  
Log Logging

NF No Fire  
NS Natural Succession  
STH Selective Timber Harvest  
WF Wildfire

## State 1

### Reference State

Associated species: Stands are usually single age. May occur as pure stands following fire. Often appears stabilized over large areas. Where it is on a successional stage it will be mixed with Douglas fir in its lower elevations, and with Spruce and fir in the middle and higher elevations. Aspen may be associated with it throughout its range.

Associated understory plants: Spike trisetum, mountain brome, shrubby cinquefoil, oregon grape, elk sedge, boxleaf myrtle, strawberry, and common juniper. Effects of aspect and position: aspect and position do not seem to affect lodgepole pine to the extent other species are affected. Annual air-dry total production in unfavorable years averages 200 lbs/acre; average years 300 lbs/acre and in favorable years 400 lbs./acre.

### Animal community

Grazing Use: In dense stands there is no grazing. Older stands have very little grazing except in parks and openings in this site. Season of use is the same as for subalpine loam ecological site.

### Wood products

Site index: low to high. It is often difficult to get a proper site index rating in this type of site since many stands become stagnated due to overstocked regeneration. Normal site index runs from 40 to 100, with lower sites on shallow gray wooded soils with little or no A horizon. Site index seems to increase as the A horizon deepens, up to a maximum of about 6 inches.

Light tolerance: Lodgepole pine is very intolerant to shade.

Uses for species: limber, posts, poles, ties and pulp.

Spacing requirements: Use  $D+4)^2$  spacing for stands where site index is above 60 in stands 4" to 8" dbh., and where mistletoe is not present.

Ability to reproduce naturally: Requires large openings, exposed to sunlight and mineral soil. Heavy reproduction may occur following burning the site. The cones often do not open unless subjected to some heat. There is seldom reproduction in young stands, and very slight if any reproduction in older stands.

### Other products

Dwarf mistletoe infects a large percent of the older stands in the state and results in a reduction in growth of 30-35% in saw timber size trees. Any partial cutting favors the development of this disease where it is present.

### Other references

Chapman, S.S., G.E. Griffith, J.M. Omernik, A.B. Price, J. Freeouf, and D.L. Schrupp. 2006. Ecoregions of Colorado. (2-sided color poster with map, descriptive text, summary tables, and photographs). U.S. Geological Survey, Reston, VA. Scale 1:1,200,000.

Cleland, D.T.; Freeouf, J.A.; Keys, J.E.; Nowacki, G.J.; Carpenter, C.A.; and McNab, W.H. 2007. Ecological Subregions: Sections and Subsections for the conterminous United States. Gen. Tech. Report WO-76D [Map on CD-ROM] (A.M. Sloan, cartographer). Washington, DC: U.S. Department of Agriculture, Forest Service, presentation scale 1:3,500,000; colored.

Soil Conservation Service (SCS). January 1966. Forested Site Description for Lodgepole Pine. : USDA, Denver Colorado.

United States Department of Agriculture, Natural Resources Conservation Service. 2006. Land Resource Regions and Major Land Resource Areas of the United States, the Caribbean, and the Pacific Basin. U.S. Department of Agriculture Handbook 296.

Western Regional Climate Center. Retrieved from <http://www.wrcc.dri.edu/summary/Climsmco.html> on December 10, 2018

## Contributors

Suzanne Mayne-Kinney

## Approval

Kirt Walstad, 3/05/2024

## Acknowledgments

### Project Staff:

Suzanne Mayne-Kinney, Ecological Site Specialist, NRCS MLRA, Grand Junction SSO  
Chuck Peacock, MLRA Soil Survey Leader, NRCS MLRA Grand Junction SSO

### Program Support:

Rachel Murph, NRCS CO State Rangeland Management Specialist, Denver  
Scott Woodhall, NRCS MLRA Ecological Site Specialist-QA Phoenix, AZ  
Eva Muller, Regional Director, Rocky Mountain Regional Soil Survey Office, Bozeman, MT  
B.J. Shoup, CO State Soil Scientist, Denver  
Eugene Backhaus, CO State Resource Conservationist, Denver

Those involved in developing earlier versions of this site description include: Bob Rayer, retired NRCS Soil Scientist; Herman Garcia, retired CO State RMS and NRCS MLRA Ecological Site Specialist-QA Phoenix, AZ.

### --Site Development and Testing Plan--:

Future work to validate and further refine the information in this Provisional Ecological Site Description is necessary. This will include field activities to collect low-, medium-, and high-intensity sampling, soil correlations, and analysis of that data.

Additional information and data is required to refine the Plant Production and Annual Production tables for this ecological site. The extent of MLRA 48A must be further investigated.

Field testing of the information contained in this Provisional ESD is required. As this ESD is moved to the Approved ESD level, reviews from the technical team, quality control, quality assurance, and peers will be conducted.

## Rangeland health reference sheet

Interpreting Indicators of Rangeland Health is a qualitative assessment protocol used to determine ecosystem condition based on benchmark characteristics described in the Reference Sheet. A suite of 17 (or more) indicators are typically considered in an assessment. The ecological site(s) representative of an assessment location must be known prior to applying the protocol and must be verified based on soils and climate. Current plant community cannot be used to identify the ecological site.

Author(s)/participant(s)	
Contact for lead author	
Date	05/17/2024
Approved by	Kirt Walstad
Approval date	
Composition (Indicators 10 and 12) based on	Annual Production

## Indicators

1. **Number and extent of rills:**  

---
2. **Presence of water flow patterns:**  

---
3. **Number and height of erosional pedestals or terracettes:**  

---
4. **Bare ground from Ecological Site Description or other studies (rock, litter, lichen, moss, plant canopy are not bare ground):**  

---
5. **Number of gullies and erosion associated with gullies:**  

---
6. **Extent of wind scoured, blowouts and/or depositional areas:**  

---
7. **Amount of litter movement (describe size and distance expected to travel):**  

---
8. **Soil surface (top few mm) resistance to erosion (stability values are averages - most sites will show a range of values):**  

---
9. **Soil surface structure and SOM content (include type of structure and A-horizon color and thickness):**  

---
10. **Effect of community phase composition (relative proportion of different functional groups) and spatial distribution on infiltration and runoff:**  

---
11. **Presence and thickness of compaction layer (usually none; describe soil profile features which may be mistaken for compaction on this site):**  

---
12. **Functional/Structural Groups (list in order of descending dominance by above-ground annual-production or live foliar cover using symbols: >>, >, = to indicate much greater than, greater than, and equal to):**

Dominant:

Sub-dominant:

Other:

Additional:

---

13. **Amount of plant mortality and decadence (include which functional groups are expected to show mortality or decadence):**
- 

14. **Average percent litter cover (%) and depth ( in):**
- 

15. **Expected annual annual-production (this is TOTAL above-ground annual-production, not just forage annual-production):**
- 

16. **Potential invasive (including noxious) species (native and non-native). List species which BOTH characterize degraded states and have the potential to become a dominant or co-dominant species on the ecological site if their future establishment and growth is not actively controlled by management interventions. Species that become dominant for only one to several years (e.g., short-term response to drought or wildfire) are not invasive plants. Note that unlike other indicators, we are describing what is NOT expected in the reference state for the ecological site:**
- 

17. **Perennial plant reproductive capability:**
-