

Ecological site R048AY122WY Mountain Loam

Last updated: 3/05/2024
Accessed: 12/04/2024

General information

Provisional. A provisional ecological site description has undergone quality control and quality assurance review. It contains a working state and transition model and enough information to identify the ecological site.

MLRA notes

Major Land Resource Area (MLRA): 048A–Southern Rocky Mountains

MLRA 48A makes up about 45,920 square miles (119,000 square kilometers) and is the southern part of the Rocky Mountains. The Southern Rocky Mountains lies east of the Colorado Plateau, south of the Wyoming Basin, west of the Great Plains, and north of the Rio Grande Rift. It is in western and central Colorado, southeastern Wyoming, eastern Utah, and northern New Mexico. The headwaters of major rivers such as the Colorado, Yampa, Arkansas, Rio Grande, North Platte and South Plate rivers are located here. This MLRA has numerous national forests, including the Medicine Bow National Forest in Wyoming; the Routt, Arapaho, Roosevelt, Pike, San Isabel, White River, Gunnison, Grand Mesa, Uncompahgre, Rio Grande, and San Juan National Forests in Colorado; the Carson National Forest and part of the Santa Fe National Forest in New Mexico. Rocky Mountain National Park also is in this MLRA.

MLRA 48A is the southern Rocky Mountains physiographic region. The Southern Rocky Mountains consist primarily of two belts of strongly sloping to precipitous mountain ranges trending north to south. Several basins, or parks, are between the belts. Some high mesas and plateaus are included. It is characterized by mountain ranges that were uplifted during the Laramide Orogeny and then had periods of glaciation. The ranges include the Sangre de Cristo Mountains, the Laramie Mountains, and the Front Range in the east and the San Juan Mountains and the Sawatch and Park Ranges in the west. The ranges are dissected by many narrow stream valleys having steep gradients. In some areas the upper mountain slopes and broad crests are covered by snowfields and glaciers. Elevation typically ranges from 6,500 to 14,400 feet (1,980 to 4,390 meters) in this area. The part of this MLRA in central Colorado includes the highest point in the Rockies, Mount Elbert, which reaches an elevation of 14,433 feet (4,400 meters). More than 50 peaks in the part of the MLRA in Colorado are at an elevation of more than 14,000 feet (4,270 meters). Many small glacial lakes are in the high mountains.

The mountains in this area were formed mainly by crustal uplifts during the late Cretaceous and early Tertiary periods. This large MLRA can be subdivided into at least 4 large general divisions. First is the Rockies on the east side of this area are called the "Front Range," which is a fault block that has been tilted up on edge and uplifted and is largely igneous and metamorphic geology. It was tilted up on the east edge, so there is a steep front on the east and the west side is more gently sloping and in the south east there are rocks exposed in the mountains are mostly Precambrian igneous and metamorphic rocks. Second is the tertiary rocks, primarily basalt and andesitic lava flows, tuffs, breccias, and conglomerates, are throughout this area (San Juan Mountains Area). The third division is Northwest part of the MLRA is dominantly sedimentary rock from the cretaceous/tertiary and Permian/Pennsylvanian periods. The fourth subset is the long and narrow Sangre de Cristos mountains uplifted in the Cenozoic are between the Rio Grande rift and the great plains. Many of the highest mountain ranges were reshaped by glaciation during the Pleistocene. Alluvial fans at the base of the mountains are recharge zones for local basin and valley fill aquifers. They also are important sources of sand and gravel.

The average annual precipitation ranges predominantly from 12 to 63 inches. Summer rainfall commonly occurs as high-intensity, convective thunderstorms. About half of the annual precipitation occurs as snow in winter; this proportion increases with elevation. In the mountains, deep snowpacks accumulate throughout the winter and

generally persist into spring or early summer, depending on elevation. Some permanent snowfields and small glaciers are on the highest mountain peaks. In the valleys at the lower elevations, snowfall is lighter and snowpacks can be intermittent. The average annual temperature is 26 to 54 degrees F (-3 to 12 degrees C). The freeze-free period averages 135 days and ranges from 45 to 230 days, decreasing in length with elevation. The climate of this area is strongly dependent upon elevation; precipitation is greater, and temperatures are cooler at the higher elevations. The plant communities vary with elevation, aspect and change in latitudes due to changing in precipitation kind and timing and temperature.

The dominant soil orders in this MLRA are Mollisols, Alfisols, Inceptisols, and Entisols. The soils in the area dominantly have a frigid or cryic soil temperature regime and an ustic or udic soil moisture regime. Mineralogy is typically mixed, smectitic, or paramicaceous. In areas with granite, gneiss, and schist bedrock, Glossocryalfs (Seitz, Granile, and Leadville series) and Haplocryolls (Rogert series) formed in colluvium on mountain slopes. Dystrocryepts (Leighcan and Mummy series) formed on mountain slopes and summits at the higher elevations. In areas of andesite and rhyolite bedrock, Dystrocryepts (Endlich and Whitecross series) formed in colluvium on mountain slopes. In areas of sedimentary bedrock, Haplustolls (Towave series) formed on mountain slopes at low elevations and with low precipitation. Haplocryolls (Lamphier and Razorba series), Argicryolls (Cochetopa series), and Haplocryalfs (Needleton series) formed in colluvium on mountain slopes at high elevations.

LRU notes

Moisture Regime: typic ustic

Temperature Regime: Cryic

Dominant Cover: rangeland

Representative Value (RV) Effective Precipitation: 16-20 inches

RV Frost-Free Days: 30-60 days

Classification relationships

Site Name: Mountain Loam

Site Type: Rangeland

Site ID: R048AY122WY

Precipitation or Climate Zone: 15-19" P.Z.

National Vegetation Classification System (NVC):

Class

3 Xeromorphic Woodland, Scrub & Herb Vegetation Class

Subclass

3.B Cool Semi-Desert Scrub & Grassland Subclass

Formation

3.B.1 Cool Semi-Desert Scrub & Grassland Formation

Division

3.B.1.Ne Western North American Cool Semi-Desert Scrub & Grassland Division

Macrogroup

3.B.1.Ne Great Basin & Intermountain Tall Sagebrush Shrubland & Steppe Macrogroup

Group

3.B.1.Ne Artemisia tridentata ssp. spiciformis - Artemisia tridentata ssp. vaseyana - Artemisia cana ssp. viscidula

Tall Shrubland & Steppe Group

Association

3.B.1.Ne Artemisia tridentata ssp. vaseyana / Leucopoa kingii Shrubland

Ecoregions (EPA):

Level I: 10 North American Deserts Level II: 10.1 Cold Deserts

Level III: 10.1.4 Wyoming Basin

Ecological site concept

Site does not receive any additional water.

Soils are: not saline or saline-sodic.

moderately deep to deep, with < 3% stone (10-25") and boulder (>25") cover. not skeletal within 20" of soil surface.
 not strongly or violently effervescent in surface mineral 10".
 textures usually range from loam to clay loam in surface mineral 4". Slope is < 15%.
 Clay content average is = 32% in surface mineral 4".
 Site does not have an argillic horizon with > 35% clay

Associated sites

R049XA122WY	Loamy (Foothills and Mountains Southeast)
-------------	--

Similar sites

R043BY322WY	Loamy (Ly) 15-19" Foothills and Mountains East Precipitation Zone
R048AY228CO	Mountain Loam
R048AY405UT	Mountain Loam (Mountain Big Sagebrush)

Table 1. Dominant plant species

Tree	Not specified
Shrub	(1) <i>Artemisia tridentata</i> var. <i>vaseyana</i>
Herbaceous	(1) <i>Achnatherum nelsonii</i> (2) <i>Nassella viridula</i>

Physiographic features

This ecological site occurs in intermontane basin landscapes on hill, draw, pediment, and fan remnant landforms (see definitions below). The slope ranges from level to 15 percent. This site occurs on all aspects.

intermontane basin – A generic term for wide structural depressions between mountain ranges that are partly filled with alluvium and called "valleys" in the vernacular.

hills – A landscape dominated by hills and associated valleys. The landform term is singular (hill).

fan remnant – A general term for landforms that are the remaining parts of older fan-landforms, such as alluvial fans, fan aprons, inset fans, and fan skirts, that either have been dissected (erosional fan-remnants) or partially buried (nonburied fan-remnants). An erosional fan remnant must have a relatively flat summit that is a relict fan-surface.

Table 2. Representative physiographic features

Landforms	(1) Hill (2) Fan remnant
Flooding frequency	None
Ponding frequency	None
Elevation	2,164–2,621 m
Slope	0–15%
Aspect	Aspect is not a significant factor

Climatic features

Annual precipitation ranges from 16-20 inches per year. May is generally the wettest month with an average of nearly two inches of precipitation, although precipitation averages over an inch each month in July, August, and September. Annual snowfall averages about 78 inches. Because of the varied topography, the wind will vary considerably for different parts of the area. The wind is usually much lighter at the lower elevations and in the valleys as compared with the higher terrain. The average winter wind velocity is 8.5 mph while the summer wind

velocity averages 7.5 mph. Winds during storms and on ridges may exceed 45 mph. Growth of native cool-season plants begins about May 1 to May 15 and continues to about October 10.

Table 3. Representative climatic features

Frost-free period (characteristic range)	30-60 days
Freeze-free period (characteristic range)	
Precipitation total (characteristic range)	406-508 mm
Frost-free period (actual range)	30-60 days
Freeze-free period (actual range)	
Precipitation total (actual range)	406-508 mm
Frost-free period (average)	45 days
Freeze-free period (average)	86 days
Precipitation total (average)	457 mm

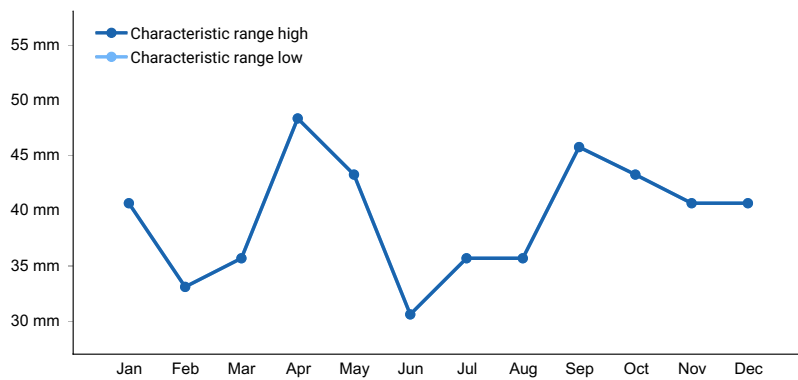

Figure 1. Monthly precipitation range

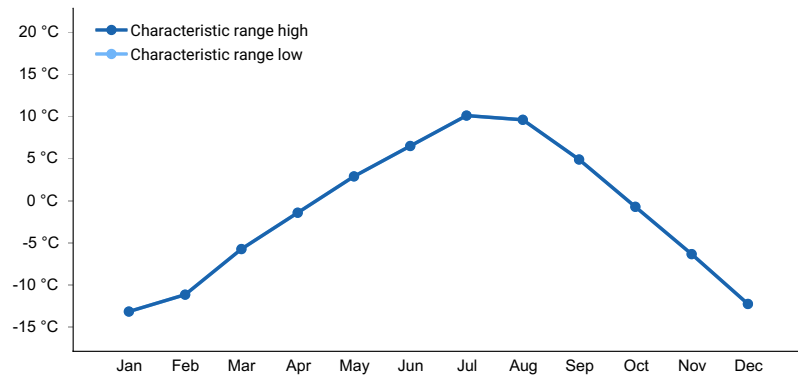

Figure 2. Monthly minimum temperature range

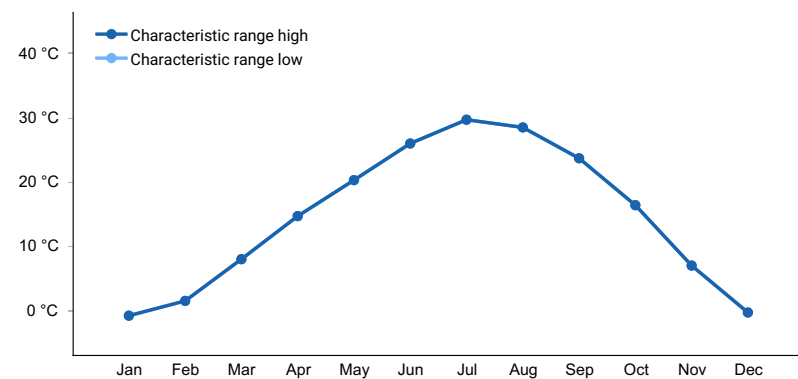

Figure 3. Monthly maximum temperature range

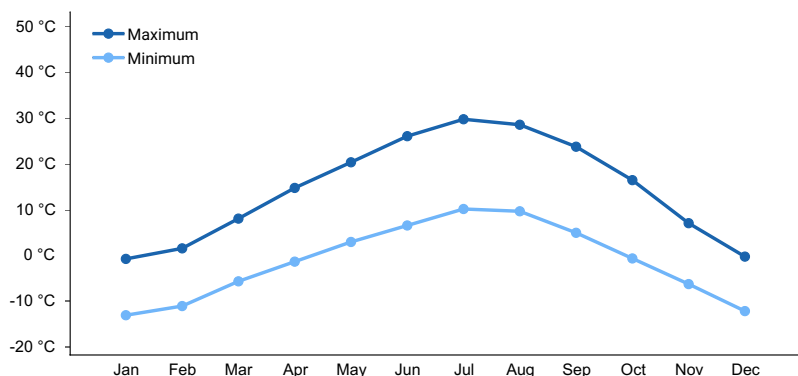

Figure 4. Monthly average minimum and maximum temperature

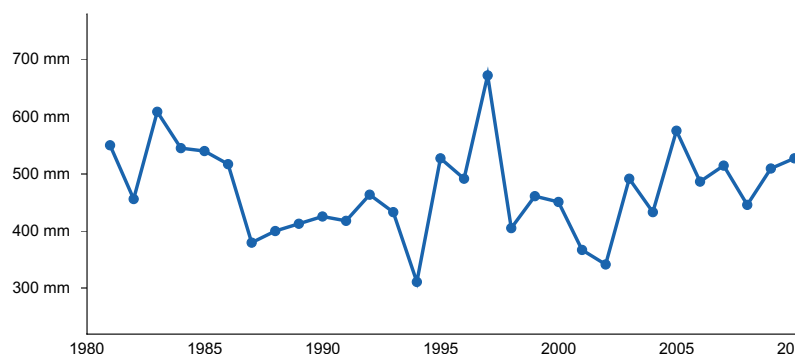

Figure 5. Annual precipitation pattern

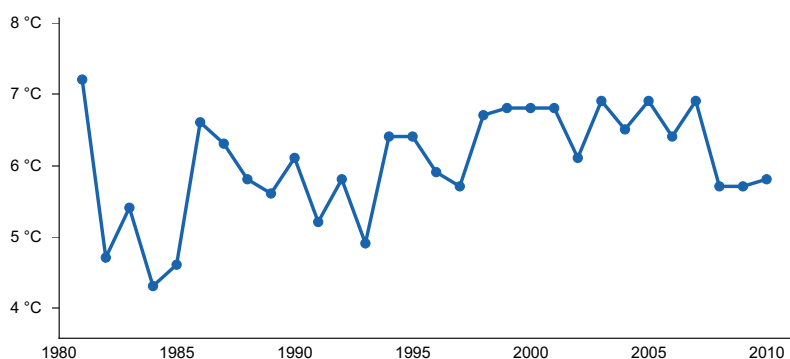

Figure 6. Annual average temperature pattern

Climate stations used

- (1) HAYDEN [USC00053867], Hayden, CO

Influencing water features

None

Soil features

The soils of this site are deep to moderately deep (greater than 20" to bedrock), moderately well to well-drained & moderately slow to moderately permeable. The surface soil will vary from 3" to 6" in thickness depending on the texture and permeability of the subsoil. The soil characteristic having the most influence on the plant community is the available moisture and depth to a root restrictive barrier.

Table 4. Representative soil features

Parent material	(1) Alluvium–sandstone and shale (2) Residuum–quartzite
-----------------	--

Surface texture	(1) Loam (2) Clay loam (3) Sandy clay loam (4) Gravelly loam
Family particle size	(1) Fine-loamy
Drainage class	Moderately well drained to well drained
Permeability class	Moderately slow to moderate
Soil depth	51–152 cm
Surface fragment cover <=3"	0–10%
Surface fragment cover >3"	0–10%
Available water capacity (Depth not specified)	7.62–16 cm
Calcium carbonate equivalent (Depth not specified)	0–10%
Electrical conductivity (Depth not specified)	0–4 mmhos/cm
Sodium adsorption ratio (Depth not specified)	0–5
Soil reaction (1:1 water) (Depth not specified)	6.6–8.4
Subsurface fragment volume <=3" (Depth not specified)	0–15%
Subsurface fragment volume >3" (Depth not specified)	0–10%

Ecological dynamics

Potential vegetation on this site is dominated by mid-statured cool-season perennial grasses. Other significant vegetation includes Mountain big sagebrush, and a variety of forbs.

The expected potential composition for this site is about 70% grasses, 15% forbs and 15% woody plants. The composition and production will vary naturally due to historical use, fluctuating precipitation and fire frequency.

As this site deteriorates species such as mountain big sagebrush, rabbitbrush spp., Idaho fescue, western wheatgrass, and bluegrasses will increase. Mid-statured cool season grasses such as spike fescue and needlegrasses will decrease in frequency and production. If conditions deteriorate further, Idaho fescue will decrease and annual forbs such as alyssum will increase.

Mountain big sagebrush may become dominant on areas with an absence of fire. Wildfires have been actively controlled in recent times and as a result mature stands of Mountain big sagebrush with canopy cover that may reach fifty percent or more may persist. Chemical and mechanical controls have replaced the historic role of fire on this site. Recently, prescribed burning has regained some popularity.

Mountain big sagebrush component will likely re-establish to some degree after fire depending on fire severity and surviving plants. Recruitment after a severe fire comes from a short-lived seed bank, or seed from nearby plants (Johnson and Payne 1968, Bushey 1987). If sufficient moisture is available, mountain big sagebrush may reach five percent canopy cover within 5 years (Pederson et al. 2003, Miller, unpublished data). It typically takes 25 years to reach a canopy cover of twenty-five percent, but may occur as early as nine years, or take forty years or more to reach a late seral state with twenty-five percent canopy cover of mountain big sagebrush (Winward 1991, Pedersen et. al. 2003, Miller, unpublished data). Sprouting species such as mountain snowberry and antelope bitterbrush may re-establish to pre-burn levels in two to three years depending on climatic conditions. The exception to this is where the herbaceous component is severely degraded at the time of wildfire or brush management treatment; growing conditions are unfavorable after treatment, and/or recovery of herbaceous species are inadequate due to drought,

poor grazing management or excessive wildlife use. Regeneration of Mountain big sagebrush may also be suppressed if rabbitbrush species or snowberry are established prior to disturbance as they are more likely to re-sprout and occupy space. Any thinning project should be designed in a way to maintain the viability of the stand and to consider wildlife requirements.

Conifer encroachment can occur on this site without wildfire. Rocky Mountain juniper is the most common species.

The Reference Plant Community (description follows the plant community diagram) has been determined by study of rangeland relic areas, or areas protected from excessive disturbance. Trends in plant communities going from heavily grazed areas to lightly grazed areas, seasonal use pastures, and historical accounts have also been used.

The following is a State and Transition Model Diagram that illustrates the common plant communities (states) that can occur on the site and the transitions between these communities. The ecological processes will be discussed in more detail in the plant community narratives following the diagram.

State and transition model

Ecosystem states

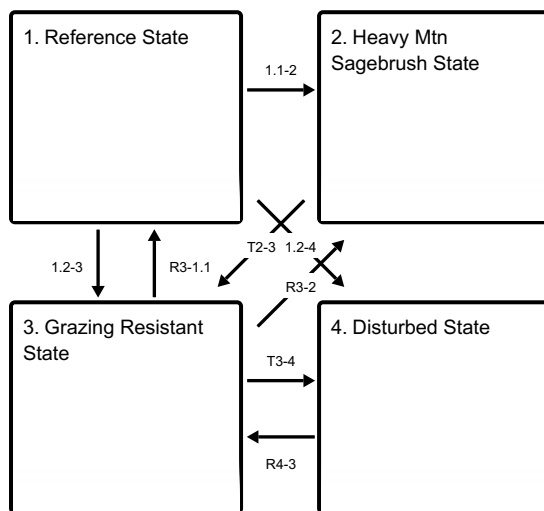

State 1 submodel, plant communities

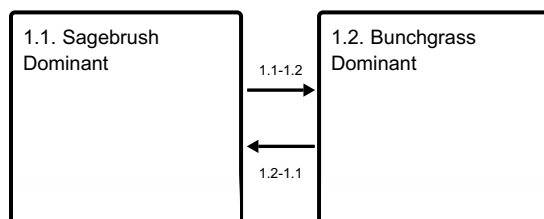

State 2 submodel, plant communities



State 3 submodel, plant communities

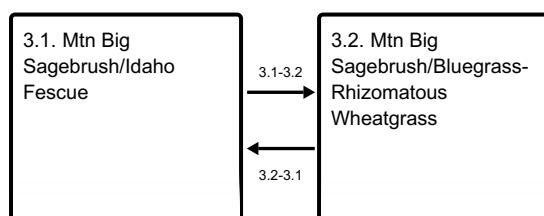

State 4 submodel, plant communities

4.1.
Rabbitbrush/Bluegrass
-Rhizomatous
Wheatgrass

**State 1
Reference State**

**Community 1.1
Sagebrush Dominant**



Figure 7. 1.1

The interpretive plant community for this site is the Reference Plant Community. This state evolved with grazing and browsing by herbivores and periodic fires. Potential vegetation is about 60% grasses or grass-like plants, 15% forbs, and 25% woody plants. This plant community can be found on areas that are properly managed with grazing and/or prescribed burning. Cool season mid-grasses dominate the site. The major grasses include Columbia and green needlegrass, spike fescue, and Idaho fescue. Mountain big sagebrush is a conspicuous element of this site. It may occur in a mosaic pattern, and makes up 10 to 15% of the annual production. Natural fire occurred in this community and prevented sagebrush from being the dominant landscape. A variety of forbs also occurs in this state and plant diversity is high (see Plant Composition Table). Annual production on this site ranges from 1050 to 1500 pounds depending on climatic conditions

Table 5. Annual production by plant type

Plant Type	Low (Kg/Hectare)	Representative Value (Kg/Hectare)	High (Kg/Hectare)
Grass/Grasslike	706	807	1009
Shrub/Vine	295	336	420
Forb	176	202	252
Total	1177	1345	1681

Table 6. Soil surface cover

Tree basal cover	0%
Shrub/vine/liana basal cover	0%
Grass/grasslike basal cover	0%
Forb basal cover	0%
Non-vascular plants	0%

Biological crusts	0%
Litter	50-70%
Surface fragments >0.25" and <=3"	0-10%
Surface fragments >3"	0-10%
Bedrock	0-5%
Water	0%
Bare ground	0-35%

Table 7. Canopy structure (% cover)

Height Above Ground (M)	Tree	Shrub/Vine	Grass/ Grasslike	Forb
<0.15	–	0%	0%	0%
>0.15 <= 0.3	–	0%	0%	0%
>0.3 <= 0.6	–	0%	0%	0%
>0.6 <= 1.4	–	0%	0%	0%
>1.4 <= 4	–	–	–	–
>4 <= 12	–	–	–	–
>12 <= 24	–	–	–	–
>24 <= 37	–	–	–	–
>37	–	–	–	–

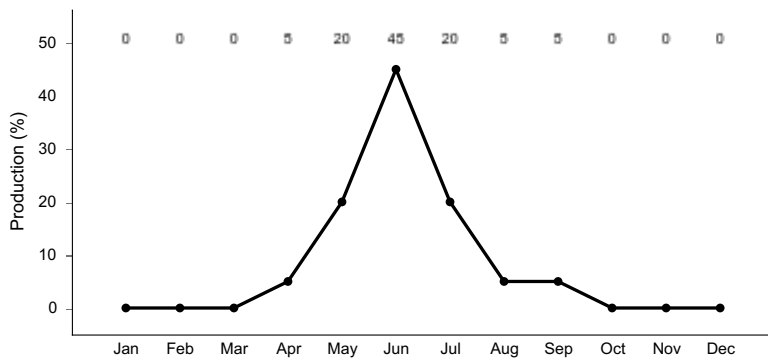

Figure 9. Plant community growth curve (percent production by month). WY1001, 15-19SE upland sites.

Community 1.2 Bunchgrass Dominant



Figure 10. 1.2

Historically, this plant community evolved following a wildfire. Currently, this site is normally found following a brush management practice or wildfire, and will revert back to the Mountain Big Sagebrush/Mixed Grass plant community if remnant stands of sagebrush remain following fire or brush management practices. The fire regime for this site has been modified and extended periods without fire are now common. Cool-season grasses make up the majority of the understory with the balance made up of miscellaneous perennial forbs. Lupine may be the dominant forb on this site. Dominant grasses include Idaho fescue, Green and Columbia needlegrass and spikefescue. Grasses of secondary importance include rhizomatous wheatgrasses, Prairie junegrass, and bluegrasses. Forbs commonly found in this plant community include agoseris, balsamroot, lupine, phlox, buckwheat, pussytoes, hawksbeard, paintbrush, and western yarrow. When compared to the Mountain Big Sagebrush/Mixed Grass Plant Community, rabbitbrush, mountain snowberry, and antelope bitterbrush may have increased. Mountain big sagebrush has decreased, often occurring only where fire or brush management treatments did not occur. Following disturbance, annual forbs may invade the site temporarily. However as herbaceous species re-establish annual forbs will decrease as long as proper grazing management is implemented.

Table 8. Annual production by plant type

Plant Type	Low (Kg/Hectare)	Representative Value (Kg/Hectare)	High (Kg/Hectare)
Grass/Grasslike	628	942	1132
Forb	135	202	247
Shrub/Vine	135	202	247
Total	898	1346	1626

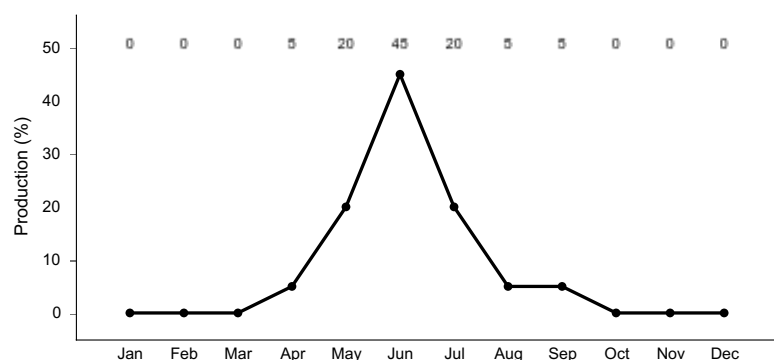
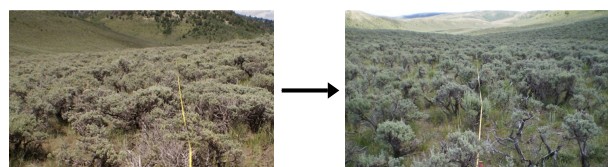

Figure 12. Plant community growth curve (percent production by month). WY1001, 15-19SE upland sites.

Pathway 1.1-1.2 Community 1.1 to 1.2



Sagebrush Dominant

Bunchgrass Dominant

Wildfire or Brush Management practices will convert this plant community to the Mixed grass/perennial forbs plant community. Prescribed fire or other brush management activities can be used to hasten this transition.

Pathway 1.2-1.1 Community 1.2 to 1.1

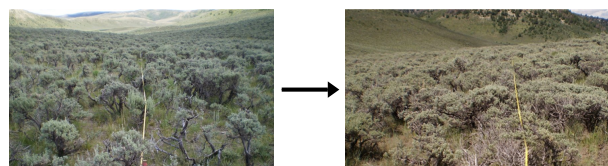

Bunchgrass Dominant

Sagebrush Dominant

Long-Term Prescribed Grazing or Natural Succession w/ No Fire or Brush Management Practices will convert the Mixed grass/perennial forbs plant community to the Mountain Big Sagebrush/Mixed Grass Plant Community in time depending on climatic conditions. The probability of this occurring is high, especially with livestock grazing by cattle. Grazing by sheep or other browsers will slow this succession.

State 2

Heavy Mtn Sagebrush State

Community 2.1

Heavy Mtn Big Sagebrush

This plant community is found in areas where wildfire or brush management practices haven't occurred in forty or more years. Mountain big sagebrush is dominant and has canopy cover of 30% to 60% or more. Cool-season grasses and perennial forbs are found in the understory, but typically make up only 20% to 40% of total production. Dominant grasses include Columbia needlegrass, green needlegrass, Lettermans' needlegrass, spikefescue, squirreltail, and Idaho fescue. Forbs commonly found in this plant community include hawksbeard, paintbrush, groundsel, buckwheat, phlox, lupine, larkspur, sneezeweed, pussytoes, and American vetch. Other brush species such as Mountain snowberry and serviceberry may exist in scattered areas, but at a lower frequency and density than plant communities where fire or brush management activities have occurred. When compared to the Mixed Grass/Mountain Big Sagebrush Plant Community, perennial forbs have decreased as less sunlight reaches the ground. Most of the preferred grasses remain in lesser amounts, and are less available for grazing. Some decadence of bunchgrasses may have occurred.

State 3

Grazing Resistant State

Community 3.1

Mtn Big Sagebrush/Idaho Fescue

This plant community is the result of Continuous Season-Long Grazing during spring and summer months. Mountain Big Sagebrush is the dominant shrub of this plant community and the annual production can exceed 50%. Canopy cover of Mountain big sagebrush is typically 15% to 40%. Preferred mid-statured cool season grasses have been greatly reduced. The interspaces between plants have expanded leaving the amount of bare ground more prevalent and more soil surface exposed to erosive elements. Idaho fescue is the dominant herbaceous species, and the bluegrasses such as Sandberg, mutton, big, bluegrass have increased. When compared with the RPC the annual production is less, as the major cool-season grasses are reduced, but the Mountain big sagebrush production has increased significantly, and other shrub species have increased.

Community 3.2

Mtn Big Sagebrush/Bluegrass-Rhizomatous Wheatgrass

This plant community currently is found under continuous season-long cattle grazing. Mid-statured cool-season bunchgrasses are not as abundant. Dominant grasses include western wheatgrass, Sandberg, mutton bluegrass and of less frequency Idaho fescue, Prairie junegrass, and spikefescue. Forbs commonly found in this plant community include balsamroot, paintbrush, phlox, groundsel, lupine, pussytoes, and Western yarrow. Rabbitbrush has increased, and can be as much as 25% of the total production.

Pathway 3.1-3.2

Community 3.1 to 3.2

Continuous Season Long Grazing without Brush Management will convert this plant community to the Mountain Big Sagebrush/Bluegrass/Western Wheatgrass Plant Community.

Pathway 3.2-3.1

Community 3.2 to 3.1

Early Spring Prescribed Grazing may lead to the Mountain Big Sagebrush/Idaho Fescue plant community. This would occur only if grazing occurred early to take advantage of bluegrass species, and deferment occurs following this short grazing period

State 4 Disturbed State

Community 4.1 Rabbitbrush/Bluegrass-Rhizomatous Wheatgrass

This plant community currently is found under heavy continuous season-long grazing by livestock and is perpetuated by either brush management or a wildfire, which removes Mountain big sagebrush from this plant community. Rabbitbrush can be significant component of this plant community, but also may be lacking, and other sprouting shrubs will typically occur. Few of the major cool-season bunchgrasses remain, and even with Long-Term Prescribed grazing a transition to the Mixed Grass/Perennial Forb State is unlikely and very long-term at best. Perennial forbs that may re-establish with cattle grazing are lupine, which can be dominant, balsamroot, groundsel, and western yarrow. Perennial forbs can be a major part of this plant community following brush management activities. Dominant grasses include rhizomatous wheatgrasses, bluegrasses, prairie junegrass, and of less frequency Idaho fescue and spike fescue. When compared to the Historical Climax Plant Community, rhizomatous wheatgrass, prairie junegrass, rubber rabbitbrush have increased. Columbia needlegrass, Idaho fescue, and Mountain big sagebrush have decreased or been removed. Production of the preferred cool-season bunchgrasses has been reduced. Some annual forbs such as alyssum can occur after disturbance, usually until the perennial species re-establish.

Transition 1.1-2 State 1 to 2

Transition 1.1 to 2 Natural Succession and no wildfire or brush management practices will lead to the heavy sagebrush plant community.

Transition 1.1-3 State 1 to 3

Transition 1.1 to 3 Moderate, continuous season-long grazing with absence of wildfire or brush management practices will convert the plant community to the Mountain big sagebrush/Idaho fescue plant community.

Transition 1.2-3 State 1 to 3

Transition 1.2 to 3 Moderate season-long grazing and no wildfire or brush management activity may eventually lead to the Mountain Big Sagebrush/Idaho fescue plant community, as decreasers such as the needlegrasses are exposed to defoliation more than once due to desirability by livestock, while Idaho fescue and other low growing species are protected from grazing by their low growth form.

Transition 1.2-4 State 1 to 4

Transition 1.2 to 4 Continuous Season-Long grazing may convert the Mixed grass/perennial forbs plant community to the rabbitbrush/bluegrass/western wheatgrass plant community.

Transition T2-3 State 2 to 3

Brush management or Wildfire with season-long grazing may convert this plant community to the rabbitbrush/western wheatgrass/bluegrass Plant Community.

Restoration pathway R3-1.1

State 3 to 1

Long-Term Prescribed grazing plus brush management may eventually convert this plant community to near RPC as long as remnant mid-statured grasses exist at adequate levels prior to improved grazing management. Seeding may be required if less than 25% of the pre-treatment herbaceous component is made up of desirable cool-season grasses and perennial forbs. If prescribed fire is used as a means to reduce or remove the shrubs, sufficient fine fuels may not be present. This scenario will require deferment from grazing prior to treatment. Post management is critical to ensure success. This can range from two or more years of rest to partial growing season deferment, depending on the condition of the understory at the time of treatment and the growing conditions following treatment.

Restoration pathway R3-2

State 3 to 2

Without Brush Management or Wildfire this plant community will eventually convert to a Heavy Sagebrush Plant Community, as Mountain big sagebrush has an advantage with only early season competition for moisture and space from herbaceous species.

Transition T3-4

State 3 to 4

Brush Management or Wildfire with Continuous Season-Long grazing Management will convert this plant community to the rabbitbrush/western wheatgrass/bluegrass Plant Community. If shrubs such as Mountain snowberry, antelope bitterbrush, and serviceberry are present in the pre-fire plant community, these species may temporarily re-establish, however, rabbitbrush and Mountain snowberry will likely be the only long-term survivors if growing season long grazing occurs.

Restoration pathway R4-3

State 4 to 3

Long-term prescribed grazing plus brush management may eventually convert this plant community to a Mountain big sagebrush/bluegrass/western wheatgrass plant community. Controlling rabbitbrush, if present, is difficult as it is a strong re-sprouter. Reestablishing big sagebrush may be difficult and may take many years.

Additional community tables

Table 9. Community 1.1 plant community composition

Group	Common Name	Symbol	Scientific Name	Annual Production (Kg/Hectare)	Foliar Cover (%)
Grass/Grasslike					
1	Perennial Mid-Size Cool Season Grasses			135–269	
	Columbia needlegrass	ACNE9	<i>Achnatherum nelsonii</i>	67–202	5–15
	green needlegrass	NAVI4	<i>Nassella viridula</i>	67–135	5–10
	bluebunch wheatgrass	PSSP6	<i>Pseudoroegneria spicata</i>	13–67	1–5
	needle and thread	HECO26	<i>Hesperostipa comata</i>	13–67	1–5
2	Rhizomatous Grasses			135–202	
	spike fescue	LEKI2	<i>Leucopoa kingii</i>	67–135	5–10
	western wheatgrass	PASM	<i>Pascopyrum smithii</i>	67–135	5–10
3	Perennial Short-Stature Grasses			135–202	
	Idaho fescue	FEID	<i>Festuca idahoensis</i>	67–135	5–10
	muttongrass	POFE	<i>Poa fendleriana</i>	27–67	2–5
	Sandberg bluegrass	POSE	<i>Poa secunda</i>	27–67	2–5

4	Misc Grasses/Grasslikes			67-135	
	Grass, perennial	2GP	<i>Grass, perennial</i>	0-67	0-5
	Letterman's needlegrass	ACLE9	<i>Achnatherum lettermanii</i>	0-67	0-5
	Ross' sedge	CARO5	<i>Carex rossii</i>	13-67	1-5
	prairie Junegrass	KOMA	<i>Koeleria macrantha</i>	13-67	1-5
	basin wildrye	LECI4	<i>Leymus cinereus</i>	0-27	0-2
	oniongrass	MEBU	<i>Melica bulbosa</i>	0-27	0-2
	California oatgrass	DACA3	<i>Danthonia californica</i>	0-27	0-2
	Montana wheatgrass	ELAL7	<i>Elymus albicans</i>	0-27	0-2
	squirreltail	ELEL5	<i>Elymus elymoides</i>	0-27	0-2
	Porter brome	BRPO2	<i>Bromus porteri</i>	0-27	0-2
	needleleaf sedge	CADU6	<i>Carex duriuscula</i>	0-27	0-2
	threadleaf sedge	CAFI	<i>Carex filifolia</i>	0-27	0-2
Forb					
5	Perennial Forbs			135-188	
	spiny phlox	PHHO	<i>Phlox hoodii</i>	0-27	0-2
	flowery phlox	PHMU3	<i>Phlox multiflora</i>	0-27	0-2
	pussytoes	ANTEN	<i>Antennaria</i>	0-27	0-2
	ballhead sandwort	ARCO5	<i>Arenaria congesta</i>	13-27	1-2
	prairie sagewort	ARFR4	<i>Artemisia frigida</i>	0-27	0-2
	milkvetch	ASTRA	<i>Astragalus</i>	0-27	0-2
	arrowleaf balsamroot	BASA3	<i>Balsamorhiza sagittata</i>	0-27	0-2
	western yarrow	ACMIO	<i>Achillea millefolium var. occidentalis</i>	13-27	1-2
	false agoseris	AGGLL	<i>Agoseris glauca var. laciniata</i>	13-27	1-2
	Indian paintbrush	CASTI2	<i>Castilleja</i>	0-27	0-2
	hawksbeard	CREPI	<i>Crepis</i>	0-27	0-2
	fleabane	ERIGE2	<i>Erigeron</i>	0-27	0-2
	buckwheat	ERIOG	<i>Eriogonum</i>	0-27	0-2
	hoary tansyaster	MACA2	<i>Machaeranthera canescens</i>	0-27	0-2
	scarlet globemallow	SPCO	<i>Sphaeralcea coccinea</i>	0-27	0-2
	stemless mock goldenweed	STAC	<i>Stenotus acaulis</i>	0-13	0-1
	hollyleaf clover	TRGY	<i>Trifolium gymnocarpon</i>	0-13	0-1
	violet	VIOLA	<i>Viola</i>	0-13	0-1
	bluebells	MERTE	<i>Mertensia</i>	0-13	0-1
	beardtongue	PENST	<i>Penstemon</i>	0-13	0-1
	desertparsley	LOMAT	<i>Lomatium</i>	0-13	0-1
	larkspur	DELPH	<i>Delphinium</i>	0-13	0-1
	onion	ALLIU	<i>Allium</i>	0-13	0-1
	sego lily	CANU3	<i>Calochortus nuttallii</i>	0-13	0-1
	sagebrush buttercup	RAGL	<i>Ranunculus glaberrimus</i>	0-13	0-1
6	Annual Forbs			0-13	
	bushy bird's beak	CORA5	<i>Cordylanthus ramosus</i>	0-13	0-1

Shrub/Mine

Shrubs					
7	Shrubs			135–269	
	mountain big sagebrush	ARTRV	<i>Artemisia tridentata ssp. vaseyana</i>	135–269	10–25
8	Misc Shrubs			0–135	
	Wyoming big sagebrush	ARTRW8	<i>Artemisia tridentata ssp. wyomingensis</i>	0–135	0–10
	rabbitbrush	CHRY9	<i>Chrysothamnus</i>	13–67	1–5
	antelope bitterbrush	PUTR2	<i>Purshia tridentata</i>	0–67	0–5
	longrunner	ROSA	<i>Rorippa sarmentosa</i>	0–67	0–5
	Saskatoon serviceberry	AMAL2	<i>Amelanchier alnifolia</i>	0–67	0–5
	western snowberry	SYOC	<i>Symphoricarpos occidentalis</i>	13–67	1–5
	Woods' rose	ROWO	<i>Rosa woodsii</i>	0–27	0–2
	granite prickly phlox	LIPU11	<i>Linanthus pungens</i>	0–27	0–2

Table 10. Community 1.2 plant community composition

Group	Common Name	Symbol	Scientific Name	Annual Production (Kg/Hectare)	Foliar Cover (%)
Grass/Grasslike					
1	Perennial Mid-Size Cool Season Grasses			202–336	
	Columbia needlegrass	ACNE9	<i>Achnatherum nelsonii</i>	67–135	5–10
	green needlegrass	NAVI4	<i>Nassella viridula</i>	67–135	5–10
	bluebunch wheatgrass	PSSP6	<i>Pseudoroegneria spicata</i>	13–67	1–5
2	Rhizomatous Grasses			67–202	
	spike fescue	LEKI2	<i>Leucopoa kingii</i>	67–135	5–10
	western wheatgrass	PASM	<i>Pascopyrum smithii</i>	67–135	5–10
3	Perennial Short-Statured Grasses			67–202	
	Idaho fescue	FEID	<i>Festuca idahoensis</i>	67–135	5–10
	muttongrass	POFE	<i>Poa fendleriana</i>	27–135	2–10
	Sandberg bluegrass	POSE	<i>Poa secunda</i>	27–67	2–5
4	Misc Grasses			67–202	
	Grass, perennial	2GP	<i>Grass, perennial</i>	0–67	0–5
	Letterman's needlegrass	ACLE9	<i>Achnatherum lettermanii</i>	0–67	0–5
	Ross' sedge	CARO5	<i>Carex rossii</i>	13–67	1–5
	prairie Junegrass	KOMA	<i>Koeleria macrantha</i>	13–67	1–5
	basin wildrye	LECI4	<i>Leymus cinereus</i>	0–27	0–2
	oniongrass	MEBU	<i>Melica bulbosa</i>	0–27	0–2
	California oatgrass	DACA3	<i>Danthonia californica</i>	0–27	0–2
	Montana wheatgrass	ELAL7	<i>Elymus albicans</i>	0–27	0–2
	squirreltail	ELEL5	<i>Elymus elymoides</i>	0–27	0–2
	needle and thread	HECO26	<i>Hesperostipa comata</i>	0–27	0–2
	Porter brome	BRPO2	<i>Bromus porteri</i>	0–27	0–2
	needleleaf sedge	CADU6	<i>Carex duriuscula</i>	0–27	0–2
	threadleaf sedge	CAFI	<i>Carex filifolia</i>	0–27	0–2
Forb					
5	Perennial Forbs			135–188	

	lupine	LUPIN	<i>Lupinus</i>	13-67	1-5
	hoary tansyaster	MACA2	<i>Machaeranthera canescens</i>	0-27	0-2
	scarlet globemallow	SPCO	<i>Sphaeralcea coccinea</i>	0-27	0-2
	pussytoes	ANTEN	<i>Antennaria</i>	0-27	0-2
	ballhead sandwort	ARCO5	<i>Arenaria congesta</i>	13-27	1-2
	prairie sagewort	ARFR4	<i>Artemisia frigida</i>	0-27	0-2
	milkvetch	ASTRA	<i>Astragalus</i>	0-27	0-2
	arrowleaf balsamroot	BASA3	<i>Balsamorhiza sagittata</i>	0-27	0-2
	western yarrow	ACMIO	<i>Achillea millefolium var. occidentalis</i>	13-27	1-2
	false agoseris	AGGLL	<i>Agoseris glauca var. laciniata</i>	13-27	1-2
	Indian paintbrush	CASTI2	<i>Castilleja</i>	0-27	0-2
	hawksbeard	CREPI	<i>Crepis</i>	0-27	0-2
	fleabane	ERIGE2	<i>Erigeron</i>	0-27	0-2
	buckwheat	ERIOG	<i>Eriogonum</i>	0-27	0-2
	spiny phlox	PHHO	<i>Phlox hoodii</i>	0-27	0-2
	flowery phlox	PHMU3	<i>Phlox multiflora</i>	0-27	0-2
	sagebrush buttercup	RAGL	<i>Ranunculus glaberrimus</i>	0-13	0-1
	desertparsley	LOMAT	<i>Lomatium</i>	0-13	0-1
	larkspur	DELPH	<i>Delphinium</i>	0-13	0-1
	pale bastard toadflax	COUMP	<i>Comandra umbellata ssp. pallida</i>	0-13	0-1
	onion	ALLIU	<i>Allium</i>	0-13	0-1
	sego lily	CANU3	<i>Calochortus nuttallii</i>	0-13	0-1
	stemless mock goldenweed	STAC	<i>Stenotus acaulis</i>	0-13	0-1
	hollyleaf clover	TRGY	<i>Trifolium gymnocarpon</i>	0-13	0-1
	violet	VIOLA	<i>Viola</i>	0-13	0-1
	bluebells	MERTE	<i>Mertensia</i>	0-13	0-1
	beardtongue	PENST	<i>Penstemon</i>	0-13	0-1
6	Annual Forbs			0-13	
	bushy bird's beak	CORA5	<i>Cordylanthus ramosus</i>	0-13	0-1
Shrub/Vine					
7	Shrubs			67-202	
	mountain big sagebrush	ARTRV	<i>Artemisia tridentata ssp. vaseyana</i>	90-135	5-10
8	Misc Shrubs			0-135	
	Wyoming big sagebrush	ARTRW8	<i>Artemisia tridentata ssp. wyomingensis</i>	0-135	0-10
	rabbitbrush	CHRY9	<i>Chrysothamnus</i>	0-67	0-5
	Saskatoon serviceberry	AMAL2	<i>Amelanchier alnifolia</i>	0-67	0-5
	antelope bitterbrush	PUTR2	<i>Purshia tridentata</i>	0-67	0-5
	mountain snowberry	SYOR2	<i>Symphoricarpos oreophilus</i>	0-67	0-5
	spineless horsebrush	TECA2	<i>Tetradymia canescens</i>	0-67	0-5
	Woods' rose	ROWO	<i>Rosa woodsii</i>	0-27	0-2
	black sagebrush	ARNO4	<i>Artemisia nova</i>	0-27	0-2
	granite prickly phlox	LIPU11	<i>Linanthus pungens</i>	0-27	0-2

Animal community

The following table lists suggested stocking rates for cattle under continuous season-long grazing under normal growing conditions. These are conservative estimates that should be used only as guidelines in the initial stages of the conservation planning process. Often, the current plant composition does not entirely match any particular plant community (as described in this ecological site description). Because of this, a field visit is recommended, in all cases, to document plant composition and production. More precise carrying capacity estimates should eventually be calculated using this information along with animal preference data, particularly when grazers other than cattle are involved. Under more intensive grazing management, improved harvest efficiencies can result in an increased carrying capacity, but recovery time for upland sites is much longer than in a low intensity system. If distribution problems occur, stocking rates must be reduced or facilitating conservation practices (i.e. cross-fencing, water development) to maintain plant health and vigor.

Plant Community Production Carrying Capacity* (lb./ac) (AUM/ac)

Sagebrush Dominate (Reference) 800-1200-1450 .20

Bunchgrass Dominate 800-1200-1450 .25

* - Continuous, season-long grazing by cattle under average growing conditions.

**Calculation for stocking rates are as follows: using RV values for production, take forage palatable to grazing cattle multiply by 0.25 harvest efficiency and divide by 912 (air dried weight) to arrive at carrying capacity.

Grazing by domestic livestock is one of the major income-producing industries in the area. Rangeland in this area may provide yearlong forage for cattle, sheep, or horses. During the dormant period, the forage for livestock use needs to be supplemented with protein because the quality does not meet minimum livestock requirements.

Distance to water, shrub density, and slope can affect grazing capacity within a management unit. Adjustments should be made for the area that is considered necessary for reduction of animal numbers. For example, 30% of a management unit may have 25% slopes and distances of greater than 1 mile from water; therefore the adjustment is only calculated for 30% of the unit (i.e. 50% reduction on 30% of the management unit). Fencing, slope length, management, access, terrain, kind and class of livestock, and breeds are all factors that can increase or decrease the percent of graze-able acres within a management unit. Adjustments should be made that incorporate these factors when calculating stocking rates.

Hydrological functions

Water is the principal factor limiting forage production on this site. This site is dominated by soils in hydrologic group B (infiltration rate of 0.15-0.3 in/hr), with localized areas in hydrologic groups A (infiltration rate of 0.3 in/hr) and C (infiltration rate of 0.05-0.15 in/hr). Infiltration ranges from rapid to moderate. Runoff potential for this site varies from low to moderate depending on soil hydrologic group and ground cover. In many cases, areas with greater than 75% ground cover have the greatest potential for high infiltration and lower runoff. Areas where ground cover is less than 50% have the greatest potential to have reduced infiltration and higher runoff (refer to Part 630, NRCS National Engineering Handbook for detailed hydrology information).

Rills and gullies should not typically be present. Water flow patterns should be barely distinguishable if at all present. Pedestals are only slightly present in association with bunchgrasses and shrubs. Litter typically falls in place, and signs of movement are not common. Chemical and physical crusts are rare to non-existent. Cryptogammic crusts are present, but only cover 1-2% of the soil surface.

Recreational uses

This site provides some limited recreational opportunities for hiking, horseback riding, bird watching, and upland game hunting. The forbs have a variety of colors and shapes that appeal to photographers. This site provides valuable open space when located in large, unfragmented landscapes.

Wood products

None

Contributors

Bryan Christensen

Approval

Kirt Walstad, 3/05/2024

Acknowledgments

Wyoming BLM
Wyoming State Lands
Wyoming Game and Fish Department
George Gamblin, WY NRCS
Mark Shirley, WY NRCS
Dan Perkins, NRCS
Andy Warren, WY BLM
Cheryl Newberry, WY BLM
Maureen Hartshorn, WY BLM
Mike Henn, WY State Lands

Rangeland health reference sheet

Interpreting Indicators of Rangeland Health is a qualitative assessment protocol used to determine ecosystem condition based on benchmark characteristics described in the Reference Sheet. A suite of 17 (or more) indicators are typically considered in an assessment. The ecological site(s) representative of an assessment location must be known prior to applying the protocol and must be verified based on soils and climate. Current plant community cannot be used to identify the ecological site.

Author(s)/participant(s)	Bryan Christensen George Gamblin
Contact for lead author	Bryan Christensen MLRA 34A SSO 1625 W Pine Street Pinedale, WY 82941 307-367-2257 bryan.christensen@wy.usda.gov
Date	03/25/2015
Approved by	Kirt Walstad
Approval date	
Composition (Indicators 10 and 12) based on	Annual Production

Indicators

1. **Number and extent of rills:** Rare to nonexistent. Where present, short and widely spaced.
-

2. **Presence of water flow patterns:** Barely observable
-

3. **Number and height of erosional pedestals or terracettes:** Rare to nonexistent

4. **Bare ground from Ecological Site Description or other studies (rock, litter, lichen, moss, plant canopy are not bare ground):** Bare ground can range from 0-20%

5. **Number of gullies and erosion associated with gullies:** Active gullies should not be present

6. **Extent of wind scoured, blowouts and/or depositional areas:** Rare to nonexistent

7. **Amount of litter movement (describe size and distance expected to travel):** Herbaceous and large woody litter not expected to move.

8. **Soil surface (top few mm) resistance to erosion (stability values are averages - most sites will show a range of values):** Soil Stability Index ratings range from 3 (interspaces) to 6 (under plant canopy), but average values should be 4.0 or greater.

9. **Soil surface structure and SOM content (include type of structure and A-horizon color and thickness):** Soil data is limited for this site. Described A-horizons vary from 6-23 inches (15-58 cm) with OM of 2 to 5%.

10. **Effect of community phase composition (relative proportion of different functional groups) and spatial distribution on infiltration and runoff:** Plant community consists of 60% grasses, 15% forbs, and 25% shrubs. Evenly distributed plant canopy (60-95%) and litter plus moderate infiltration rates result in minimal runoff. Basal cover is typically 5-15% for this site and does affect runoff on this site.

11. **Presence and thickness of compaction layer (usually none; describe soil profile features which may be mistaken for compaction on this site):** None

12. **Functional/Structural Groups (list in order of descending dominance by above-ground annual-production or live foliar cover using symbols: >>, >, = to indicate much greater than, greater than, and equal to):**

Dominant: Mid-size, cool season bunchgrasses

Sub-dominant: perennial shrubs=perennial forbs>tall, cool season bunchgrasses>cool season rhizomatous grasses=short cool season bunchgrasses

Other:

Additional:

13. **Amount of plant mortality and decadence (include which functional groups are expected to show mortality or decadence):** Minimal decadence, typically associated with shrub component

14. **Average percent litter cover (%) and depth (in):** Litter ranges from 50-70% of total canopy measurement with total litter (including beneath the plant canopy) from 50-90% expected. Herbaceous litter depth typically ranges from 5-15mm. Woody litter can be up to a couple inches (4-6 cm).

15. **Expected annual annual-production (this is TOTAL above-ground annual-production, not just forage annual-production):** English: 1050-1500 lb/ac (1200 lb/ac average); Metric 1176-1681 kg/ha (1345 kg/ha average)

16. **Potential invasive (including noxious) species (native and non-native). List species which BOTH characterize degraded states and have the potential to become a dominant or co-dominant species on the ecological site if their future establishment and growth is not actively controlled by management interventions. Species that become dominant for only one to several years (e.g., short-term response to drought or wildfire) are not invasive plants. Note that unlike other indicators, we are describing what is NOT expected in the reference state for the ecological site:** Bare ground greater than 30% is the most common indicator of a threshold being crossed. Big sagebrush, rubber rabbitbrush, and bluegrasses are common increasers. Kentucky bluegrass, common dandelion, thistles, and annual weeds such as kochia and mustards are common invasive species in disturbed sites.

17. **Perennial plant reproductive capability:** All species are capable of reproducing, except in extreme drought years
