

Ecological site R048BY291CO

Loamy Glacial Outwash

Last updated: 9/07/2023
Accessed: 05/12/2024

General information

Provisional. A provisional ecological site description has undergone quality control and quality assurance review. It contains a working state and transition model and enough information to identify the ecological site.

MLRA notes

Major Land Resource Area (MLRA): 048B–Southern Rocky Mountain Parks and Valleys

This area is in Colorado (96 percent) and Wyoming (4 percent). It makes up about 2,325 square miles (6,020 square kilometers). The town of Walden, in the northern part of this MLRA, is in a wide valley locally known as North Park. The town of Kremmling is in a valley locally known as Middle Park. The town of Hartsel, in the center of the southern part of the MLRA, is in a broad intermontane basin locally known as South Park. The northern part is bordered by the Medicine Bow, Routt, and Arapaho National Forests, and the southern part is bordered by the San Isabel and Pike National Forests. The Arapaho National Wildlife Refuge is directly south of the town of Walden.

This area is within the Southern Rocky Mountains Province of the Rocky Mountain System. It consists of nearly level to rolling mountain parks and valleys and a few narrow mountain ridges. It occurs as two separate parts in the center of the Southern Rockies. The southern half of the northern part is on the west side of the Continental Divide, and the rest of the MLRA is on the east side of the divide. Elevation ranges from 7,850 to 10,850 feet (2,395 to 3,310 meters). The head waters of North Platte River leaves Colorado and enters Wyoming in the northern half of the northern part of the MLRA (North Park). The headwaters of Colorado River is in the southern half of the northern part of the MLRA (Middle Park). The headwaters of South Platte River is in the southern part of the MLRA (South Park).

The mountain valleys and parks that are characteristic of this MLRA are surrounded by high mountain peaks of the adjacent Southern Rocky Mountains MLRA (48A). Steep slopes give rise to steep-gradient streams that can move cobbles and gravel from the mountain slopes down into the valleys. The coarse textured sediments on the surface of this area were deposited by either glacial meltwater or present-day rivers. Buried deep beneath the sediments is a complex of sedimentary and igneous rocks. Residuum from sedimentary rocks is on the steeper slopes that were not covered by alluvium and glacial outwash.

The average annual precipitation is mainly 10 to 16 inches (255 to 405 millimeters), but it is as high as 28 inches (710 millimeters) at the higher elevations that border the Southern Rocky Mountains MLRA. Precipitation generally increases with elevation. Rainfall occurs as high-intensity, convective thunderstorms during the growing season. About half of the annual precipitation falls as snow. Soil moisture is unevenly distributed within short distances because of snowdrifts. The amount of precipitation is highly influenced by rain shadows. The surrounding peaks receive most of the precipitation as storm systems traverse the area. The average annual temperature is 35 to 42 degrees F (1 to 6 degrees C). The freeze-free period averages 95 days and ranges from 70 to 120 days, decreasing in length with elevation.

The dominant soil order in this MLRA is Mollisols. Alfisols are of lesser extent. The soils are very shallow to deep, generally well drained, and loamy or clayey and have mixed or smectitic mineralogy. The soil temperature regime is dominantly cryic, but it is frigid in some small areas, primarily on south- or west-facing slopes. The soil moisture regime is mainly ustic, but a marginal aridic regime has been identified in areas where the average annual precipitation is less than about 12 inches (305 millimeters). The most extensive great group is Argicryolls (Hodden, Lucky, Parlin, Tiagos, and Cabin series), which commonly formed in outwash and slope alluvium on outwash

terraces, fan remnants, hills, and mountain slopes. Haplocryolls (Redcloud and Tealson series) formed in outwash and slope alluvium on outwash terraces, valley side slopes, hills, and ridges. Haplocryalfs (Gebson and Harsha series) formed in slope alluvium and outwash on outwash terraces, fan remnants, hills, ridges, and mountain slopes. Cryaquolls (Dobrow and Randman series) formed in alluvium on stream terraces and flood plains.

Classification relationships

NRCS:

Major Land Resource Area 48B, Southern Rocky Mountain Parks (United States Department of Agriculture, Natural Resources Conservation Service, 2006).

USFS:

M331I – North Parks and Ranges Section Southern Rocky Mountain Steppe - Open Woodland - Coniferous Forest - Alpine Meadow

EPA:

21i – Sagebrush Parks and 21j – Grassland Parks < 21 Southern Rockies < 6.2 Western Cordillera < 6 Northwestern Forested Mountains North American Deserts (Griffith, 2006).

USGS: Southern Rocky Mountain Province

Ecological site concept

R048BY291CO Loamy Glacial Outwash occurs on fans and terraces. Slopes is between one to 45 percent. Soils are moderately deep to deep (20 to 60 inches). Soils are derived from outwash. Soil surface texture is usually very cobbly sandy loam, extremely cobbly sandy loam, very gravelly sandy loam or gravelly loam with loamy-skeletal textured subsurface. It is a Gambel's oak – Arizona fescue – muttongrass community. It has a typic ustic moisture regime. The effective precipitation ranges from 14 to 18 inches.

Similar sites

R048BY237CO	<p>Stony Loam R048BY237CO Stony Loam occurs on mountain-slopes, ridges, fans and moraines. Slopes is between 20 to 70%. Soils are very deep (60+ inches). Soils are derived from till; colluvium from igneous and metamorphic rock; or residuum from igneous and metamorphic rock. Soil surface texture is usually stony loam, cobbly loam, extremely stony sandy loam, gravelly sandy loam, very gravelly sandy loam, or very cobbly sandy loam with loamy-skeletal textured subsurface. It is a bluebunch wheatgrass – needlegrass community.</p>
R048AY311CO	<p>Mountain Outwash R048AY311CO Mountain Outwash occurs on fan terraces, alluvial fans, and glacial moraines. Slopes are between 3 to 45%. Soils are deep (60+ inches). Soils are derived from alluvium that is coarse-textured and stony or cobbly. Soil surface texture is gravelly sandy loam or cobbly sandy loam with sandy-skeletal textured subsurface. It is an Arizona fescue – mountain muhly community. It has a typic ustic moisture regime and frigid temperature regime. The effective precipitation ranges from 16 to 20 inches.</p>
R048AY316CO	<p>Dry Mountain Outwash R048AY316CO Dry Mountain Outwash occurs on fan terraces and alluvial fans. Slopes is between 1 to 45%. Soils are deep (60+ inches). Soils are derived from alluvium or outwash. Soil surface texture is gravelly sandy loam with sandy-skeletal textured subsurface. It is a prairie Junegrass – pine needlegrass community. It has an aridic ustic moisture regime and frigid temperature regime. The effective precipitation ranges from 12 to 16 inches.</p>
R048AY377CO	<p>Skeletal Loam R048BY377CO Skeletal Loam occurs on hills, mountains, mountainsides, fan terraces, pediments, outwash terrace and mesas. Slopes is between 5 to 55%. Soils are deep to very deep (40 to 60+ inches). Soils are derived from slope alluvium from conglomerate, sandstone, trachyte, or volcanic breccia; outwash; colluvium from volcanic rock, trachyte, or volcanic breccia or residuum from volcanic rock. Soil surface texture is usually very gravelly loam. gravelly loam, very cobbly loam or very gravelly sandy loam with loamy-skeletal or clayey skeletal textured subsurface. It is an Arizona fescue – Parry's oatgrass community. It has an aridic ustic moisture regime. The effective precipitation ranges from 14 to 16 inches.</p>

Table 1. Dominant plant species

Tree	Not specified
Shrub	(1) <i>Quercus gambelii</i>
Herbaceous	(1) <i>Festuca arizonica</i> (2) <i>Poa fendleriana</i>

Physiographic features

This site is on moderately steep terraces (one to 45 percent) and fans formed in alluvium and glacial outwash material on the eastern slopes of the Sangre de Cristo Mountains. Elevation ranges from 7300 to 8700 feet.

Table 2. Representative physiographic features

Landforms	(1) Fan (2) Terrace
Flooding frequency	None
Ponding frequency	None
Elevation	2,225–2,652 m
Slope	1–45%
Aspect	Aspect is not a significant factor

Climatic features

The climate is semi-arid with precipitation averaging 14 to 18 inches. The mean growing season averages approximately 65 to 90 days from June 10 to September 30. In average years, there is sufficient moisture at the beginning of the growing season to initiate growth in such cool-season grasses as western wheatgrass, muttongrass, needle and thread, mountain muhly, and bottlebrush squirreltail. Their optimum growing season is early May through July. The warm season grasses, such as blue grama and little bluestem, have their optimum growing season from July through August, if adequate moisture is available. About 50% of the annual precipitation falls in the form of rain during the frost free season. There are 2 days per year that the precipitation equals or exceeds 1.0 inch, 7 days meet, equal or exceed 0.5 inch and 41 days that equal or exceed 0.1 inch.

The average annual temperature is 42 degrees F, with one day higher than 90 degrees F and 35 days lower than zero degrees F.

Temperatures fall below the freezing mark much of the time in September through March. Dates of 32 degrees F have occurred as late as June 10 in the spring.

Table 3. Representative climatic features

Frost-free period (characteristic range)	21-52 days
Freeze-free period (characteristic range)	62-86 days
Precipitation total (characteristic range)	381 mm
Frost-free period (actual range)	8-55 days
Freeze-free period (actual range)	51-87 days
Precipitation total (actual range)	356-381 mm
Frost-free period (average)	35 days
Freeze-free period (average)	73 days
Precipitation total (average)	381 mm

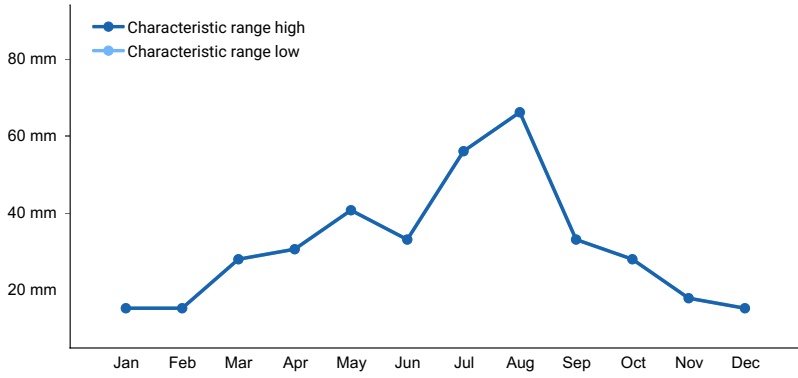

Figure 1. Monthly precipitation range

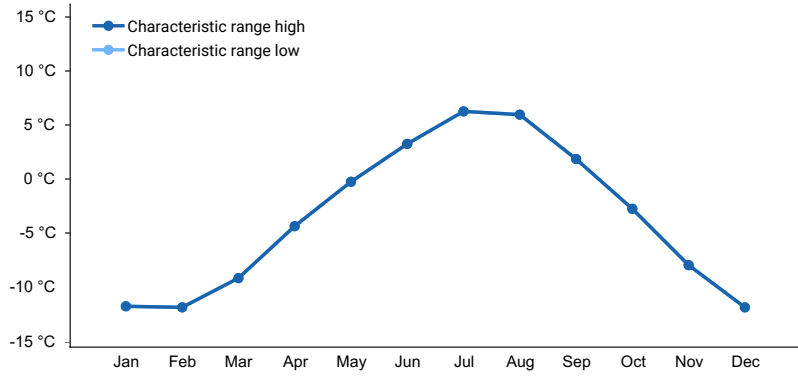

Figure 2. Monthly minimum temperature range

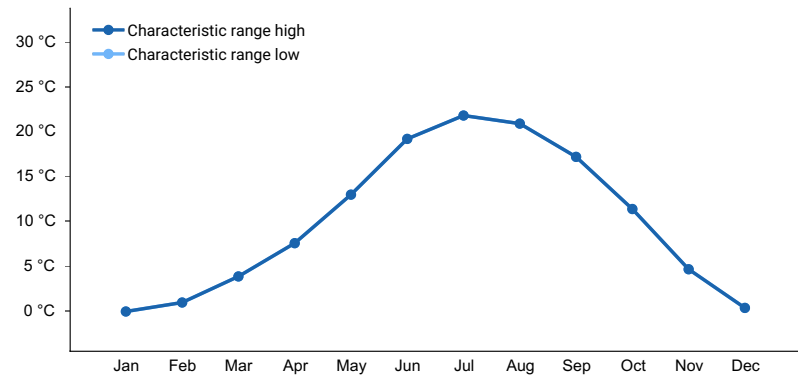

Figure 3. Monthly maximum temperature range

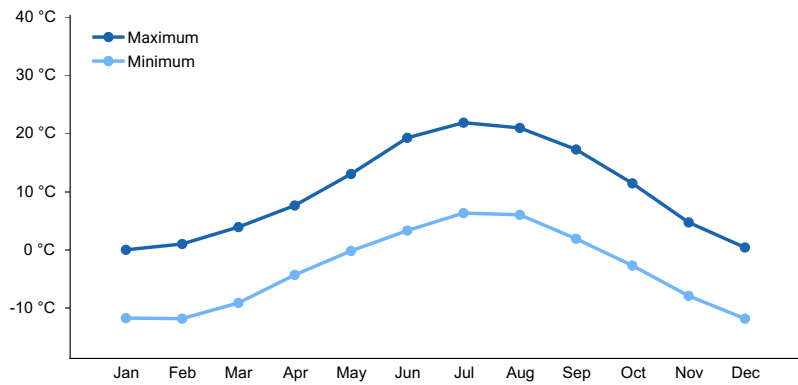

Figure 4. Monthly average minimum and maximum temperature

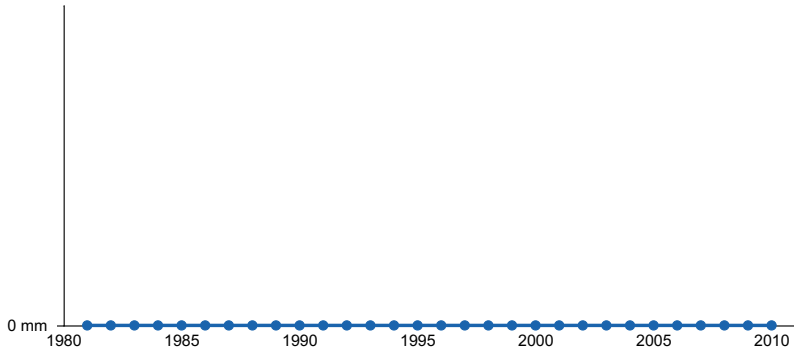

Figure 5. Annual precipitation pattern

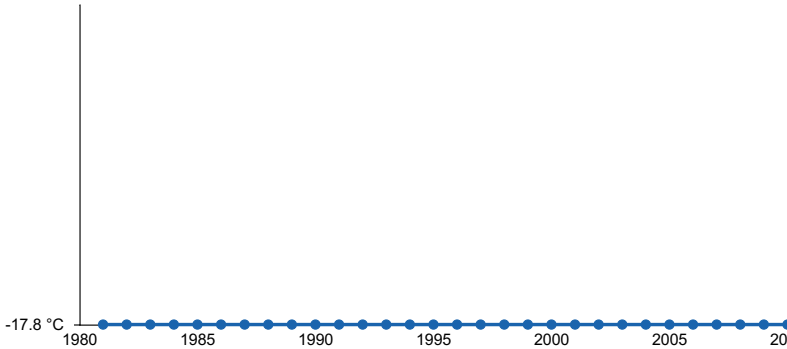

Figure 6. Annual average temperature pattern

Climate stations used

- (1) FAIRPLAY S PARK RD [USC00052816], Fairplay, CO

Influencing water features

None

Wetland description

N/A

Soil features

The soils are moderately deep to deep; very cobbly sandy loam which have developed on terraces and fans from glacial outwash. The surface typically contains over 35 percent rock fragments greater than three inches in diameter. However there are many areas where the top two or three inches of soil have very few rock fragments. Water intake rates are very rapid, and soils are excessively well drained with poor water holding capacity.

Major Soils associated with this site:

Soil Name Surface Texture Slope Range

- Alvarado CBV-SL 2-5%
- Becks GR-L 1-5%
- Cabin GR-SL 9-25%
- Curecanti GR-SL 4-25%
- Curecanti GRV-SL 4-25%
- Libeg CBV-SL 5-20%
- Norrison CBV-SL 2-25%
- Norrison CBX-SL 2-25%
- Pierian GR-SL 1-5%
- Poncha GR-SL 3-45%

Table 4. Representative soil features

Parent material	(1) Outwash
Surface texture	(1) Very cobbly, extremely cobbly, very gravelly sandy loam (2) Gravelly loam
Family particle size	(1) Loamy-skeletal
Drainage class	Well drained
Soil depth	51–152 cm

Ecological dynamics

The potential plant community is dominantly grasses interspersed with a few shrubs and forbs. The plant community is about 75 percent grasses, 10 percent forbs, and 15 percent shrubs air-dry weight.

Dominant grasses are Arizona fescue, mutton grass, mountain muhly, and western wheatgrass. Less abundant grasses include blue grama, bottlebrush squirreltail, needle-and-thread, and little bluestem. Dominant forbs include Nebraska lupine and Louisiana sagewort. Numerous other forb species occur in minor amounts. Shrubs that occur on this site include Howards rabbitbrush, yellow (small) rabbitbrush, threadleaf rubber rabbitbrush, spineless (gray) horsebrush, Fendler ceanothus, and small soapweed. Half-shrubs include fringed sagewort, toadflax, penstemon, and broom snakeweed.

State and transition model

Loamy Glacial Outwash R048BY291CO

1. Reference State

1.1 Grassland

Grassland (Arizona Fescue, mountain muhly, western wheatgrass, muttongrass)

Sparse shrub component (Gambel's oak)

1.2 Grassland with Shrubs

Mixed grasses (blue grama, squirreltail, western wheatgrass, slimstem muhly)

Mixed Shrubs (Gambel's oak, rabbitbrush, skunkbush)

1.2A

1.1A

R2A

T1A

2. Seeded State

2.1 Seeded Grassland

Seeded Grassland with sparse shrubs

2.2 Seeded Grassland with Shrubs

Seeded Grassland with mixed Shrubs

2.2A

2.1A

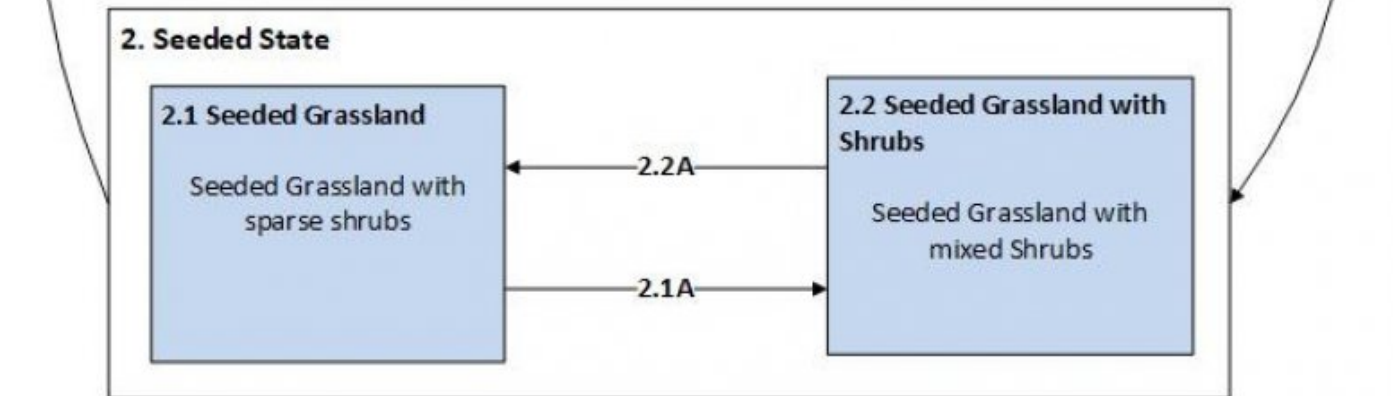

Legend

1.1A, 2.1A – lack of fire, time without disturbance and improper grazing
 1.2A, 2.2A – fire, insect herbivory, browsing of shrubs, and/or drought

T1A – Seeding

R2A – natives reestablished over extended time periods

State 1

Reference State

If ecological retrogression is cattle-induced, desirable grasses will decrease. However, if retrogression is sheep-induced, desirable forbs and shrubs may be reduced. Deterioration of this site caused by continuous grazing by cattle will decrease the percentage of grasses such as Canada bluegrass, muttongrass, needle and thread, Arizona fescue, little bluestem, elk sedge, western wheatgrass and mountain muhly. With the decrease of these plants; blue grama, bottlebrush squirreltail, slimstem muhly, and sun sedge will increase initially along with yellow (small) rabbitbrush, Howard's rabbitbrush, broom snakeweed, and fringed sagewort. Forbs, half-shrubs and shrubs likely to increase include oak brush, granite gilia, northwestern cinquefoil, rose pussytoes, white sagebrush (Louisiana sagewort), and Nebraska lupine. Continued overgrazing will reduce blue grama, needle and thread, and bottlebrush squirreltail, and further increase slimstem muhly, sun sedge, and less preferred forbs and shrubs. Plant species likely to invade include Kentucky bluegrass, cheatgrass, flannel mullein, sleepygrass, cryptantha, and prickly pear cactus. Basal area (the area of ground surface covered by the perennial vegetation measured one inch above the soil) is approximately 15 percent.

Community 1.1

Reference State

Table 5. Annual production by plant type

Plant Type	Low (Kg/Hectare)	Representative Value (Kg/Hectare)	High (Kg/Hectare)
Grass/Grasslike	504	673	841
Shrub/Vine	101	135	168
Forb	67	90	112
Total	672	898	1121

Additional community tables

Table 6. Community 1.1 plant community composition

Group	Common Name	Symbol	Scientific Name	Annual Production (Kg/Hectare)	Foliar Cover (%)
Grass/Grasslike					
1	Grasses			504–841	
	Arizona fescue	FEAR2	<i>Festuca arizonica</i>	45–179	–
	muttongrass	DOFF	<i>Poa fendleriana</i>	45–90	

	mountain grass	FOLE	<i>Poa tenuiflora</i>	45-90	-
	mountain muhly	MUMO	<i>Muhlenbergia montana</i>	45-90	-
	western wheatgrass	PASM	<i>Pascopyrum smithii</i>	45-90	-
	needle and thread	HECO26	<i>Hesperostipa comata</i>	6-56	-
	blue grama	BOGR2	<i>Bouteloua gracilis</i>	17-45	-
	prairie Junegrass	KOMA	<i>Koeleria macrantha</i>	17-45	-
	Canada bluegrass	POCO	<i>Poa compressa</i>	17-45	-
	Indian ricegrass	ACHY	<i>Achnatherum hymenoides</i>	17-45	-
	squirreltail	ELEL5	<i>Elymus elymoides</i>	17-45	-
	Geyer's sedge	CAGE2	<i>Carex geeyeri</i>	17-45	-
	sun sedge	CAINH2	<i>Carex inops ssp. heliophila</i>	0-17	-
	mountain rush	JUARL	<i>Juncus arcticus ssp. littoralis</i>	0-6	-
	slimstem muhly	MUFI	<i>Muhlenbergia filiculmis</i>	0-6	-
Forb					
2	Forbs			56-123	
	Nebraska lupine	LUPL	<i>Lupinus plattensis</i>	11-45	-
	white sagebrush	ARLU	<i>Artemisia ludoviciana</i>	11-22	-
	Lewis flax	LILE3	<i>Linum lewisii</i>	0-22	-
	bastard toadflax	COUM	<i>Comandra umbellata</i>	0-22	-
	common yarrow	ACMI2	<i>Achillea millefolium</i>	0-11	-
	textile onion	ALTE	<i>Allium textile</i>	0-11	-
	trailing fleabane	ERFL	<i>Erigeron flagellaris</i>	0-11	-
	Fremont's geranium	GECAF	<i>Geranium caespitosum var. fremontii</i>	0-11	-
	mountain goldenbanner	THMOM3	<i>Thermopsis montana var. montana</i>	0-11	-
	Front Range beardtongue	PEVI3	<i>Penstemon virens</i>	0-11	-
	sulphur-flower buckwheat	ERUM	<i>Eriogonum umbellatum</i>	0-11	-
	slender cinquefoil	POGR9	<i>Potentilla gracilis</i>	0-11	-
	Drummond's milkvetch	ASDR3	<i>Astragalus drummondii</i>	0-11	-
	hairy false goldenaster	HEVI4	<i>Heterotheca villosa</i>	0-11	-
	pingue rubberweed	HYRI	<i>Hymenoxys richardsonii</i>	0-11	-
	rosy pussytoes	ANRO2	<i>Antennaria rosea</i>	0-11	-
	common starlily	LEMO4	<i>Leucocrinum montanum</i>	0-11	-
	sidebells penstemon	PESE11	<i>Penstemon secundiflorus</i>	0-11	-
	scarlet gilia	IPAG	<i>Ipomopsis aggregata</i>	0-11	-
	northwestern Indian paintbrush	CAAND	<i>Castilleja angustifolia var. dubia</i>	0-11	-
	hairy clematis	CLHI	<i>Clematis hirsutissima</i>	0-11	-
	winged buckwheat	ERAL4	<i>Eriogonum alatum</i>	0-11	-
Shrub/Vine					
3	Shrubs			90-179	
	Gambel oak	QUGA	<i>Quercus gambelii</i>	45-90	-
	granite prickly phlox	LIPU11	<i>Linanthus pungens</i>	11-45	-
	prairie sagewort	ARFR4	<i>Artemisia frigida</i>	17-28	-

Common Name	Code	Scientific Name	Height	Notes
Parry's rabbitbrush	ERPAH	<i>Ericameria parryi</i> var. <i>howardii</i>	11-22	-
yellow rabbitbrush	CHVIS5	<i>Chrysothamnus viscidiflorus</i> ssp. <i>viscidiflorus</i> var. <i>stenophyllus</i>	11-22	-
slender buckwheat	ERMI4	<i>Eriogonum microthecum</i>	11-22	-
toadflax penstemon	PELIC	<i>Penstemon linarioides</i> ssp. <i>coloradoensis</i>	11-22	-
skunkbush sumac	RHTR	<i>Rhus trilobata</i>	11-22	-
rubber rabbitbrush	ERNAO	<i>Ericameria nauseosa</i> ssp. <i>consimilis</i> var. <i>oreophila</i>	0-11	-
Fendler's ceanothus	CEFE	<i>Ceanothus fendleri</i>	0-11	-
spineless horsebrush	TECA2	<i>Tetradymia canescens</i>	0-11	-
soapweed yucca	YUGL	<i>Yucca glauca</i>	0-11	-
broom snakeweed	GUSA2	<i>Gutierrezia sarothrae</i>	0-11	-
alderleaf mountain mahogany	CEMO2	<i>Cercocarpus montanus</i>	0-11	-
Apache plume	FAPA	<i>Fallugia paradoxa</i>	0-11	-

Animal community

Native Animal Community Associated with the Potential Plant Community:

This range site provides habitats which support a resident animal community that is characterized by antelope, small mammals, non-game birds, and an occasional coyote, elk, or deer. Elk may use the site extensively for winter range or transitional range between summer and winter range.

Livestock Grazing:

There are a variety of grasses and shrubs that provide good nutrition for grazing animals. Continuous early grazing each spring by cattle will cause western wheatgrass, needle-and-thread, and other early spring grasses to be replaced by warm-season grasses such as blue grama, or unpalatable grasses such as slimstem muhly or mat muhly. A system of deferred grazing, which varies the season of grazing use in pastures during successive years, is needed to maintain a healthy well-balanced plant community. Rest during different seasons of the year benefits different plants. Summer rest during July or August would benefit warm-season plants such as Little bluestem or blue grama. Spring rest from April through July benefits cool-season plants such as needle-and-thread, Arizona fescue western wheatgrass, mountain muhly, muttongrass, canada bluegrass and elk sedge.

Wildlife Values

This site provides good habitat and food for deer and antelope, which declines only slightly with ecological retrogression. It has high value for elk winter range. As ecological condition decreases, however, value for elk winter range decreases rapidly.

Hydrological functions

Soils in this site are grouped into "A" & "B" hydro logic groups, as outlined in the Soils of Colorado Loss Factors and Erodibility Hydrologic Groupings handbook. Field investigations are needed to determine hydrologic cover conditions. Refer to Peak Flows in Colorado handbook, and NRCS National Engineering Handbook, Section 4, for hydrologic curve numbers in determining runoff quantities.

Recreational uses

Recreation uses on this site are minor. Limited antelope hunting may occur. The site is somewhat colorful during spring when forbs are in bloom.

Wood products

No potential on this site.

Other information

This ecological site grades into an unwritten site which might be called a "Wet Mountain Outwash " which has a seasonal water table and has sedges, rushes, and other meadow vegetation. This wetter site is carried as Mountain Outwash in the Custer County Soil Survey.

The mountain outwash site in Gunnison and Saguache counties on the west slope of the Sangre de Cristo Mountains and other mountain ranges differs in that mountain big sagebrush is present and usually is lacking in oakbrush in this Loamy Glacial Outwash site.

Inventory data references

Five miles west of Westcliffe, Colorado just north of Taylor Creek.

Counties Occurring in:

Fremont, and Custer

Other references

Chapman, S.S., G.E. Griffith, J.M. Omernik, A.B. Price, J. Freeouf, and D.L. Schrupp. 2006. Ecoregions of Colorado. (2-sided color poster with map, descriptive text, summary tables, and photographs). U.S. Geological Survey, Reston, VA. Scale 1:1,200,000.

Cleland, D.T.; Freeouf, J.A.; Keys, J.E.; Nowacki, G.J.; Carpenter, C.A.; and McNab, W.H. 2007. Ecological Subregions: Sections and Subsections for the conterminous United States. Gen. Tech. Report WO-76D [Map on CD-ROM] (A.M. Sloan, cartographer). Washington, DC: U.S. Department of Agriculture, Forest Service, presentation scale 1:3,500,000; colored.

Soil Conservation Service (SCS). November 1987. Range Site Description for Loamy Glacial Outwash #291. : USDA, Denver Colorado.

United States Department of Agriculture, Natural Resources Conservation Service. 2006. Land Resource Regions and Major Land Resource Areas of the United States, the Caribbean, and the Pacific Basin. U.S. Department of Agriculture Handbook 296.

Western Regional Climate Center. Retrieved from <http://www.wrcc.dri.edu/summary/Climsmco.html> on December 10, 2018

Contributors

Suzanne Mayne-Kinney

Approval

Kirt Walstad, 9/07/2023

Acknowledgments

Project Staff:

Suzanne Mayne-Kinney, Ecological Site Specialist, NRCS MLRA, Grand Junction SSO
Chris Fabian, MLRA Soil Survey Leader, NRCS MLRA Fort Collins SSO

Program Support:

Rachel Murph, NRCS CO State Rangeland Management Specialist, Denver
Scott Woodhall, NRCS MLRA Ecological Site Specialist-QA Phoenix, AZ
Eva Muller, Regional Director, Rocky Mountain Regional Soil Survey Office, Bozeman, MT

B.J. Shoup, CO State Soil Scientist, Denver
Eugene Backhaus, CO State Resource Conservationist, Denver

Those involved in developing earlier versions of this site description include: Bob Rayer, retired NRCS Soil Scientist; Herman Garcia, retired CO State RMS and NRCS MLRA Ecological Site Specialist-QA Phoenix, AZ.

--Site Development and Testing Plan--:

Future work to validate and further refine the information in this Provisional Ecological Site Description is necessary. This will include field activities to collect low-, medium-, and high-intensity sampling, soil correlations, and analysis of that data.

Additional information and data is required to refine the Plant Production and Annual Production tables for this ecological site. The extent of MLRA 48A must be further investigated.

Field testing of the information contained in this Provisional ESD is required. As this ESD is moved to the Approved ESD level, reviews from the technical team, quality control, quality assurance, and peers will be conducted.

Rangeland health reference sheet

Interpreting Indicators of Rangeland Health is a qualitative assessment protocol used to determine ecosystem condition based on benchmark characteristics described in the Reference Sheet. A suite of 17 (or more) indicators are typically considered in an assessment. The ecological site(s) representative of an assessment location must be known prior to applying the protocol and must be verified based on soils and climate. Current plant community cannot be used to identify the ecological site.

Author(s)/participant(s)	
Contact for lead author	
Date	05/12/2024
Approved by	Kirt Walstad
Approval date	
Composition (Indicators 10 and 12) based on	Annual Production

Indicators

1. **Number and extent of rills:**

2. **Presence of water flow patterns:**

3. **Number and height of erosional pedestals or terracettes:**

4. **Bare ground from Ecological Site Description or other studies (rock, litter, lichen, moss, plant canopy are not bare ground):**

5. **Number of gullies and erosion associated with gullies:**

6. **Extent of wind scoured, blowouts and/or depositional areas:**

7. **Amount of litter movement (describe size and distance expected to travel):**

8. **Soil surface (top few mm) resistance to erosion (stability values are averages - most sites will show a range of values):**

9. **Soil surface structure and SOM content (include type of structure and A-horizon color and thickness):**

10. **Effect of community phase composition (relative proportion of different functional groups) and spatial distribution on infiltration and runoff:**

11. **Presence and thickness of compaction layer (usually none; describe soil profile features which may be mistaken for compaction on this site):**

12. **Functional/Structural Groups (list in order of descending dominance by above-ground annual-production or live foliar cover using symbols: >>, >, = to indicate much greater than, greater than, and equal to):**

Dominant:

Sub-dominant:

Other:

Additional:

13. **Amount of plant mortality and decadence (include which functional groups are expected to show mortality or decadence):**

14. **Average percent litter cover (%) and depth (in):**

15. **Expected annual annual-production (this is TOTAL above-ground annual-production, not just forage annual-production):**

16. **Potential invasive (including noxious) species (native and non-native). List species which BOTH characterize degraded states and have the potential to become a dominant or co-dominant species on the ecological site if their future establishment and growth is not actively controlled by management interventions. Species that become dominant for only one to several years (e.g., short-term response to drought or wildfire) are not invasive plants. Note that unlike other indicators, we are describing what is NOT expected in the reference state**

for the ecological site:

17. **Perennial plant reproductive capability:**
