

# Ecological site R056BY084MN

## Clayey

Last updated: 9/04/2024  
 Accessed: 09/27/2024

---

### General information

**Provisional.** A provisional ecological site description has undergone quality control and quality assurance review. It contains a working state and transition model and enough information to identify the ecological site.

### MLRA notes

Major Land Resource Area (MLRA): 056B–Glacial Lake Agassiz, Tallgrass Aspen Parklands

MLRA 56B is part of the glacial Lake Agassiz basin, which formed as the lake receded. Most of the area is glaciolacustrine sediments overlying till. This MLRA is entirely in Minnesota and makes up about 4,664 square miles (12,079 square kilometers). It is bordered by beaches and a lake plain on the west (MLRA 56A), by a till plain on the south (MLRA 102A), and by a lake plain and till plain on the east (MLRA 88) (United States Department of Agriculture, Agriculture Handbook 296, 2022).

### Classification relationships

Level IV Ecoregions of the Conterminous United States: 48a Glacial Lake Agassiz Basin; 48b Beach Ridges and Sand Deltas; and 48d Lake Agassiz Plains.

MLRA 56B (United States Department of Agriculture, Agriculture Handbook 296, 2022).

### Ecological site concept

The Clayey ecological site typically is located on flats and rises on lake plains, delta plains, and ground moraines; it also occurs on side slopes of drainageways and on natural levees along major streams and rivers. The soils are very deep. The dark-colored surface soil is more than 7 inches thick (>20 inches in some soils). Surface textures are silty clay, clay, silty clay loam, clay loam, or loam. Subsoil textures typically are clay or silty clay, although clay loam and silty clay loam textures with >35% clay also occur. The subsoil forms a ribbon >2 inches long. Soil on this site is poorly drained or well drained. Generally, calcium carbonate does not occur in the surface and upper subsoil layers; however, very slight to slight effervescence is allowable. Slopes range from 0 to 5 percent. On the landscape, this site is above the Claypan, Limy Subirrigated, Subirrigated, Thin Claypan, and Wet Meadow ecological sites. Due to the hydrologic impact of extensive tile drainage (e.g. lowering of the water table) in the MLRA, several soils that formed naturally as a Wet Meadow ecological site now function as Clayey ecological site.

### Associated sites

R056BY087MN	<b>Limy Subirrigated</b> This site occurs lower on the landscape. It is highly calcareous in the upper part of the subsoil; it has redoximorphic features at a depth of 18 to 30 inches.
R056BY094MN	<b>Loamy</b> This site occurs on similar landscape positions. The surface and subsoil layers form a ribbon 1 to 2 inches thick.
R056BY095MN	<b>Subirrigated</b> This site occurs somewhat lower on the landscape. It is non-calcareous to a depth >16 inches; it has redoximorphic features at a depth of 18 to 30 inches.

R056BY102MN	<b>Wet Meadow</b> This site occurs in depressions and on poorly drained flats. It has redoximorphic features within a depth of 18 inches.
-------------	--

## Similar sites

R056BY094MN	<b>Loamy</b> This site occurs on similar landscape positions. The surface and subsoil layers form a ribbon 1 to 2 inches thick
-------------	---

**Table 1. Dominant plant species**

Tree	Not specified
Shrub	Not specified
Herbaceous	(1) <i>Nassella</i> (2) <i>Andropogon gerardii</i>

## Physiographic features

This site typically occurs on glacial lake plains, small areas of ground moraine surrounded by lake plains, and delta plains. This site is typically on flats and rises; it also occurs on side slopes of drainageways and on natural levees along major streams and rivers.

**Table 2. Representative physiographic features**

Landforms	(1) Lake plain (2) Till-floored lake plain (3) Ground moraine (4) Levee (5) Drainageway (6) Delta plain
Runoff class	Low to very low
Flooding frequency	None
Ponding duration	Long (7 to 30 days)
Ponding frequency	None to frequent
Elevation	750–1,480 ft
Slope	0–5%
Ponding depth	0–6 in
Water table depth	0–18 in
Aspect	Aspect is not a significant factor

## Climatic features

About 70 percent of the rainfall comes from high-intensity, convective thunderstorms during the growing season. Winter precipitation accounts for about 15 percent of the annual precipitation.

**Table 3. Representative climatic features**

Frost-free period (characteristic range)	103-108 days
Freeze-free period (characteristic range)	133-136 days
Precipitation total (characteristic range)	22-23 in
Frost-free period (actual range)	102-110 days
Freeze-free period (actual range)	132-137 days

Precipitation total (actual range)	22-24 in
Frost-free period (average)	106 days
Freeze-free period (average)	135 days
Precipitation total (average)	23 in

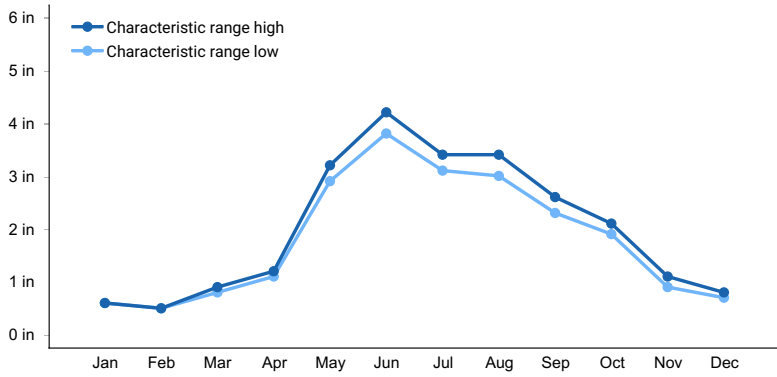

**Figure 1. Monthly precipitation range**

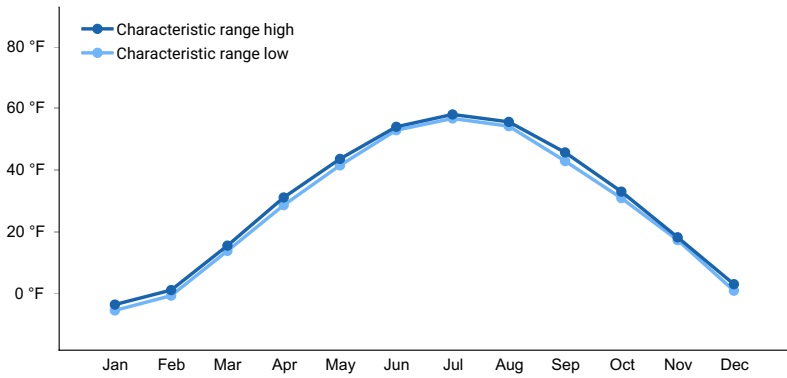

**Figure 2. Monthly minimum temperature range**

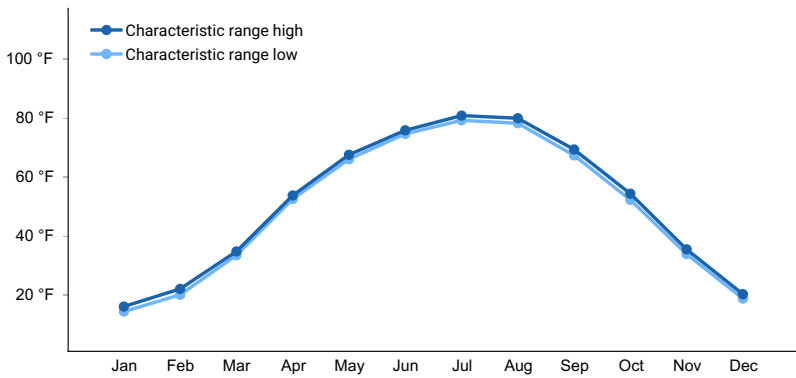

**Figure 3. Monthly maximum temperature range**

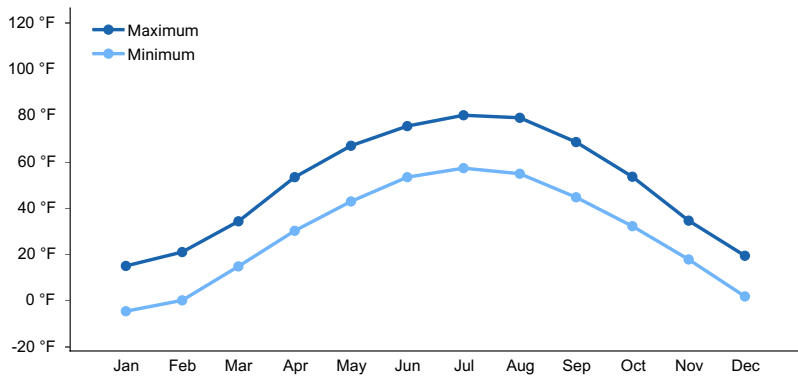

**Figure 4. Monthly average minimum and maximum temperature**

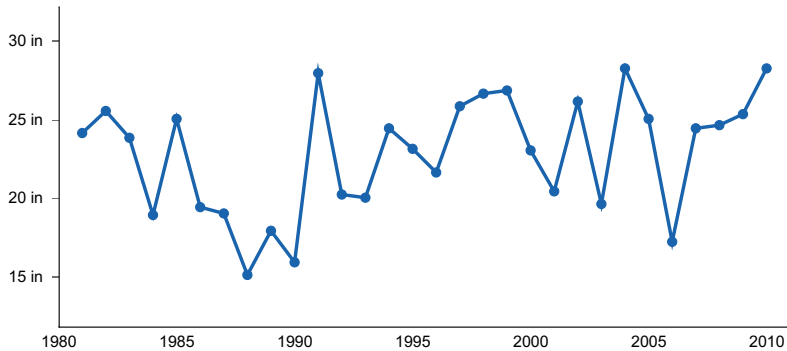

**Figure 5. Annual precipitation pattern**

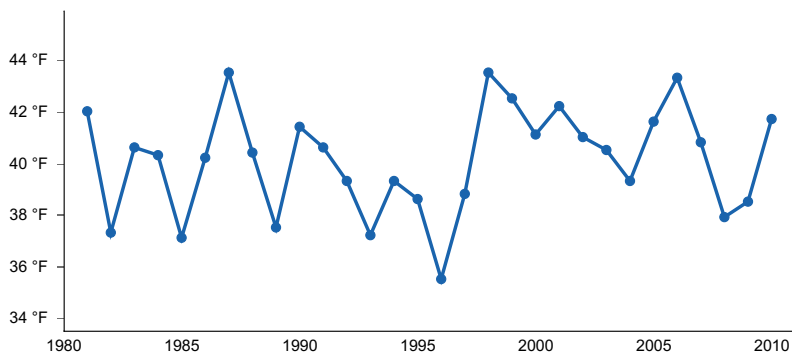

**Figure 6. Annual average temperature pattern**

### Climate stations used

- (1) GOODRIDGE 12 NNW [USW00004994], Grygla, MN
- (2) AGASSIZ REFUGE [USC00210050], Grygla, MN
- (3) RED LAKE FALLS [USC00216787], Red Lake Falls, MN
- (4) CROOKSTON NW EXP STN [USC00211891], Crookston, MN
- (5) HALLOCK [USC00213455], Hallock, MN

### Influencing water features

This site does not receive significant additional water during the growing season, either as runoff from adjacent slopes or from a seasonal high water table. Although the seasonal water table can be from 0 to 18 inches early in the growing season, Depth to the water table is typically more than 3 feet through most of the growing season. The soils have a moderately slow to very slow infiltration rate and saturated hydraulic conductivity in the clayey subsoil is moderately low. Water loss on this site occurs through transpiration and/or percolation below the root zone.

### Wetland description

Not Applicable.

## Soil features

Soils associated with the Clayey ecological site are in the Mollisol & Vertisol orders. These soils were developed under prairie vegetation. They formed in silty and clayey glaciolacustrine sediments. On lake plains the parent material is either fine-silty or clayey. On ground moraines the parent material is either fine-loamy or clayey. The parent material is clayey on delta plains, levees, and drainageways. The soils on this site are very deep. The common feature of soils in this site is a fine-textured subsoil (>35% clay) that is not dense enough to be root restrictive. Typically, the subsoil is silty clay or clay, but clay loam or silty clay loam also occur. The surface layer is 7 to more than 20 inches thick. Most commonly the surface texture is silty clay, clay, or silty clay loam; but it is loam or silt loam, in some soils. Some soils have sand textures below a depth of 40 inches.

When dry, these soils crack. When the soils are wet, surface compaction can occur with heavy traffic. This site typically should show slight to no evidence of rills, wind-scoured areas or pedestalled plants. Water flow paths should not be present, and the soil surface is stable and intact. Sub-surface soil layers are non-restrictive to water movement and root penetration. These soils are susceptible to water and wind erosion.

Major soil series correlated to the Clayey site are: Clearwater, Foxlake, Reis, and Mustinka among others.

Access Web Soil Survey ( <https://websoilsurvey.sc.egov.usda.gov/App/WebSoilSurvey.aspx> ) for specific local soils information.

**Table 4. Representative soil features**

Parent material	(1) Glaciolacustrine deposits (2) Till
Surface texture	(1) Silty clay (2) Clay (3) Silty clay loam (4) Clay loam (5) Loam
Drainage class	Poorly drained to well drained
Permeability class	Very slow to moderately slow
Depth to restrictive layer	80 in
Soil depth	80 in
Surface fragment cover <=3"	0%
Surface fragment cover >3"	0%
Available water capacity (0-60in)	4.9–7.3 in
Soil reaction (1:1 water) (0-40in)	6.6–8.4
Subsurface fragment volume <=3" (0-40in)	1–8%
Subsurface fragment volume >3" (0-40in)	0–1%

## Ecological dynamics

This ecological site description is based on nonequilibrium ecology and resilience theory and utilizes a State-and-Transition Model (STM) diagram to organize and communicate information about ecosystem change as a basis for management. The ecological dynamics characterized by the STM diagram reflect how changes in ecological drivers, feedback mechanisms, and controlling variables can maintain or induce changes in plant community composition (phases and/or states). The application of various management actions, coupled with weather variables, impact the ecological processes which influence the competitive interactions thereby maintaining or altering plant community structure.

Prior to European influence, the historical disturbance regime for MLRA 56B included frequent fires, both anthropogenic and natural in origin. Most fires, however, were anthropogenic fires set by Native Americans. Native Americans set fires in all months except perhaps January. These fires occurred in two peak periods, one from March-May with the peak in April and another from July-November with the peak occurring in October. Most of these fires were scattered and of small extent and duration. The grazing history would have involved grazing and browsing by large herbivores such as American bison, elk, and whitetail deer. Herbivory by small mammals, insects, nematodes and other invertebrates are also important factors influencing the production and composition of the communities. Grazing and fire interaction, particularly when coupled with drought events, influenced the dynamics discussed and displayed in the following state and transition diagram and descriptions.

Following European influence, this ecological site generally has had a history of grazing by domestic livestock, particularly cattle, which along with other related activities (e.g. fencing, water development, fire suppression) has changed the disturbance regime of the site. Changes will occur in the plant communities due to these and other factors.

Weather fluctuations, coupled with managerial factors, may lead to changes in the plant communities, and, under adverse impacts, may result in a slow decline in vegetative vigor and composition. However, under favorable conditions the botanical composition may resemble that prior to European influence.

Five vegetative states have been identified for the site (Reference, Native/Invaded, Invaded, Go-Back, and cropland). Within each state one or more community phases have been identified. These community phases are named based on the more dominant and visually conspicuous species, and have been determined by study of historical documents, relict areas, scientific studies, and ecological aspects of plant species and plant communities. Transitional pathways and thresholds have been determined through similar methods.

State 1: Reference State represents the natural range of variability that dominated the dynamics of this ecological site prior to European influence. Dynamics of the state were largely determined by variations in climate and weather (e.g. drought) as well as that of fire (e.g. timing, frequency), and grazing by native herbivores (e.g. frequency, intensity, selectivity). Due to those variations, the Reference State is thought to have shifted temporally and spatially between two Plant Community Phases.

Presently the primary disturbances are due to the widespread introduction of exotic species, concentrated livestock grazing, lack of fire, and perhaps long-term non-use and no fire. Because of these changes (particularly the widespread occurrence of exotic species), as well as other environmental changes, the Reference State is considered to no longer exist. Thus, the presence of exotic species on the site precludes it from being placed in the Reference State. It must then be placed in one of the other states, most commonly State 2: Native/Invaded State (T1A).

State 2: Native/Invaded State: Colonization of the site by exotic species results in a transition from State 1: Reference State to State 2: Native/Invaded State (T1A). This transition was probably inevitable; it often resulted from colonization by exotic cool-season grasses such as Kentucky bluegrass, smooth brome, and/or quackgrass which have been particularly and consistently invasive under extended periods of no use and no fire. Other exotics such as Canada thistle and leafy spurge are also known to invade the site.

Two community phases have been identified for this state and are similar to the two community phases in the Reference State but have now been invaded by exotic cool-season grasses. These exotic cool-season grasses can be expected to increase. As that increase occurs, plants more desirable to wildlife and livestock may decline. A decline in forb diversity can also be expected. Under no use or minimal use management mulch increases and may become a physical barrier to plant growth. It also changes the micro-climate near the surface and may alter infiltration, nutrient cycling, and biological activity near the soil surface. As a result, these factors coupled with shading cause desirable native plants to have increasing difficulty remaining viable and recruitment declines. To slow or limit the invasion of these exotic grasses or other exotic plants, it is imperative that managerial options (e.g. prescribed grazing, prescribed burning) be carefully constructed and evaluated with respect to that objective. If management does not include measures to control or reduce these exotic plants, the transition to State 3: Invaded State should be expected (T2A). The threshold to this transition is reached when the exotic cool-season grasses exceed 30% of the plant community and native grasses represent less than 40% of the community.

State 3: Invaded State. The threshold for this state is reached when the exotic cool-season grasses exceed 30% of

the plant community and native grasses represent less than 40% of the community. One plant community phase has been identified for this state.

The exotic cool-season grasses can be quite invasive and often form monotypic stands. As they increase, both forage quantity and quality of the annual production becomes increasingly restricted to late spring and early summer even though annual production may increase. Forb diversity often declines. Under non-use or minimal use management, mulch can increase and becomes a physical barrier to plant growth and alters nutrient cycling, infiltration, and biological activity. As such, desirable native plants become increasingly displaced.

Once the state is well established, prescribed burning and prescribed grazing techniques have been largely ineffective in suppressing or eliminating the exotic cool-season grasses, even though some short-term reductions may appear successful. However, assuming there is an adequate component of native grasses to respond to treatments, a restoration pathway to State 2: Native/Invaded State (R3A) may be accomplished with the implementation of long-term prescribed grazing in conjunction with prescribed burning.

State 4: Go-Back State often results following cropland abandonment and consists of only one plant community phase. This weedy assemblage may include noxious weeds that need control. Over time, the exotic cool-season grasses Kentucky bluegrass, smooth brome, and/or quackgrass will likely predominate.

Initially, due to extensive bare ground and a preponderance of shallow rooted annual plants, infiltration is low and the potential for soil erosion is high. Plant species richness may be high, but overall diversity (i.e. equitability) is typically low with the site dominated by a relatively small assemblage of species. Due to the lack of native perennials and other factors, restoring the site with the associated ecological processes is difficult. However, a successful range planting may result in something approaching State 2: Native/Invaded State (R4A). Following planting, prescribed grazing, prescribed burning, haying, and the use of herbicides will generally be necessary to achieve the desired result and control weeds, some of which may be noxious weeds. A failed range planting and/or secondary succession will lead to State 3: Invaded State (R4B).

State 5: Cropland State results from planting and production of annual crops. This plant community is most commonly associated with cropped fields. Soil conditions can be quite variable on the site, in part due to variations in the management/cropping history (e.g. development of tillage induced compaction, erosion, fertility, herbicide/pesticide carryover). Thus, soil conditions should be assessed when considering restoration techniques..

The following state and transition model diagram illustrate the common states, community phases, community pathways, transition and restoration pathways that can occur on the site. These are the most common plant community phases and states based on current knowledge and experience; changes may be made as more data are collected. Pathway narratives describing the site's ecological dynamics reference various management practices (e.g. prescribed grazing, prescribed burning, brush management, herbaceous weed treatment) which, if properly designed and implemented, will positively influence plant community competitive interactions. The design of these management practices will be site specific and should be developed by knowledgeable individuals and based upon management goals, a resource inventory, and supported by an ongoing monitoring protocol.

When the management goal is to maintain an existing plant community phase or restore to another phase within the same state, modification of existing management to ensure native species have the competitive advantage may be required. To restore a previous state, the application of two or more management practices in an ongoing manner will be required. Whether using prescribed grazing, prescribed burning, or a combination of both with or without additional practices (e.g. brush management), the timing and method of application needs to favor the native species over the exotic species. Adjustments to account for variations in annual growing conditions and implementing an ongoing monitoring protocol to track changes and adjust management inputs to ensure desired outcome will be necessary.

The plant community phase composition table(s) has been developed from the best available knowledge including research, historical records, clipping studies, and inventory records. As more data are collected, plant community species composition and production information may be revised.

## **State and transition model**

## Ecosystem states

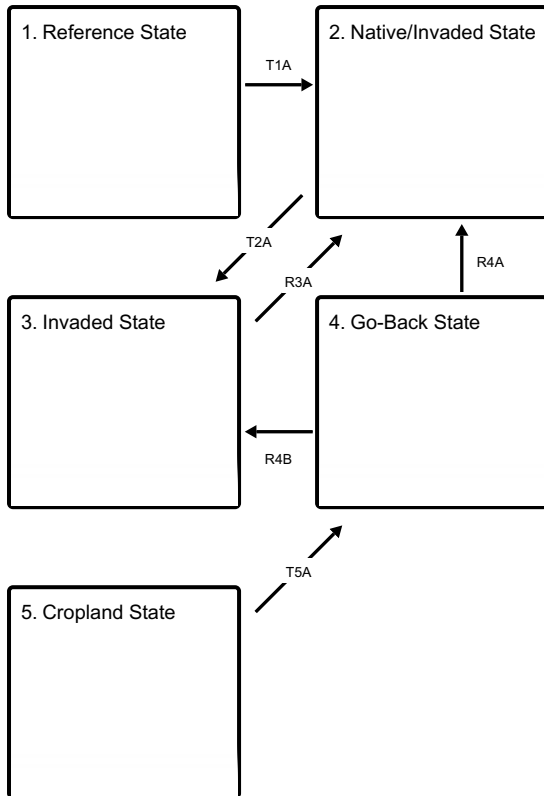

**T1A** - Introduction of exotic cool-season grasses

**T2A** - Extended periods of non-use or very light grazing, no fire

**R3A** - Long term prescribed grazing with prescribed burning

**R4A** - Successful range planting with prescribed grazing and prescribed burning

**R4B** - Failed range planting and/or secondary succession

**T5A** - Cessation of annual cropping

## State 1 submodel, plant communities

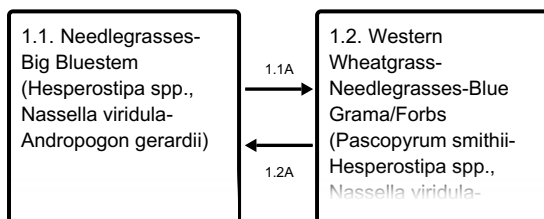

**1.1A** - Heavy season-long grazing with or without drought

**1.2A** - Return to average growing conditions and reduced grazing pressure

## State 2 submodel, plant communities

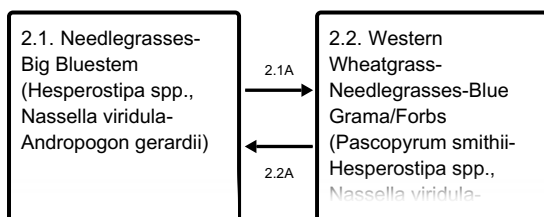

**2.1A** - Heavy season-long grazing with or without drought

**2.2A** - Long term prescribed grazing with prescribed burning



### State 3 submodel, plant communities



### State 4 submodel, plant communities

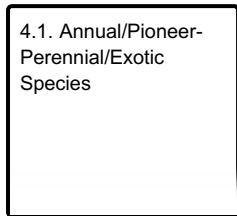

## State 1 Reference State

This state represents the natural range of variability that dominated the dynamics of this ecological site prior to European influence. The state was composed predominantly of cool-season grasses. The primary disturbance mechanisms for this site in the reference condition included occasional fire and grazing by large herding ungulates. Timing of fires and grazing, coupled with weather events, dictated the dynamics that occurred within the natural range of variability. These factors likely caused the community to shift both spatially and temporally between two community phases.

**Characteristics and indicators.** (i.e. Characteristics and indicators that can be used to distinguish this state from others). Because of changes in disturbances and other environmental factors (particularly the widespread occurrence of exotic species), the Reference State is considered to no longer exist

**Resilience management.** (i.e. management strategies that will sustain a state and prevent a transition). If intact, the reference state should probably be managed with current disturbance regimes which has permitted the site to remain in reference condition as well as maintaining the quality and integrity of associated ecological sites. Maintenance of the reference state is contingent upon a monitoring protocol to guide management.

### Dominant plant species

- leadplant (*Amorpha canescens*), shrub
- prairie sagewort (*Artemisia frigida*), shrub
- prairie rose (*Rosa arkansana*), shrub
- western snowberry (*Symphoricarpos occidentalis*), shrub
- needle and thread (*Hesperostipa comata*), grass
- porcupinegrass (*Hesperostipa spartea*), grass
- green needlegrass (*Nassella viridula*), grass
- big bluestem (*Andropogon gerardii*), grass
- western wheatgrass (*Pascopyrum smithii*), grass
- dotted blazing star (*Liatris punctata*), other herbaceous
- upright prairie coneflower (*Ratibida columnifera*), other herbaceous
- purple prairie clover (*Dalea purpurea*), other herbaceous
- white sagebrush (*Artemisia ludoviciana*), other herbaceous

### Community 1.1

#### Needlegrasses-Big Bluestem (*Hesperostipa* spp., *Nassella viridula*-*Andropogon gerardii*)

This community phase was historically the most dominant both temporally and spatially. It may be described as having been predominantly composed of cool-season grasses. The main grasses included green needlegrass, western wheatgrass, porcupinegrass, needle and thread, slender wheatgrass, and bearded wheatgrass. Other associated graminoids included the warm-season grasses such as big bluestem, little bluestem, and blue grama. A

diverse forb component was also present and often included dotted blazing star, upright prairie coneflower, purple prairie clover, and silverleaf Indian breadroot. Prairie sagewort, leadplant, prairie rose, and western snowberry were among the more common shrubs. Annual production ranged roughly between 2100 to 3700 pounds per acre with graminoids, forbs, and shrubs contributing about 85%, 10%, and 5% of the production respectively. Community Phase 1.1 is considered the Reference Plant Community upon which most interpretations are based and is described in the “Plant Community Composition and Group Annual Production” portion of this ecological site description.

**Table 5. Annual production by plant type**

Plant Type	Low (Lb/Acre)	Representative Value (Lb/Acre)	High (Lb/Acre)
Grass/Grasslike	1785	2465	3145
Forb	210	290	370
Shrub/Vine	105	145	185
<b>Total</b>	<b>2100</b>	<b>2900</b>	<b>3700</b>

## Community 1.2

### Western Wheatgrass-Needlegrasses-Blue Grama/Forbs (*Pascopyrum smithii*-*Hesperostipa* spp., *Nassella viridula*-*Bouteloua gracilis*/Forbs)

This community phase resulted from heavy season-long grazing with or without drought. Blue grama, western wheatgrass, and forbs had markedly increased in comparison to Community Phase 1.1 while big bluestem had declined. Forbs commonly showing an increase would have included silverleaf Indian breadroot, white heath aster, common yarrow, and white sagebrush. Annual production was likely somewhat reduced compared to that of Community Phase 1.1.

### Pathway 1.1A

#### Community 1.1 to 1.2

Community Phase Pathway 1.1 to 1.2 occurred with heavy season-long grazing with or without drought. This resulted in an increase in western wheatgrass, blue grama, and forbs with a corresponding decrease in big bluestem.

### Pathway 1.2A

#### Community 1.2 to 1.1

This Community Phase Pathway 1.2 to 1.1 occurred upon return to average growing conditions and reduced grazing pressure leading to an increase in big bluestem and corresponding decrease in blue grama, western wheatgrass, and forbs.

## State 2

### Native/Invaded State

This State is similar to the State 1: Reference State but has now been colonized by the exotic cool-season grasses, often Kentucky bluegrass, smooth brome, and/or quackgrass. Although the state is still dominated by native grasses, an increase in the exotic cool-season grasses can be expected. These exotic cool-season grasses can be quite invasive on the site and are particularly well adapted to heavy grazing. They also often form monotypic stands. As these exotic cool-season grasses increase, both forage quantity and quality become increasingly restricted to late spring and early summer due to the monotypic nature of the stand even though annual production may increase. Native forbs generally decrease in production, abundance, diversity, and richness compared to that of State 1: Reference State. These exotic cool-season grasses have been particularly and consistently invasive under extended periods of no use and no fire. If management does not include measures to control or reduce these exotic cool-season grasses, the transition to State 3: Invaded State should be expected. Annual production of this state can be quite variable, in large part due to the amount of exotic cool-season grasses. However, annual production may be in the range of 1300-2500 pounds per acre.

**Characteristics and indicators.** The presence of trace amounts of exotic cool-season grasses indicates a transition from State 1 to State 2. The presence of exotic biennial or perennial leguminous forbs (i.e. sweet clover, black medic) may not, on their own, indicate a transition from State 1 to State 2 but may facilitate that transition.

**Resilience management.** To slow or limit the invasion of these exotic grasses, it is imperative that managerial options (e.g. prescribed grazing, prescribed burning) be carefully constructed and evaluated with respect to that objective. Grazing management should be applied that enhances the competitive advantage of native grass and forb species. This may include: (1) grazing when exotic cool-season grasses are actively growing and native cool-season grasses are dormant; (2) applying proper deferment periods allowing native grasses to recover and maintain or improve vigor; (3) adjusting overall grazing intensity to reduce excessive plant litter (above that needed for rangeland health indicator #14 – see Rangeland Health Reference Worksheet); (4) incorporating early heavy spring utilization which focuses grazing pressure on exotic cool-season grasses and reduces plant litter provided that livestock are moved when grazing selection shifts from exotic cool-season grasses to native grasses. Prescribed burning should be applied in a manner that maintains or enhances the competitive advantage of native grass and forb species. Prescribed burns should be applied as needed to adequately reduce/remove excessive plant litter and maintain the competitive advantage for native species. Timing of prescribed burns (spring vs. summer vs. fall) should be adjusted to account for differences in annual growing conditions and applied during windows of opportunity to best shift the competitive advantage to the native species.

### **Dominant plant species**

- prairie rose (*Rosa arkansana*), shrub
- western snowberry (*Symphoricarpos occidentalis*), shrub
- leadplant (*Amorpha canescens*), shrub
- needle and thread (*Hesperostipa comata*), grass
- porcupinegrass (*Hesperostipa spartea*), grass
- green needlegrass (*Nassella viridula*), grass
- big bluestem (*Andropogon gerardii*), grass
- western wheatgrass (*Pascopyrum smithii*), grass
- goldenrod (*Solidago*), other herbaceous
- silverleaf Indian breadroot (*Pediomelum argophyllum*), other herbaceous
- white sagebrush (*Artemisia ludoviciana*), other herbaceous
- purple coneflower (*Echinacea*), other herbaceous
- upright prairie coneflower (*Ratibida columnifera*), other herbaceous

### **Community 2.1**

#### **Needlegrasses-Big Bluestem (*Hesperostipa* spp., *Nassella viridula*-*Andropogon gerardii*)**

This Community Phase is similar to Community Phase 1.1 but has been colonized by exotic cool-season grasses, often Kentucky bluegrass, smooth brome, and/or quackgrass. However, these exotics are present in smaller amounts with the community still dominated by native grasses.

### **Community 2.2**

#### **Western Wheatgrass-Needlegrasses-Blue Grama/Forbs (*Pascopyrum smithii*-*Hesperostipa* spp., *Nassella viridula*-*Bouteloua gracilis*/Forbs)**

This Community Phase is similar to Community Phase 1.2 but has now been colonized by exotic cool-season grasses, often Kentucky bluegrass, smooth brome, and/or quackgrass. These exotics, however, are present in smaller amounts with the community still dominated by native grasses. This community phase is often dispersed throughout a pasture in an overgrazed/undergrazed pattern, typically referred to as patch grazing. Some overgrazed areas will exhibit the impacts of heavy use, while the ungrazed areas will have a build-up of litter and increased plant decadence. This is a typical pattern found in properly stocked pastures grazed season long. As a result, Kentucky bluegrass tends to increase more in the undergrazed areas while the more grazing tolerant short-statured species, such as blue grama and sedges, increase in the heavily grazed areas. This Community Phase is approaching the threshold leading to a transition to State 3: Invaded State. As a result, it is an “at risk” community. If management does not include measures to control or reduce these exotic cool-season grasses, the transition to State 3: Invaded State should be expected.

## **Pathway 2.1A**

### **Community 2.1 to 2.2**

This Community Phase Pathway 2.1 to 2.2 results from heavy season-long grazing, with or without drought, leading to an increase in blue grama, western wheatgrass, and forbs with a corresponding decrease in big bluestem.

## **Pathway 2.2A**

### **Community 2.2 to 2.1**

This Community Phase Pathway 2.2 to 2.1 occurs with long term prescribed grazing and prescribed burning resulting in a decrease in blue grama, western wheatgrass, and forbs with a corresponding increase in big bluestem.

## **State 3**

### **Invaded State**

This state is the result of invasion and dominance by the exotic cool-season grasses, commonly Kentucky bluegrass, smooth brome, and/or quackgrass. These exotic cool-season grasses can be quite invasive on the site and are particularly well adapted to heavy grazing. They also often form monotypic stands. As these exotic cool-season grasses increase, both forage quantity and quality become increasingly restricted to late spring and early summer due to the monotypic nature of the stand even though annual production may increase. Native forbs generally decrease in production, abundance, diversity, and richness compared to that of State 1: Reference State. Common forbs often include silverleaf Indian breadroot, white heath aster, goldenrods, common yarrow, and white sagebrush. Shrubs such as western snowberry and prairie rose, however, may show marked increases. Once the state is well established, prescribed burning and grazing techniques have been largely ineffective in suppressing or eliminating these three species even though some short-term reductions may appear successful. Annual production of this state may vary widely, in part due to variations in the extent of invasion by exotic cool-season grasses. However, annual production may be in the range of 900-3000 pounds per acre with the exotic cool-season grasses accounting for the bulk of the annual production.

**Characteristics and indicators.** This site is characterized by exotic cool-season grasses constituting greater than 30 percent of the annual production and native grasses constituting less than 40 percent of the annual production.

**Resilience management.** Light or moderately stocked continuous, season-long grazing or a prescribed grazing system which incorporates adequate deferment periods between grazing events and proper stocking rate levels will maintain this State. Application of herbaceous weed treatment, occasional prescribed burning, and/or brush management may be needed to manage noxious weeds and increasing shrub (e.g. western snowberry) populations.

### **Dominant plant species**

- western snowberry (*Symphoricarpos occidentalis*), shrub
- prairie rose (*Rosa arkansana*), shrub
- Kentucky bluegrass (*Poa pratensis*), grass
- smooth brome (*Bromus inermis*), grass
- quackgrass (*Elymus repens*), grass
- silverleaf Indian breadroot (*Pediomelum argophyllum*), other herbaceous
- goldenrod (*Solidago*), other herbaceous
- white heath aster (*Symphotrichum ericoides*), other herbaceous
- white sagebrush (*Artemisia ludoviciana*), other herbaceous

## **Community 3.1**

### **Exotic Grasses/Forbs**

This community phase is dominated by exotic cool-season sodgrasses such as Kentucky bluegrass, smooth brome, and/or quackgrass, often with a much-reduced forb and shrub component. Excessive accumulation of mulch may also be present, particularly when dominated by Kentucky bluegrass. Common forbs often include silverleaf Indian breadroot, white heath aster, goldenrods, common yarrow, and white sagebrush. Shrubs may include western

snowberry and prairie rose.

## **State 4**

### **Go-Back State**

This state is highly variable depending on the level and duration of disturbance related to the T5A transitional pathway. In this MLRA, the most probable origin of this state is plant succession following cropland abandonment. This plant community will initially include a variety of annual forbs and grasses, some of which may be noxious weeds needing control. Over time, however, the exotic cool-season grasses Kentucky bluegrass, smooth brome, and/or quackgrass will likely predominate.

**Characteristics and indicators.** Tillage has destroyed the native plant community, altered soil structure and biology, reduced soil organic matter, and resulted in the formation of a tillage induced compacted layer which is restrictive to root growth. Noxious weeds, if present, will need to be managed.

#### **Dominant plant species**

- cheatgrass (*Bromus tectorum*), grass
- Kentucky bluegrass (*Poa pratensis*), grass
- leafy spurge (*Euphorbia esula*), other herbaceous
- Canada thistle (*Cirsium arvense*), other herbaceous

## **Community 4.1**

### **Annual/Pioneer-Perennial/Exotic Species**

This state is highly variable depending on the level and duration of disturbance related to the T5A transitional pathway. In this MLRA, the most probable origin of this state is plant succession following cropland abandonment. This plant community will initially include a variety of annual forbs and grasses, some of which may be noxious weeds needing control. Over time, however, the exotic cool-season grasses Kentucky bluegrass, smooth brome, and/or quackgrass will likely predominate.

## **State 5**

### **Cropland State**

This plant community is most commonly associated with cropped fields. Soil conditions can be quite variable on the site, in part due to variations in the management/cropping history (e.g. development of tillage induced compaction, erosion, fertility, herbicide/pesticide carryover). Thus, soil conditions should be assessed when considering restoration techniques.

#### **Dominant plant species**

- corn (*Zea*), other herbaceous
- soybean (*Glycine*), other herbaceous

## **Transition T1A**

### **State 1 to 2**

This is the transition from the State 1: Reference State to the State 2: Native/Invaded State due to the introduction and establishment of exotic cool-season grasses, typically Kentucky bluegrass, smooth brome, and/or quackgrass. This transition was probably inevitable and corresponded to a decline in native warm-season and cool-season grasses. This transition was exacerbated by chronic season-long or heavy late season grazing. Complete rest from grazing and suppression of fire would have also hastened this transition. The threshold between states was crossed when Kentucky bluegrass, smooth brome, quackgrass, or other exotic species became established on the site.

**Constraints to recovery.** (i.e. variables or processes that preclude recovery of the former state). Current knowledge and technology will not facilitate a successful restoration to Reference State.

## **Transition T2A**

## State 2 to 3

This transition from the State 2: Native/Invaded State to State 3: Invaded State generally occurs with heavy season-long grazing or extended periods of non-use. Exotic cool-season grasses such as quackgrass, Kentucky bluegrass, and/or perhaps smooth brome become the dominant graminoids. Studies indicate that a threshold may exist in this transition when Kentucky bluegrass exceeds 30% of the plant community and native grasses represent less than 40% of the plant community composition. Similar thresholds may exist for smooth brome and quackgrass.

**Constraints to recovery.** Variations in growing conditions (e.g. cool, wet spring) will influence effects of various management activities on exotic cool-season grass populations.

## Restoration pathway R3A

### State 3 to 2

This restoration pathway from State 3: Invaded State to State 2: Native/Invaded State may be accomplished with the implementation of long-term prescribed grazing and prescribed burning, assuming there is an adequate component of native grasses to respond to the treatments. Both prescribed grazing and prescribed burning are likely necessary to successfully initiate this restoration pathway, the success of which depends upon the presence of a remnant population of native grasses in Community Phase 3.1. That remnant population, however, may not be readily apparent without close inspection. The application of several prescribed burns may be needed at relatively short intervals in the early phases of this restoration process, in part because many of the shrubs (e.g. western snowberry) sprout profusely following one burn. Early season prescribed burns have been successful; however, fall burning may also be an effective technique.

**Context dependence.** Grazing management should be applied in a manner that enhances/maximizes the competitive advantage of native grass and forb species over the exotic species. This may include the use of prescribed grazing to reduce excessive plant litter accumulations above that needed for rangeland health indicator #14 (see Rangeland Health Reference Worksheet). Increasing livestock densities may facilitate the reduction in plant litter provided length and timing of grazing periods are adjusted to favor native species. Grazing prescriptions designed to address exotic grass invasion and favor native species may involve earlier, short, intense grazing periods with proper deferment to improve native species health and vigor. Fall (e.g. September, October) prescribed burning followed by an intensive, early spring graze period with adequate deferment for native grass recovery may shift the competitive advantage to the native species, facilitating the restoration to State 2: Native/Invaded. Prescribed burning should be applied in a manner that enhances the competitive advantage of native grass and forb species over the exotic species. Prescribed burns should be applied at a frequency which mimics the natural disturbance regime, or more frequently as is ecologically (e.g. available fuel load) and economically feasible. Burn prescriptions may need adjustment to: (1) account for change in fine fuel orientation (e.g. "flopped" Kentucky bluegrass); (2) fire intensity and duration by adjusting ignition pattern (e.g. backing fires vs head fires); (3) account for plant phenological stages to maximize stress on exotic species while favoring native species (both cool- and warm-season grasses). The longer this community phase exists, the more resilient it becomes. Natural or management disturbances that reduce the cover of Kentucky bluegrass or smooth brome are typically short-lived.

## Restoration pathway R4A

### State 4 to 2

This Restoration Pathway from State 4: Go-Back State to the State 2: Native/Invaded State can be accomplished with a successful range planting. Following planting, prescribed grazing, prescribed burning, haying, or use of herbicides will generally be necessary to achieve the desired result and control any noxious weeds. It may be possible using selected plant materials and agronomic practices to approach something very near the functioning of State 2: Native/Invaded State. Application of chemical herbicides and the use of mechanical planting methods using adapted varieties of the dominant native grasses are possible and can be successful. After establishment of the native plant species, prescribed grazing should include adequate recovery periods following each grazing event and stocking levels which match the available resources; management objectives must include the maintenance of those species, the associated reference state functions, and continued treatment of exotic grasses

**Context dependence.** A successful range planting will include proper seedbed preparation, weed control (both prior to and after the planting), selection of adapted native species representing functional/structural groups inherent to the State 1, and proper seeding technique. Management (e.g. prescribed grazing, prescribed burning) during and

after establishment must be applied in a manner that maintains the competitive advantage for the seeded native species. Adding non-native species can impact the above and below ground biota. Elevated soil nitrogen levels have been shown to benefit smooth brome and Kentucky bluegrass more than some native grasses. As a result, fertilization, exotic legumes in the seeding mix, and other techniques that increase soil nitrogen may promote smooth brome and Kentucky bluegrass invasion. The method or methods of herbaceous weed treatment will be site specific to each situation but, generally, the goal would be to apply the pesticide, mechanical control, or biological control - either singularly or in combination - in a manner that shifts the competitive advantage from the targeted species to the native grasses and forbs. The control method(s) should be as specific to the targeted species as possible to minimize impacts to non-target species.

## Restoration pathway R4B State 4 to 3

A failed range planting and/or secondary succession will lead to State 2: Native/Invaded State.

**Context dependence.** Failed range plantings can result from many causes, both singularly and in combination, including: drought, poor seedbed preparation, improper seeding methods, seeded species not adapted to the site, insufficient weed control, herbicide carryover, poor seed quality (purity & germination), improper management

## Transition T5A State 5 to 4

This is the Transition from any plant community to State 4: Go-Back State. It is most commonly associated with the cessation of cropping without the benefit of range planting, resulting in a “go-back” situation. Soil conditions can be quite variable on the site, in part due to variations in the management/cropping history (e.g. development of tillage induced compaction, erosion, fertility, herbicide/pesticide carryover). Thus, soil conditions should be assessed when considering restoration techniques.

## Additional community tables

Table 6. Community 1.1 plant community composition

Group	Common Name	Symbol	Scientific Name	Annual Production (Lb/Acre)	Foliar Cover (%)
<b>Grass/Grasslike</b>					
1	<b>Needlegrass</b>			435–725	
	green needlegrass	NAVI4	<i>Nassella viridula</i>	290–580	–
	porcupinegrass	HESP11	<i>Hesperostipa spartea</i>	145–290	–
	needle and thread	HECOC8	<i>Hesperostipa comata ssp. comata</i>	145–290	–
2	<b>Wheatgrass</b>			580–870	
	western wheatgrass	PASM	<i>Pascopyrum smithii</i>	580–1015	–
	slender wheatgrass	ELTR7	<i>Elymus trachycaulus</i>	58–290	–
	bearded wheatgrass	ELCA11	<i>Elymus caninus</i>	58–290	–
3	<b>Tall/Mid Warm-Season Grasses</b>			145–290	
	big bluestem	ANGE	<i>Andropogon gerardii</i>	29–290	–
	sideoats grama	BOCU	<i>Bouteloua curtipendula</i>	0–145	–
	prairie dropseed	SPHE	<i>Sporobolus heterolepis</i>	0–145	–
	little bluestem	SCSC	<i>Schizachyrium scoparium</i>	0–145	–
4	<b>Short Warm-Season Grasses</b>			0–145	
	blue grama	BOGR2	<i>Bouteloua gracilis</i>	0–145	–
5	<b>Other Native Grasses</b>			0–290	
	prairie Junegrass	KOMA	<i>Koeleria macrantha</i>	0–290	–
	Scribner's rosette grass	DIOLS	<i>Dichanthelium oligosanthes var.</i>	0–290	–

			<i>scribnerianum</i>		
	Graminoid (grass or grass-like)	2GRAM	<i>Graminoid (grass or grass-like)</i>	0–290	–
6	<b>Other Grass-Likes</b>			29–145	
	needleleaf sedge	CADU6	<i>Carex duriuscula</i>	29–145	–
	Pennsylvania sedge	CAPE6	<i>Carex pensylvanica</i>	29–145	–
	Grass-like (not a true grass)	2GL	<i>Grass-like (not a true grass)</i>	0–145	–
<b>Forb</b>					
7	<b>Forbs</b>			145–290	
	Forb (herbaceous, not grass nor grass-like)	2FORB	<i>Forb (herbaceous, not grass nor grass-like)</i>	29–145	–
	white sagebrush	ARLU	<i>Artemisia ludoviciana</i>	29–87	–
	false boneset	BREU	<i>Brickellia eupatorioides</i>	29–87	–
	scarlet globemallow	SPCO	<i>Sphaeralcea coccinea</i>	29–87	–
	Cuman ragweed	AMPS	<i>Ambrosia psilostachya</i>	29–58	–
	wavyleaf thistle	CIUN	<i>Cirsium undulatum</i>	29–58	–
	purple prairie clover	DAPU5	<i>Dalea purpurea</i>	29–58	–
	western wallflower	ERAS2	<i>Erysimum asperum</i>	29–58	–
	stiff sunflower	HEPA19	<i>Helianthus pauciflorus</i>	29–58	–
	dotted blazing star	LIPU	<i>Liatriis punctata</i>	29–58	–
	scarlet beeblossom	OESU3	<i>Oenothera suffrutescens</i>	29–58	–
	stiff goldenrod	OLRI	<i>Oligoneuron rigidum</i>	29–58	–
	white heath aster	SYER	<i>Symphotrichum ericoides</i>	29–58	–
	American vetch	VIAM	<i>Vicia americana</i>	29–58	–
<b>Shrub/Vine</b>					
8	<b>Shrubs</b>			29–145	
	western snowberry	SYOC	<i>Symphoricarpos occidentalis</i>	29–145	–
	Shrub (>.5m)	2SHRUB	<i>Shrub (&gt;.5m)</i>	0–145	–
	prairie sagewort	ARFR4	<i>Artemisia frigida</i>	0–87	–
	prairie rose	ROAR3	<i>Rosa arkansana</i>	29–58	–
	leadplant	AMCA6	<i>Amorpha canescens</i>	0–29	–

## Inventory data references

This is a provisional ecological site, and as such no field plots were inventoried for this project. MLRA 56 was split into 2 MLRAs 56A and 56B with Agricultural Handbook 296 (2022). All information was taken from original MLRA 56 ecological site descriptions in which MLRA 56B was part of. Future field verification is needed to refine the plant communities and ecological dynamics described in this ecological site description.

## Other references

Bluemle, J.P. 2016. North Dakota's Geologic Legacy. North Dakota State University Press. 382 pages.

Briske, D.D. (editor). 2017. Rangeland Systems – Processes, Management, and Challenges. Springer Series on Environmental Management. 661 pages.

DeKeyser, E.S., G. Clambey, K. Krabbenhoft, and J. Ostendorf. 2009. Are changes in species composition on central North Dakota rangelands due to non-use management? Rangelands 31:16-19



- Dix, R.L. and F.E. Smeins. 1967. The prairie, meadow, and marsh vegetation of Nelson County, North Dakota. *Canadian Journal of Botany* 45:21-57.
- Dornbusch, M.J., R.F. Limb, and C.K. Gasch. 2018. Facilitation of an exotic grass through nitrogen enrichment by an exotic legume. *Rangeland Ecology & Management* 71:691-694.
- Dyke, S.R., S.K. Johnson, and P.T. Isakson. 2015. North Dakota State Wildlife Action Plan. North Dakota Game and Fish Department, Bismarck, ND. 468 pages.
- Ereth, C., J. Hendrickson, D. Kirby, E. DeKeyser, K. Sedevic, and M. West. 2017. Controlling Kentucky bluegrass with herbicide and burning is influenced by invasion level. *Invasive Plant Science and Management* 10: 80-89.
- Hendrickson, J.R., S.L. Kronberg, and E.J. Scholljegerdes. 2020. Can targeted grazing reduce abundance of invasive perennial grass (Kentucky Bluegrass) on native mixed-grass prairie? *Rangeland Ecology and Management*, 73:547-551.
- Higgins, K.F. 1984. Lightning fires in grasslands in North Dakota and in pine-savanna lands in nearby South Dakota and Montana. *J. Range Manage.* 37:100-103.
- Higgins, K.F. 1986. Interpretation and compendium of historical fire accounts in the northern great plains. United States Department of Interior, Fish and Wildlife Service. Resource Publication 161. 39 pages.
- High Plains Regional Climate Center, University of Nebraska, 830728 Chase Hall, Lincoln, NE 68583-0728. (<http://hprcc.unl.edu>)
- Johnson, Sandra. 2015. Reptiles and Amphibians of North Dakota. North Dakota Game and Fish Department. 64 pages.
- Jordan, N. R., D.L. Larson, and S.C. Huerd. 2008. Soil modification by invasive plants: effects on native and invasive species of mixed-grass prairies. *Biological Invasions* 10:177-190.
- Minnesota Department of Natural Resources. 2005. Field guide to the native plant communities of Minnesota. Minnesota DNR.
- North Dakota Division of Tourism, Accessed on February 25, 2019. Available at <https://www.ndtourism.com/sports-recreation>
- North Dakota Parks and Recreation Department, Accessed on February 25, 2019. Available at <https://www.parkrec.nd.gov/>
- Reeves, J.L., J.D. Derner, M.A. Sanderson, J.R. Hendrickson, S.L. Kronberg, M.K. Petersen, and L.T. Vermeire. 2014. Seasonal weather influences on yearling beef steer production in C3-dominated Northern Great Plains rangeland. *Agriculture, Ecosystems and Environment* 183:110-117.
- Royer, R. A., 2003. Butterflies of North Dakota: An Atlas and Guide. Minot State University, Minot, ND.
- Seabloom, R. 2011. Mammals of North Dakota. North Dakota Institute for Regional Studies, Fargo, ND. 461 pages.
- Severson, K. E. and C. Hull Sieg. 2006. The Nature of Eastern North Dakota: Pre-1880 Historical Ecology. North Dakota Institute for Regional Studies.
- Spaeth, K.E., Hayek, M.A., Toledo, D., and Hendrickson, J. 2019. Cool Season Grass Impacts on Native Mixedgrass Prairie Species in the Northern Great Plains. America's Grassland Conference: Working Across Boundaries. The Fifth Biennial Conference on the Conservation of America's Grasslands. Bismarck, ND. 20-22 August.
- USDA, NRCS. National Range and Pasture Handbook, September 1997
- USDA, NRCS. National Soil Information System, Information Technology Center, 2150 Centre Avenue, Building A,

Fort Collins, CO 80526. [https://www.nrcs.usda.gov/wps/portal/nrcs/detail/soils/survey/tools/?cid=nrcs142p2\\_053552](https://www.nrcs.usda.gov/wps/portal/nrcs/detail/soils/survey/tools/?cid=nrcs142p2_053552)

USDA, NRCS. National Water and Climate Center, 101 SW Main, Suite 1600, Portland, OR 97204-3224. <https://www.nrcs.usda.gov/wps/portal/wcc/home/>

USDA, NRCS. 2001. The PLANTS Database, Version 3.1 (<http://plants.usda.gov>). National Plant Data Center, Baton Rouge, LA 70874-4490 USA.

USDA, NRCS, Various Published Soil Surveys.

Vinton, M.A. and E.M. Goergen. 2006. Plant-soil feedbacks contribute to the persistence of *Bromus intermis* in tallgrass prairie. *Ecosystems* 9: 967-976.

## **Contributors**

Mark Hayek  
Chuck Lura  
Jeff Printz  
Alan Gulsvig  
Steve Sieler  
David Dewald  
Ezra Hoffman, Ecological Site Specialist, NRCS

## **Approval**

Suzanne Mayne-Kinney, 9/04/2024

## **Acknowledgments**

Non-discrimination Statement: In accordance with Federal civil rights law and U.S. Department of Agriculture (USDA) civil rights regulations and policies, the USDA, its Agencies, offices, and employees, and institutions participating in or administering USDA programs are prohibited from discriminating based on race, color, national origin, religion, sex, gender identity (including gender expression), sexual orientation, disability, age, marital status, family/parental status, income derived from a public assistance program, political beliefs, or reprisal or retaliation for prior civil rights activity, in any program or activity conducted or funded by USDA (not all bases apply to all programs). Remedies and complaint filing deadlines vary by program or incident. Persons with disabilities who require alternative means of communication for program information (e.g., Braille, large print, audiotope, American Sign Language, etc.) should contact the responsible Agency or USDA's TARGET Center at (202) 720-2600 (voice and TTY) or contact USDA through the Federal Relay Service at (800) 877-8339. Additionally, program information may be made available in languages other than English. To file a program discrimination complaint, complete the USDA Program Discrimination Complaint Form, AD-3027, found online at [How to File a Program Discrimination Complaint](#) and at any USDA office or write a letter addressed to USDA and provide in the letter all of the information requested in the form. To request a copy of the complaint form, call (866) 632-9992. Submit your completed form or letter to USDA by:(1) mail: U.S. Department of Agriculture Office of the Assistant Secretary for Civil Rights 1400 Independence Avenue, SW Washington, D.C. 20250-9410;(2) fax: (202) 690-7442; or(3) email: [program.intake@usda.gov](mailto:program.intake@usda.gov) USDA is an equal opportunity provider, employer, and lender.

## **Rangeland health reference sheet**

Interpreting Indicators of Rangeland Health is a qualitative assessment protocol used to determine ecosystem condition based on benchmark characteristics described in the Reference Sheet. A suite of 17 (or more) indicators are typically considered in an assessment. The ecological site(s) representative of an assessment location must be known prior to applying the protocol and must be verified based on soils and climate. Current plant community cannot be used to identify the ecological site.

Author(s)/participant(s)	
Contact for lead author	
Date	09/27/2024
Approved by	Suzanne Mayne-Kinney
Approval date	
Composition (Indicators 10 and 12) based on	Annual Production

## Indicators

1. **Number and extent of rills:**

---

2. **Presence of water flow patterns:**

---

3. **Number and height of erosional pedestals or terracettes:**

---

4. **Bare ground from Ecological Site Description or other studies (rock, litter, lichen, moss, plant canopy are not bare ground):**

---

5. **Number of gullies and erosion associated with gullies:**

---

6. **Extent of wind scoured, blowouts and/or depositional areas:**

---

7. **Amount of litter movement (describe size and distance expected to travel):**

---

8. **Soil surface (top few mm) resistance to erosion (stability values are averages - most sites will show a range of values):**

---

9. **Soil surface structure and SOM content (include type of structure and A-horizon color and thickness):**

---

10. **Effect of community phase composition (relative proportion of different functional groups) and spatial distribution on infiltration and runoff:**

---

11. **Presence and thickness of compaction layer (usually none; describe soil profile features which may be mistaken for compaction on this site):**

---

12. **Functional/Structural Groups (list in order of descending dominance by above-ground annual-production or live foliar cover using symbols: >>, >, = to indicate much greater than, greater than, and equal to):**

Dominant:

Sub-dominant:

Other:

Additional:

---

13. **Amount of plant mortality and decadence (include which functional groups are expected to show mortality or decadence):**
- 

14. **Average percent litter cover (%) and depth ( in):**
- 

15. **Expected annual annual-production (this is TOTAL above-ground annual-production, not just forage annual-production):**
- 

16. **Potential invasive (including noxious) species (native and non-native). List species which BOTH characterize degraded states and have the potential to become a dominant or co-dominant species on the ecological site if their future establishment and growth is not actively controlled by management interventions. Species that become dominant for only one to several years (e.g., short-term response to drought or wildfire) are not invasive plants. Note that unlike other indicators, we are describing what is NOT expected in the reference state for the ecological site:**
- 

17. **Perennial plant reproductive capability:**
-