

# Ecological site R057XY005MN

## Open Peatland

Last updated: 10/03/2023  
Accessed: 04/27/2024

---

### General information

**Provisional.** A provisional ecological site description has undergone quality control and quality assurance review. It contains a working state and transition model and enough information to identify the ecological site.

### MLRA notes

Major Land Resource Area (MLRA): 057X–Northern Minnesota Gray Drift

The Northern Minnesota Gray Drift (57) is located within the Northern Lakes Forest and Forage Region. This area is entirely in north-central Minnesota and makes up about 9,785 square miles (Figure 1). The entire area is covered by Wisconsin-age glacial drift. The glacial deposits are from four major ice lobes—Des Moines, Rainy, Superior, and Wadena. The landscape developed through a series of glaciations and the subsequent retreating and wasting of the ice sheets, which resulted in a complex pattern of moraines, outwash plains, drumlins, lake plains and drainages. Lakes, ponds and marshes are common. The thickness of the glacial till ranges from 90 to 185 meters. Some areas of these deposits are overlain by outwash or lacustrine sediments. Some depressional areas have an accumulation of organic matter. The organic deposits are more than 2.5 meters thick in some areas. Elevation ranges from 300 to 500 meters across the area. (USDA-NRCS 2006)

The dominant soil orders in this MLRA are Alfisols, Entisols, and Histisols, with some Mollisols in the westernmost part of the area. The soils in the area have a frigid soil temperature regime; aquic or udic soil moisture regime, and mixed mineralogy. Their natural drainage class is related to landscape position. In general, the Alfisols formed in till on moraines, Entisols formed in outwash on moraines and outwash plains, and Histisols formed in organic material over outwash or till on moraines or outwash plains. (USDA-NRCS 2006)

### Classification relationships

Major Land Resource Area (MLRA): Northern Minnesota Gray Drift (57) (USDA Handbook 296, 2006)

USFS Subregions: Northern Minnesota Drift & Lake Plain Section (212N); Chippewa Plains Subsection (212Na), Pine Moraines & Outwash Plains Subsections (212Nc), St. Louis Moraines Subsection (212Nb); Minnesota & NE Iowa Morainal Section (222M); Hardwood Hills Subsection (222Ma); Northern Superior Uplands Section (212L); Nashwauk Uplands Subsection (212Lc); Northern Minnesota & Ontario Peatlands Section (212M); Littlefork-Vermillion Uplands Subsection (212Ma) (Cleland et al. 2007).

US EPA Level IV Ecoregion: Itasca and St. Louis Moraines (50q); Chippewa Plains (50r); Nashwauk/Marcell Moraines and Uplands (50s); Alexandria Moraines and Detroit Lakes Outwash Plain (51j); McGrath Till Plain and Drumlins (51k); Wadena/Todd Drumlins and Osakis Till Plain (51l) (U.S. Environmental Protection Agency, 2013)

### Ecological site concept

Open Peatland sites are widespread throughout the entire MLRA 57, and typically occur on level to gently sloping surfaces on all landforms through the area. Soils have greater than 16" of organic material and soil pH values are greater than 4.5.

### Associated sites

R057XY001MN	<b>Marsh</b> Marsh occurs on level or slightly concave landscape positions in closed depressions, shallow wetland basins, drainage ways, and adjacent to open water. They are very poorly drained soils and are frequently inundated with water for long durations. Soil surface textures are typically muck or mucky-modified surface layers over variable parent materials.
F057XY003MN	<b>Peatland</b> Peatland occurs in shallow wetland basins, closed depressions, and along drainage ways. Soils are occasionally ponded with standing water in spring but tend to recede by late summer. Soil surface layers are typically muck 8 to 16" thick over variable parent materials.
F057XY006MN	<b>Forested Peatland</b> Forested Peatland occurs on level to gently sloping surfaces. Soils have greater than 16" of organic material and soil pH values are greater than 4.5. This site has a water table typically below the peat surface that drops during the summer to allow for the establishment of significant tree cover.

### Similar sites

F057XY003MN	<b>Peatland</b> Peatland occurs in shallow wetland basins, closed depressions, and along drainage ways. Soils are occasionally ponded with standing water in spring but tend to recede by late summer. Soil surface layers are typically muck 8 to 16" thick over variable parent materials.
-------------	---

**Table 1. Dominant plant species**

Tree	(1) <i>Larix laricina</i>
Shrub	(1) <i>Salix pedicellaris</i> (2) <i>Chamaedaphne calyculata</i>
Herbaceous	(1) <i>Carex lasiocarpa</i> (2) <i>Comarum palustre</i>

### Physiographic features

Open Peatland sites are widespread throughout the entire MLRA 57, and typically occur on level to gently sloping surfaces on all landforms through the area, depressions, flood plains, moraines and outwash plains.

**Table 2. Representative physiographic features**

Landforms	(1) Depression (2) Moraine (3) Outwash plain (4) Channel (5) Flood plain
Runoff class	Low
Flooding frequency	None to occasional
Ponding frequency	None to occasional
Elevation	590–2,034 ft
Slope	0–10%
Water table depth	0 in
Aspect	Aspect is not a significant factor

### Climatic features

In general, MLRA 57 has cold winters and warm summers. About 65 percent of the annual precipitation falls as rain during the 5-month growing season (May through September), and an additional 18 percent falls as snow.

**Table 3. Representative climatic features**

Frost-free period (characteristic range)	96-115 days
Freeze-free period (characteristic range)	132-141 days
Precipitation total (characteristic range)	26-30 in
Frost-free period (actual range)	82-127 days
Freeze-free period (actual range)	125-153 days
Precipitation total (actual range)	25-30 in
Frost-free period (average)	104 days
Freeze-free period (average)	136 days
Precipitation total (average)	28 in

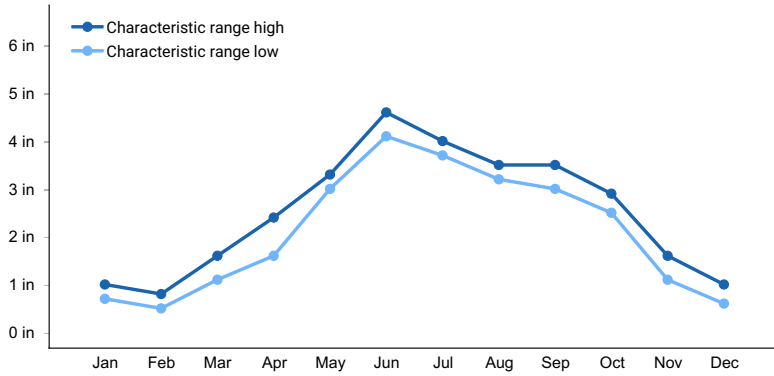

Figure 1. Monthly precipitation range

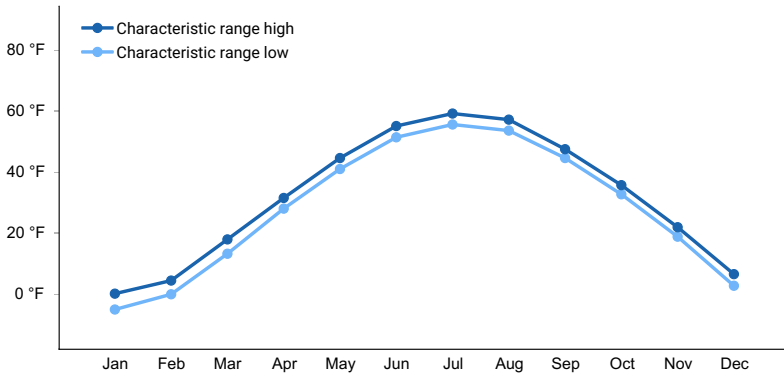

Figure 2. Monthly minimum temperature range

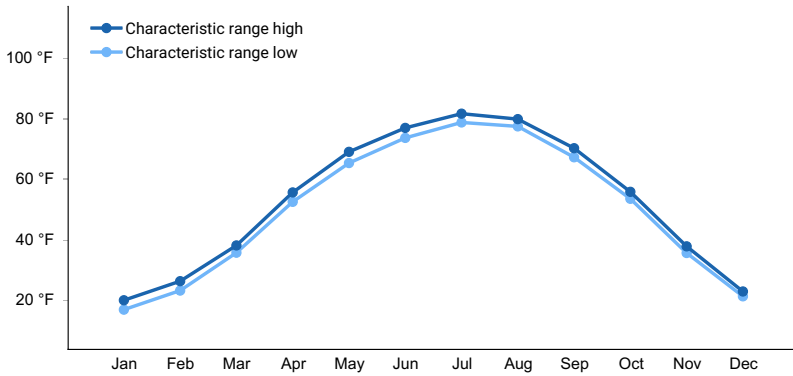
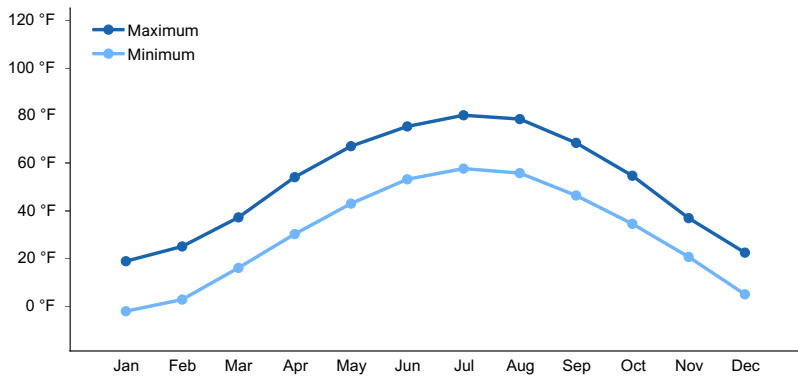
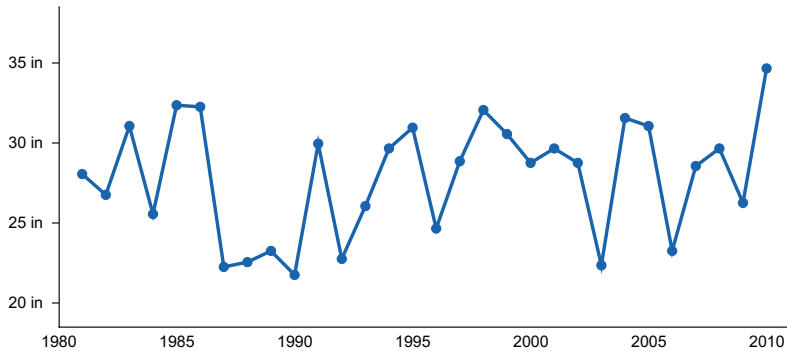

Figure 3. Monthly maximum temperature range



**Figure 4. Monthly average minimum and maximum temperature**



**Figure 5. Annual precipitation pattern**

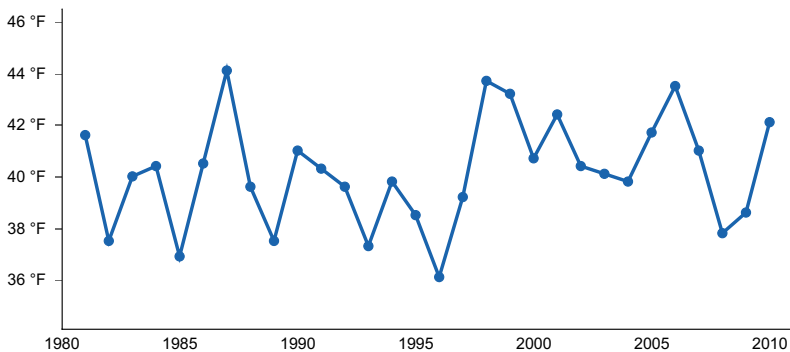

**Figure 6. Annual average temperature pattern**

### Climate stations used

- (1) RED LAKE INDIAN AGCY [USC00216795], Ponemah, MN
- (2) FOSSTON 1 E [USC00212916], Fosston, MN
- (3) BLACKDUCK [USC00210809], Blackduck, MN
- (4) DEEP PORTAGE [USC00212050], Backus, MN
- (5) DETROIT LAKES 1 NNE [USC00212142], Detroit Lakes, MN
- (6) MARCELL 5NE [USC00215175], Bigfork, MN
- (7) COLLEGEVILLE ST JOHN [USC00211691], Avon, MN
- (8) LONG PRAIRIE [USC00214861], Long Prairie, MN

### Influencing water features

These sites are typically groundwater recharged and are highly influenced by the abundant concentration of minerals such as calcium found in the ground water that has percolated through the highly calcareous parent material that typically occurs throughout the region. These sites have minimal slopes with minimal runoff potential.

### Wetland description

Under the Cowardin System of Wetland Classification, or National Wetlands Inventory (NWI), these sites could be classified as:

- 1) Palustrine, scrub-shrub, broad-leaved deciduous, saturated, or
- 2) Palustrine, moss-lichen, saturated, or
- 3) Palustrine, scrub-shrub, broad-leaved evergreen, saturated, or
- 4) Palustrine emergent, persistent, saturated

NRCS Hydrologic group: A/D, B/D, C/D.

Many of these sites have hydric soils.

## Soil features

Common soil series of this site include: Bowstring, Cathro, Seelyville, Haslie, and Tacoosh. Open peatlands have minimal runoff potential, deep soils, and often are histosols. Surface's are often made up of herbaceous organic material or other highly decomposed organic material. These sites are very poorly drained.

**Table 4. Representative soil features**

Parent material	(1) Herbaceous organic material (2) Organic material
Surface texture	(1) Muck (2) Mucky peat (3) Peat
Drainage class	Very poorly drained
Permeability class	Moderately slow
Depth to restrictive layer	72 in
Soil depth	80 in
Surface fragment cover <=3"	0%
Surface fragment cover >3"	0%
Available water capacity (Depth not specified)	12–21 in
Soil reaction (1:1 water) (Depth not specified)	5.1–8.4
Subsurface fragment volume <=3" (Depth not specified)	2–7%
Subsurface fragment volume >3" (Depth not specified)	1–2%

## Ecological dynamics

Open Peatland sites are widespread throughout the entire MLRA 57, and typically occur on level to gently sloping surfaces on all landforms through the area. Soils have greater than 16" of organic material and soil pH values are greater than 4.5. The organic material ranges in decomposition from muck, mucky peat to peat textures underlain by variable parent material. These sites are typically groundwater recharged and are highly influenced by the abundant concentration of minerals such as calcium found in the ground water that has percolated through the highly calcareous parent material that typically occurs throughout the region. Plant communities typical with Open Peatland tend to be dominated by sedges, ericaceous shrubs, bog willow, or bog birch.

## State and transition model

### Ecosystem states

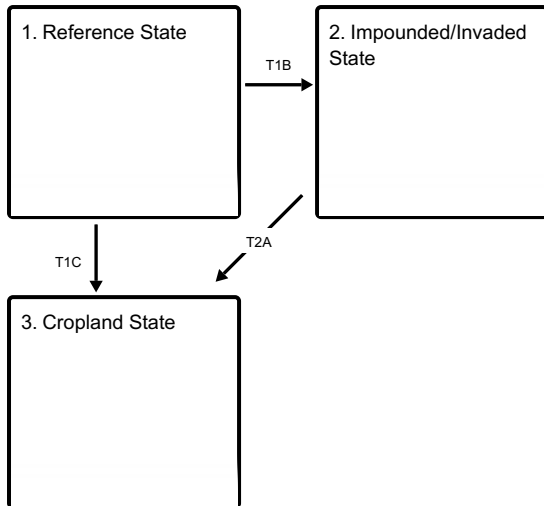

**T1B** - Impoundment of water on-site, maintenance of water on-site, and/or establishment of invasive species

**T1C** - Tile drainage, tilling, seeding, herbicide

**T2A** - Tile drainage, tilling, seeding, herbicide

### State 1 submodel, plant communities

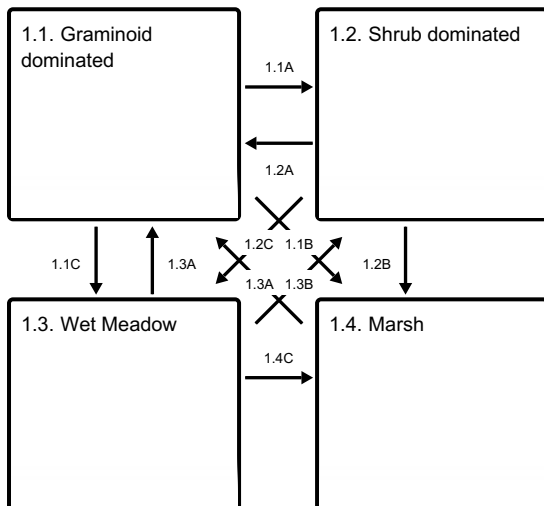

**1.1A** - Lack of fire and/or periodic drought

**1.1C** - Seasonal water oscillations becomes high compared to the more stable groundwater

**1.1B** - Beaver dam off-site restricts water flow or contributes to ponding on-site

**1.2A** - Fire, higher than average precipitation, and/or decreased frequency of inundation by surface runoff.

**1.2C** - Seasonal water oscillations becomes high compared to the more stable groundwater.

**1.2B** - Beaver dam off-site restricts water flow or contributes to ponding on-site

**1.3A** - Accumulating of peat and water levels stabilize (but still remain fairly high) with stable groundwater influence.

**1.3B** - Lack of fire and/or periodic drought

**1.4C** - Increased beaver dam off-site restricts water flow and contributes to ponding on-site or fire.

**1.3A** - Removal of beaver or beaver dam

### State 2 submodel, plant communities

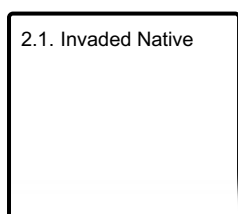

## State 1

### Reference State

This community is dominated by fine-leaved sedges, graminoids, and shrubs. Soils are mucky peat or peat.

#### Dominant plant species

- tamarack (*Larix laricina*), tree
- black spruce (*Picea mariana*), tree
- bog birch (*Betula pumila*), shrub
- leatherleaf (*Chamaedaphne calyculata*), shrub
- woollyfruit sedge (*Carex lasiocarpa*), grass
- bluejoint (*Calamagrostis canadensis*), grass

### Community 1.1

#### Graminoid dominated

The peatland system of Minnesota forms a mosaic of plant community variations across the landscape. Community 1.1. describes those area that are dominated by a diversity of wet-tolerant graminoid species. Multiple species of native sedges are present on site. The shrub layer is variable but usually sparse to scattered.

#### Dominant plant species

- bog willow (*Salix pedicellaris*), shrub
- bluejoint (*Calamagrostis canadensis*), grass
- Northwest Territory sedge (*Carex utriculata*), grass
- woollyfruit sedge (*Carex lasiocarpa*), grass
- upright sedge (*Carex stricta*), grass
- hairy sedge (*Carex lacustris*), grass

### Community 1.2

#### Shrub dominated

Water depth, microtopography, peat depth, and other soil characteristics will influence the plant community composition.

#### Dominant plant species

- leatherleaf (*Chamaedaphne*), shrub
- bog birch (*Betula pumila*), shrub
- speckled alder (*Alnus incana ssp. rugosa*), shrub
- sweetgale (*Myrica*), shrub
- bog Labrador tea (*Ledum groenlandicum*), shrub
- redosier dogwood (*Cornus sericea*), shrub

### Community 1.3

#### Wet Meadow

Dominated by dense cover of broad-leaved graminoids or tall shrubs.

#### Dominant plant species

- willow (*Salix*), shrub
- speckled alder (*Alnus incana ssp. rugosa*), shrub
- bluejoint (*Calamagrostis canadensis*), grass
- upright sedge (*Carex stricta*), grass
- Northwest Territory sedge (*Carex utriculata*), grass
- hairy sedge (*Carex lacustris*), grass
- marsh bellflower (*Campanula aparinoides*), other herbaceous
- tufted loosestrife (*Lysimachia thyrsiflora*), other herbaceous

## **Community 1.4 Marsh**

Zones within this site may have areas that can be described as a sedge-cattail marsh. Areas of open water may be present. Areas of deeper water will contain floating and submerged forbs such as duckweed (*Lemna* spp.), smartweed (*Polygonum* spp.), and American white water lily (*Nymphaea odorata*).

### **Dominant plant species**

- bluejoint (*Calamagrostis canadensis*), grass
- woolgrass (*Scirpus cyperinus*), grass
- broadleaf cattail (*Typha latifolia*), other herbaceous
- duckweed (*Lemna*), other herbaceous
- American white waterlily (*Nymphaea odorata*), other herbaceous

## **Pathway 1.1A Community 1.1 to 1.2**

Lack of fire and/or periodic drought. Also, if frequency of inundation by surface runoff or rising lake levels increases (Minnesota Department of Natural Resources (2003)). Perhaps the stability of water level favors graminoids but the stochastic nature of fluctuating water favors shrubs.

## **Pathway 1.1C Community 1.1 to 1.3**

Plant community 1.1 to 1.4 conversion occurs when substrate changes from one that is sphagnum peat dominated to one that is more sedimentary peat, sapric peat, muck or mineral soil dominated. This can occur when seasonal water oscillations becomes high compared to the more stable groundwater influenced plant communities. Beaver dam off-site restricts water flow or contributes to ponding on-site.

## **Pathway 1.1B Community 1.1 to 1.4**

Beaver dam off-site restricts water flow or contributes to ponding on-site

## **Pathway 1.2A Community 1.2 to 1.1**

Fire, higher than average precipitation. and/or decreased frequency of inundation by surface runoff.

## **Pathway 1.2C Community 1.2 to 1.3**

Plant community 1.1 to conversion 1.4 occurs when substrate changes from one that is sphagnum peat dominated to one that is more sedimentary peat, sapric peat, muck or mineral soil dominated. This can occur when seasonal water oscillations becomes high compared to the more stable groundwater influenced plant communities. Beaver damming can cause this to happen.

## **Pathway 1.2B Community 1.2 to 1.4**

Beaver dam off-site restricts water flow or contributes to ponding on-site

## **Pathway 1.3A Community 1.3 to 1.1**

The wet meadow, if it changes to be actively accumulating peat and water levels stabilize (but still remain fairly



high) with stable groundwater influence, can transition to plant community 1.1.

**Context dependence.** n.

**Pathway 1.3B**  
**Community 1.3 to 1.2**

Lack of fire and/or periodic drought

**Pathway 1.4C**  
**Community 1.3 to 1.4**

Increased beaver dam off-site restricts water flow and contributes to ponding on-site or fire.

**Pathway 1.3A**  
**Community 1.4 to 1.1**

Removal of beaver or beaver dam

**State 2**  
**Impounded/Invaded State**

The plant community is still an open peatland dominated by shrubs and graminoids; however, invasive species are now present on site and will increase with the absence of management inputs.

**Community 2.1**  
**Invaded Native**

Native species with invaders starting to emerge.

**Dominant plant species**

- bluejoint (*Calamagrostis canadensis*), grass
- sedge (*Carex*), grass
- reed canarygrass (*Phalaris arundinacea*), grass
- hairy sedge (*Carex lacustris*), grass
- Northwest Territory sedge (*Carex utriculata*), grass
- wheat sedge (*Carex atherodes*), grass
- American white waterlily (*Nymphaea odorata*), other herbaceous
- watershield (*Brasenia schreberi*), other herbaceous
- pondweed (*Potamogeton*), other herbaceous
- hybrid cattail (*Typha xglauca*), other herbaceous

**State 3**  
**Cropland State**

Annual Crops

**Transition T1B**  
**State 1 to 2**

Impoundment of water on-site, maintenance of water on-site, and/or establishment of invasive species

**Transition T1C**  
**State 1 to 3**

Tile drainage, tilling, seeding, herbicide

## **Transition T2A**

### **State 2 to 3**

Tile drainage, tilling, seeding, herbicide

### **Additional community tables**

### **Inventory data references**

Information presented was derived from Minnesota Department of Natural Resources Field Guide to the Native Plant Communities of Minnesota, USDA-NRCS soil survey information, and USDA Plants Database.

### **Other references**

Cleland, D.T.; Freeouf, J.A.; Keys, J.E., Jr.; Nowacki, G.J.; Carpenter, C; McNab, W.H. 2007. Ecological Subregions: Sections and Subsections of the Conterminous United States.[1:3,500,000], Sloan, A.M., cartog. Gen. Tech. Report WO-76. Washington, DC: U.S. Department of Agriculture, Forest Service.

Eggers, Steve D. and Donald M. Reed. 1997. Wetland Plants and Plant Communities of Minnesota and Wisconsin. U.S. Army Corps of Engineers, St. Paul District.

Minnesota Department of Natural Resources. 2003. Field Guide to the Native Plant Communities of Minnesota: The Laurentian Mixed Forest Province. Ecological Land Classification Program, Minnesota County Biological Survey, and Natural Heritage and Nongame Research Program. MNDNR St. Paul, MN.

Soil Survey Staff, Natural Resources Conservation Service, United States Department of Agriculture. Official Soil Series Descriptions. Available online. Accessed March 2018.

United States Department of Agriculture, Natural Resources Conservation Service. 2006. Land Resource Regions and Major Land Resource Areas of the United States, the Caribbean, and the Pacific Basin. U.S. Department of Agriculture Handbook 296.

USDA, NRCS. 2018. The PLANTS Database (<http://plants.usda.gov>, 27 March 2018). National Plant Data Team, Greensboro, NC 27401-4901 USA.

U.S. Environmental Protection Agency. 2013, Level III and IV ecoregions of the continental United States: Corvallis, Oregon, U.S. EPA, National Health and Environmental Effects Research Laboratory, map scale 1:3,000,000, <https://www.epa.gov/eco-research/level-iii-and-iv-ecoregions-continental-united-states>.

Relationship to Other Established Classifications:

MN DNR Native Plant Community (MN DNR, 2003); the reference community of this Provisional Ecological Site is most similar to:

OPn81 Northern Shrub Shore Fen

OPn91 Prairie Rich Fen

OPn92 Northern Rich Fen (Basin)

### **Contributors**

Ezra Hoffman, Ecological Site Specialist for North Central Region  
Kade Anderson, Ecological Site Specialist for North Central Region  
Patty Burns, Soil Scientist, USDA-NRCS-Bemidji, MN.  
Stacey Clark, Regional Ecologist, USDA-NRCS-St.Paul, MN.

### **Approval**

Suzanne Mayne-Kinney, 10/03/2023

## Acknowledgments

MLRA 57 technical team completed in 2022.

## Rangeland health reference sheet

Interpreting Indicators of Rangeland Health is a qualitative assessment protocol used to determine ecosystem condition based on benchmark characteristics described in the Reference Sheet. A suite of 17 (or more) indicators are typically considered in an assessment. The ecological site(s) representative of an assessment location must be known prior to applying the protocol and must be verified based on soils and climate. Current plant community cannot be used to identify the ecological site.

Author(s)/participant(s)	
Contact for lead author	
Date	04/27/2024
Approved by	Suzanne Mayne-Kinney
Approval date	
Composition (Indicators 10 and 12) based on	Annual Production

## Indicators

1. **Number and extent of rills:**

---

2. **Presence of water flow patterns:**

---

3. **Number and height of erosional pedestals or terracettes:**

---

4. **Bare ground from Ecological Site Description or other studies (rock, litter, lichen, moss, plant canopy are not bare ground):**

---

5. **Number of gullies and erosion associated with gullies:**

---

6. **Extent of wind scoured, blowouts and/or depositional areas:**

---

7. **Amount of litter movement (describe size and distance expected to travel):**

---

8. **Soil surface (top few mm) resistance to erosion (stability values are averages - most sites will show a range of values):**

---

9. **Soil surface structure and SOM content (include type of structure and A-horizon color and thickness):**

---

10. **Effect of community phase composition (relative proportion of different functional groups) and spatial distribution on infiltration and runoff:**

---

11. **Presence and thickness of compaction layer (usually none; describe soil profile features which may be mistaken for compaction on this site):**

---

12. **Functional/Structural Groups (list in order of descending dominance by above-ground annual-production or live foliar cover using symbols: >>, >, = to indicate much greater than, greater than, and equal to):**

Dominant:

Sub-dominant:

Other:

Additional:

---

13. **Amount of plant mortality and decadence (include which functional groups are expected to show mortality or decadence):**

---

14. **Average percent litter cover (%) and depth ( in):**

---

15. **Expected annual annual-production (this is TOTAL above-ground annual-production, not just forage annual-production):**

---

16. **Potential invasive (including noxious) species (native and non-native). List species which BOTH characterize degraded states and have the potential to become a dominant or co-dominant species on the ecological site if their future establishment and growth is not actively controlled by management interventions. Species that become dominant for only one to several years (e.g., short-term response to drought or wildfire) are not invasive plants. Note that unlike other indicators, we are describing what is NOT expected in the reference state for the ecological site:**

---

17. **Perennial plant reproductive capability:**

---