

## Ecological site R058AY716MT Sandy Steep 10-14

Last updated: 8/29/2024  
Accessed: 11/21/2024

---

### General information

**Provisional.** A provisional ecological site description has undergone quality control and quality assurance review. It contains a working state and transition model and enough information to identify the ecological site.

### MLRA notes

Major Land Resource Area (MLRA): 058A–Northern Rolling High Plains, Northern Part

MLRA 058A, Northern Rolling High Plains (Northern Part), is an expansive and agriculturally and ecologically significant area encompassing 26 counties in southeast Montana (99 percent) and northeast Wyoming (1 percent). It stretches approximately 290 miles from east to west and 220 miles from north to south and comprises approximately 42,350 square miles (26,875,928 acres). The area is within the Missouri Plateau, Unglaciaded, Section of the Great Plains Province of the Interior Plains. It is an area of old plateaus and terraces that have been eroded. Slopes generally are gently rolling to steep, and wide belts of steeply sloping badlands border a few of the larger river valleys. In some areas flat-topped, steep-sided buttes rise sharply above the general level of the plains. Elevations generally range from 1,950 to 3,280 feet, increasing from east to west and from north to south.

Tertiary continental shale, siltstone, and sandstone of the Fort Union Formation underlie the eastern one-third to one-half of this area. Marine and continental sediments of the Cretaceous Montana Group underlie the rest of the MLRA, generally at the higher elevations. There are also younger Cretaceous sediments of the Livingston Group occurring between the higher elevation Montana Group sediments and the lower elevation Tertiary sediments. The dominant soil orders in MLRA 058A are Entisols and Inceptisols. The soils in the area dominantly have a frigid soil temperature regime, an ustic soil moisture regime, and mixed or smectitic mineralogy. They range from shallow to very deep and are generally well drained and clayey or loamy.

The area primarily supports native prairie vegetation characterized by a variety of cool-season and warm-season graminoids, forbs, and shrubs. In the western portion of the area, cool-season grasses such as western wheatgrass and bluebunch wheatgrass are dominant but, in the eastern portion of the area, warm-season grasses such as little bluestem and sideoats grama become dominant. Wyoming big sagebrush, silver sagebrush, and fringed sagewort are common shrub species throughout the area. Forested areas occur in rough hilly areas and river breaks, particularly in areas with higher precipitation. Common tree species are ponderosa pine and Rocky Mountain juniper with scattered pockets of Douglas fir.

More than 75 percent of this MLRA is native rangeland utilized for livestock production and more than 50 percent of the MLRA consists of privately-owned ranches. Approximately 15 percent of the MLRA is used as cropland. Other land uses including forestland, urban development, water, and other uses combine for less than 10 percent of the total land use.

### Classification relationships

Classification relationships

NRCS Soil Geography Hierarchy

- Land Resource Region: Western Great Plains
- Major Land Resource Area (MLRA): 058A Northern Rolling High Plains, Northern Part

National Hierarchical Framework of Ecological Units (Cleland et al., 1997; McNab et al., 2007)

- Domain: Dry
- Division: Temperate Steppe
- Province: Great Plains-Palouse Dry Steppe Province (331)
- Section: North Central Highlands (331K) and Powder River Basin (331G)

National Vegetation Classification Standard (Federal Geographic Data Committee, 2008)

- Class: Mesomorphic Shrub and Herb Vegetation Class (2)
- Subclass: Temperate and Boreal Grassland and Shrubland Subclass (2.B)
- Formation: Temperate Grassland and Shrubland Formation (2.B.2)
- Division: *Andropogon gerardii* - *Pascopyrum smithii* - *Bouteloua gracilis* Grassland and Shrubland Division (2.B.2.Nb)
- Macrogroup: *Andropogon hallii* - *Calamovilfa longifolia* - *Artemisia filifolia* Great Plains Sand Grassland and Shrubland Macrogroup (2.B.2.Nb.4)
- Group: *Artemisia filifolia* / *Calamovilfa longifolia* - *Yucca glauca* Sand Shrubland Group (2.B.2.Nb.4.a)

EPA Ecoregions

- Level 1: Great Plains (9)
- Level 2: West-Central Semi-Arid Prairies (9.3)
- Level 3: Northwestern Great Plains (9.3.3)
- Level 4: Montana Central Grasslands (43n), River Breaks (43c), and Pine Scoria Hills (43p)

## Ecological site concept

This ecological site occurs on moderately steep to steep hills and ridges at elevations ranging from 1,900 to 3,500 feet and on slopes ranging from 15 to 45 percent. This site occurs on all aspects and aspect can be significant. The soils of this ecological site are moderately deep to very deep and are well drained to somewhat excessively drained. The soil textures are typically sand, loamy sand, or sandy loam.

## Associated sites

R058AY710MT	<b>Loamy Steep 10-14</b> This site occurs on moderately steep to steep uplands adjacent to the Sandy Steep ecological site and on similar slopes and landscape positions.
R058AY715MT	<b>Sandy 10-14</b> This site occurs on nearly level to moderately steep uplands adjacent to the Sandy Steep ecological site. It occurs in summit or footslope positions where slopes are less than 15 percent and depth to bedrock is greater than 20 inches.
R058AY717MT	<b>Shallow 10-14</b> This site occurs on nearly level to steeply sloping uplands that are adjacent to the Sandy Steep ecological site. It occurs on upper backslope, crest, or summit positions and is often associated with rock outcrops.

## Similar sites

R058AY710MT	<b>Loamy Steep 10-14</b> This site differs from the Sandy Steep ecological site in that soils are finer textures. The soil textures typically vary from fine sandy loam to clay loam and contain less than 32 percent clay.
R058AY715MT	<b>Sandy 10-14</b> This site differs from the Sandy Steep ecological site in that slopes are less than 15 percent.
R058AY717MT	<b>Shallow 10-14</b> This site differs from the Sandy Steep ecological site in that soils are 10 to 20 inches deep to bedrock, lithic, or paralithic root restrictive layer.

Table 1. Dominant plant species

Tree	Not specified
Shrub	(1) <i>Yucca glauca</i>

Herbaceous	(1) <i>Calamovilfa longifolia</i> (2) <i>Hesperostipa comata</i>
------------	---

## Physiographic features

This ecological site occurs on moderately steep to steep hills and ridges. Slopes typically range from 15 to 45 percent. This site occurs on all aspects. Aspect can be significant factor.

**Table 2. Representative physiographic features**

Landforms	(1) Hill (2) Ridge
Runoff class	Low to high
Flooding frequency	None
Ponding frequency	None
Elevation	579–1,067 m
Slope	15–45%
Aspect	Aspect is not a significant factor

## Climatic features

MLRA 058A is a semi-arid region and is considered to have a continental climate characterized by cold winters, hot summers, low humidity, light rainfall, and much sunshine. The climate is the result of the MLRA's location in the geographic center of North America. Temperatures can be extreme. The average annual temperature is 41 to 49 degrees Fahrenheit. Summer daytime temperatures are typically quite warm, generally averaging in the lower to mid 80 degree range for July and August. Summertime temperatures will typically reach 100 degrees or more at some point during the summer and can reach 90 degrees during any month between May and September. Conversely, winter temperatures can be cold, averaging in the lower teens or less for December and January. There will typically be several days of below zero temperatures each winter. It is not uncommon for temperatures to reach 30 to 40 degrees below zero, or even colder, most any winter.

During an average year, 70 to 75 percent of the annual precipitation falls between April and September, which are the primary growing season months. Most of the rainfall occurs as frontal storms early in the growing season during the months of May and June. Some high-intensity, convective thunderstorms occur in July and August, and some rainfall occurs in autumn. Later summer precipitation is greater in the eastern portion of the MLRA, which effects plant community composition. Winter precipitation occurs as snow although snowfall is not heavy, averaging about 39 inches annually, and snow cover is typically 1 to 3 inches. Heavy snowfall occurs infrequently, usually late in the winter or early spring. The average annual precipitation ranges from 8 to 22 inches but is typically 11 to 17 inches throughout most of the area. This site occurs in the lower range of 10 to 14 inches of precipitation. Precipitation fluctuates widely from year to year and severe drought occurs 2 out of 10 years on average.

There are few natural barriers on the northern Great Plains and the winds move freely across the plains and account for rapid changes in temperature. Spring can be windy throughout the MLRA, with winds averaging over 10 mph about 15 percent of the time. Speeds of 50 mph or stronger can occasionally occur. During the winter months, the western half of the MLRA commonly experiences Chinook winds, which are strong west to southwest surface winds accompanied by abrupt increases in temperature. The Chinook winds are strongest on the western boundary of the MLRA near the Rocky Mountain foothills and decrease eastward. In addition to producing damaging winds, prolonged Chinook episodes can result in drought or vegetation kills due to a reaction of plants to a "false spring" (Oard, 1993).

For local climate station information, refer to <https://wrcc.dri.edu/summary/Climsmemt.html>.

**Table 3. Representative climatic features**

Frost-free period (characteristic range)	85-150 days
--	-------------

Freeze-free period (characteristic range)	115-170 days
Precipitation total (characteristic range)	254-356 mm
Frost-free period (average)	125 days
Freeze-free period (average)	145 days
Precipitation total (average)	330 mm

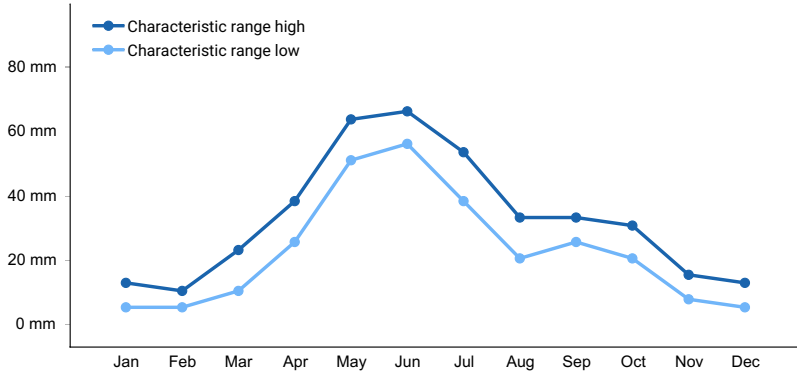

**Figure 1. Monthly precipitation range**

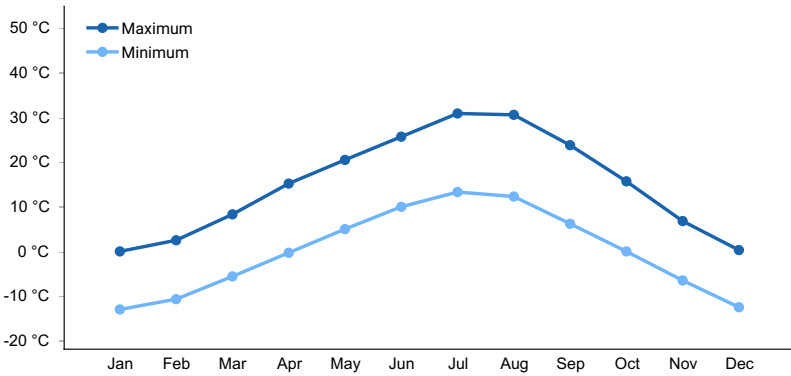

**Figure 2. Monthly average minimum and maximum temperature**

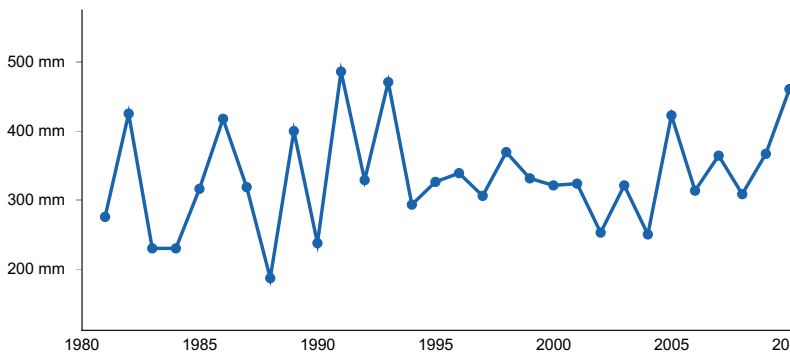

**Figure 3. Annual precipitation pattern**

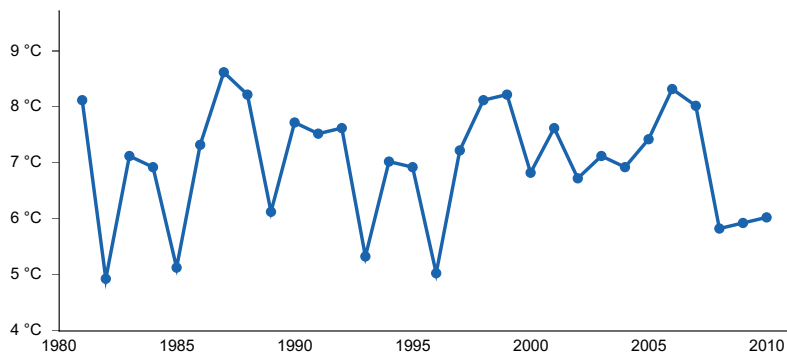

**Figure 4. Annual average temperature pattern**

## Climate stations used

- (1) RAPELJE [USC00246862], Rapelje, MT
- (2) HYSHAM 25 SSE [USC00244364], Bighorn, MT
- (3) BRANDENBERG [USC00241084], Rosebud, MT
- (4) TERRY 21 NNW [USC00248169], Terry, MT
- (5) BLOOMFIELD 5 NNE [USC00240923], Bloomfield, MT
- (6) GLENDIVE [USC00243581], Glendive, MT
- (7) POWDERVILLE 8 NNE [USC00246691], Volborg, MT
- (8) JORDAN 23 ENE [USC00244530], Jordan, MT
- (9) FT PECK PWR PLT [USC00243176], Fort Peck, MT
- (10) CIRCLE [USC00241758], Circle, MT
- (11) BROCKWAY 3 WSW [USC00241169], Brockway, MT
- (12) MILES CITY F WILEY FLD [USW00024037], Miles City, MT
- (13) MIZPAH 4 NNW [USC00245754], Ismay, MT
- (14) SAND CREEK [USC00247342], Roy, MT
- (15) ROCK SPRINGS [USC00247136], Angela, MT
- (16) COHAGEN [USC00241875], Cohagen, MT

## Influencing water features

This is upland ecological site and is not influenced by a water table or run in from adjacent sites. Due to the semi-arid climate in which it occurs, the water budget is normally contained within the soil pedon. Soil moisture is recharged by spring rains, but it but rarely exceeds field capacity in the upper 40 inches before being depleted by evapotranspiration. During intense precipitation events this site may deliver moisture to downslope sites via deep percolation or surface runoff and contribute recharge to a localized area. Moisture loss through evapotranspiration exceeds precipitation for the majority of the growing season and soil moisture is the primary limiting factor for plant production on this ecological site.

## Wetland description

Not Applicable

## Soil features

Soils for this ecological site are typically moderately deep to very deep (greater than 20 inches to bedrock), well drained, and formed in residuum derived from sandstone. Surface horizon textures are typically fine sandy loam or sandy loam. The underlying horizons typically have fine sandy loam or sandy loam textures, but some soils may have layers of loamy sand. The soil temperature regime is primarily frigid, with smaller areas of mesic temperature regime present. The soil moisture regime is aridic ustic. Figure 5 shows a typical soil profile for this ecological site.

Soil Series:	Horizon	Depth	Texture	pH
Twilight	A	0-4	Fine sandy loam	7
	Bw	4-16	Fine sandy loam	7.4
	Bk	16-28	Fine sandy loam	8.4
	Cr	28-60	Weakly cemented sandstone	8.4

Figure 5. Typical Soil Profile

Table 4. Representative soil features

Parent material	(1) Residuum–sandstone
Surface texture	(1) Fine sandy loam (2) Sandy loam
Drainage class	Well drained
Permeability class	Moderate to moderately rapid
Soil depth	51–183 cm
Surface fragment cover <=3"	0%
Surface fragment cover >3"	0%
Available water capacity (0-101.6cm)	3.81–5.08 cm
Calcium carbonate equivalent (38.1-101.6cm)	1–20%
Electrical conductivity (0-101.6cm)	0–4 mmhos/cm
Sodium adsorption ratio (0-101.6cm)	0
Soil reaction (1:1 water) (0-101.6cm)	7–8.4
Subsurface fragment volume <=3" (50.8-101.6cm)	0–9%
Subsurface fragment volume >3" (0-101.6cm)	0%

## Ecological dynamics

Interpretations are primarily based on the Reference state, which is used as a reference in order to understand the original potential of the site. This ecological site developed under the combined influences of climatic conditions, periodic fire activity, grazing by large herbivores, and impacts from small mammals and insects. Changes may occur to the Reference state due to management actions such as improper grazing management, climatic conditions such as drought, and natural events such as multiple fires in close succession. The reference state for this ecological site is dominated by a diversity of medium height, cool-season and warm-season grasses, which are tightly intermixed and well distributed over the site. Various forbs, half-shrubs, and shrubs are common on this site. The Reference state is not necessarily the management goal, as other vegetative states may be considered desired plant communities as long as critical resource concerns are met.

In addition to the Reference state, other plant communities can occur on this site and are usually the result of historic management practices. Long term overgrazing on this ecological site results in a decrease of mid-grasses and more palatable forbs and in an increase of shortgrasses, sedges, and less palatable forbs. Half-shrubs and shrubs increase in the absence of prescribed fire and wildfire. More frequent fire intervals decreases the shrub component resulting in a site dominated by herbaceous species. There are various transitional stages which may occur on this ecological site.

## State and transition model

### Ecosystem states

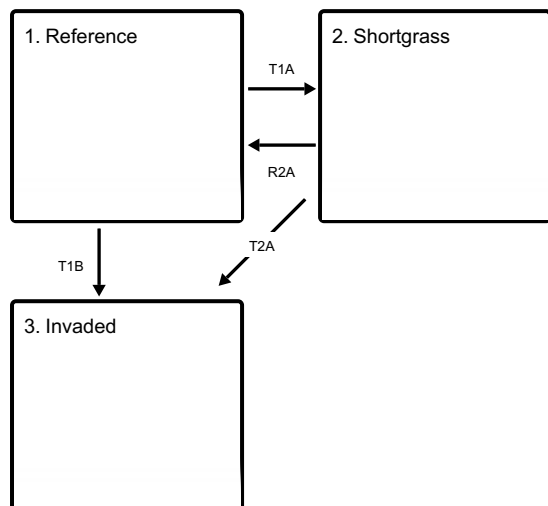

**T1A** - Prolonged drought, improper grazing, or a combination of these factors

**T1B** - Introduction of non-native invasive species (annual bromes, crested wheatgrass, noxious weeds, etc.)

**R2A** - Proper grazing management in combination with rangeland seeding, grazing land mechanical treatment, and timely moisture (management intensive and costly)

**T2A** - Introduction of non-native invasive species (annual bromes, crested wheatgrass, noxious weeds, etc.)

### State 1 submodel, plant communities

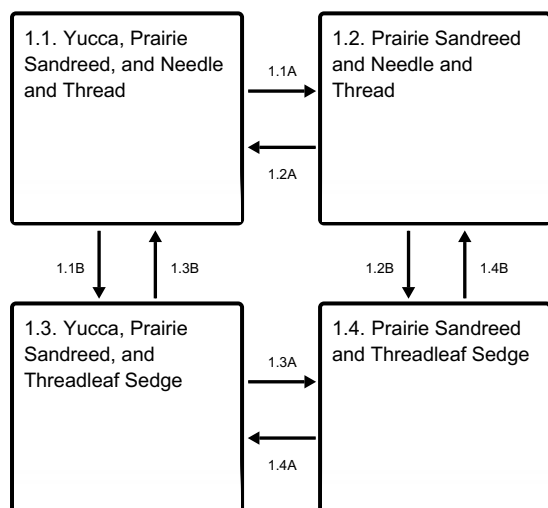

**1.1A** - Prescribed fire and wildfire, mechanical and chemical treatments, and biological processes

**1.1B** - Drought, improper grazing management

**1.2A** - Approximately 30 years post-fire regrowth

**1.2B** - Drought, improper grazing management, multiple fires in close succession

**1.3B** - Normal or above average precip., proper grazing management

**1.3A** - Prescribed fire and wildfire, mechanical and chemical treatments, and biological processes

**1.4B** - Normal or above average precipitation, proper grazing management

**1.4A** - Approximately 30 years post-fire regrowth

### State 2 submodel, plant communities

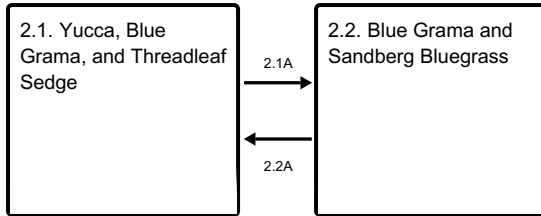

**2.1A** - Prescribed fire and wildfire, mechanical and chemical treatments, and biological processes

**2.2A** - Approximately 30 years post-fire regrowth

### State 3 submodel, plant communities

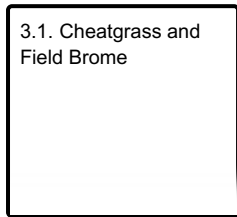

## State 1 Reference

The Reference state for this ecological site consists of four communities and evolved under the combined influences of climatic conditions, periodic fire activity, grazing by large herbivores, and impacts from small mammals and insects. The Reference state is the plant community in which interpretations are primarily based and is used as a reference in order to understand the original potential of the site.

### Dominant plant species

- soapweed yucca (*Yucca glauca*), shrub
- prairie sandreed (*Calamovilfa longifolia*), grass
- needle and thread (*Hesperostipa comata*), grass
- threadleaf sedge (*Carex filifolia*), grass

### Community 1.1 Yucca, Prairie Sandreed, and Needle and Thread

This plant community is characterized by communities comprised of mixed-grasses, sedges, and Wyoming big sagebrush. The predominant species are warm-season and cool-season grasses such as prairie sandreed, little bluestem, sand dropseed, plains muhly, needle and thread, western wheatgrass, sun sedge, and threadleaf sedge. Shortgrasses such as blue grama, Sandberg bluegrass, and prairie Junegrass occur at low canopy cover. Forbs such as purple prairie clover, white prairie clover, black samson, hairy false goldenaster, dotted blazing star, Missouri goldenrod, and aster occur at approximately 10 percent canopy cover. Shrubs and half-shrubs such silver sagebrush, prairie rose, yucca, and prairie sagewort occur at approximately 5 percent canopy cover.

### Community 1.2 Prairie Sandreed and Needle and Thread

This plant community is characterized by a mixed-grass and sedge community comprised of species such as prairie sandreed, little bluestem, sand dropseed, plains muhly, needle and thread, western wheatgrass, sun sedge, and threadleaf sedge. Shortgrasses such as blue grama, Sandberg bluegrass, and prairie Junegrass occur at low canopy cover. Forbs such as purple prairie clover, white prairie clover, black samson, hairy false goldenaster, dotted blazing star, Missouri goldenrod, and aster occur at approximately 10 percent canopy cover. Shrubs and half-shrubs such silver sagebrush, prairie rose, yucca, and prairie sagewort are rare. This community occurs following shrub mortality due to wildfire, prescribed fire, mechanical and chemical treatments, or biological processes and may persist for 30 years or more thereafter (Watts and Wambolt, 1996; Wambolt et. al., 2001).



## **Community 1.3**

### **Yucca, Prairie Sandreed, and Threadleaf Sedge**

This plant community is characterized by a community comprised of shrubs, shortgrasses, sedges, and mid-statured grasses. Shortgrasses and sedges, including blue grama, Sandberg bluegrass, prairie Junegrass, sun sedge, and threadleaf sedge are increasing and mid-statured grasses, including prairie sandreed, little bluestem, sand dropseed, plains muhly, needle and thread, and western wheatgrass are decreasing under this community phase. Shrubs and half-shrubs such silver sagebrush, prairie rose, yucca, and prairie sagewort occur at approximately 5 percent canopy cover. This plant community occurs when site conditions decline due to long-term drought or improper grazing management, and major shrub mortality has not occurred for at least 30 years prior.

## **Community 1.4**

### **Prairie Sandreed and Threadleaf Sedge**

This plant community is characterized by a community comprised of shrubs, shortgrasses, sedges, and mid-statured grasses. Shortgrasses and sedges, including blue grama, Sandberg bluegrass, prairie junegrass, sun sedge, and threadleaf sedge are increasing and mid-statured grasses, including prairie sandreed, little bluestem, sand dropseed, plains muhly, needle and thread, and western wheatgrass are decreasing under this community phase. Shrubs and half-shrubs such silver sagebrush, prairie rose, yucca, and prairie sagewort are rare. This plant community occurs when site conditions decline due to long-term drought or improper grazing management, and shrub mortality due to wildfire, prescribed fire, mechanical and chemical treatments, or biological processes has occurred on the site less than 30 years prior.

## **Pathway 1.1A**

### **Community 1.1 to 1.2**

Community 1.1 will transition to community 1.2 through prescribed fire and wildfire, mechanical and chemical treatments, and biological processes. Shrub cover is greatly reduced and perennial grasses will dominate the site.

## **Pathway 1.1B**

### **Community 1.1 to 1.3**

Drought, improper grazing management such as continuous season-long or year-long grazing, or a combination of these factors can shift community 1.1 to community 1.3. These factors favor an increase in shortgrasses and a decrease in mid-statured grasses (Coupland, 1961; Shay et al., 2001). Shrub cover will be similar to community 1.1

## **Pathway 1.2A**

### **Community 1.2 to 1.1**

Approximately 30 years or more of natural vegetative regrowth will shift community 1.2 to community 1.1. Approximately 30 years or more without major mortality permits shrubs such as Wyoming big sagebrush to recolonize the site.

## **Pathway 1.2B**

### **Community 1.2 to 1.4**

Drought, improper grazing practices such as continuous season-long or year-long grazing, multiple fires in close succession, or a combination of these factors can shift community 1.2 to community 1.3. These factors favor an increase in shortgrasses and a decrease in mid-statured grasses (Coupland, 1961; Shay et al., 2001). Shrub cover will be similar to community 1.2.

## **Pathway 1.3B**

### **Community 1.3 to 1.1**

Approximately 30 years or more following mortality; normal or above-average precipitation and proper grazing management shifts community 1.3 to community 1.1.

### **Pathway 1.3A**

#### **Community 1.3 to 1.4**

Community 1.3 will transition to community 1.4 through prescribed fire and wildfire, mechanical and chemical treatments, and biological processes. Shrub cover is greatly reduced and perennial grasses will dominate the site.

### **Pathway 1.4B**

#### **Community 1.4 to 1.2**

Less than approximately 30 years following mortality; normal or above-average precipitation and proper grazing management shifts community 1.4 to community 1.2.

### **Pathway 1.4A**

#### **Community 1.4 to 1.3**

Approximately 30 years or more of natural vegetative regrowth will shift community 1.4 to community 1.3. Approximately 30 years or more without fire or similar mortality permits shrubs such as Wyoming big sagebrush to recolonize the site.

## **State 2**

### **Shortgrass**

The dynamics of the Shortgrass state are driven by long-term drought, improper grazing management such as continuous season-long or year-long grazing, or a combination of these factors. The Shortgrass state for this ecological site consists of two communities.

#### **Dominant plant species**

- soapweed yucca (*Yucca glauca*), shrub
- blue grama (*Bouteloua gracilis*), grass
- threadleaf sedge (*Carex filifolia*), grass

### **Community 2.1**

#### **Yucca, Blue Grama, and Threadleaf Sedge**

This plant community is characterized by a dominance of shortgrasses and sedges such as blue grama, Sandberg bluegrass, prairie Junegrass, sun sedge, and threadleaf sedge. Mid-statured grasses such as prairie sandreed, little bluestem, sand dropseed, plains muhly, needle and thread, and western wheatgrass are rare or absent. Prairie sagewort may be common. Shrubs such as silver sagebrush, prairie rose, and yucca occur at approximately 5 percent canopy cover. This community phase results in a reduction of soil surface litter, soil organic matter, and infiltration and an increase of soil surface runoff. This plant community is capable of tolerating season-long, heavy grazing and therefore is highly resistant to change.

### **Community 2.2**

#### **Blue Grama and Sandberg Bluegrass**

This plant community is characterized by a complete dominance of shortgrasses and sedges such as blue grama, Sandberg bluegrass, prairie Junegrass, sun sedge, and threadleaf sedge. Mid-statured grasses such as prairie sandreed, little bluestem, sand dropseed, plains muhly, needle and thread, and western wheatgrass are rare or absent. Prairie sagewort may be common. Shrubs such as silver sagebrush, prairie rose, and yucca are rare. This plant community occurs when site conditions decline due to long-term drought or improper grazing management such as continuous season-long or year-long grazing, and shrub mortality due to wildfire, prescribed fire, mechanical and chemical treatments, or biological processes has occurred on the site less than 30 years prior.

### **Pathway 2.1A**

#### **Community 2.1 to 2.2**

Community 2.1 will transition to community 2.2 through prescribed fire and wildfire, mechanical and chemical

treatments, and biological processes. Shrub cover is greatly reduced and perennial grasses will dominate the site.

## **Pathway 2.2A**

### **Community 2.2 to 2.1**

It is estimated that approximately 30 years or more of natural vegetative regrowth could transition community 2.2 to community 2.1. It is possible that this transition could occur over time, however, the processes are not fully understood at this time. Therefore, this pathway is considered hypothetical until further investigation can be completed.

## **State 3**

### **Invaded**

The Invaded state occurs when invasive plant species invade native plant communities and displace the native species. The Invaded state consists of one community.

#### **Dominant plant species**

- cheatgrass (*Bromus tectorum*), grass
- field brome (*Bromus arvensis*), grass

## **Community 3.1**

### **Cheatgrass and Field Brome**

Observations suggest that native species diversity declines significantly when invasive or noxious species exceed approximately 30 percent of the plant community. Non-native, perennial, drought tolerant grasses such as crested wheatgrass, non-native, annual, invasive species such as cheatgrass and field brome, and noxious weed species can eventually dominate the seedbank of this site and displace native species. Reduced plant species diversity, simplified structural complexity, and altered ecological processes result in a state that is substantially departed from the Reference state. The dominance of annual, invasive grasses such as cheatgrass and field brome increases the fire cycle frequency.

## **Transition T1A**

### **State 1 to 2**

Prolonged drought, improper grazing management such as continuous season-long or year-long grazing, or a combination of these factors weaken the resilience of the Reference state and drive its transition to the Shortgrass state. The Reference state transitions to the Shortgrass state when mid-statured graminoids become rare and shortgrasses and sedges such as blue grama, Sandberg bluegrass, and threadleaf sedge dominate the plant community.

## **Transition T1B**

### **State 1 to 3**

The Reference state transitions to the Invaded state when non-native grasses or noxious weeds invade the plant community. Exotic plant species dominate the site in terms of cover and production and site resilience has been substantially reduced. In addition, other rangeland health attributes, such as reproductive capacity of native grasses and soil quality, have been substantially altered from the Reference state.

## **Restoration pathway R2A**

### **State 2 to 1**

Blue grama can resist displacement by other species. A reduction in livestock grazing pressure alone may not be sufficient to reduce the cover of blue grama in the Shortgrass state and mechanical treatments may be necessary. Therefore, returning the Shortgrass state to the Reference state can require considerable cost, energy, and time.

#### **Conservation practices**

## **Transition T2A State 2 to 3**

The Shortgrass state transitions to the Invaded state when non-native grasses, noxious weeds, and other invasive plants invade the Shortgrass state. Exotic plant species dominate the site in terms of cover and production. Site resilience has been substantially reduced.

### **Additional community tables**

#### **Inventory data references**

Specific field data was not obtained for this provisional ecological site description. Existing field data were used in conjunction with a review of the scientific literature and professional experience to approximate the plant communities, states, and transitions. All community phases are considered provisional based on the sources identified in this ecological site description.

#### **Other references**

- Anderson, R.C. 2006. Evolution and origin of the central grassland of North America: Climate, fire, and mammalian grazers. *Journal of the Torrey Botanical Society* 133:626-647.
- Baskin, J.M., and C.C. Baskin. 1981. Ecology of germination and flowering in the weedy winter annual grass *Bromus japonicus*. *Journal of Range Management* 34:369-372.
- Biondini, M.E., and L. Manske. 1996. Grazing frequency and ecosystem processes in a northern mixed prairie, USA. *Ecological Applications* 6:239-256.
- Biondini, M.E., B.D. Patton, and P.E. Nyren. 1998. Grazing intensity and ecosystem processes in a northern mixed-grass prairie, USA. *Ecological Applications* 8:469-479.
- Bloom-Cornelius, I.V. 2011. Vegetation response to fire and domestic and native ungulate herbivory in a Wyoming big sagebrush ecosystem. M.S. thesis, Oklahoma State University. Stillwater, OK.
- Bragg, T.B. 1995. The physical environment of the Great Plains grasslands. In: A. Joern and K.H. Keeler (eds.) *The Changing Prairie*, Oxford University Press, Oxford, pp. 49–81.
- Christian, J.M., and S.D. Wilson. 1999. Long-term ecosystem impacts of an introduced grass in the Northern Great Plains. *Ecology* 80:2397-2407.
- Cleland, D.T., et al. 1997. National hierarchical framework of ecological units. In: M.S. Boyce and A. Haney (eds.) *Ecosystem Management Applications for Sustainable Forest and Wildlife Resources*, Yale University Press, New Haven, CT.
- Coupland, R.T. 1950. Ecology of the mixed prairie of Canada. *Ecological Monographs* 20:271-315.
- Coupland, R.T. 1958. The effects of fluctuations in weather upon the grasslands of the Great Plains. *Botanical Review* 24:273-317.
- Coupland, R.T. 1961. A reconsideration of grassland classification in the Northern Great Plains of North America. *Journal of Ecology* 49:135-167.
- Coupland, R.T., and R.E. Johnson. 1965. Rooting characteristics of native grassland species in Saskatchewan. *Journal of Ecology* 53:475-507.
- DeLuca, T.H., and P. Lesica. 1996. Long-term harmful effects of crested wheatgrass on Great Plains grassland

ecosystems. *Journal of Soil and Water Conservation* 51:408-409.

Derner, J.D., and R.H. Hart. 2007. Grazing-induced modifications to peak standing crop in northern mixed-grass prairie. *Rangeland Ecology and Management* 60:270-276.

Dix, R.L. 1960. The effects of burning on the mulch structure and species composition of grasslands in western North Dakota. *Ecology* 41:49-56.

Dormaer, J.F., and S. Smoliak. 1985. Recovery of vegetative cover and soil organic matter during revegetation of abandoned farmland in a semiarid climate. *Journal of Range Management* 38:487-491.

Dormaer, J.F., and W.D. Willms. 1990. Effect of grazing and cultivation on some chemical properties of soils in the mixed prairie. *Journal of Range Management* 43:456-460.

Dormaer, J.F., B.W. Adams, and W.D. Willms. 1994. Effect of grazing and abandoned cultivation on a *Stipa-Bouteloua* community. *Journal of Range Management* 47:28-32.

Dormaer, J.F., M.A. Naeth, W.D. Willms, and D.S. Chanasyk. 1995. Effect of native prairie, crested wheatgrass (*Agropyron cristatum*) and Russian wildrye (*Elymus junceus*) on soil chemical properties. *Journal of Range Management* 48:258-263.

Federal Geographic Data Committee. 2008. The National Vegetation Classification Standard, Version 2. FGDC Vegetation Subcommittee. FGDC-STD-005-2008 (Version 2). pp. 126.

Haferkamp, M.R., R.K. Heitschmidt, and M.G. Karl. 1997. Influence of Japanese brome on western wheatgrass yield. *Journal of Range Management* 50:44-50.

Harmony, K.R. 2007. Grazing and burning Japanese brome (*Bromus japonicus*) on mixed grass rangelands. *Rangeland Ecology and Management* 60:479-486.

Hart, M., S.S. Waller, S.R. Lowry, and R.N. Gates. 1985. Disking and seeding effects on sod bound mixed prairie. *Journal of Range Management* 38:121-125.

Heidinga, L., and S.D. Wilson. 2002. The impact of an invading alien grass (*Agropyron cristatum*) on species turnover in native prairie. *Diversity and Distributions* 8:249-258.

Henderson, D.C., and M.A. Naeth. 2005. Multi-scale impacts of crested wheatgrass invasion in mixed-grass prairie. *Biological Invasions* 7:639-650.

Herrick, J.E., J.W. Van Zee, K.M. Havstad, L.M. Burkett, and W.G. Whitford. 2009. Monitoring manual for grassland, shrubland and savanna ecosystems. U.S. Department of Agriculture, Agricultural Research Service, Jornada Experimental Range, Las Cruces, NM.

Higgins, K.F. 1986. Interpretation and compendium of historical fire accounts in the Northern Great Plains. U.S. Fish and Wildlife Service Resource Publication 161.

Howard, J. L. 1999. *Artemisia tridentata* subsp. *wyomingensis*. In: Fire Effects Information System, U.S. Department of Agriculture, Forest Service <http://www.fs.fed.us/database/feis/plants/shrub/arttriv/all.html> (accessed 8/11/2016).

Interagency Ecological Site Handbook for Rangelands. USDA Natural Resources Conservation Service, USDA Forest Service, USDI Bureau of Land Management. January 2013.

Joern, A. 2005. Disturbance by fire frequency and bison grazing modulate grasshopper assemblages in tallgrass prairie. *Ecology* 86:861-873.

Lacey, J., R. Carlstrom, and K. Williams. 1995. Chiseling rangeland in Montana. *Rangelands* 17:164-166.

Land Resource Regions and Major Land Resource Areas of the United States, the Caribbean, and the Pacific

Basin. USDA Handbook 296. USDA Natural Resources Conservation Service. 2006.

Laycock, W.A. 1988. History of grassland plowing and grass planting on the Great Plains. In: J.E. Mitchell (ed.) Impacts of the Conservation Reserve Program in the Great Plains—Symposium Proceedings, September 16-18, 1987. USDA Forest Service, Rocky Mountain Forest and Range Experiment Station, General Technical Report RM-158.

Laycock, W.A. 1991. Stable states and thresholds of range condition on North American rangelands. *Journal of Range Management* 44:427-433.

Lockwood, J.A. 2004. *Locust: The devastating rise and mysterious disappearance of the insect that shaped the American frontier*. Basic Books, New York, NY.

McNab, W.H., et al. 2007. Description of ecological subregions: Sections of the conterminous United States [CD-ROM]. USDA Forest Service, General Technical Report WO-76B.

Montana State College. 1949. Similar vegetative rangeland types in Montana. Montana State College, Agricultural Experiment Station.

National Ecological Site Handbook. USDA Natural Resources Conservation Service. March 2017.

National Range and Pasture Handbook. USDA Natural Resources Conservation Service. December 2003.

National Soil Information System. USDA Natural Resources Conservation Service.  
[https://www.nrcs.usda.gov/wps/portal/nrcs/detail/soils/survey/geo/?cid=nrcs142p2\\_053552](https://www.nrcs.usda.gov/wps/portal/nrcs/detail/soils/survey/geo/?cid=nrcs142p2_053552).

National Soil Survey Handbook. USDA Natural Resources Conservation Service. November 2019.

Nesser, J.A., G.L. Ford, C.L. Maynard, and D.S. Page-Dumroese. 1997. Ecological units of the Northern Region: Subsections. USDA Forest Service, Intermountain Research Station, General Technical Report INT-GTR-369.

NRCS Plants Database. USDA Natural Resources Conservation Service. <https://plants.usda.gov/java/>.

Oard, M.J. 1993. A method of predicting chinook winds east of the Montana Rockies. *Weather and Forecasting* 8:166-180.

Ogle, S.M., W.A. Reiners, and K.G. Gerow. 2003. Impacts of exotic annual brome grasses (*Bromus* spp.) on ecosystem properties of the northern mixed grass prairie. *American Midland Naturalist* 149:46-58.

Rowe, J.S. 1969. Lightning fires in Saskatchewan grassland. *Canadian Field Naturalist* 83:317-327.

Salo, E.D., et al. 2004. Grazing intensity effects on vegetation, livestock and non-game birds in North Dakota mixed-grass prairie. Proceedings of the 19th North American Prairie Conference, Madison, WI.

Samuel, M.J., and R.H. Hart. 1994. Sixty-one years of secondary succession on rangelands of the Wyoming High Plains. *Journal of Range Management* 47:184-191.

Shay, J., D. Kunec, and B. Dyck. 2001. Short-term effects of fire frequency on vegetation composition and biomass in mixed prairie in south-western Manitoba. *Plant Ecology* 155:157-167.

Smith, B., and G.J. McDermid. 2014. Examination of fire-related succession within the dry mixed-grass subregion of Alberta with the use of MODIS and Landsat. *Rangeland Ecology and Management* 67:307-317.

Smith, R.E. 2013. Conserving Montana's sagebrush highway: Long distance migration in sage-grouse. M.S. thesis, University of Montana, Missoula, MT.

Smoliak, S., J.F. Dormaar, and A. Johnston. 1972. Long-term grazing effects on *Stipa-Bouteloua* prairie soils. *Journal of Range Management* 25:246-250.

Soil Survey Manual. USDA Natural Resources Conservation Service. March 2017.

Soil Survey Staff. 2014. Keys to soil taxonomy, 12th edition. USDA Natural Resources Conservation Service.

Toledo, D., M. Sanderson, K. Spaeth, J. Hendrickson, and J. Printz. 2014. Extent of Kentucky bluegrass and its effect on native plant species diversity and ecosystem services in the Northern Great Plains of the United States. *Invasive Plant Science and Management* 7:543-552.

Umbanhowar, Jr., C.E. 2004. Interactions of climate and fire at two sites in the Northern Great Plains. *Palaeogeography, Palaeoclimatology, and Palaeoecology* 208:141-152.

U.S. Department of Agriculture, Natural Resources Conservation Service. Glossary of landform and geologic terms. National Soil Survey Handbook, Title 430-VI, Part 629.02c. [http://www.nrcs.usda.gov/wps/portal/nrcs/detail/soils/ref/?cid=nrcs142p2\\_054242](http://www.nrcs.usda.gov/wps/portal/nrcs/detail/soils/ref/?cid=nrcs142p2_054242) (accessed 13 April 2016).

U.S. Fish and Wildlife Service. 2013. Greater sage-grouse (*Centrocercus urophasianus*) conservation objectives: Final report.

Vermeire, L.T., J.L. Crowder, and D.B. Wester. 2011. Plant community and soil environment response to summer fire in the northern Great Plains. *Rangeland Ecology and Management* 64:37-46.

Vermeire, L.T., J.L. Crowder, and D.B. Wester. 2014. Semiarid rangeland is resilient to summer fire and postfire grazing utilization. *Rangeland Ecology and Management* 67:52-60.

Vuke, S.M., K.W. Porter, J.D. Lonn, and D.A. Lopez. 2007. Geologic map of Montana - information booklet: Montana Bureau of Mines and Geology Geologic Map 62-D.

Wambolt, C.L., K.S. Walhof, and M.R. Frisina. 2001. Recovery of big sagebrush communities after burning in southwestern Montana. *Journal of Environmental Management*. 61:243-252.

Watts, M.J., and C.L. Wambolt. 1996. Long-term recovery of Wyoming big sagebrush after four treatments. *Journal of Environmental Management* 46:95-102.

Whisenant, S.G. 1990. Postfire population dynamics of *Bromus japonicus*. *American Midland Naturalist* 123:301-308.

Wilson, S.D., and J.M. Shay. 1990. Competition, fire, and nutrients in a mixed-grass prairie. *Ecology* 71:1959-1967.

## **Contributors**

Jeff Fenton  
Scott Brady  
Maryjo Kimble  
Brian Kloster

## **Approval**

Kirt Walstad, 8/29/2024

## **Rangeland health reference sheet**

Interpreting Indicators of Rangeland Health is a qualitative assessment protocol used to determine ecosystem condition based on benchmark characteristics described in the Reference Sheet. A suite of 17 (or more) indicators are typically considered in an assessment. The ecological site(s) representative of an assessment location must be known prior to applying the protocol and must be verified based on soils and climate. Current plant community cannot be used to identify the ecological site.

Author(s)/participant(s)	
Contact for lead author	
Date	11/21/2024
Approved by	Kirt Walstad
Approval date	
Composition (Indicators 10 and 12) based on	Annual Production

## Indicators

1. **Number and extent of rills:**

---

2. **Presence of water flow patterns:**

---

3. **Number and height of erosional pedestals or terracettes:**

---

4. **Bare ground from Ecological Site Description or other studies (rock, litter, lichen, moss, plant canopy are not bare ground):**

---

5. **Number of gullies and erosion associated with gullies:**

---

6. **Extent of wind scoured, blowouts and/or depositional areas:**

---

7. **Amount of litter movement (describe size and distance expected to travel):**

---

8. **Soil surface (top few mm) resistance to erosion (stability values are averages - most sites will show a range of values):**

---

9. **Soil surface structure and SOM content (include type of structure and A-horizon color and thickness):**

---

10. **Effect of community phase composition (relative proportion of different functional groups) and spatial distribution on infiltration and runoff:**

---

11. **Presence and thickness of compaction layer (usually none; describe soil profile features which may be mistaken for compaction on this site):**

---



12. **Functional/Structural Groups (list in order of descending dominance by above-ground annual-production or live foliar cover using symbols: >>, >, = to indicate much greater than, greater than, and equal to):**

Dominant:

Sub-dominant:

Other:

Additional:

---

13. **Amount of plant mortality and decadence (include which functional groups are expected to show mortality or decadence):**
- 

14. **Average percent litter cover (%) and depth ( in):**
- 

15. **Expected annual annual-production (this is TOTAL above-ground annual-production, not just forage annual-production):**
- 

16. **Potential invasive (including noxious) species (native and non-native). List species which BOTH characterize degraded states and have the potential to become a dominant or co-dominant species on the ecological site if their future establishment and growth is not actively controlled by management interventions. Species that become dominant for only one to several years (e.g., short-term response to drought or wildfire) are not invasive plants. Note that unlike other indicators, we are describing what is NOT expected in the reference state for the ecological site:**
- 

17. **Perennial plant reproductive capability:**
-