

Ecological site R058BY222WY Loamy (Ly) 15-17" PZ

Last updated: 10/04/2023
Accessed: 05/01/2024

General information

Provisional. A provisional ecological site description has undergone quality control and quality assurance review. It contains a working state and transition model and enough information to identify the ecological site.

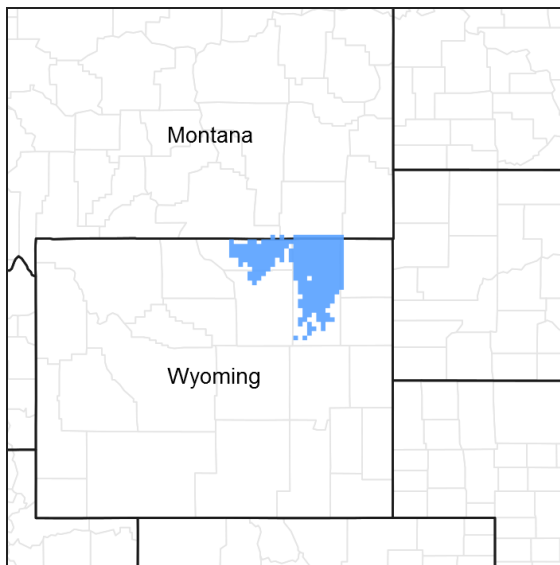

Figure 1. Mapped extent

Areas shown in blue indicate the maximum mapped extent of this ecological site. Other ecological sites likely occur within the highlighted areas. It is also possible for this ecological site to occur outside of highlighted areas if detailed soil survey has not been completed or recently updated.

MLRA notes

Major Land Resource Area (MLRA): 058B–Northern Rolling High Plains, Southern Part

MLRA 58B is located in northeastern Wyoming (95 percent) and extreme southeastern Montana (5 percent). It is comprised of sedimentary plains, scoria hills, and river valleys. The major rivers include the Powder, Tongue, Belle Fourche, Cheyenne, and North Platte. Tributaries include the Little Powder River, Little Missouri River, Clear Creek, Crazy Woman Creek, and others. This MLRA is traversed by Interstates 25 and 90, and U.S. Highways 14 and 16. The extent of MLRA 58B covers approximately 12.3 million acres. Major land uses include rangeland (approximately 93 percent), cropland, pasture, and hayland (approximately 2 percent), and forest, urban, and miscellaneous uses (approximately 5 percent). Cities include Buffalo, Casper, Sheridan, and Gillette, WY. Land ownership is mostly private. Federal lands include the Thunder Basin National Grassland (U.S. Forest Service) and lands administered by the Bureau of Land Management. Areas of interest in MLRA 58B in Wyoming include Fort Phil Kearny State Historic Site, Glendo State Park, and Lake DeSmet. The elevations in MLRA 58B increase gradually from north to south and range from approximately 2,900 to 5,900 feet. A few buttes are higher than 6,800 feet. The average annual precipitation in this area ranges from 10 to 17 inches per year. Precipitation occurs mostly during the growing season, often during rapidly developing thunderstorms. Mean annual air temperature is 46 degrees Fahrenheit. Summer temperatures may exceed 100 degrees Fahrenheit. Winter temperatures may drop to below zero. Snowfall averages 45 inches per year, but varies from 25 to over 70 inches in some locales.

Classification relationships

USDA Natural Resources Conservation Service (NRCS):

Land Resource Region – G Western Great Plains Range and Irrigation; Major Land Resource Area (MLRA) – 58B Northern Rolling High Plains, Southern Part (USDA, 2006)

Relationship to Other Classifications:

USDA Forest Service (FS) Classification Hierarchy:

Province – 331 Great Plains-Palouse Dry Steppe; Section – 331G-Powder River Basin; Subsections – 331Gb Montana Shale Plains, 331Ge Powder River Basin, 331Gf South Powder River Basin-Scoria Hills (Cleland et al, 1997)

Environmental Protection Agency (EPA) Classification Hierarchy:

Level III Ecoregion – 43 Northwestern Great Plains; Level IV Ecoregion – 43p Scoria Hills, 43q Mesic-Dissected Plains, 43w Powder River Basin (EPA, 2013)

<https://www.epa.gov/eco-research/ecoregions>

Ecological site concept

This ecological site occurs on nearly level to gently sloping sedimentary plains, hills, terraces, and fans at elevations ranging from 2,900 to 5,900 feet. Slopes range from 0 to 15 percent but are generally less than 8 percent. This site occurs on all aspects, although aspect is not a significant factor. The soils of this ecological site are moderately deep to very deep and are well drained. The soil surface textures are typically loam, very fine sandy loam, fine sandy loam, or silt loam.

Associated sites

R058BY204WY	Clayey (Cy) 15-17" PZ The Clayey 15-17 ecological site occurs on slopes ranging from 0 to 15 percent and has soils with 35 percent or greater clay content. The Clayey 15-17 ecological site is located on similar landform positions as the the Loamy 15-17 ecological site.
R058BY128WY	Lowland (LL) 10-14" PZ The Lowland 15-17 ecological site occurs on slopes ranging from 0 to 6 percent, has a soil depth of 80 inches, and has higher total annual production. The Lowland 15-17 ecological site is positioned below the Loamy 15-17 ecological site.
R058BY250WY	Sandy (Sy) 15-17" PZ The Sandy 15-17 ecological site occurs on slopes ranging from 0 to 15 percent, has a soil depth of 20 to 80 inches, and has higher total annual production. The Sandy 15-17 ecological site is generally positioned above the Loamy 15-17 ecological site.
R058BY262WY	Shallow Loamy (SwLy) 15-17" PZ The Shallow Loamy 15-17 ecological site occurs on slopes ranging from 0 to 60 percent, has a soil depth of 10 to 20 inches, and has lower total annual production. The Shallow Loamy 15-17 ecological site is positioned above the Loamy 15-17 ecological site.

Similar sites

R058BY204WY	Clayey (Cy) 15-17" PZ The Clayey 15-17 ecological site occurs on slopes ranging from 0 to 15 percent and has soils with 35 percent or greater clay content. The Clayey 15-17 ecological site is located on similar landform positions as the the Loamy 15-17 ecological site.
-------------	---

Table 1. Dominant plant species

Tree	Not specified
------	---------------

Shrub	(1) <i>Artemisia tridentata</i>
Herbaceous	(1) <i>Pascopyrum smithii</i> (2) <i>Hesperostipa comata</i>

Physiographic features

This ecological site occurs on nearly level to gently sloping fans, ridges, and on footslopes or backslopes of hills, on sedimentary plains or uplands. Elevations range from 2,900 to 5,900 feet. Slopes range from 0 to 15 percent, but are generally less than 8 percent. This ecological site occurs on all aspects. Aspect is not a significant factor.

Table 2. Representative physiographic features

Landforms	(1) Alluvial fan (2) Fan remnant (3) Ridge (4) Hill
Runoff class	Low to high
Flooding frequency	None
Ponding frequency	None
Elevation	884–1,798 m
Slope	0–15%
Ponding depth	0 cm
Water table depth	203 cm
Aspect	Aspect is not a significant factor

Climatic features

The average annual precipitation ranges from 10 to 17 inches per year across MLRA 58B. There are two Precipitation Zones (PZ). The 10 to 14 inch precipitation zone is predominant across the MLRA, including portions of Sheridan, Johnson, and Natrona Counties; portions of Campbell and Converse Counties; and smaller portions of Weston and Niobrara Counties. The 15 to 17 inch precipitation zone occurs in northern and eastern portions of the MLRA, including portions of Sheridan, Campbell, and western Crook Counties. Wide fluctuations in precipitation may occur from year to year, and occasional periods of extended drought (longer than one year in duration) can be expected. Two-thirds of the annual precipitation occurs during the growing season from May through September. Mean Annual Air Temperature (MAAT) is 46 degrees Fahrenheit. Cold air outbreaks from Canada in winter move rapidly from northwest to southeast and account for extreme minimum temperatures. Chinook winds may also occur in winter and bring rapid rises in temperature. Extreme storms may occur during the winter, but most severely affect ranching operations during late winter and spring. High-intensity afternoon thunderstorms may occur during the summer. Annual wind speeds average about 5 mph. Daytime winds are generally stronger than nighttime winds. Occasional strong storms may bring brief periods of high winds with gusts of more than 75 mph. The average length of the freeze-free period (28 degrees Fahrenheit) is 125 days and generally occurs from May 16 to September 19. The average frost-free period (32 degrees Fahrenheit) is 101 days and generally occurs from June 1 to September 9.

The growth of native cool-season plants begins in late April to early May with peak growth occurring in mid to late June. Native warm-season plants begin growth in late May to early June and continue into August. Regrowth of cool-season plants occurs in September in most years, depending upon moisture.

Note: The climate described here is based on historic climate station data and is averaged to provide an overview of the annual precipitation, temperatures, and growing season. Future climate is beyond the scope of this document. However, research to determine the effects of elevated CO₂ and/or heating on mixed-grass prairie ecosystems, and how it may relate to future plant communities, is ongoing.

For detailed information, or to find a specific climate station, visit the Western Regional Climate Center (WRCC) website: Western Regional Climate Center, Historical Data, Western U.S. Climate summaries, NOAA Coop

Stations, Wyoming (Note: Montana climate stations are also listed under the Wyoming link).
<https://wrcc.dri.edu/summary/Climismwy.html>

Wind speed averages can be found at the WRCC home page, under the Specialty Climate tab: <https://wrcc.dri.edu/>

The following tables represent area-wide climate data for the 15 to 17 inch precipitation zone:

Table 3. Representative climatic features

Frost-free period (characteristic range)	88-105 days
Freeze-free period (characteristic range)	122-130 days
Precipitation total (characteristic range)	381-406 mm
Frost-free period (actual range)	83-109 days
Freeze-free period (actual range)	119-130 days
Precipitation total (actual range)	381-432 mm
Frost-free period (average)	101 days
Freeze-free period (average)	125 days
Precipitation total (average)	381 mm

Climate stations used

- (1) DOUGLAS 1 SE [USC00482685], Douglas, WY
- (2) BIDDLE 8 SW [USC00240743], Biddle, MT
- (3) DILLINGER [USC00482580], Gillette, WY
- (4) GILLETTE 4SE [USC00483855], Gillette, WY
- (5) LEITER 9N [USC00485506], Clearmont, WY
- (6) SHERIDAN CO AP [USW00024029], Sheridan, WY

Influencing water features

This upland ecological site is not influenced by a water table or run in from adjacent sites. Due to the semi-arid climate in which it occurs, the water budget is normally contained within the soil pedon. Soil moisture is recharged by spring rains, but it rarely exceeds field capacity in the upper 40 inches before being depleted by evapotranspiration. During intense precipitation events, precipitation rates frequently exceed infiltration rates and the site delivers moisture to downslope sites through surface runoff. Moisture loss through evapotranspiration exceeds precipitation for a majority of the growing season. Soil moisture is the primary limiting factor for vegetative production on this ecological site.

Wetland description

N/A

Soil features

The soils on this ecological site are moderately deep to very deep, well drained, and formed from alluvium or eolian deposits or residuum derived from sandstone, shale, and siltstone. The depth to a soil restrictive layer is greater than 20 inches from the soil surface. The surface layer ranges from a depth of 1 to 7 inches in thickness. The soil surface horizon textures are typically loam, very fine sandy loam, or fine sandy loam, but may include clay loam and silt loam and contain less than 35 percent clay. The subsoil horizons are typically loam, clay loam, or sandy clay loam, but may include very fine sandy loam or silt loam. Soils on this ecological site are typically leached of carbonates at 6 to 40 inches or greater. Few soils have carbonates within 6 inches of the soil surface. The soil moisture regime is typically ustic aridic and the soil temperature regime is mesic.

Major soil series correlated to this ecological site include the Deekay, Oldwolf, Iwait, Jaywest, Spottedhorse,

Ucross, and Ziggy series.

The attributes listed below represent 0 to 40 inches in depth or to the first restrictive layer.

Table 4. Representative soil features

Parent material	(1) Alluvium–shale (2) Eolian deposits–sandstone (3) Residuum–sandstone (4) Residuum–shale (5) Residuum–siltstone
Surface texture	(1) Loam (2) Silt loam (3) Very fine sandy loam
Drainage class	Well drained
Permeability class	Moderate to moderately rapid
Depth to restrictive layer	51–203 cm
Soil depth	51–203 cm
Surface fragment cover ≤3"	0–5%
Surface fragment cover >3"	0%
Available water capacity (0-101.6cm)	10.16–21.34 cm
Calcium carbonate equivalent (0-101.6cm)	0–10%
Clay content (0-101.6cm)	0%
Electrical conductivity (0-101.6cm)	0–4 mmhos/cm
Sodium adsorption ratio (0-101.6cm)	0–5
Soil reaction (1:1 water) (0-101.6cm)	6.6–8.4
Subsurface fragment volume ≤3" (0-101.6cm)	0–35%
Subsurface fragment volume >3" (0-101.6cm)	0–10%

Table 5. Representative soil features (actual values)

Drainage class	Not specified
Permeability class	Moderately slow to moderately rapid
Depth to restrictive layer	Not specified
Soil depth	Not specified
Surface fragment cover ≤3"	Not specified
Surface fragment cover >3"	Not specified
Available water capacity (0-101.6cm)	Not specified
Calcium carbonate equivalent (0-101.6cm)	Not specified
Clay content (0-101.6cm)	Not specified

Electrical conductivity (0-101.6cm)	Not specified
Sodium adsorption ratio (0-101.6cm)	Not specified
Soil reaction (1:1 water) (0-101.6cm)	Not specified
Subsurface fragment volume <=3" (0-101.6cm)	Not specified
Subsurface fragment volume >3" (0-101.6cm)	Not specified

Ecological dynamics

The Reference State is the plant community in which interpretations are primarily based and is used as a reference in order to understand the original potential of the site. The Reference State evolved under the combined influences of climatic conditions, periodic fire activity, grazing by large herbivores, and impacts from small mammals and insects. Changes may occur to the Reference State due to management actions such as improper grazing management, climatic conditions such as drought, and natural events such as multiple fires in close succession. The reference plant community for this ecological site is dominated by a diversity of tall and medium height, cool-season and warm-season grasses which are tightly intermixed and well distributed over the site. Various forbs, half-shrubs, and shrubs are common on this site. The Reference Plant Community is not necessarily the management goal, as other vegetative states may be considered desired plant communities as long as critical resource concerns are met.

In addition to the Reference State, other plant communities can occur on this site and are usually the result of historic management practices. Long term overgrazing on this ecological site results in a decrease of tallgrasses, mid-grasses, and more palatable forbs and in an increase of shortgrasses, sedges, and less palatable forbs. Half-shrubs and shrubs increase in the absence of prescribed fire and wildfire. More frequent fire intervals decreases the shrub component resulting in a site dominated by herbaceous species. There are various transitional stages which may occur on this ecological site. The information presented is representative of a dynamic set of plant communities that illustrate the complex interaction of several ecological processes.

State and transition model

Ecosystem states

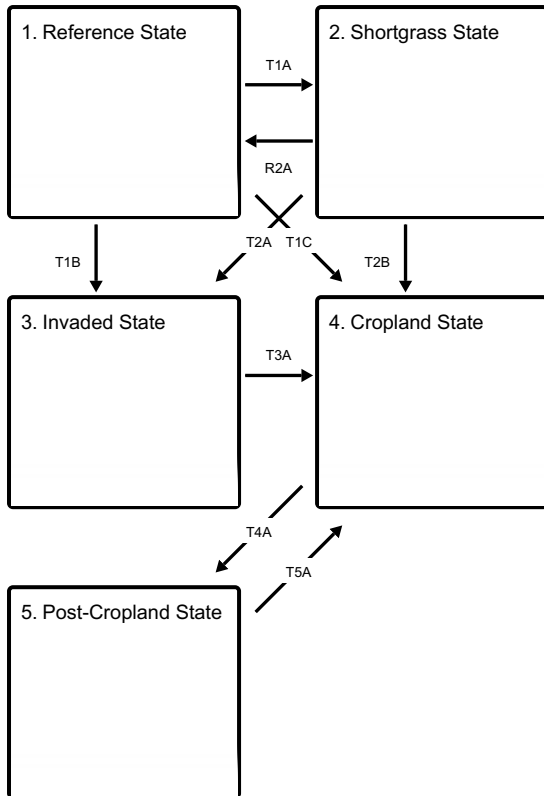

T1A - Prolonged drought, improper grazing, or a combination of these factors

T1B - Introduction of non-native invasive species (annual bromes, crested wheatgrass, noxious weeds)

T1C - Conversion to cropland

R2A - Proper grazing management in combination with rangeland seeding, grazing land mechanical treatment, and timely moisture (management intensive and costly)

T2A - Introduction of non-native invasive species (annual bromes, crested wheatgrass, noxious weeds)

T2B - Conversion to cropland

T3A - Conversion to cropland

T4A - Cessation of annual cropping

T5A - Conversion to cropland

State 1 submodel, plant communities

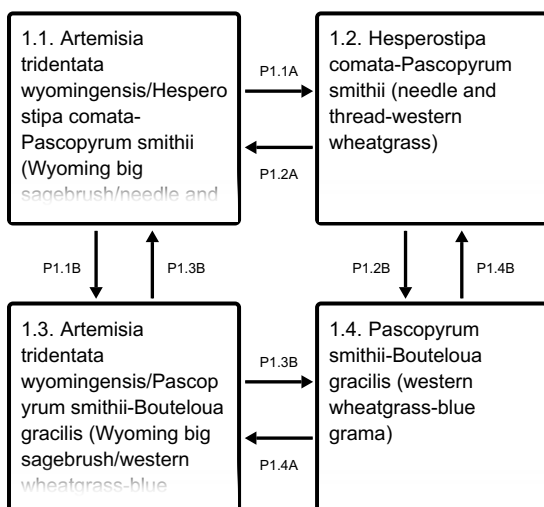

P1.1A - Prescribed fire and wildfire, mechanical and chemical treatments, and biological processes

P1.1B - Drought, improper grazing management

P1.2A - Approximately 30 years post-fire regrowth

P1.2B - Drought, improper grazing management, multiple fires in close succession

P1.3B - Normal or above average precipitation, proper grazing management

P1.3B - Prescribed fire and wildfire, mechanical and chemical treatments, and biological processes

P1.4B - Normal or above average precipitation, proper grazing management

P1.4A - Approximately 30 years post-fire regrowth

State 2 submodel, plant communities

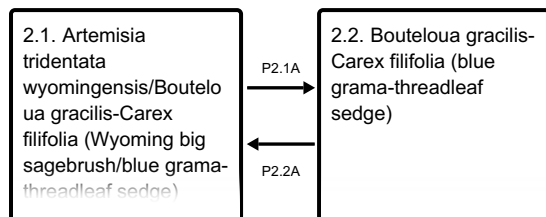

P2.1A - Prescribed fire and wildfire, mechanical and chemical treatments, and biological processes

P2.2A - Approximately 30 years post-fire regrowth

State 3 submodel, plant communities

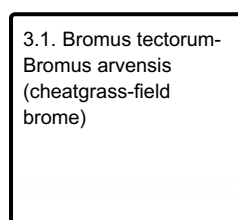

State 4 submodel, plant communities

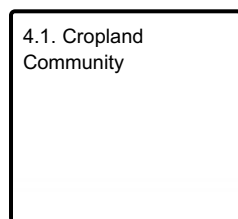

State 5 submodel, plant communities

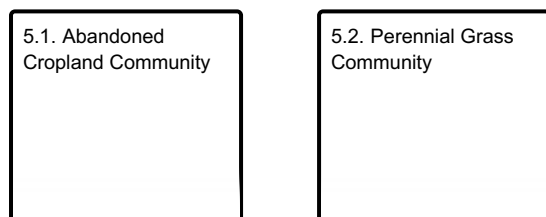

State 1 Reference State

The Reference State (1) for this ecological site evolved under the combined influences of climatic conditions, periodic fire activity, grazing by large herbivores, and impacts from small mammals and insects. The Reference State (1) is the plant community in which interpretations are primarily based and is used as a reference in order to understand the original potential of the site. The Reference State (1) for this ecological site consists of 4 community phases.

Community 1.1

Artemisia tridentata wyomingensis/Hesperostipa comata-Pascopyrum smithii (Wyoming big sagebrush/needle and thread-western wheatgrass)

Community Phase 1.1 is characterized by a mixed-grass community and Wyoming big sagebrush. The predominant species are cool-season grasses such as needle and thread, western wheatgrass, thickspike wheatgrass, and green needlegrass. Warm-season bunchgrasses such as big bluestem are also present.

Shortgrasses and sedges such as blue grama, Cusick's bluegrass, prairie junegrass, Sandberg bluegrass, prairie junegrass, threadleaf sedge, and needleleaf sedge are present at low cover. Forbs such as western yarrow, stemless mock goldenweed, rosy pussytoes, tapertip hawksbeard, purple prairie clover, white prairie clover, sulphur flower buckwheat, American vetch, upright prairie coneflower, and large Indian breadroot are present. The dominant shrub species in Wyoming big sagebrush and the more common sub-shrub is winterfat. The potential vegetation is approximately 74 percent grasses, 10 percent forbs, and 16 percent shrubs. The total annual production (air-dry weight) is approximately 1,900 pounds per acre during an average year, but can range from approximately 1,500 pounds per acre in below average years to approximately 2,300 pounds per acres in above average years.

Table 6. Annual production by plant type

Plant Type	Low (Kg/Hectare)	Representative Value (Kg/Hectare)	High (Kg/Hectare)
Grass/Grasslike	1244	1576	1908
Shrub/Vine	269	341	412
Forb	168	213	258
Total	1681	2130	2578

Figure 9. Plant community growth curve (percent production by month). WY1401, 10-14NP upland sites.

Jan	Feb	Mar	Apr	May	Jun	Jul	Aug	Sep	Oct	Nov	Dec
0	0	0	10	30	35	10	5	5	5	0	0

Community 1.2

Hesperostipa comata-Pascopyrum smithii (needle and thread-western wheatgrass)

Community Phase 1.2 is characterized by a reduction of Wyoming big sagebrush and an increase in cool-season, rhizomatous wheatgrasses and mid to tall-statured bunchgrasses such as western wheatgrass, needle and thread, green needlegrass, and big bluestem. Shortgrasses and sedges such as blue grama, prairie junegrass, Cusick's bluegrass, Sandberg bluegrass, threadleaf sedge, and needleleaf sedge occur at low cover. Forbs such as western yarrow, stemless mock goldenweed, rosy pussytoes, tapertip hawksbeard, purple prairie clover, white prairie clover, sulphur flower buckwheat, American vetch, upright prairie coneflower, and large Indian breadroot are common. Wyoming big sagebrush is rare to absent. This community occurs following sagebrush mortality due to wildfire, prescribed fire, mechanical and chemical treatments, or biological processes and may persist for 30 years or more thereafter (Watts and Wambolt, 1996; Wambolt et. al., 2001).

Community 1.3

Artemisia tridentata wyomingensis/Pascopyrum smithii-Bouteloua gracilis (Wyoming big sagebrush/western wheatgrass-blue grama)

Community Phase 1.3 is characterized by an increase in shortgrass species and sedges such as blue grama, prairie junegrass, Cusick's bluegrass, Sandberg bluegrass, threadleaf sedge, and needleleaf sedge and a decrease in cool-season, mid to tall-statured grasses such as western wheatgrass, needle and thread, green needlegrass, and big bluestem. Mid to tall-statured grasses contribute less to overall production. This plant community occurs when site conditions decline due to long-term drought, improper grazing management such as continuous season-long or year-long grazing, or a combination of these factors.

Community 1.4

Pascopyrum smithii-Bouteloua gracilis (western wheatgrass-blue grama)

Community Phase 1.4 is characterized by an increase in shortgrass species and sedges such as blue grama, prairie junegrass, Cusick's bluegrass, Sandberg bluegrass, threadleaf sedge, and needleleaf sedge and a decrease in cool-season, mid to tall-statured grasses such as western wheatgrass, needle and thread, green needlegrass, and big bluestem. Wyoming big sagebrush is rare to absent. This plant community occurs when site conditions decline due to long-term drought or improper grazing management such as continuous season-long or year-long grazing, or a combination of these factors. Sagebrush mortality is evident due to wildfire, prescribed fire,

mechanical and chemical treatments, or biological processes.

Pathway P1.1A **Community 1.1 to 1.2**

Community Phase 1.1 will transition to Community Phase 1.2 through prescribed fire and wildfire, mechanical and chemical treatments, and biological processes. Wyoming big sagebrush is greatly reduced and perennial grasses will dominate the site.

Pathway P1.1B **Community 1.1 to 1.3**

Drought, improper grazing management such as continuous season-long or year-long grazing, or a combination of these factors can shift Community Phase 1.1 to Community Phase 1.3. These factors favor an increase in blue grama and a decrease in cool-season mid-statured grasses (Coupland, 1961; Shay et al., 2001). Wyoming big sagebrush cover will be similar to Community Phase 1.1.

Pathway P1.2A **Community 1.2 to 1.1**

Approximately 30 years or more of natural vegetative regrowth will shift Community Phase 1.2 to Community Phase 1.1. Approximately 30 years or more without major mortality permits Wyoming big sagebrush to recolonize the site.

Pathway P1.2B **Community 1.2 to 1.4**

Drought, improper grazing practices such as continuous season-long or year-long grazing, multiple fires in close succession, or a combination of these factors can shift Community Phase 1.2 to Community Phase 1.3. These factors favor an increase in blue grama and a decrease in cool-season mid-statured grasses (Coupland, 1961; Shay et al., 2001). Wyoming big sagebrush cover will be similar to Community Phase 1.2.

Pathway P1.3B **Community 1.3 to 1.1**

Approximately 30 years or more following mortality; normal or above-average precipitation and proper grazing management shifts Community Phase 1.3 to Community Phase 1.1.

Pathway P1.3B **Community 1.3 to 1.4**

Community Phase 1.3 will transition to Community Phase 1.4 through prescribed fire and wildfire, mechanical and chemical treatments, and biological processes. Wyoming big sagebrush is greatly reduced and perennial grasses will dominate the site.

Pathway P1.4B **Community 1.4 to 1.2**

Less than approximately 30 years following mortality; normal or above-average precipitation and proper grazing management shifts Community Phase 1.4 to Community Phase 1.2.

Pathway P1.4A **Community 1.4 to 1.3**

Approximately 30 years or more of natural vegetative regrowth will shift Community Phase 1.4 to Community Phase 1.3. Approximately 30 years or more without fire or similar mortality permits Wyoming big sagebrush to recolonize the site.

State 2

Shortgrass State

The dynamics of the Shortgrass State (2) are driven by long-term drought, improper grazing management such as continuous season-long or year-long grazing, or a combination of these factors. The Shortgrass State (2) for this ecological site consists of 2 community phases.

Community 2.1

***Artemisia tridentata wyomingensis/Bouteloua gracilis-Carex filifolia* (Wyoming big sagebrush/blue grama-threadleaf sedge)**

Community Phase 2.1 is characterized by a dominance of shortgrasses and sedges such as blue grama, Cusick's bluegrass, prairie junegrass, Sandberg bluegrass, prairie junegrass, threadleaf sedge, and needleleaf sedge. Cool-season, mid to tall-statured grasses such as western wheatgrass, needle and thread, green needlegrass, and big bluestem are rare or absent. Prairie sagewort, broom snakeweed, and Wyoming big sagebrush are common. This plant community occurs when site conditions decline due to long-term drought, improper grazing management such as continuous season-long or year-long grazing, or a combination of these factors. This community phase results in a reduction of soil surface litter, soil organic matter, and infiltration and an increase of soil surface runoff. This plant community is capable of tolerating season-long, heavy grazing and therefore is highly resistant to change.

Community 2.2

***Bouteloua gracilis-Carex filifolia* (blue grama-threadleaf sedge)**

Community Phase 2.2 is characterized by a complete dominance of shortgrasses and sedges such as blue grama, Cusick's bluegrass, prairie junegrass, Sandberg bluegrass, prairie junegrass, threadleaf sedge, and needleleaf sedge. Cool-season, mid to tall-statured grasses such as western wheatgrass, needle and thread, green needlegrass, and big bluestem are rare or absent. Prairie sagewort is common and Wyoming big sagebrush is rare or absent. This plant community occurs when site conditions decline due to long-term drought, improper grazing management such as continuous season-long or year-long grazing, or a combination of these factors, and a fire has occurred on the site less than approximately 30 years prior. Sagebrush mortality is evident due to wildfire, prescribed fire, mechanical and chemical treatments, or biological processes. This community phase results in a reduction of soil surface litter, soil organic matter, and infiltration and an increase of soil surface runoff. This plant community is capable of tolerating season-long, heavy grazing and therefore is highly resistant to change.

Pathway P2.1A

Community 2.1 to 2.2

Community Phase 2.1 will transition to Community Phase 2.2 through prescribed fire and wildfire, mechanical and chemical treatments, and biological processes. Wyoming big sagebrush is greatly reduced and perennial grasses will dominate the site.

Pathway P2.2A

Community 2.2 to 2.1

It is estimated that approximately 30 years or more of natural vegetative regrowth could transition Community Phase 2.2 to Community Phase 2.1. It is possible that this transition could occur over time, however, the processes are not fully understood at this time. Therefore, this pathway is considered hypothetical until further investigation can be completed.

State 3

Invaded State

The Invaded State (3) occurs when invasive plant species invade native plant communities and displace the native species. The Invaded State (3) for this ecological site consists of 1 community phase.

Community 3.1

***Bromus tectorum-Bromus arvensis* (cheatgrass-field brome)**

Observations suggest that native species diversity declines significantly when invasive or noxious species exceed approximately 30 percent of the plant community. Non-native, perennial, drought tolerant grasses such as crested wheatgrass, non-native, annual, invasive species such as cheatgrass and field brome, and noxious weed species can eventually dominate the seedbank of this site and displace native species. Reduced plant species diversity, simplified structural complexity, and altered ecological processes result in a state that is substantially departed from the Reference State (1). The dominance of annual, invasive grasses such as cheatgrass and field brome increases the fire cycle frequency.

State 4 Cropland State

The Cropland State (4) occurs when cultivation occurs to the land. The Cropland State (4) for this ecological site consists of 1 community phase.

Community 4.1 Cropland Community

The land is cultivated and converted to crop production. Annual, cool-season cereal grains such as spring wheat, winter wheat, and barley are common crops which replace native plant communities.

State 5 Post-Cropland State

The Post-Cropland State (5) occurs when cultivated cropland is abandoned and allowed to either re-vegetate naturally or is seeded back to perennial species for livestock grazing or wildlife use. This state can transition back to the Cropland State (4) if the site is returned to cultivation. No formal studies have been obtained regarding Wyoming big sagebrush recovery following cultivation and further investigation is needed to assess Wyoming big sagebrush recovery in the Post-Cropland State (5). The Post-Cropland State (5) for this ecological site has 2 community phases.

Community 5.1 Abandoned Cropland Community

In the absence of active management, the site can re-vegetate naturally and potentially return to a perennial grassland community over time. Shortly after cropland is abandoned, annual and biennial forbs and annual brome grasses invade the site. The site is highly susceptible to erosion due to the absence of perennial species. Eventually, these pioneering annual species are replaced by perennial forbs and perennial shortgrasses. Depending on the historical management of the site, mid-statured perennial grasses may also return; however, species composition will depend upon the seed bank. Invasion of the site by exotic species, such as crested wheatgrass and annual bromes, will depend upon the site's proximity to a seed source. Fifty or more years after cultivation, these sites may have species composition similar to phases in the Reference State (1). However, soil quality is consistently lower than conditions prior to cultivation and a shift to the Reference State (1) is unlikely within a reasonable timeframe (Dormaar, J.F., and S. Smoliak. 1985).

Community 5.2 Perennial Grass Community

When the site is seeded to perennial forage species this community phase can persist for several decades. Introduced perennial grasses, in particular, may form monocultures that persist for 60 years or more (Samuel, M.J., and R.H. Hart. 1994). A mixture of native species may also be seeded to provide species composition and structural complexity similar to that of the Reference State (1). However, soil quality conditions have been substantially altered and will not return to pre-cultivation conditions within a reasonable timeframe.

Transition T1A State 1 to 2

Prolonged drought, improper grazing management such as continuous season-long or year-long grazing, or a

combination of these factors weaken the resilience of the Reference State (1) and drive its transition to the Shortgrass State (2). The Reference State (1) transitions to the Shortgrass State (2) when mid to tall-statured graminoids become rare and shortgrasses and sedges such as blue grama, Cusick's bluegrass, prairie junegrass, Sandberg bluegrass, prairie junegrass, threadleaf sedge, and needleleaf sedge dominate the plant community.

Transition T1B **State 1 to 3**

The Reference State (1) transitions to the Invaded State (3) when non-native grasses or noxious weeds invade the plant community. Exotic plant species dominate the site in terms of cover and production and site resilience has been substantially reduced. In addition, other rangeland health attributes, such as reproductive capacity of native grasses and soil quality, have been substantially altered from the Reference State (1).

Transition T1C **State 1 to 4**

Tillage or application of herbicide followed by seeding of cultivated crops, such as winter wheat, spring wheat, and barley, transitions the Reference State (1) to the Cropland State (4).

Restoration pathway R2A **State 2 to 1**

Blue grama can resist displacement by other species. A reduction in livestock grazing pressure alone may not be sufficient to reduce the cover of blue grama in the Shortgrass State (3) and mechanical treatments may be necessary. Therefore, returning the Shortgrass State (2) to the Reference State (1) can require considerable cost, energy, and time.

Conservation practices

Prescribed Grazing

Transition T2A **State 2 to 3**

The Shortgrass State (2) transitions to the Invaded State (3) when non-native grasses, noxious weeds, and other invasive plants invade the Shortgrass State (2). Exotic plant species dominate the site in terms of cover and production. Site resilience has been substantially reduced.

Transition T2B **State 2 to 4**

Tillage or application of herbicide followed by seeding of cultivated crops, such as winter wheat, spring wheat, and barley, transitions the Shortgrass State (2) to the Cropland State (4).

Transition T3A **State 3 to 4**

The Invaded State (3) will transition to the Cropland State (4) when the site is placed under cultivation.

Transition T4A **State 4 to 5**

The transition from the Cropland State (4) to the Post-Cropland State (5) occurs with the cessation of cultivation. The site may also be seeded to perennial forage species, such as crested wheatgrass and alfalfa, or a mix of native species.

Transition T5A State 5 to 4

Tillage or application of herbicide followed by seeding of cultivated crops, such as winter wheat, spring wheat, and barley, transitions the Post-Cropland State (5) to the Cropland State (4).

Additional community tables

Table 7. Community 1.1 plant community composition

Group	Common Name	Symbol	Scientific Name	Annual Production (Kg/Hectare)	Foliar Cover (%)
Grass/Grasslike					
1	Cool-Season Rhizomatous Grasses			420–644	
	western wheatgrass	PASM	<i>Pascopyrum smithii</i>	420–644	15–25
	thickspike wheatgrass	ELLAL	<i>Elymus lanceolatus ssp. lanceolatus</i>	420–644	15–25
2	Cool-Season Bunchgrasses			757–1160	
	needle and thread	HECO26	<i>Hesperostipa comata</i>	336–516	15–20
	green needlegrass	NAVI4	<i>Nassella viridula</i>	252–387	10–15
	Cusick's bluegrass	POCU3	<i>Poa cusickii</i>	168–258	5–10
3	Warm-Season Bunchgrasses			168–258	
	big bluestem	ANGE	<i>Andropogon gerardii</i>	168–258	5–10
4	Warm-Season Shortgrasses			168–258	
	blue grama	BOGR2	<i>Bouteloua gracilis</i>	168–258	5–10
5	Miscellaneous Grasses			420–644	
	Grass, perennial	2GP	<i>Grass, perennial</i>	84–129	1–5
	Indian ricegrass	ACHY	<i>Achnatherum hymenoides</i>	84–129	1–5
	hairy grama	BOHI2	<i>Bouteloua hirsuta</i>	84–129	1–5
	needleleaf sedge	CADU6	<i>Carex duriuscula</i>	84–129	1–5
	threadleaf sedge	CAFI	<i>Carex filifolia</i>	84–129	1–5
	plains reedgrass	CAMO	<i>Calamagrostis montanensis</i>	84–129	1–5
	prairie Junegrass	KOMA	<i>Koeleria macrantha</i>	84–129	1–5
	Sandberg bluegrass	POSE	<i>Poa secunda</i>	84–129	1–5
	bluebunch wheatgrass	PSSP6	<i>Pseudoroegneria spicata</i>	84–129	1–5
	sideoats grama	BOCU	<i>Bouteloua curtipendula</i>	84–129	1–5
	little bluestem	SCSC	<i>Schizachyrium scoparium</i>	84–129	1–5
Forb					
6	Forbs			252–387	
	Forb, perennial	2FP	<i>Forb, perennial</i>	84–129	1–5
	western yarrow	ACMIO	<i>Achillea millefolium var. occidentalis</i>	84–129	1–5
	stemless mock goldenweed	STAC	<i>Stenotus acaulis</i>	84–129	1–5
	textile onion	ALTE	<i>Allium textile</i>	84–129	1–5
	rosy pussytoes	ANRO2	<i>Antennaria rosea</i>	84–129	1–5
	aster	ASTER	<i>Aster</i>	84–129	1–5
	milkvetch	ASTRA	<i>Astragalus</i>	84–129	1–5

	tapertip hawksbeard	CRAC2	<i>Crepis acuminata</i>	84–129	1–5
	purple prairie clover	DAPU5	<i>Dalea purpurea</i>	84–129	1–5
	white prairie clover	DACA7	<i>Dalea candida</i>	84–129	1–5
	sulphur-flower buckwheat	ERUM	<i>Eriogonum umbellatum</i>	84–129	1–5
	scarlet beeblossom	GACO5	<i>Gaura coccinea</i>	84–129	1–5
	American vetch	VIAM	<i>Vicia americana</i>	84–129	1–5
	upright prairie coneflower	RACO3	<i>Ratibida columnifera</i>	84–129	1–5
	desertparsley	LOMAT	<i>Lomatium</i>	84–129	1–5
	large Indian breadroot	PEES	<i>Pediomelum esculentum</i>	84–129	1–5
	bluebells	MERTE	<i>Mertensia</i>	84–129	1–5
Shrub/Vine					
7	Shrubs			420–644	
	Wyoming big sagebrush	ARTRW8	<i>Artemisia tridentata ssp. wyomingensis</i>	168–258	5–15
	winterfat	KRLA2	<i>Krascheninnikovia lanata</i>	84–129	1–5
	Shrub (>.5m)	2SHRUB	<i>Shrub (>.5m)</i>	84–129	1–5
	Subshrub (<.5m)	2SUBS	<i>Subshrub (<.5m)</i>	84–129	1–5

Animal community

Rhizomatous Wheatgrasses/ Needleandthread/Big Bluestem Plant Community (Reference): The predominance of grasses in this plant community favors grazers and mixed-feeders, such as bison, elk, and antelope. Suitable thermal and escape cover for deer may be limited due to the low quantities of woody plants. However, topographical variations could provide some escape cover. When found adjacent to sagebrush dominated states, this plant community may provide brood rearing/foraging areas for sage grouse, as well as lek sites. Other birds that would frequent this plant community include Western meadowlarks, horned larks, and golden eagles. Many grassland obligate small mammals would occur here.

Mixed Sagebrush/Grass Plant Community: The combination of an overstory of sagebrush and an understory of grasses and forbs provide a very diverse plant community for wildlife. The crowns of sagebrush tend to break up hard crusted snow on winter ranges, so mule deer and antelope may use this state for foraging and cover year-round, as would cottontail and jack rabbits. It provides important winter, nesting, brood-rearing, and foraging habitat for sage grouse. Brewer's sparrows' nest in big sagebrush plants, and hosts of other nesting birds utilize stands in the 20-30% cover range.

Heavy Sagebrush Plant Community: This plant community can provide important winter foraging for elk, mule deer and antelope, as sagebrush can approach 15% protein and 40-60% digestibility during that time. This community provides excellent escape and thermal cover for large ungulates, as well as nesting and brood rearing habitat for sage grouse.

Western Wheatgrass/Cheatgrass Plant Community: This plant community may be useful for the same large grazers that would use the Historic Climax Plant Community. However, the plant community composition is less diverse, and thus, less apt to meet the seasonal needs of these animals. It may provide some foraging opportunities for sage grouse when it occurs proximal to woody cover. Good grasshopper habitat equals good foraging for birds.

Blue Grama Sod and Go-back Land Plant Communities: These communities provide limited foraging for antelope and other grazers. They may be used as a foraging site by sage grouse if proximal to woody cover and if the Historic Climax Plant Community or the Western Wheatgrass/Cheatgrass Plant Community is limiting. Generally, these are not target plant communities for wildlife habitat management.

Greasewood Plant Community: This plant community exhibits a low level of plant species diversity due to the

accumulation of salts in the soil. It may provide some thermal and escape cover for deer and antelope if no other woody community is nearby, but in most cases it is not a desirable plant community to select as a wildlife habitat management objective.

Blue Grama, Plains Pricklypear/Bare Ground Plant Community: Benefits to other wildlife are largely due to the subterranean structure created by the prairie dogs, not the sparse vegetation found on this plant community.

Animal Community – Grazing Interpretations

The following table lists suggested stocking rates for cattle under continuous season-long grazing under normal growing conditions. These are conservative estimates that should be used only as guidelines in the initial stages of the conservation planning process. Often, the current plant composition does not entirely match any particular plant community (as described in this ecological site description). Because of this, a field visit is recommended, in all cases, to document plant composition and production. More precise carrying capacity estimates should eventually be calculated using this information along with animal preference data, particularly when grazers other than cattle are involved. Under more intensive grazing management, improved harvest efficiencies can result in an increased carrying capacity. If distribution problems occur, stocking rates must be reduced to maintain plant health and vigor.

Plant Community Production Carrying Capacity* (lb./ac) (AUM/ac)

Rhizomatous WG/ Needleandthread/ Big Bluestem	1500-2300	.5
Heavy Sagebrush	900-1500	.35
Blue Grama Sod	450-1100	.25
Mixed Sagebrush/Grass	1000-1800	.4
Western Wheatgrass/Cheatgrass	750-1250	.3
Blue grama/Plains Pricklypear/ Bare ground	400-800	.1
Greasewood	700-1200	.25
Go-back Land	600-1200	.25

* - Continuous, season-long grazing by cattle under average growing conditions.

Grazing by domestic livestock is one of the major income-producing industries in the area. Rangeland in this area may provide yearlong forage for cattle, sheep, or horses. During the dormant period, the forage for livestock use needs to be supplemented with protein because the quality does not meet minimum livestock requirements.

Hydrological functions

Water is the principal factor limiting forage production on this site. This site is dominated by soils in hydrologic group B and C, with localized areas in hydrologic group D. Infiltration and runoff potential for this site varies from moderate to high depending on soil hydrologic group and ground cover. In many cases, areas with greater than 75% ground cover have the greatest potential for high infiltration and lower runoff. An example of an exception would be where short-grasses form a strong sod and dominate the site. Areas where ground cover is less than 50% have the greatest potential to have reduced infiltration and higher runoff (refer to Section 4, NRCS National Engineering Handbook for runoff quantities and hydrologic curves).

Rills and gullies should not typically be present. Water flow patterns should be barely distinguishable if at all present. Pedestals should not be present. Litter typically falls in place, and signs of movement are not common. Chemical and physical crusts are rare to non-existent. Cryptogamic crusts are present, but only cover 1-2% of the soil surface.

Recreational uses

This site provides hunting opportunities for upland game species. The wide variety of plants which bloom from spring until fall have an esthetic value that appeals to visitors.

Wood products

No appreciable wood products are present on the site.

Other products

None noted.

Other information

Site Development & Testing Plan

General Data (MLRA and Revision Notes, Hierarchical Classification, Ecological Site Concept, Physiographic, Climate, and Water Features, and Soils Data):

Updated. All "Required" items complete to Provisional level.

Community Phase Data (Ecological Dynamics, STM, Transition & Recovery Pathways, Reference Plant Community, Species Composition List, Annual Production Table):

Updated. All "Required" items complete to Provisional level.

Annual Production Table is from the "Previously Approved" ESD (2001).

The Annual Production Table and Species Composition List will be reviewed for future updates at the Approved level.

Each Alternative State/Community:

Complete to Provisional level.

Supporting Information (Site Interpretations, Assoc. & Similar Sites, Inventory Data References, Agency/State Correlation, References):

Updated. All "Required" items complete to Provisional level.

Wildlife Interpretations: Narrative is from "Previously Approved" ESD (2001). Wildlife species will need to be updated at the next Approved level.

Livestock Interpretations: Plant community names and stocking rates updated.

Hydrology, Recreational Uses, Wood Products, and Other Products carried over from previously "Approved" ESD (2001).

Existing NRI Inventory Data References updated. More field data collection is needed to support this site concept.

Reference Sheet

Rangeland Health Reference Sheet carried over from previously "Approved" ESD (2005).

It will be updated at the next "Approved" level.

"Future work, as described in a project plan, to validate the information in this provisional ecological site description is needed. This will include field activities to collect low and medium intensity sampling, soil correlations, and analysis of that data. Annual field reviews should be done by soil scientists and vegetation specialists. A final field review, peer review, quality control, and quality assurance reviews of the ESD will be needed to produce the final document." (NI 430_306 ESI and ESD, April 2015)

Inventory data references

Inventory information has been derived from data collection on private and federal lands by the following methods:

- Double Sampling (Determining Vegetation Production and Stocking Rates, WY-ECS-1)
- Rangeland Health (Interpreting Indicators of Rangeland Health, Version 4, 2005)
- Soil Stability (Interpreting Indicators of Rangeland Health, Version 4, 2005)

- Line Point Intercept (Monitoring Manual for Grassland, Shrubland, and Savanna Ecosystems, Volume II, 2005)
- Soil Pedon Descriptions (Field Book for Describing and Sampling Soils, Version 3, 2012)
- SCS-RANGE-417 (Production & Composition Record for Native Grazing Lands)

National Resources Inventory (NRI) Data

- Number of Records: 35
- Sample Period: 2004-2017
- State: Wyoming
- Counties: Campbell, Crook, Johnson, Natrona, Niobrara, Sheridan

Additional reconnaissance data collection includes ocular estimates and other inventory data; vegetative clipping data for NRCS program support; field observations from experienced rangeland personnel

Data collection for this ecological site was done in conjunction with the progressive soil surveys within MLRA 58B Northern Rolling High Plains (Southern Part)

Note: Revisions to soil surveys are on-going. For the most recent updates, visit the Web Soil Survey, the official site for soils information: <http://websoilsurvey.nrcs.usda.gov/app/WebSoilSurvey.aspx>

Other references

Dormaar, J.F., and S. Smoliak. 1985. Recovery of vegetative cover and soil organic matter during revegetation of abandoned farmland in a semiarid climate. *Journal of Range Management* 38:487-491.

Federal Geographic Data Committee. 2008. The National Vegetation Classification Standard, Version 2. FGDC Vegetation Subcommittee. FGDC-STD-005-2008 (Version 2). pp. 126.

Herrick JE, Van Zee J, Havstad K, Burkett LM, Whitford WG. 2005. Monitoring Manual for Grassland, Shrubland, and Savanna Ecosystems, Volume II. Tucson, AZ. University of Arizona Press – Distributor.

Land Resource Regions and Major Land Resource Areas of the United States, the Caribbean, and the Pacific Basin. USDA Handbook 296. USDA Natural Resources Conservation Service. 2006.

McNab, W.H., et al. 2007. Description of Ecological Sub-Regions: Sections of the Conterminous United States. USDA Forest Service. General Technical Report WO-76B.

Pellant M., Shaver P., Pyke D., Herrick JE. 2005. Interpreting Indicators of Rangeland Health, Version 4.0. Technical Reference 1734-6. Denver, CO. USDI Bureau of Land Management, NSTC, Division of Science Integration, Branch of Publishing Services.

Samuel, M.J., and R.H. Hart. 1994. Sixty-one years of secondary succession on rangelands of the Wyoming High Plains. *Journal of Range Management* 47:184-191.

Schoeneberger, Wysocki, Benham, and Soil Science Division Staff. 2012. Field Book for Describing and Sampling Soils, Version 3. Washington, DC. United States Government Publishing Office (GPO).

Soil Science Division Staff. USDA Natural Resources Conservation Service. 2014. Keys to Soil Taxonomy, 12th Edition.

Soil Science Division Staff. USDA Natural Resources Conservation Service. 2017. Soil Survey Manual, Agriculture Handbook No. 18.

Soil Science Division Staff. USDA Natural Resources Conservation Service. 2019. National Soil Survey Handbook, Title 430-VI. http://www.nrcs.usda.gov/wps/portal/nrcs/detail/soils/ref/?cid=nrcs142p2_054242 (Accessed 16 January, 2018).

Soil Science Division Staff. USDA Natural Resources Conservation Service. National Soil Information System (NASIS) Database. https://www.nrcs.usda.gov/wps/portal/nrcs/detail/soils/survey/geo/?cid=nrcs142p2_053552

(Accessed 30 October, 2017).

Soil Science Division Staff. USDA Natural Resources Conservation Service. Official Soil Series Descriptions. https://www.nrcs.usda.gov/wps/portal/nrcs/detail/soils/home/?cid=nrcs142p2_053587 (Accessed 15 November, 2017).

Soil Science Division Staff. USDA Natural Resources Conservation Service. Soil Survey Geographic (SSURGO) Database.

Soil Science Division Staff. USDA Natural Resources Conservation Service. Web Soil Survey. <https://websoilsurvey.nrcs.usda.gov/app/HomePage.htm> (Accessed 15 February, 2018).

Stubbenieck, James, S.L. Hatch, and L.M. Landholt. 2003. North American Wildland Plants. University of Nebraska Press, Lincoln and London.

United States Department of Commerce, National Oceanic and Atmospheric Administration (NOAA). Cooperative Climatological Data Summaries. NOAA Western Regional Climate Center, Reno, NV. <http://www.wrcc.dri.edu/climatedata/climsum> (Accessed 16 November, 2017).

United States Department of the Interior, Geological Survey. LANDFIRE 1.1.0 Existing Vegetation Types. 2011. <http://landfire.cr.usgs.gov/viewer/>.

United States Department of the Interior, Geological Survey. LANDFIRE 1.1.0 Vegetation Dynamics Models. 2008. <http://landfire.cr.usgs.gov/viewer/>.

United States Environmental Protection Agency, National Health and Environmental Effects Research Laboratory. 2013. Level III Eco-Regions of the Continental United States. <https://www.epa.gov/eco-research/ecoregions> (Accessed 30 January, 2019).

USDA Forest Service. Fire Effects Information System. <http://www.fs.fed.us/database/feis/plants/shrub/amealn/all.html>.

USDA Natural Resources Conservation Service, USDA Forest Service, USDI Bureau of Land Management. January 2013. Interagency Ecological Site Handbook for Rangelands.

USDA Natural Resources Conservation Service. 2006. Land Resource Regions and Major Land Resource Areas of the United States, the Caribbean, and the Pacific Basin. USDA Handbook 296.

USDA Natural Resources Conservation Service. Climate Data. National Water and Climate Center. <https://www.wcc.nrcs.usda.gov/climate> (Accessed 13 October, 2017).

USDA Natural Resources Conservation Service. Glossary of Landform and Geologic Terms. National Soil Survey Handbook, Title 430-VI, Part 629.02c. http://www.nrcs.usda.gov/wps/portal/nrcs/detail/soils/ref/?cid=nrcs142p2_054242 (Accessed 16 January, 2018).

USDA Natural Resources Conservation Service. National Cooperative Soil Survey. <https://www.nrcs.usda.gov/wps/portal/nrcs/main/soils/survey/partnership/ncss/>.

USDA Natural Resources Conservation Service. National Ecological Site Handbook, Title 190. March 2017. <https://directives.sc.egov.usda.gov/> (Accessed 15 September, 2017).

USDA Natural Resources Conservation Service. National Range and Pasture Handbook. 1997, Revised 2003. <http://www.glti.nrcs.usda.gov/technical/publications/nrph.html> (Accessed 26 February, 2018).

USDA Natural Resources Conservation Service. NRCS Plants Database. <https://plants.usda.gov/java/>.

Watts, M.J., and C.L. Wambolt. 1996. Long-term recovery of Wyoming big sagebrush after four treatments. *Journal of Environmental Management* 46:95-102.

Contributors

Everett Bainter
Glenn Mitchell

Approval

Kirt Walstad, 10/04/2023

Acknowledgments

Project Staff:

Kimberly Diller, Ecological Site Specialist, NRCS MLRA SSO, Pueblo CO
Mike Leno, Project Leader, NRCS MLRA SSO, Buffalo WY

Partners/Contributors:

Joe Dyer, Soil Scientist, NRCS MLRA SSO, Buffalo WY
Arnie Irwin, Soil Scientist, BLM, Buffalo WY
Blaine Horn, Rangeland Extension Educator, UW Extension, Buffalo WY
Isabelle Giuliani, Resource Soil Scientist, NRCS, Douglas WY
Mary Jo Kimble, Project Leader, NRCS MLRA SSO, Miles City MT
Ryan Murray, Area Rangeland Management Specialist, NRCS, Buffalo WY
Lauren Porensky, PhD, Ecologist, ARS, Fort Collins CO
Chadley Prosser, Rangeland Program Manager, USFS, Bismarck ND
Bryan Christensen, Ecological Site Specialist, NRCS MLRA SSO, Pinedale WY
Marji Patz, Ecological Site Specialist, NRCS MLRA SSO, Powell WY
Rick Peterson, Ecological Site Specialist, NRCS MLRA SSO, Rapid City SD
Jeff Fenton, Ecological Site Specialist, NRCS MLRA SSO, Buffalo WY

Program Support:

John Hartung, WY State Rangeland Management Specialist (QC), NRCS, Casper WY
David Kraft, Senior Regional Ecological Site Specialist (QA), NRCS, Emporia KS
Carla Green Adams, Editor, NRCS-SSR5, Denver CO
Chad Remley, Regional Director, Northern Central Soil Survey Region, Salina KS

Rangeland health reference sheet

Interpreting Indicators of Rangeland Health is a qualitative assessment protocol used to determine ecosystem condition based on benchmark characteristics described in the Reference Sheet. A suite of 17 (or more) indicators are typically considered in an assessment. The ecological site(s) representative of an assessment location must be known prior to applying the protocol and must be verified based on soils and climate. Current plant community cannot be used to identify the ecological site.

Author(s)/participant(s)	
Contact for lead author	
Date	05/01/2024
Approved by	Kirt Walstad
Approval date	
Composition (Indicators 10 and 12) based on	Annual Production

Indicators

1. **Number and extent of rills:**

2. **Presence of water flow patterns:**

3. **Number and height of erosional pedestals or terracettes:**

4. **Bare ground from Ecological Site Description or other studies (rock, litter, lichen, moss, plant canopy are not bare ground):**

5. **Number of gullies and erosion associated with gullies:**

6. **Extent of wind scoured, blowouts and/or depositional areas:**

7. **Amount of litter movement (describe size and distance expected to travel):**

8. **Soil surface (top few mm) resistance to erosion (stability values are averages - most sites will show a range of values):**

9. **Soil surface structure and SOM content (include type of structure and A-horizon color and thickness):**

10. **Effect of community phase composition (relative proportion of different functional groups) and spatial distribution on infiltration and runoff:**

11. **Presence and thickness of compaction layer (usually none; describe soil profile features which may be mistaken for compaction on this site):**

12. **Functional/Structural Groups (list in order of descending dominance by above-ground annual-production or live foliar cover using symbols: >>, >, = to indicate much greater than, greater than, and equal to):**

Dominant:

Sub-dominant:

Other:

Additional:

13. **Amount of plant mortality and decadence (include which functional groups are expected to show mortality or decadence):**

14. **Average percent litter cover (%) and depth (in):**

15. **Expected annual annual-production (this is TOTAL above-ground annual-production, not just forage annual-production):**

16. **Potential invasive (including noxious) species (native and non-native). List species which BOTH characterize degraded states and have the potential to become a dominant or co-dominant species on the ecological site if their future establishment and growth is not actively controlled by management interventions. Species that become dominant for only one to several years (e.g., short-term response to drought or wildfire) are not invasive plants. Note that unlike other indicators, we are describing what is NOT expected in the reference state for the ecological site:**

17. **Perennial plant reproductive capability:**
