

Ecological site F088XY004MN Acid Peatland

Last updated: 8/12/2024
Accessed: 09/27/2024

General information

Provisional. A provisional ecological site description has undergone quality control and quality assurance review. It contains a working state and transition model and enough information to identify the ecological site.

MLRA notes

Major Land Resource Area (MLRA): 088X–Northern Minnesota Glacial Lake Basins

MLRA 88 consists of the lake beds of glacial Lakes Agassiz, Upham, and Aitkin. These vast glacial lake beds were formed by meltwaters associated with the last glaciation of the Wisconsin age. The large, flat, wet landscapes are filled with lacustrine lake sediments, wave-washed glacial till, and vast expanses of organic soils. This area is entirely in Minnesota and makes up about 11,590 square miles (30,019 square kilometers).

The western boundary of MLRA 88 with MLRA 56B is gradual. MLRA 56B is a portion of the Red River Valley that was formed by glacial Lake Agassiz and is dominantly prairie. The southern boundary of MLRA 88 with MLRA 57 consists of distinct moraines that formed from the glacial drift sediments of Late Wisconsin age. The eastern and southeastern boundaries are with portions of MLRAs 90A and 93A. These MLRAs are in a distinct glaciated region of sediments of the Rainy and Superior Lobes, and much of MLRA 93A is bedrock controlled (USDA-Ag Handbook 296, 2022).

Classification relationships

Major Land Resource Area (MLRA): Northern Minnesota Glacial Lake Basins (88)

USFS Subregions: Northern Superior Uplands Section (212L); North Shore Highlands Subsection (212Lb)

Relationship to Other Established Classifications:

Minnesota Department of Natural Resources (MN DNR) APn80-Northern Spruce Bog, Acid Peatland System, Northern Floristic Region

MN DNR APn81-Northern Poor Conifer Bog, Acid Peatland System, Northern Floristic Region

MN DNR APn90–Northern Open Bog, Acid Peatland System, Northern Floristic Region

MN DNR APn91-Northern Poor Fen, Acid Peatland System, Northern Floristic Region

NatureServe

Association: *Picea mariana* - (*Larix laricina*) / *Ledum groenlandicum* / *Sphagnum* spp. Swamp Forest, NatureServe Element Code, CEG005271

Ecological site concept

The ecological site concept is a conifer-dominated acidic peatland with a sparse canopy, depauperate understory, and sphagnum hummocks. Surface water is acidic and low in minerals. Water table fluctuations are more variable than poor fens, but less variable than in forested bogs. (MN DNR, 2005).

Associated sites

F088XY005MN	Forestland Peatland Forestland Peatland occurs on level to gently sloping surfaces. Soils have greater than 16" of organic material and soil pH values are greater than 4.5. This site has a water table typically below the peat surface that drops during the summer to allow for the establishment of significant tree cover.
F088XY003MN	Open Peatland Open Peatland occurs on level to gently sloping surfaces. Soils have greater than 16" of organic material and soil pH values are greater than 4.5. This site has a high water table that remain near the surface throughout the growing season, preventing the establishment of significant tree cover.

Similar sites

F088XY005MN	Forestland Peatland Forestland Peatland occurs on level to gently sloping surfaces. Soils have greater than 16" of organic material and soil pH values are greater than 4.5. This site has a water table typically below the peat surface that drops during the summer to allow for the establishment of significant tree cover.
-------------	--

Table 1. Dominant plant species

Tree	(1) <i>Picea mariana</i> (2) <i>Larix laricina</i>
Shrub	(1) <i>Betula pumila</i> (2) <i>Ledum groenlandicum</i>
Herbaceous	(1) <i>Eriophorum vaginatum</i> (2) <i>Sphagnum</i>

Physiographic features

This site occurs on depressions, bog landforms on till plains, moraines, outwash plains, till plains and lake plains. Sites are nearly level and the organic soils are typically saturated to the surface from the water table. The buildup of organic materials over time has led to the development of a crested microtopography on these sites.

Table 2. Representative physiographic features

Slope shape across	(1) Linear
Slope shape up-down	(1) Linear
Landforms	(1) Till plain > Depression (2) Till plain > Raised bog (3) Till plain > Bog (4) Moraine (5) Outwash plain (6) Till plain (7) Lake plain
Runoff class	Negligible
Flooding frequency	None
Ponding frequency	None
Elevation	180–619 m
Slope	0–1%
Ponding depth	0 cm
Water table depth	0 cm
Aspect	Aspect is not a significant factor

Climatic features

The average annual precipitation is 25 to 28 inches (635 to 711 millimeters). Most of the rainfall comes from

convective thunderstorms during the growing season. Snowfall generally occurs from October through April. The average annual temperature is 43 to 46 degrees F (6 to 8 degrees C). The mean frost free period ranges from 86 to 110 days, with the mean freeze-free period ranging from 120 to 135 days.

Table 3. Representative climatic features

Frost-free period (characteristic range)	86-110 days
Freeze-free period (characteristic range)	120-135 days
Precipitation total (characteristic range)	635-711 mm
Frost-free period (actual range)	79-112 days
Freeze-free period (actual range)	114-141 days
Precipitation total (actual range)	610-711 mm
Frost-free period (average)	99 days
Freeze-free period (average)	129 days
Precipitation total (average)	660 mm

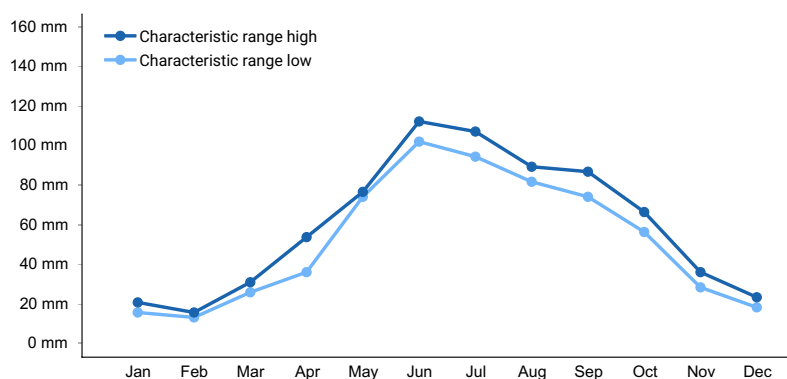

Figure 1. Monthly precipitation range

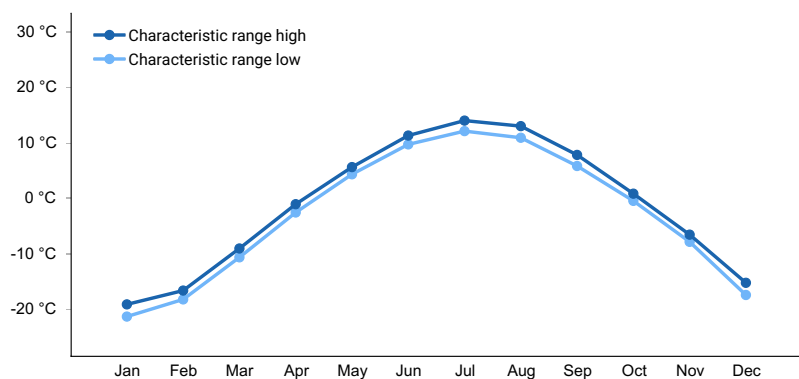

Figure 2. Monthly minimum temperature range

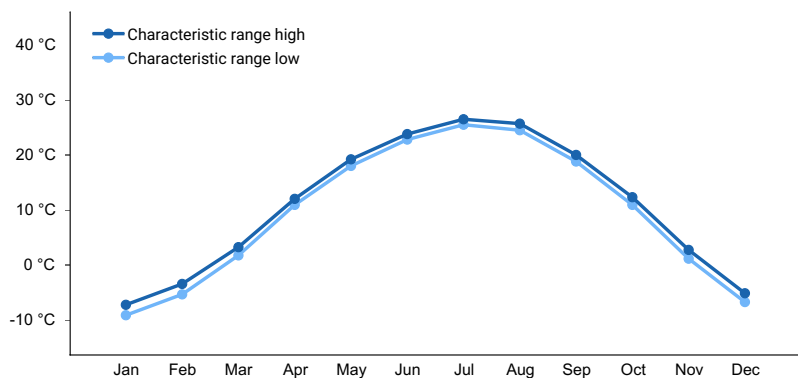

Figure 3. Monthly maximum temperature range

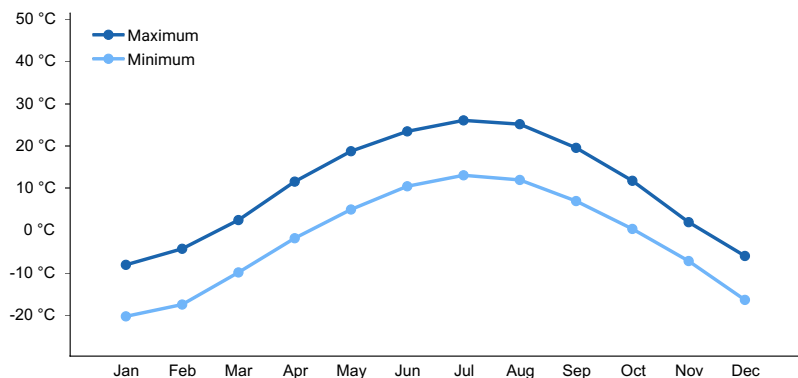

Figure 4. Monthly average minimum and maximum temperature

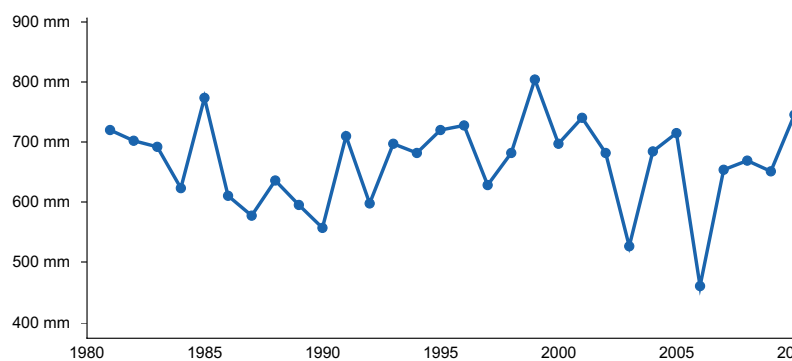

Figure 5. Annual precipitation pattern

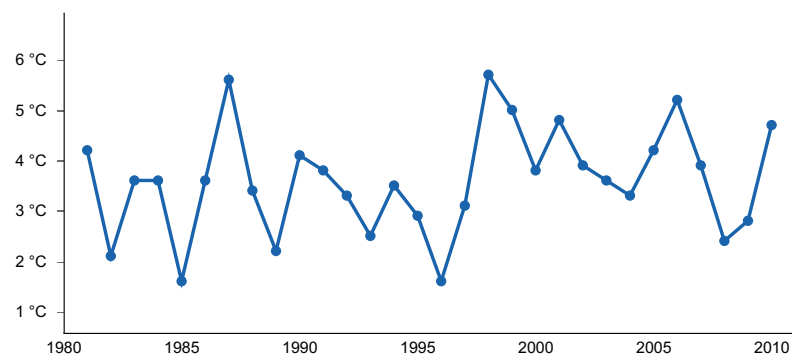

Figure 6. Annual average temperature pattern

Climate stations used

- (1) WARROAD [USC00218679], Warroad, MN
- (2) CAMP NORRIS DNR [USC00211250], Beltrami Isl State for, MN
- (3) BAUDETTE INTL AP [USW00094961], Baudette, MN

- (4) WASKISH 4NE [USC00218700], Big Falls, MN
- (5) RED LAKE INDIAN AGCY [USC00216795], Ponemah, MN
- (6) BIG FALLS [USC00210746], Big Falls, MN
- (7) LITTLEFORK 10 SW [USC00214809], Big Falls, MN
- (8) INTL FALLS INTL AP [USW00014918], International Falls, MN
- (9) LEECH LAKE [USC00214652], Bena, MN
- (10) POKEGAMA DAM [USC00216612], Cohasset, MN
- (11) GRAND RPDS FOREST LAB [USC00213303], Grand Rapids, MN
- (12) SANDY LAKE DAM LIBBY [USC00217460], McGregor, MN
- (13) FLOODWOOD 3 NE [USC00212842], Floodwood, MN
- (14) EVELETH WWTP [USC00212645], Eveleth, MN

Influencing water features

Water is received through precipitation, runoff from adjacent uplands, and groundwater. Water levels are greatly influenced by precipitation rates and runoff from upland sites. Water leaves the site primarily through evapotranspiration, groundwater recharge, and less often, stream outflow. These sites are wetlands.

The hydrology of acid peatland sites significantly impacts their ecological development. Groundwater movement into these sites brings in water that is exposed to surrounding acidic parent materials, such as sand deposits. This interaction keeps the soils acidic.

Wetland description

Under the Cowardin System of Wetland Classification, or National Wetlands Inventory (NWI), the wetlands can be classified as:

- 1) Palustrine, forested, needle-leaved evergreen, saturated, or
- 2) Palustrine, scrub-shrub, broad-leaved deciduous, saturated, or
- 3) Palustrine, scrub-shrub, broad-leaved evergreen, saturated, or
- 4) Palustrine, emergent, persistent, saturated

Under the Hydrogeomorphic Classification System (HGM), the wetlands can be classified as:

- 1) Depressional, acidic, forested/organic, or
- 2) Depressional, acidic, scrub-shrub/organic

Permeability of the soil is very slow to moderately slow.

Hydrologic Group: A/D, B/D, C/D

Hydrogeomorphic Wetland Classification: Depressional acidic forested/organic; Depressional acidic scrub-shrub/organic

Cowardin Wetland Classification: PFO4B, PSS4B, PSS3B, PEM1B

Soil features

Acid Peatland soils developed as organic materials. They are very poorly drained, deep, and have relatively high available water capacity (13.4 to 17.7). Parent material is fibric and/or herbaceous organic material more than 40 centimeters thick. Underlying impermeable layers minimize groundwater movement through the peat. The main source of water to the site is precipitation, since the site formed through a buildup of peat over thousands of years, causing the soil surface to develop a crest shape with sloping concave sides.

All soils in the Acid Peatland ecological site are Histosols. Soils for this site can be further described as Hemic Sphagnofibrists, Typic Borohemists, Typic Haplohemists, and Typic Shpagnofibrists.

The soil series included in the Acid Peatland ecological site include Greenwood, Lobo, Waskish, and Borohemists.

Table 4. Representative soil features

Parent material	(1) Organic material
Surface texture	(1) Peat

Drainage class	Very poorly drained
Permeability class	Moderately rapid to rapid
Depth to restrictive layer	0 cm
Soil depth	203 cm
Surface fragment cover <=3"	0%
Surface fragment cover >3"	0%
Available water capacity (0-101.6cm)	47.5–57.4 cm
Subsurface fragment volume <=3" (0cm)	Not specified
Subsurface fragment volume >3" (0cm)	Not specified

Ecological dynamics

Parent material is fibric and/or herbaceous organic material more than 40 centimeters thick. These sites usually formed in depressions on glacial moraines and lacustrine and outwash plains, where underlying impermeable layers minimize groundwater movement through the peat. Slopes are less than 2%. The surface water on-site is very acidic (pH <4.2), and mineral concentrations (particularly Ca⁺⁺) are extremely low. Mean annual precipitation is about 30 inches, and mean annual temperature is about 43 degrees F. The water table is usually at or near the surface but can drop during periods of drought. The main source of water to the site is precipitation, since the site formed through a buildup of peat over thousands of years, causing the soil surface to develop a crest shape with sloping concave sides, and therefore to become isolated from mineral-rich runoff or subsurface flow. Water does pond on these sites, but it is not frequently ponded for very long durations for at least 7 out of 12 months.

For the past 6,000 years the climate of Minnesota has favored the swamping, or paludification, of terrestrial sites (MN DNR 2003). This process, led by stabilization and rising of water tables, peat accumulation, and increased acidification by Sphagnum mosses, elevates the soil surface above groundwater. Precipitation then becomes the primary source of water for plants, and dust (dryfall) the primary source of nutrients. The resulting environment favors self-perpetuation of peat accumulation (rather than nutrient recycling) and further acidification. This process began thousands of years ago in rich forested swamps or poor fens, and typically followed a unidirectional succession over centuries starting with the Young Tamarack phase and succeeding through a Mature Tamarack-Spruce phase to a Spruce Bog (MN DNR 2003).

However, some disturbances can reset this cycle, reverting the acidification process, resulting in richer communities. In Acid Peatlands, fires were not very common historically, perhaps because of the landscape position and wetness of peatland basins. Public Land Survey (PLS) records indicate that catastrophic fires had a recurrence interval somewhere between 500 - 1,000 years, and lighter (superficial) fires about every 90 - 120 years, likely during drought (MNDNR 2003). If fires were intense enough to kill the overstory and burn the peat, releasing nutrients and allowing even a small connection back to the groundwater, the site could be converted to a rich swamp (MNDNR Forestry). Windthrow was also a common, although typically minor, source of disturbance for the site (90 – 120 years), with catastrophic windthrow occurring approximately every 500 – 700 years. Recovery post-disturbance to forested conditions may take decades in these peatlands. Historically, caribou and moose would utilize these sites for forage, thermal regulation, and as migratory paths. These trails are still evident today (due in large part to the damage repeated compaction can do to peat) even though caribou were extirpated from Minnesota in the 1940s (MN DNR Forestry).

State and transition model

Ecosystem states

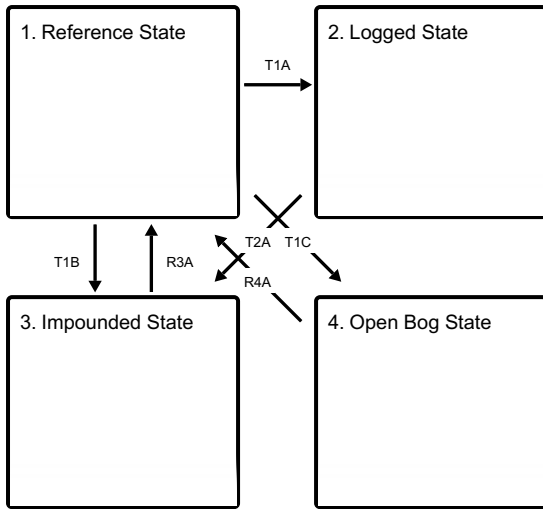

T1A - Logging, seeding.

T1B - Impoundment or maintenance of water on-site, and/or establishment of invasive species.

T1C - Beaver activity, roads, drainage, and other alterations in hydrology.

T2A - Poorly logged peatlands that are excessively clearcut combined with severe rutting or road building can result in impoundment.

R3A - Unblocking road culverts that cause ponding, filling in drainage ditches that are perennially blocked and impounded by beaver activity, etc.

R4A - Draining or maintenance of water on-site causing alterations in hydrology.

State 1 submodel, plant communities

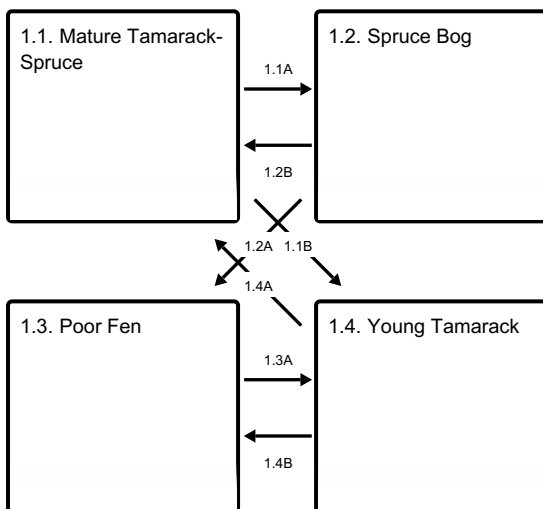

1.1A - Lack of fire, accumulation of peat, lowering of pH<5.0

1.1B - Surface fires or windthrow or higher than average precipitation

1.2B - Neutralization of acids on-site raising of pH

1.2A - Fire, if peat depth is lowered and thereby allowing roots of plants to access groundwater or higher than average precipitation

1.3A - Time, accumulation of peat

1.4A - Time, accumulation of peat, acidification, establishment and growth of older trees.

1.4B - Severe catastrophic fire or windthrow or higher than average precipitation

State 1 Reference State

Moss cover is very indicative for this site, driving the successional dynamics and species diversity. Sphagnum sp. absorb dissolved mineral cations, and release organic acids, which lowers the pH of stagnant surface water below 5.0 (MN DNR 2003). Sphagnum tends to form carpets of hummocks, which creates an acidic environment cut off from groundwater and on-site ponding. In recently developed bogs, on sites mostly in the western range of the MLRA where soils are less continuously saturated, on sites where water table fluctuations are less variable, or on

inclusions of sites where there are upwellings of groundwater, isolated minerotrophic species (i.e. creeping sedge or bluejoint) may be present. Other ground cover includes fine-leaved graminoids, and minimal presence of forbs. Occasionally, seedlings of deciduous tree species associated with adjacent sites (i.e. red maple or paper birch) may become established on Sphagnum hummocks but typically do not survive to become saplings or trees (MN DNR 2003). The overstory usually consists of scattered, stunted (<30ft [10m] tall) black spruce or tamarack (<50% cover) where Sphagnum hummocks provide relief from surface flooding (MN DNR Forestry). Most vascular plants associated with Acid Peatlands have a strong association with mycorrhizal fungi, depending on them to obtain minerals and nutrients in this depauperate and harsh environment (MN DNR 2003). These fungi are more diverse on this ecological site than on other sites throughout the region.

Dominant plant species

- black spruce (*Picea mariana*), tree
- tamarack (*Larix laricina*), tree
- bog willow (*Salix pedicellaris*), shrub
- creeping snowberry (*Gaultheria hispidula*), shrub
- creeping sedge (*Carex chordorrhiza*), grass
- bluejoint (*Calamagrostis canadensis*), grass
- sphagnum (*Sphagnum fuscum*), other herbaceous
- sphagnum (*Sphagnum angustifolium*), other herbaceous
- papillose sphagnum (*Sphagnum papillosum*), other herbaceous
- sphagnum (*Sphagnum subsecundum*), other herbaceous
- sphagnum (*Sphagnum majus*), other herbaceous
- polytrichum moss (*Polytrichum strictum*), other herbaceous
- aulacomnium moss (*Aulacomnium palustre*), other herbaceous
- Schreber's big red stem moss (*Pleurozium schreberi*), other herbaceous
- (*Cladopodiella fluitans*), other herbaceous
- Fern or Fern Ally (*Fern or Fern Ally*), other herbaceous
- clubmoss (*Lycopodiella*), other herbaceous
- Liverwort (*Liverwort*), other herbaceous
- bunchberry dogwood (*Cornus canadensis*), other herbaceous

Community 1.1

Mature Tamarack-Spruce

Overstory occasionally has tamarack but is mostly dominated by black spruce, most likely due to the longer lifespan of the spruce trees. In cases where tamarack is monotypic, it is usually due to a lack of seed source for black spruce, or mortality of black spruce caused by species-specific insects or disease (MN DNR Forestry). Sometimes, paper birch can be present in the canopy. In this phase, tree growth is fairly stagnant, although stocking and tree height are higher than in the Young Tamarack phase (1.4). The moss layer is dominated by Sphagnum sp., between which in the hollows can be found brown mosses. In cases where tree growth exceeds 50% canopy cover, more shade-tolerant species can be present in the understory, including creeping snowberry, soft-leaved sedge, ferns, clubmosses, groundpines, and bunchberry (MN DNR 2003).

Community 1.2

Spruce Bog

Some scattered tamarack may still remain in the overstory, but mostly the sites are dominated by black spruce. On well-developed crests of older sites, trees can reach up to 30 ft tall, making them more desirable for timber harvesting. While the few graminoids and forbs may remain the same as in 1.1, fewseed sedge and boreal bog sedge are more indicative of this phase. In this phase, the Sphagnum has accumulated and typically forms large carpets with greater hummocks, along with Pleurozium. In this plant community phase acidity is the lowest of all of the plant community phase. Only true bog species remain, with no minerotrophic indicator species left.

Community 1.3

Poor Fen

In this phase, the overstory is often stunted (<30 ft [10m]). This phase is characterized by the presence of light-

loving species that can tolerate more water-logged conditions, where the water source may contain more nutrients. In general, the elevated water table inhibits the establishment or growth of tree species, although with enough time, Sphagnum hummocks can provide a refuge for further tree growth or recruitment (MN DNR 2003). Shrub cover can vary greatly, but the presence of a few minerotrophic species (bog willow) can help distinguish this phase from the Spruce Bog (1.2). Moss and liverwort cover is almost always near 100%, and can include oligotrophic *Sphagnum angustifolium* and *S. papillosum* in hollows, as well as minerotrophic *S. subsecundum*, *S. majus* forming carpets. *Polytrichum strictum*, *Aulacomnium palustre*, and *Pleurozium schreberi* are also common, as well as the liverwort *Cladopodiella fluitans*, which is an indicator for this phase.

Community 1.4

Young Tamarack

Pathway 1.1A

Community 1.1 to 1.2

Lack of fire, accumulation of peat, lowering of pH<5.0

Pathway 1.1B

Community 1.1 to 1.4

Surface fires or windthrow or higher than average precipitation

Pathway 1.2B

Community 1.2 to 1.1

Neutralization of acids on-site raising of pH

Context dependence. Alterations in hydrology which result in the alkalization of bogs, or fire disturbances that can result in mineral inputs from outside sources that offset depletion of cations (especially Ca⁺⁺) by *Sphagnum* sp, (even groundwater inputs of <5% of the total water budget relative to precipitation) can revert the process of peat accumulation and acidification, and result in a community type with more minerotrophic

Pathway 1.2A

Community 1.2 to 1.3

Fire, if peat depth is lowered and thereby allowing roots of plants to access groundwater or higher than average precipitation.

Context dependence. Typically, the interval of surface fires are approximately 120 years. Pockets of poor fen vegetation can develop in a spruce bog where alkalization of the bog occurs on the lower flanks of the crest, where the water source can receive nutrients from surface runoff, or where the runoff is channeled into drains or water tracks. The transition of the entire site to poor fen can occur on a broader scale when fire release nutrients and burn peat, reducing tree cover, reducing evapotranspiration and increasing water-logged conditions, resulting in even minimal groundwater and nutrient inputs to the site.

Pathway 1.3A

Community 1.3 to 1.4

Time, accumulation of peat.

Context dependence. This pathway usually occurs naturally with enough time for peat to accumulate and elevate the growing surface out of water-logged conditions, so that tree growth and recruitment can be more successful.

Pathway 1.4A

Community 1.4 to 1.1

Time, accumulation of peat, acidification, establishment and growth of older trees.

Pathway 1.4B

Community 1.4 to 1.3

Severe catastrophic fire or windthrow or higher than average precipitation

State 2

Logged State

In this state, the vegetation usually exhibits a structural pattern of “hard” edges which does not mimic the patch-scale distribution of canopy gaps we see from natural disturbances. Compositional changes in this state, as a diversion from reference, can be concerning, most notably the reversal of abundance of tamarack and black spruce (MN DNR Forestry). Tamarack regeneration has proven problematic for management, and can be susceptible to devastating outbreaks of larch sawfly and larch beetles. Tamarack regeneration in this state could be accomplished by leaving some tamarack seedtrees rather than always clear-cutting and seeding just black spruce (MN DNR Forestry). Harvesting should always be done in this state when the entire peat surface is frozen, although even then just a few passes with heavy equipment can damage the structural integrity of the site, or damage standing trees, thus prohibiting tree regeneration or maintenance on-site. In the field, areas identified by the presence of broad-leaved sedges and rough alder have far less structural integrity than the Sphagnum mat and should be avoided at all costs by heavy equipment. When dwarf mistletoe is present, control of the disease through broadcast burning, or by use of the “5 foot cutting rule”, can eradicate the disease, but success is dependent on total elimination of all living black spruce, and treatments (hand cutting, winter shearing, herbicides, combination treatments) need to be continued for 10 years after the initial harvest (MN DNR Forestry).

Dominant plant species

- tamarack (*Larix laricina*), tree
- black spruce (*Picea mariana*), tree
- bluejoint (*Calamagrostis canadensis*), grass
- creeping sedge (*Carex chordorrhiza*), grass

State 3

Impounded State

In this state, the excess of water on-site for longer than normal duration typically results in the killing off of tamarack and spruce trees, and the establishment of invasive species such as Typha sp. or reed canary grass (*Phalaris arundinacea*). Sometimes, other graminoids (*Carex* sp.) can remain on site and form floating mats. Sometimes alder and willow shrubs will remain or establish on the edges.

Dominant plant species

- willow (*Salix*), shrub
- speckled alder (*Alnus incana* ssp. *rugosa*), shrub
- reed canarygrass (*Phalaris arundinacea*), grass
- sedge (*Carex*), grass
- narrowleaf cattail (*Typha angustifolia*), other herbaceous
- hybrid cattail (*Typha xglauca*), other herbaceous

State 4

Open Bog State

Possible open water. Develops where the peat becomes isolated from mineral rich runoff or groundwater. Mineral and nutrient inputs come from precipitation and deposition. The saturated conditions and quick accumulation of Sphagnum prevent or inhibit establishment/growth of black spruce and tamarack. Variation in species composition in the community occur.

Dominant plant species

- leatherleaf (*Chamaedaphne calyculata*), shrub
- fewseed sedge (*Carex oligosperma*), grass

- sphagnum (*Sphagnum fuscum*), other herbaceous
- purple pitcherplant (*Sarracenia purpurea*), other herbaceous

Transition T1A

State 1 to 2

This transition involves logging, usually clearcutting, but with reserves for seed sources, site preparation, control for disease and invasive species, and seeding, in order to maintain the site as a viable commercial timber harvesting state. This transition is only possible, or desirable, when the management is applied to phases in which radial growth has been prolific and trees have reached maturity, exhibiting taller, more commercially viable trees.

Transition T1B

State 1 to 3

Impoundment or maintenance of water on-site, and/or establishment of invasive species. Beaver activity, roads, blocked drainages, and other alterations in hydrology can transition the Acid Peatlands out of Reference to an Impounded State, where water is ponded on site for longer durations and receives excessive nutrients from overland surface flow.

Transition T1C

State 1 to 4

Impoundment or maintenance of water on-site. Beaver activity, roads, drainage, and other alterations in hydrology can transition the Acid Peatlands out of Reference to an Open State, where water is on site for longer durations and receives excessive nutrients from overland surface flow causing stunted tree growth.

Transition T2A

State 2 to 3

Poorly logged peatlands that are excessively clearcut combined with severe rutting or road building can result in impoundment.

Restoration pathway R3A

State 3 to 1

Unblocking road culverts that cause ponding, filling in drainage ditches that are perennially blocked and impounded by beaver activity, etc.

Restoration pathway R4A

State 4 to 1

Draining or maintenance of water on-site causing alterations in hydrology that can transition the Open state back to the Reference State, where water is on site for shorter durations and receives less nutrients from overland surface flow causing increased tree growth

Additional community tables

Inventory data references

Information presented was derived from Minnesota Department of Natural Resources Field Guide to the Native Plant Communities of Minnesota, USDA-NRCS soil survey information, and USDA Plants Database.

Other references

Almendinger, J. C. 1997. Minnesota's Bearing Tree Database. Biological Report No. 56.

Brinson, M. M. 1993. A Hydrogeomorphic Classification for Wetlands.

Classification of Wetlands and Deepwater Habitats of the United States. Washington, DC: U.S. Fish and Wildlife Service, FWS/OBS-79/31.

Cleland, D.T.; Freeouf, J.A.; Keys, J.E., Jr.; Nowacki, G.J.; Carpenter, C; McNab, W.H. 2007. Ecological Subregions: Sections and Subsections of the Conterminous United States.[1:3,500,000], Sloan, A.M., cartog. Gen. Tech. Report WO-76. Washington, DC: U.S. Department of Agriculture, Forest Service.

Cowardin, L. M., V. Carter, F. C. Golet, and E. T. LaRoe. 1979.

Ecological Land Classification Program, Minnesota County Biological Survey, and Natural Heritage and Nongame Research Program. MNDNR St. Paul, MN.

Interpretations - Silviculture Program APn81. Retrieved at https://www.dnr.state.mn.us/forestry/ecs_silv/interpretations.html

Minnesota Department of Natural Resources. St. Paul, Minnesota, USA. MN DNR Forestry. Accessed 2018, June 13.

Minnesota Department of Natural Resources (2003). Field Guide to the Native Plant Communities of Minnesota: The Laurentian Mixed Forest Province.

Official Soil Series Descriptions. Available online. Accessed March 2018.

Soil Survey Staff, Natural Resources Conservation Service, United States Department of Agriculture.

United States Department of Agriculture, Natural Resources Conservation Service. 2022. Land Resource Regions and Major Land Resource Areas of the United States, the Caribbean, and the Pacific Basin. U.S. Department of Agriculture Handbook 296.

USDA, NRCS. 2018. The PLANTS Database (<http://plants.usda.gov>, 26 June 2018). National Plant Data Team, Greensboro, NC 27401-4901 USA.

U.S. Environmental Protection Agency. 2013. Level III and IV ecoregions of the continental United States: Corvallis, Oregon, U.S. EPA, National Health and Environmental Effects Research Laboratory, map scale 1:3,000,000, <https://www.epa.gov/eco-research/level-iii-and-iv-ecoregions-continental-united-states>.

Wetlands Research Program Technical Report WRP-DE-4, U.S. Army Corps of Engineers Waterways Experiment Station, Vicksburg, MS.

Contributors

Kade Anderson, Ecological Site Specialist for North Central Region
Patty Burns, Soil Scientist at Bemidji Soil Survey Office
Stacey Clark, Former Regional Ecologist for Regions 10 & 11
Ezra Hoffman, Ecological Site Specialist for North Central Region
Landon Wolter, Rangeland Management Specialist for North Central Region

Approval

Suzanne Mayne-Kinney, 8/12/2024

Rangeland health reference sheet

Interpreting Indicators of Rangeland Health is a qualitative assessment protocol used to determine ecosystem condition based on benchmark characteristics described in the Reference Sheet. A suite of 17 (or more) indicators are typically considered in an assessment. The ecological site(s) representative of an assessment location must be known prior to applying the protocol and must be verified based on soils and climate. Current plant community

cannot be used to identify the ecological site.

Author(s)/participant(s)	
Contact for lead author	
Date	09/27/2024
Approved by	Suzanne Mayne-Kinney
Approval date	
Composition (Indicators 10 and 12) based on	Annual Production

Indicators

1. **Number and extent of rills:**

2. **Presence of water flow patterns:**

3. **Number and height of erosional pedestals or terracettes:**

4. **Bare ground from Ecological Site Description or other studies (rock, litter, lichen, moss, plant canopy are not bare ground):**

5. **Number of gullies and erosion associated with gullies:**

6. **Extent of wind scoured, blowouts and/or depositional areas:**

7. **Amount of litter movement (describe size and distance expected to travel):**

8. **Soil surface (top few mm) resistance to erosion (stability values are averages - most sites will show a range of values):**

9. **Soil surface structure and SOM content (include type of structure and A-horizon color and thickness):**

10. **Effect of community phase composition (relative proportion of different functional groups) and spatial distribution on infiltration and runoff:**

11. **Presence and thickness of compaction layer (usually none; describe soil profile features which may be mistaken for compaction on this site):**

-
12. **Functional/Structural Groups (list in order of descending dominance by above-ground annual-production or live foliar cover using symbols: >>, >, = to indicate much greater than, greater than, and equal to):**

Dominant:

Sub-dominant:

Other:

Additional:

13. **Amount of plant mortality and decadence (include which functional groups are expected to show mortality or decadence):**
-

14. **Average percent litter cover (%) and depth (in):**
-

15. **Expected annual annual-production (this is TOTAL above-ground annual-production, not just forage annual-production):**
-

16. **Potential invasive (including noxious) species (native and non-native). List species which BOTH characterize degraded states and have the potential to become a dominant or co-dominant species on the ecological site if their future establishment and growth is not actively controlled by management interventions. Species that become dominant for only one to several years (e.g., short-term response to drought or wildfire) are not invasive plants. Note that unlike other indicators, we are describing what is NOT expected in the reference state for the ecological site:**
-

17. **Perennial plant reproductive capability:**
-