

# Ecological site R102AY040SD

## Loamy Floodplain

Last updated: 8/20/2024  
Accessed: 11/21/2024

---

### General information

**Provisional.** A provisional ecological site description has undergone quality control and quality assurance review. It contains a working state and transition model and enough information to identify the ecological site.

### MLRA notes

Major Land Resource Area (MLRA): 102A–Rolling Till Prairie

The Rolling Till Prairie (102A) is located within the Central Feed Grains and Livestock Land Resource Region. It spans 3 states (Minnesota 58 percent, South Dakota 42 percent, and small part in North Dakota), encompassing over 16,000 square miles (Figure 1). The elevation ranges from approximately over 2,000 feet above sea level (ASL) on the Prairie Coteau in Northeastern South Dakota to about 1,000 feet ASL on lowlands. The dominate landform in this area are stagnation moraines, end moraines, glacial outwash plains, terraces, and flood plains. The area is dominated by till covered moraines. The stagnation moraines are gently undulating to steep and have many depressions and poorly defined drainages. Small outwash areas are adjacent to the watercourses. The Cretaceous Pierre Shale underlies the till in the most of the area. Precambrian rocks also occur at depth. Granite is quarried near Milbank, South Dakota and outcrops of Sioux Quartzite are common. (USDA-NRCS 2006).

The dominant soil order in this MLRA is Mollisols. The soils in the area dominantly have a frigid soil temperature regime, an aquic or udic soil moisture regime, and mixed mineralogy. They generally are very deep, well drained to very poorly drained. This area supports true prairie vegetation characterized by big bluestem (*Andropogon gerardii*), little bluestem (*Schizachyrium scoparium*), porcupinegrass (*Hesperostipa spartea*), and green needlegrass (*Nassella viridula*). Prairie cordgrass (*Spartina pectinata*) commonly grows in wet areas. (USDA-NRCS 2006).

### Classification relationships

Major Land Resource Area (MLRA): Rolling Till Prairie (102A) (USDA-NRCS 2006)

USFS Subregions: North Central Glaciated Plains Section (251B); Upper Minnesota River-Des Moines Lobe Subsection (251Ba); Outer Coteau des Prairies Subsection (251Bb); Northwest Iowa Plains Subsection (251Bd); Minnesota and Northeast Iowa Morainal-Oak Savannah Section (222M); Alexandria Moraine-Hardwood Hills Subsection (222Ma) (Cleland et al. 2007).

US EPA Level IV Ecoregion: Tewaukon/Big Stone Stagnation Moraine (46e), Prairie Coteau (46k), Prairie Coteau Escarpment (46l), Big Sioux Basin (46m), Minnesota River Prairie (46o), Des Moines Lobe (47b), Lake Agassiz Plains (48d), Alexandria Moraines and Detroit Lakes Outwash Plain (51j) (USEPA 2013)

### Ecological site concept

The Loamy Floodplain ecological site occurs in high floodplain areas. Soils are moderately well drained which have water flow into and over/through the site and have occasional to frequent flooding. Vegetation in the Reference State is dominated by warm season grasses including big bluestem and switchgrass. Trees may be common on this site, including green ash and bur oak. The site may become invaded by non-native grasses including Kentucky bluegrass and smooth brome grass.

## Associated sites

R102AY002SD	<p><b>Linear Meadow</b></p> <p>These sites occur on lower floodplain area. Soil are poorly to very poorly drained which have a water table within 2 feet of the soil surface that persists longer than the wettest part of the growing season typically until the month of August. The central concept soil series is Castlewood, Lamoure, and Rauville, but other series are included.</p>
-------------	---

## Similar sites

R102AY020SD	<p><b>Loamy Overflow</b></p> <p>The Loamy Overflow site occurs in upland swales. Soils are moderately well drained which have water flow into and over/through the site. The Loamy Overflow site will have less shrubs and trees compared to the Loamy Floodplain site.</p>
-------------	---

**Table 1. Dominant plant species**

Tree	(1) <i>Fraxinus pennsylvanica</i> (2) <i>Populus deltoides subsp. monilifera</i>
Shrub	(1) <i>Symphoricarpos occidentalis</i>
Herbaceous	(1) <i>Andropogon gerardii</i> (2) <i>Panicum virgatum</i>

## Physiographic features

The Loamy Floodplain ecological site occurs in high floodplain areas such as flats, rises and low terraces on floodplains.

**Table 2. Representative physiographic features**

Landforms	(1) Lowland > Flood plain (2)
Runoff class	Negligible to medium
Flooding duration	Very brief (4 to 48 hours) to brief (2 to 7 days)
Flooding frequency	Rare to frequent
Ponding frequency	None
Elevation	298–614 m
Slope	0–2%
Ponding depth	0 cm
Water table depth	81–117 cm
Aspect	Aspect is not a significant factor

## Climatic features

MLRA 102A is considered to have a continental climate – cold winters and relatively hot summers, low to moderate humidity, light rainfall, and much sunshine. Extremes in temperature may also abound. The climate is the result of this MLRA's location near the geographic center of North America. There are few natural barriers on the Northern Great Plains and air masses move freely across the plains and account for rapid changes in temperature.

Annual precipitation typically ranges from 21 to 27 inches per year. The average annual temperature is about 43°F. January is the coldest month with average temperatures ranging from about 5°F (Mahnomen 1 W, Minnesota (MN)), to about 14°F (Tracy, MN). July is the warmest month with temperatures averaging from about 69°F (Mahnomen 1 W, MN), to about 73°F (Tracy, MN). The range of normal average monthly temperatures between the coldest and warmest months is about 62°F. This large annual range attests to the continental nature of this area's

climate. Hourly winds are estimated to average about 11 miles per hour (mph) annually, ranging from about 13 mph during the spring to about 10 mph during the summer. Daytime winds are generally stronger than nighttime and occasional strong storms may bring brief periods of high winds with gusts to more than 50 mph.

Growth of cool-season plants begins in early to mid-March, slowing or ceasing in late June. Warm-season plants begin growth about mid-May and continue to early or mid-September. Greenup of cool-season plants may occur in September and October when adequate soil moisture is present.

**Table 3. Representative climatic features**

Frost-free period (characteristic range)	112-127 days
Freeze-free period (characteristic range)	137-151 days
Precipitation total (characteristic range)	635-711 mm
Frost-free period (actual range)	99-131 days
Freeze-free period (actual range)	130-153 days
Precipitation total (actual range)	610-711 mm
Frost-free period (average)	120 days
Freeze-free period (average)	143 days
Precipitation total (average)	660 mm

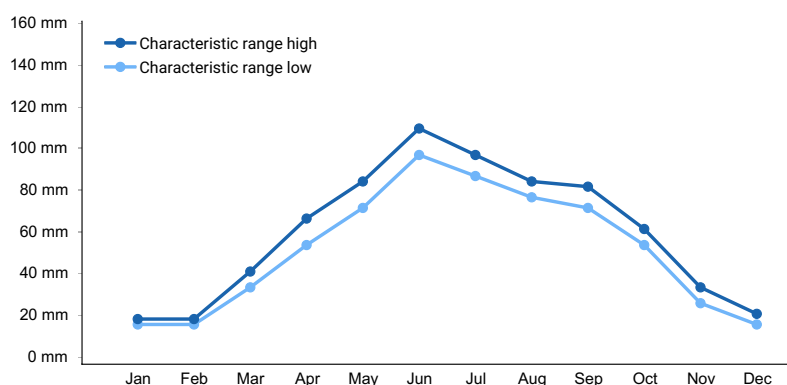

**Figure 1. Monthly precipitation range**

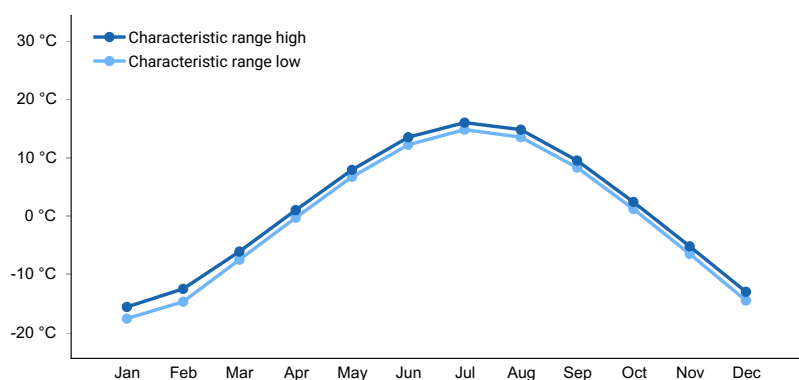

**Figure 2. Monthly minimum temperature range**

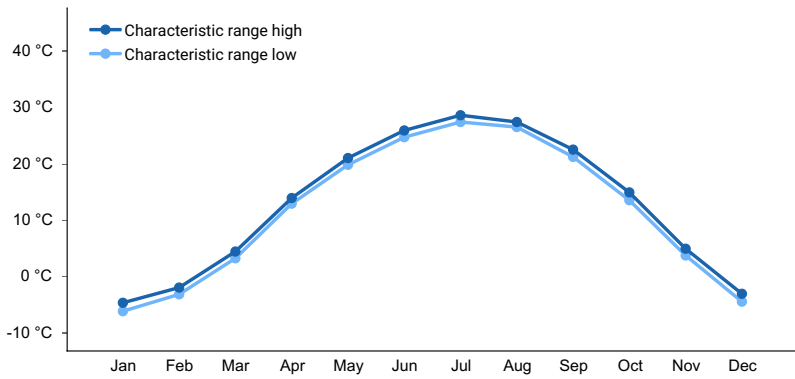

**Figure 3. Monthly maximum temperature range**

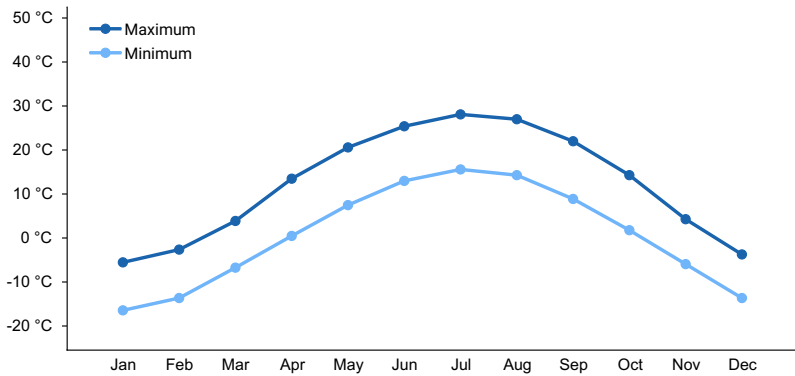

**Figure 4. Monthly average minimum and maximum temperature**

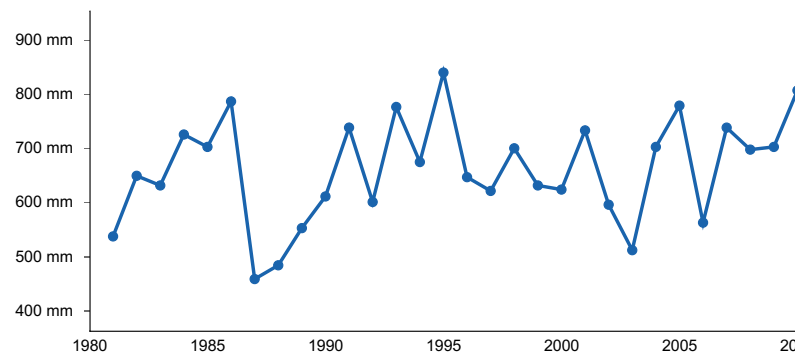

**Figure 5. Annual precipitation pattern**

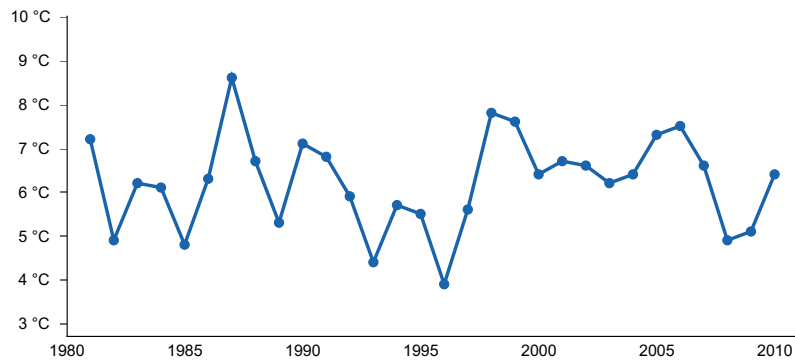

**Figure 6. Annual average temperature pattern**

### Climate stations used

- (1) ARTICHOKE LAKE [USC00210287], Correll, MN
- (2) ARLINGTON 1 W [USC00390281], Arlington, SD
- (3) BENSON [USC00210667], Benson, MN

- (4) BROOKINGS 2 NE [USC00391076], Brookings, SD
- (5) BROWNS VALLEY [USC00211063], Beardsley, MN
- (6) CASTLEWOOD [USC00391519], Castlewood, SD
- (7) CLARK [USC00391739], Clark, SD
- (8) CLEAR LAKE [USC00391777], Clear Lake, SD
- (9) FERGUS FALLS [USC00212768], Fergus Falls, MN
- (10) FOSSTON 1 E [USC00212916], Fosston, MN
- (11) GLENWOOD 2 WNW [USC00213174], Glenwood, MN
- (12) LAKE WILSON [USC00214534], Lake Wilson, MN
- (13) MAHNOMEN [USC00215012], Mahnomen, MN
- (14) MELROSE [USC00215325], Melrose, MN
- (15) MILAN 1 NW [USC00215400], Milan, MN
- (16) MILBANK 4 NW [USC00395536], Milbank, SD
- (17) MORRIS WC EXP STN [USC00215638], Hancock, MN
- (18) PIPESTONE [USC00216565], Pipestone, MN
- (19) ROY LAKE [USC00397326], Lake City, SD
- (20) SISSETON [USC00397742], Sisseton, SD
- (21) SUMMIT 1 W [USC00398116], Summit, SD
- (22) TRACY [USC00218323], Tracy, MN
- (23) TYLER [USC00218429], Tyler, MN
- (24) WATERTOWN 1W [USC00398930], Watertown, SD
- (25) WEBSTER [USC00399004], Webster, SD

### Influencing water features

The Loamy Floodplain ecological site occurs in high floodplain areas. Soils are formed through alluvial processes as water flows into and over/through the site and have occasional to frequent flooding.

### Wetland description

Not Applicable.

### Soil features

The Loamy Floodplain ecological site occurs in high floodplain areas. Soils are moderately well drained which have water flow into and over/through the site and have occasional to frequent flooding. The central concept soil series is LaDelle and La Prairie, but other series are included.

**Table 4. Representative soil features**

Parent material	(1) Alluvium
Surface texture	(1) Silt loam
Drainage class	Moderately well drained
Permeability class	Moderately slow to moderate
Depth to restrictive layer	203 cm
Soil depth	203 cm
Surface fragment cover <=3"	0%
Surface fragment cover >3"	0%
Available water capacity (0-152.4cm)	17.78–22.1 cm
Calcium carbonate equivalent (0-101.6cm)	1–10%
Soil reaction (1:1 water) (0-101.6cm)	6.7–8.3

Subsurface fragment volume <=3" (0-101.6cm)	0-4%
Subsurface fragment volume >3" (0-101.6cm)	0%

## Ecological dynamics

The site which is located in the Prairie Pothole Region developed under Northern Great Plains climatic conditions and included natural influence of large herding herbivores and occasional fire. Changes will occur in the plant communities due to weather fluctuations and/or management actions. Under adverse impacts, a relatively rapid decline in vegetative vigor and composition can occur. Under favorable conditions the site has the potential to resemble the Reference State. Interpretations for this site are based primarily on the 1.1 Big Bluestem-Switchgrass Plant Community Phase. This community phase and the Reference State have been determined by study of rangeland relic areas, areas protected from excessive disturbance, and areas under long-term rotational grazing regimes. Trends in plant community dynamics ranging from heavily grazed to lightly grazed areas, seasonal use pastures, and historical accounts also have been considered.

This ecological site (ES) has been grazed by domestic livestock since they have been introduced into the area. The introduction of domestic livestock and the use of fencing and reliable water sources have changed the ecological dynamics of this site. Continuous grazing without adequate recovery periods following each grazing occurrence over several years, and lack of fire frequency cause this site to depart from the interpretive plant community. Species such as green ash (*Fraxinus pennsylvanica*), and bur oak (*Quercus macrocarpa*) will initially increase. Big bluestem and switchgrass will decrease in frequency and production. Increased woody and tree species and Heavy continuous grazing causes shade tolerant species like Kentucky bluegrass (*Poa pratensis*) to increase and eventually develop into a sod condition. Extended periods of nonuse and no fire will result in a plant community of mature bur oak with a shaded understory of Kentucky bluegrass creating a park like appearance.

Mechanical removal, catastrophic fire, or inundation of woody species will create a community dominated by big bluestem, indiagrass (*Sorghastrum nutans*), and switchgrass which will be invaded with lesser amounts of non-native species such as Kentucky bluegrass and smooth brome (*Bromus inermis*).

Following the state and transition diagram are narratives for each of the described states and community phases. These may not represent every possibility, but they are the most prevalent and repeatable states/community phases. The plant composition tables shown below have been developed from the best available knowledge at the time of this revision. As more data are collected, some of these community phases and/or states may be revised or removed, and new ones may be added. The main purpose for including the descriptions here is to capture the current knowledge and experience at the time of this revision.

## State and transition model

### Loamy Floodplain – MLRA 102A

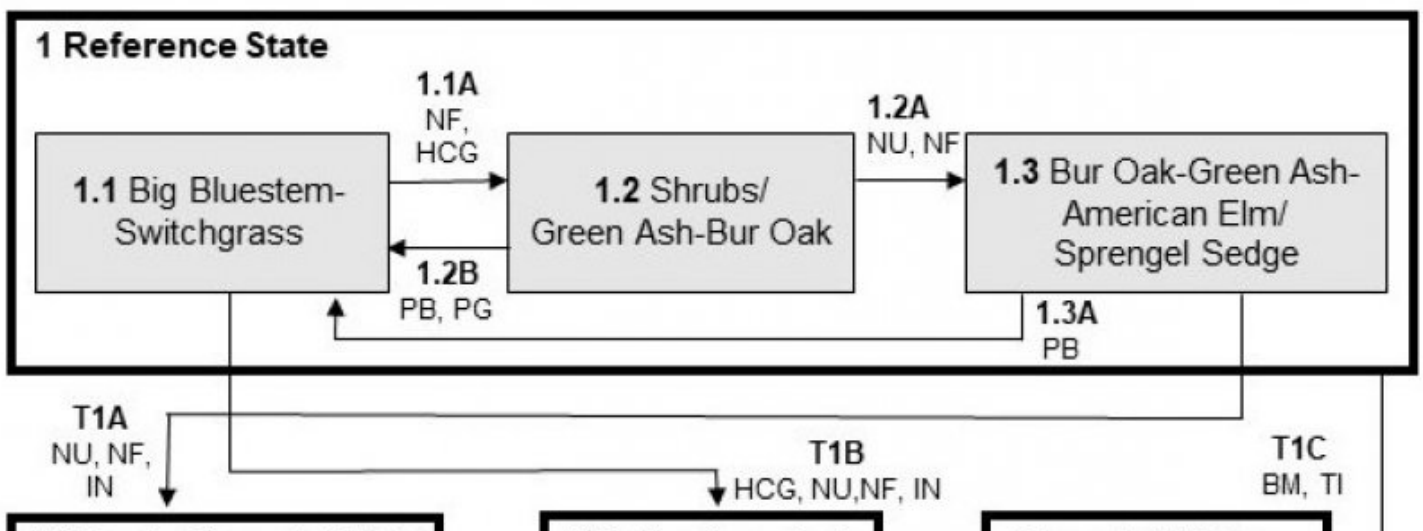

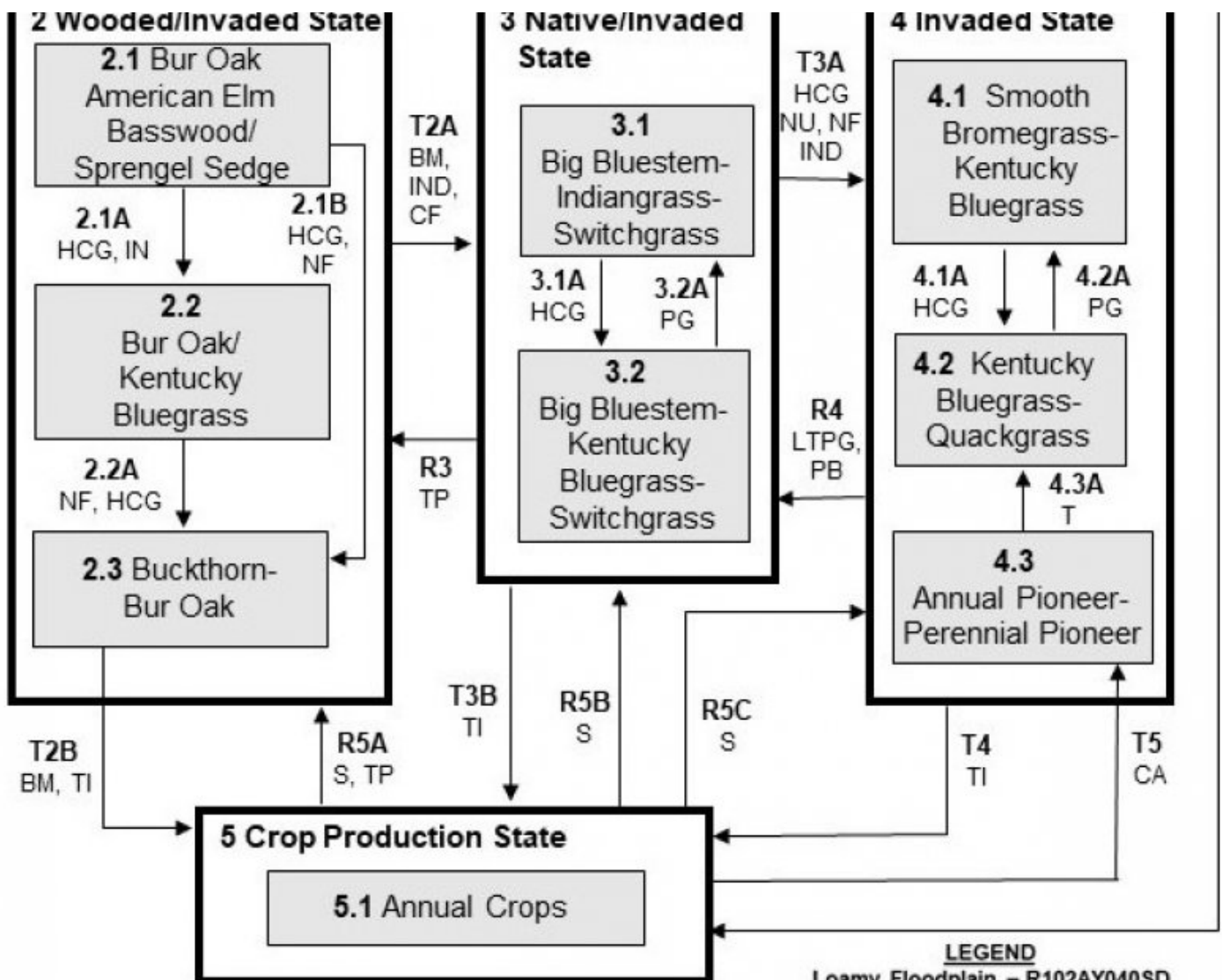

**LEGEND**

Loamy Floodplain – R102AY040SD

- BM – Brush management
- CA – Cropped and abandoned
- CF – Catastrophic fire
- HCG – Heavy continuous grazing
- IN – Invasion
- IND – Inundation
- LTPG – Long-term prescribed grazing
- NU – Non-use
- NF – No fire
- PB – Prescribed burning
- PG – Prescribed grazing
- S – Seeding
- T – Time w/wo disturbances
- TI – Tillage
- TP – Tree planting

Code	Process
T1A	No use, no fire, invasion
T1B	Heavy continuous grazing, no use, no fire, invasion
T1C	Bush management, tillage
T2A	Bush management, inundation, catastrophic fire
T2B	Bush management, tillage
T3A	Heavy continuous grazing, No use, no fire, inundation
T3B	Tillage
T4	Tillage
T5	Abandonment of cropping
1.1A	Heavy continuous grazing, no fire
1.2A	No use, no fire
1.2B	Prescribed grazing with recovery periods, prescribed burning
1.3A	Prescribed burning
2.1A	Heavy continuous grazing, invasion
2.1B	Heavy continuous grazing, no fire
2.2A	Heavy continuous grazing, no fire
3.1A	Heavy continuous grazing
3.2A	Prescribed grazing with recovery periods
4.1A	Heavy continuous grazing
4.2A	Prescribed grazing with recovery periods
4.3A	Time w/wo disturbances
R3	Tree planting
R4	Long term prescribed grazing, prescribed burning
R5A	Seeding, tree planting
R5B	Seeding
R5C	Seeding

## State 1 Reference State

The Reference State would include both community phases 1.1, 1.2 and small areas of 1.3. The extent of each would be dependent upon recent growing conditions. Drought and increased fire frequency would favor the herbaceous community while periods of above normal precipitation and reduced fire frequency would have favored the shrub and woody community phase. Due to change in microclimate within the wooded patches, fire intensity would have been lessened, thereby permitting this community to escape normal fire events. Extreme fire events may have resulted in these areas being burned over and reverting to more of a herbaceous/shrub dominated plant community.

### Dominant plant species

- green ash (*Fraxinus pennsylvanica*), tree
- American elm (*Ulmus americana*), tree
- bur oak (*Quercus macrocarpa*), tree
- big bluestem (*Andropogon gerardii*), grass
- switchgrass (*Panicum virgatum*), grass
- porcupinegrass (*Hesperostipa spartea*), grass
- green needlegrass (*Nassella viridula*), grass
- slender wheatgrass (*Elymus trachycaulus*), grass
- Indiangrass (*Sorghastrum nutans*), grass
- Sprengel's sedge (*Carex sprengei*), grass

## Community 1.1 Big Bluestem-Switchgrass

Interpretations are based primarily on the 1.1 Big Bluestem-Switchgrass Plant Community Phase (this is also considered to be climax). The community was dominated by warm-season grasses. Due to spring flooding events, warm-season species have competitive advantage. The major grasses included big bluestem and switchgrass. Other grass or grass-like species included porcupine grass (*Hesperostipa spartea*), green needlegrass (*Nassella viridula*), slender wheatgrass (*Elymus trachycaulus*), and indiangrass. This plant community was resilient and well



adapted to the Northern Great Plains climatic conditions. The diversity in plant species allowed for high drought tolerance. This was a sustainable plant community in regards to site/soil stability, watershed function, and biologic integrity. This plant community phase is diverse, stable, and productive, and is well adapted to the Northern Great Plains. The high water table supplies much of the moisture for plant growth. Community dynamics, nutrient cycle, water cycle, and energy flow are functioning properly. Plant litter is properly distributed with very little movement off-site and natural plant mortality is very low. The variability of both the fluctuations of water table and reoccurring ponding allows for the diversity in plant species. This is a sustainable plant community in terms of soil stability, watershed function, and biologic integrity.

## **Community 1.2**

### **Shrubs/Green Ash-Bur Oak**

This plant community will slowly develop from the adverse effects of continuous grazing, without adequate recovery periods between each grazing event during the growing season, and/or no surface fire. This phase would occupy those areas which escaped several fire events. When compared to the 1.1 Big Bluestem-Switchgrass Plant Community Phase, native warm season tall grasses have decreased. The woody species, such as shrubs, green ash (*Fraxinus pennsylvanica*), and bur oak (*Quercus macrocarpa*) have increased and tend to dominate this plant community.

## **Community 1.3**

### **Bur Oak-Green Ash-American Elm/Sprengel Sedge**

This plant community will slowly develop from the side effects of non-use and no surface fire. Presence of woody species in the 1.2 Shrubs/Green Ash-Bur Oak Community phase will continue to take over the site when lack of fire and non-use are used in the management practices. Patches of this plant community phase would be found scattered across the site, most likely in slight depressions or other small areas where fire behavior is minimized due to microclimate or terrain. The green ash and bur oak will grow large and begin to shade out other low growing species and close up the canopy.

## **Pathway 1.1A**

### **Community 1.1 to 1.2**

Heavy continuous grazing and/or no fire which includes herbivory at moderate to heavy levels at the same time of year each year without adequate recovery periods, or during periods of below normal precipitation when grazing frequency and intensity increases on these sites due to limited forage availability on adjacent upland sites and no surface fire for extended periods of time (typically for 10 years or more) causing litter levels to become high enough to reduce native grass vigor, diversity, and density will shift this community to the 1.2 Shrubs/Green Ash-Bur Oak Plant Community Phase.

## **Pathway 1.2B**

### **Community 1.2 to 1.1**

Prescribed Grazing, and/or prescribed burning returned to normal disturbance regime levels and frequencies or periodic light to moderate grazing possibly including periodic rest would have converted this plant community to the 1.1 Big Bluestem-Switchgrass Plant Community Phase.

## **Pathway 1.2A**

### **Community 1.2 to 1.3**

Non-use and/or no surface fire for extended periods of time (typically for 10 or more years) causing litter levels to become high enough to reduce native grass vigor, diversity, and density, will likely lead this state over a threshold leading to the 1.3 Bur Oak-Green Ash-American Elm-Sprengel Sedge Plant Community Phase.

## **Pathway 1.3A**

### **Community 1.3 to 1.1**

Prescribed burning returned to normal disturbance regime levels and frequencies to remove woody vegetation

would have converted this plant community to the 1.1 Big Bluestem-Switchgrass Plant Community Phase.

## **State 2**

### **Wooded/Invaded State**

This state is characterized by the increase in bare ground due to trampling caused by excessive use and/or by inundation for extended periods which causes a temporary shift in the plant composition and cover. This allows for the invasion of woody species, which, with continued heavy grazing and no surface fire, can increase to eventual dominance. Loss or reduction of native cool-season and warm-season species can negatively impacted energy flow and nutrient cycling. Herbaceous understory is made up of shade tolerant species such as Sprengel's sedge (*Carex sprengelii*). Small amount of shade tolerant non-native species such as smooth brome grass and Kentucky bluegrass would be present. Infiltration will be reduced and native plant mortality will increase. As the disturbance level increases, native plant density decreases even more, giving way to annual species and invasive perennial species, as well as, a further increase woody species and bare ground.

#### **Dominant plant species**

- bur oak (*Quercus macrocarpa*), tree
- American elm (*Ulmus americana*), tree
- American basswood (*Tilia americana*), tree
- buckthorn (*Frangula*), tree
- Kentucky bluegrass (*Poa pratensis*), grass
- Sprengel's sedge (*Carex sprengelii*), grass

### **Community 2.1**

#### **Bur Oak-American Elm-Basswood/Sprengel Sedge**

This plant community developed with non-use and/or no surface fire for extended periods of time (typically for 10 or more years). bur oak, American elm (*Ulmus Americana*), basswood (*Tilia*), and Sprengel's sedge dominate the community. Kentucky bluegrass, and other non-native species can invade on drier portions of the community. Native warm season tall grasses like big bluestem and switchgrass will be virtually eliminated from the plant community and replaced with woody vegetation and sedges. Areas of bare ground can be present throughout the site.

### **Community 2.2**

#### **Bur Oak/Kentucky Bluegrass**

This plant community developed with heavy continuous grazing without adequate recovery periods between grazing events and no surface fire. The dominant vegetation includes mature oak trees, native and non-native shade tolerant grasses, and shrubs. Grasses may include, fowl bluegrass (*Poa palustris*), Kentucky bluegrass, and sedges. This is due to the loss of diversity (including the loss of the seed bank) within the existing plant community and the plant communities on adjacent sites, and increased shade from mature oak trees shading out native species. Significant economic inputs, management, and time would be required to move this plant community toward a higher successional stage. Secondary succession is highly variable, depending upon availability and diversity of a viable reproductive source of higher successional species.

### **Community 2.3**

#### **Buckthorn-Bur Oak**

This plant community phase is characterized by a dense understory of buckthorn with an overstory of mature oak and scattered green ash. Little or no regeneration of native woody species is occurring due to competition from buckthorn. As mature trees die, they are replaced by buckthorn. If present, the herbaceous understory consists of Kentucky bluegrass and possibly Sprengel's sedge. Eastern red cedar will probably eventually replace the buckthorn due to its shade tolerance, it will germinate in the understory of the buckthorn. Significant economic inputs, management, and time would be required to move this plant community toward a higher successional stage. Secondary succession is highly variable, depending upon availability and diversity of a viable reproductive source of higher successional species.

## **Pathway 2.1A**

### **Community 2.1 to 2.2**

Heavy continuous grazing which includes herbivory at moderate to heavy levels at the same time of year each year without adequate recovery periods, or during periods of below normal precipitation when grazing frequency and intensity increases on these sites due to limited forage availability on adjacent upland sites and/or invasion of non-native plant species will shift this community to the 2.2 Bur Oak/Kentucky Bluegrass Plant Community Phase.

## **Pathway 2.1B**

### **Community 2.1 to 2.3**

Heavy continuous grazing and/or no fire will encourage invasion by buckthorn and/or Eastern red cedar, Kentucky bluegrass, smooth brome. These invasive species alter regeneration rates of native species by out-competing them for resources. As Eastern red cedar amounts increase, the potential for catastrophic fire increases due to the volatile nature of Eastern red cedar. Heavy continuous grazing which includes herbivory at moderate to heavy levels at the same time of year each year without adequate recovery periods, or during periods of below normal precipitation when grazing frequency and intensity increases on these sites due to limited forage availability on adjacent upland sites and/ or no surface fire for extended periods of time (typically for 10 years or more) causing litter levels to become high enough to reduce native grass vigor, diversity, and density will shift this community to the 2.3 Buckthorn-Bur Oak Plant Community Phase.

## **Pathway 2.2A**

### **Community 2.2 to 2.3**

Heavy continuous grazing and/or no fire will encourage invasion by buckthorn and/or Eastern red cedar, Kentucky bluegrass, smooth brome. These invasive species alter regeneration rates of native species by out-competing them for resources. As Eastern red cedar amounts increase, the potential for catastrophic fire increases due to the volatile nature of Eastern red cedar. Heavy continuous grazing which includes herbivory at moderate to heavy levels at the same time of year each year without adequate recovery periods, or during periods of below normal precipitation when grazing frequency and intensity increases on these sites due to limited forage availability on adjacent upland sites and/or no surface fire for extended periods of time (typically for 10 years or more) causing litter levels to become high enough to reduce native grass vigor, diversity, and density will shift this community to the 2.3 Buckthorn-Bur Oak Plant Community Phase.

## **State 3**

### **Native/Invaded State**

This state represents the more common range of variability that exists with higher levels of grazing management but in the absence of periodic fire due to fire suppression. This state is dominated by warm-season grasses, with cool-season grasses being subdominant. It can be found on areas that are properly managed with grazing and/or prescribed burning, and sometimes on areas receiving occasional short periods of rest. Taller warm-season species can decline and a corresponding increase in short statured grass will occur.

#### **Dominant plant species**

- big bluestem (*Andropogon gerardii*), grass
- switchgrass (*Panicum virgatum*), grass
- Indiangrass (*Sorghastrum nutans*), grass
- Kentucky bluegrass (*Poa pratensis*), grass
- smooth brome (*Bromus inermis*), grass
- porcupinegrass (*Hesperostipa spartea*), grass
- green needlegrass (*Nassella viridula*), grass
- slender wheatgrass (*Elymus trachycaulus*), grass

## **Community 3.1**

### **Big Bluestem-Indiangrass-Switchgrass**

This plant community phase is similar to the 1.1 Big Bluestem-Switchgrass Plant Community Phase but it also

contains minor amounts of non-native invasive grass species such as Kentucky bluegrass and smooth brome grass (up to about 10 percent by air-dry weight). The potential vegetation is about 80 percent grasses or grass-like plants, 10 percent forbs, and 10 percent shrubs. This community is dominated by warm-season grasses. The major grasses include big bluestem and switchgrass. Other grass or grass-like species include porcupine grass, green needlegrass, Indiangrass, and slender wheatgrass. This plant community is resilient and well adapted to the Northern Great Plains climatic conditions. The diversity in plant species allows for high drought tolerance. This is a sustainable plant community in regards to site/soil stability, watershed function, and biologic integrity.

## **Community 3.2**

### **Big Bluestem-Kentucky Bluegrass-Switchgrass**

This plant community is a result of heavy continuous grazing or from over utilization during extended drought periods. The potential plant community is made up of approximately 75 percent grasses and grass-like species, 15 percent forbs, and 10 percent shrubs. Dominant grasses include big bluestem, Kentucky bluegrass, and switchgrass. Grasses of secondary importance include Indiangrass, smooth brome grass, sideoats grama, green needlegrass, tall dropseed, slender wheatgrass, and sedge. Forbs commonly found in this plant community include white sagebrush (locally known as cudweed sagewort) (*Artemisia ludoviciana*), white heath aster (*Symphotrichum ericoides*), Canada goldenrod (*Solidago canadensis*), stiff goldenrod (*Solidago rigida*), scurfpea (*Psoraleum*), Indian hemp (*Apocynum cannabinum*), and common yarrow (*Achillea millefolium*). When compared to the 1.1 Big Bluestem-Switchgrass Plant Community Phase, big bluestem has increased and Kentucky bluegrass has invaded and become a codominant. Production of tall warm-season grasses is reduced. This plant community is moderately resistant to change. The herbaceous species present are well adapted to grazing; however, species composition can be altered through long-term overgrazing. If the herbaceous component is intact, it tends to be resilient if the disturbance is not long-term. Most of the components of the ecological processes are functioning at optimum levels. However, the vigor and reproductive capability of the tall warm-season grasses are reduced due to grazing pressure or a combination of stressors. A reduction of this dominant functional group allows for an increase in shorter-statured (and shallower rooted) species. The introduction of nonnative invasive species such as Kentucky bluegrass and smooth brome grass results in alterations to the soil profile. Organic matter levels tend to decrease and begin to be concentrated more in the surface layers and the structure will begin to be modified. These changes favor the shallow-rooted species and hasten their eventual dominance if steps are not taken to reduce these species.

## **Pathway 3.1A**

### **Community 3.1 to 3.2**

Heavy continuous grazing which includes herbivory at moderate to heavy levels at the same time of year each year without adequate recovery periods, or during periods of below normal precipitation when grazing frequency and intensity increases on these sites due to limited forage availability on adjacent upland sites will shift this community to the 3.2 Big Bluestem-Kentucky Bluegrass-Switchgrass Plant Community Phase.

## **Pathway 3.2A**

### **Community 3.2 to 3.1**

Prescribed grazing (alternating season of use and providing adequate recovery periods) or periodic light to moderate grazing possibly including periodic rest will convert this plant community to the 3.1 Big Bluestem-Indiangrass-Switchgrass Plant Community Phase.

## **State 4**

### **Invaded State**

This state is a result of encroachment mainly by invasive introduced cool-season grasses. The ecological processes are not functioning, especially the biotic processes and the hydrologic functions. The introduced cool-season grasses cause reduced infiltration and increased runoff. Preliminary studies would tend to indicate this threshold may exist when Kentucky bluegrass exceeds 30 percent of the plant community and native grasses represent less than 40 percent of the plant community composition. The opportunity for high intensity spring burns is severely reduced by early greenup and increased moisture and humidity at the soil surface and grazing pressure cannot cause a reduction in sodgrass dominance. Production is limited to the sod forming species. Infiltration continues to decrease and runoff increases and energy capture into the system is restricted to early season low producing

species. Nutrient cycling is limited by root depth of the dominant species.

### **Dominant plant species**

- Kentucky bluegrass (*Poa pratensis*), grass
- smooth brome (*Bromus inermis*), grass
- quackgrass (*Elymus repens*), grass

## **Community 4.1**

### **Smooth Bromegrass-Kentucky Bluegrass**

This plant community phase is a result of extended periods of nonuse and no fire or occasionally light levels of grazing over several years. It is characterized by dominance of smooth bromegrass and to a lesser extent Kentucky bluegrass. The dominance is at times so complete that other species are difficult to find on the site. A thick duff layer also accumulates at or above the soil surface and eventually a thatch-mat layer may develop. Nutrient cycling is greatly reduced and native plants have great difficulty becoming established. When dominated by smooth bromegrass, infiltration is moderately reduced and runoff is moderate. Production can be equal to or higher than the interpretive plant community. However, when dominated by Kentucky bluegrass, infiltration is greatly reduced and runoff is high. Production in this case will likely be significantly less. In either case, the period that palatability is high is relatively short as these cool-season species mature rapidly. Energy capture is also reduced. The dominance of these introduced species has been shown to alter the biotic component of the soil, as well as, organic matter levels and eventually the soil structure. These alterations perpetuate the dominance of Kentucky bluegrass and smooth bromegrass and tend to make establishment of native species extremely difficult.

## **Community 4.2**

### **Kentucky Bluegrass-Quackgrass**

This plant community phase is a result of heavy, continuous seasonal grazing or heavy, continuous season-long grazing. It is characterized by a dominance of Kentucky bluegrass and quackgrass. The dominance is at times so complete that other species are difficult to find on the site. A relatively thick duff layer can sometimes accumulate at or above the soil surface and eventually a thatch-mat layer may develop at the surface as well. Nutrient cycling is greatly reduced and native plants have great difficulty becoming established. Infiltration is greatly reduced and runoff is high. Production will be significantly reduced when compared to the interpretive plant community. The period that palatability is high is relatively short as Kentucky bluegrass matures rapidly. Energy capture is also reduced. Biological activity in the soil is likely reduced significantly in this phase.

## **Community 4.3**

### **Annual Pioneer-Perennial Pioneer**

This plant community developed under continuous heavy grazing or other excessive disturbances. The potential plant community is made up of approximately 40 to 80 percent grasses and grass-like species, 20 to 60 percent forbs, and 0 to 5 percent shrubs. The species present in this phase are highly variable but often include non-native invasive and/or early seral species. Plant diversity is low (plant richness may be high, but areas are often dominated by a few species). The ecological processes are difficult to restore because of the loss of plant diversity and overall soil disturbance. Soil erosion is potentially very high because of the bare ground and shallow rooted herbaceous plant community. Water runoff will increase and infiltration will decrease due to animal related soil compaction and loss of root mass due to low plant diversity and vigor. This plant community will require significant economic inputs and time to move towards another plant community. This movement is highly variable in its succession. This is due to the loss of diversity (including the loss of the seed bank), within the existing plant community, and the plant communities on adjacent sites. This community can be renovated to improve the production capability; however, if management changes are not made the vegetation could revert back to early seral species.

## **Pathway 4.1A**

### **Community 4.1 to 4.2**

Heavy continuous grazing which includes herbivory at moderate to heavy levels at the same time of year each year without adequate recovery periods, or during periods of below normal precipitation when grazing frequency and intensity increases on these sites due to limited forage availability on adjacent upland sites will shift this community

to the 4.2 Kentucky Bluegrass-Quackgrass Plant Community Phase.

### **Pathway 4.2A** **Community 4.2 to 4.1**

Prescribed grazing (alternating season of use and providing adequate recovery periods) or periodic light to moderate grazing possibly including periodic rest will convert this plant community to the 4.1 Smooth Bromegrass-Kentucky Bluegrass Plant Community Phase.

### **Pathway 4.3A** **Community 4.3 to 4.2**

This community pathway occurs with the passage of time as successional processes take place and perennial plants gradually begin to establish on the site again. This pathway will lead to the 4.2 Kentucky Bluegrass-Quackgrass Plant Community Phase.

## **State 5** **Crop Production State**

This state is characterized by the production of annual crops using a variety of tillage and cropping systems along with management practices. Cropping on this site is enabled during years with drier than normal precipitation or with artificial drainage (surface or subsurface).

### **Dominant plant species**

- corn (*Zea mays*), grass
- common wheat (*Triticum aestivum*), grass
- soybean (*Glycine max*), other herbaceous

## **Community 5.1** **Annual Crops**

This plant community developed with the use of a variety of tillage systems and cropping systems for the production of annual crops including corn, soybeans, wheat, sugar beet and a variety of other crops.

## **Transition T1A** **State 1 to 2**

Non-use and/or no surface fire for extended periods of time (typically for 10 or more years) causing litter levels to become high enough to reduce native grass vigor, diversity, and density, and density or invasion of non-native plant species will likely lead this 1.3 Bur Oak-Green Ash-American Elm/Sprengel Sedge Plant Community Phase within the Reference State (State 1) over a threshold leading the Wooded/Invaded State (State 2).

## **Transition T1B** **State 1 to 3**

Non-use and/or no surface fire for extended periods of time (typically for 10 or more years) causing litter levels to become high enough to reduce native grass vigor, diversity, and density, and/or heavy continuous grazing or invasion of non-native plant species will likely lead this 1.1 Big Bluestem-Switchgrass Plant Community Phase within the Reference State (State 1) state over a threshold resulting in the Native/Invaded State (State 3).

## **Transition T1C** **State 1 to 5**

Brush management such as removing woody vegetation and tillage will cause a shift over a threshold leading to the 5.1 Annual Crops Plant Community Phase within the Crop Production State (State 5).

## **Transition T2A**

### **State 2 to 3**

Brush management such as removing woody vegetation, catastrophic fire which burns with high intensity to kill a majority of the trees in the canopy, and/or inundation due to flooding with very long duration (greater than 30 days) beyond normal ponding and drying patterns will cause a shift over a threshold leading to the Native/Invaded State (State 3).

## **Transition T2B**

### **State 2 to 5**

Brush management such as removing woody vegetation and tillage will cause a shift over a threshold leading to the 5.1 Annual Crops within the Crop Production State (State 5).

## **Restoration pathway R3**

### **State 3 to 2**

Tree Planting will likely lead this state over a threshold leading to the Wooded/Invaded State (State 2). This will take significant resources and years of monitoring and management.

## **Transition T3A**

### **State 3 to 4**

Non-use and/or no surface fire for extended periods of time (typically for 10 or more years) causing litter levels to become high enough to reduce native grass vigor, diversity, and density, Heavy continuous grazing (stocking levels well above carrying capacity for extended portions of the growing season and often at the same time of year each year), and/or Inundation due to flooding with very long duration (greater than 30 days) beyond normal ponding and drying patterns will likely lead this state over a threshold leading to the Invaded State (State 4).

## **Transition T3B**

### **State 3 to 5**

Tillage will cause a shift over a threshold leading to the 5.1 Annual Crops within the Crop Production State (State 5).

## **Restoration pathway R4**

### **State 4 to 3**

Long-term prescribed grazing (moderate stocking levels coupled with adequate recovery periods, or other grazing systems such as high-density, low-frequency intended to treat specific species dominance, or periodic light to moderate stocking levels possibly including periodic rest) coupled with prescribed burning may lead this plant community phase over a threshold to the Native/Invaded State (State 3).

## **Transition T4**

### **State 4 to 5**

Tillage will cause a shift over a threshold leading to the 5.1 Annual Crops Community Phase within the Crop Production State (State 5).

## **Restoration pathway R5A**

### **State 5 to 2**

Seeding combined with Tree Planting may lead this Crop Production State (State 5) over a threshold leading to the Wooded/Invaded State (State 2). This will take significant resources and years of monitoring and management.

## **Restoration pathway R5B**

### **State 5 to 3**

Seeding may lead this Crop Production State (State 5) over a threshold leading to the Native/Invaded State (State 3).

## **Restoration pathway R5C State 5 to 4**

Seeding may lead this Crop Production State (State 5) over a threshold to the Invaded State (State 4) Cropping followed by abandonment may lead this plant community phase over a threshold to the Invaded State (State 4) and more specifically to the 4.3 Annual Pioneer-Perennial Pioneer Plant Community Phase.

## **Additional community tables**

### **Inventory data references**

There is no NRCS clipping data and other inventory currently available for this site. Information presented here has been derived using field observations from range-trained personnel. Those involved in developing this site include: Stan Boltz, Range Management Specialist, NRCS.

### **Other references**

Cleland, D.T., J.A. Freeouf, J.E. Keys, G.J. Nowacki, C. Carpenter, and W.H. McNab. 2007. Ecological Subregions: Sections and Subsections of the Conterminous United States. USDA Forest Service, General Technical Report WO-76. Washington, DC. 92 pps.

Gilbert, M. C., Whited, P. M., Clairain Jr, E. J., & Smith, R. D. (2006). A Regional Guidebook for Applying the Hydrogeomorphic Approach to Assessing Wetland Functions of Prairie Potholes. Washington DC.

High Plains Regional Climate Center, University of Nebraska, 830728 Chase Hall, Lincoln, NE 68583-0728. (<http://www.hprcc.unl.edu/>)

Meehan et al (2011) Riparian Ecosystems of the Middle Sheyenne River in Eastern North Dakota. Fargo, North Dakota. NDSU Dept of Ag and Applied Science Graduate Program.

Samson, F. B., & Knopf, F. L. (1996). Prairie Conservation Preserving North America's Most Endangered Ecosystem. Washington D.C.: Island Press.

Soil Survey Staff, Natural Resources Conservation Service, United States Department of Agriculture. Official Soil Series Descriptions. Available online. Accessed March 2018.

United States Department of Agriculture – Natural Resource Conservation Service (USDA-NRCS). 2003. National Range and Pasture Handbook, Revision 1. Grazing Lands Technology Institute. 214 pps.

United States Department of Agriculture – Natural Resource Conservation Service (USDA-NRCS). 2006. Land Resource Regions and Major Land Resource Areas of the United States, the Caribbean, and the Pacific Basin. U.S. Department of Agriculture Handbook 296. 672pps.

USDA, NRCS. National Soil Information System, Information Technology Center, 2150 Centre Avenue, Building A, Fort Collins, CO 80526. (<http://soils.usda.gov/technical/nasis/>)

USDA, NRCS. National Water and Climate Center, 101 SW Main, Suite 1600, Portland, OR 97204-3224. (<http://www.wcc.nrcs.usda.gov>)

USDA, NRCS. 2018. The PLANTS Database (<http://plants.usda.gov>, 27 March 2018). National Plant Data Team, Greensboro, NC 27401-4901 USA.

USDA, NRCS. National Range and Pasture Handbook, September 1997



U.S. Environmental Protection Agency [EPA]. 2013. Level III and Level IV Ecoregions of the Continental United States. Corvallis, OR, U.S. EPA, National Health and Environmental Effects Research Laboratory, map scale 1:3,000,000. Available at <http://www.epa.gov/eco-research/level-iii-and-iv-ecoregions-continental-united-states>. (Accessed 1 March 2018).

## Contributors

Lance Howe  
Steve Winter

## Approval

Suzanne Mayne-Kinney, 8/20/2024

## Acknowledgments

Contact for Lead Authors: Natural Resources Conservation Service (USDA-NRCS), Redfield Soil Survey Office Redfield, SD; Lance Howe (Lance.Howe@usda.gov), Soil Survey Office Leader, USDA-NRCS, Redfield, SD; and Steve Winter (Steven.Winter@usda.gov), Soil Scientist, USDA-NRCS, Redfield, SD

Additional Information Acknowledgment: Jason Hermann (Jason.Hermann@usda.gov), Area Rangeland Management Specialist, USDA-NRCS, Redfield, SD; Jenita Qualm (Jenita.Qualm@usda.gov), Acting State Rangeland Management Specialist, USDA-NRCS, Pierre, SD.

## Rangeland health reference sheet

Interpreting Indicators of Rangeland Health is a qualitative assessment protocol used to determine ecosystem condition based on benchmark characteristics described in the Reference Sheet. A suite of 17 (or more) indicators are typically considered in an assessment. The ecological site(s) representative of an assessment location must be known prior to applying the protocol and must be verified based on soils and climate. Current plant community cannot be used to identify the ecological site.

Author(s)/participant(s)	
Contact for lead author	
Date	08/20/2024
Approved by	Suzanne Mayne-Kinney
Approval date	
Composition (Indicators 10 and 12) based on	Annual Production

## Indicators

1. **Number and extent of rills:**

---

2. **Presence of water flow patterns:**

---

3. **Number and height of erosional pedestals or terracettes:**

---

4. **Bare ground from Ecological Site Description or other studies (rock, litter, lichen, moss, plant canopy are not bare ground):**

---

5. **Number of gullies and erosion associated with gullies:**

---

6. **Extent of wind scoured, blowouts and/or depositional areas:**

---

7. **Amount of litter movement (describe size and distance expected to travel):**

---

8. **Soil surface (top few mm) resistance to erosion (stability values are averages - most sites will show a range of values):**

---

9. **Soil surface structure and SOM content (include type of structure and A-horizon color and thickness):**

---

10. **Effect of community phase composition (relative proportion of different functional groups) and spatial distribution on infiltration and runoff:**

---

11. **Presence and thickness of compaction layer (usually none; describe soil profile features which may be mistaken for compaction on this site):**

---

12. **Functional/Structural Groups (list in order of descending dominance by above-ground annual-production or live foliar cover using symbols: >>, >, = to indicate much greater than, greater than, and equal to):**

Dominant:

Sub-dominant:

Other:

Additional:

---

13. **Amount of plant mortality and decadence (include which functional groups are expected to show mortality or decadence):**

---

14. **Average percent litter cover (%) and depth ( in):**

---

15. **Expected annual annual-production (this is TOTAL above-ground annual-production, not just forage annual-production):**

---

16. **Potential invasive (including noxious) species (native and non-native).** List species which **BOTH** characterize degraded states and have the potential to become a dominant or co-dominant species on the ecological site if their future establishment and growth is not actively controlled by management interventions. Species that become dominant for only one to several years (e.g., short-term response to drought or wildfire) are not invasive plants. Note that unlike other indicators, we are describing what is **NOT** expected in the reference state for the ecological site:
- 

17. **Perennial plant reproductive capability:**
-