

Ecological site R102CY060NE SHALLOW CLAY

Last updated: 10/03/2024
Accessed: 11/21/2024

General information

Provisional. A provisional ecological site description has undergone quality control and quality assurance review. It contains a working state and transition model and enough information to identify the ecological site.

MLRA notes

Major Land Resource Area (MLRA): 102C—Loess Uplands

Most of this area is in the Dissected Till Plains part of the Central Lowland Province of the Interior Plains. This MLRA has broad, undulating to rolling ridgetops and hilly to steep valley sides. The valleys are generally narrow, but broad flood plains and terraces are along the major rivers and the large tributaries. Elevation ranges from 335 to 610 meters (1,100 to 2,000 feet) increasing from southeast to northwest. Peorian age loess covers most of the area with depths ranging from 2 to 20 meters (6 to 70 feet). Glacial till underlies the loess in most areas. Bedrock can be found at or near the surface predominantly along the Missouri River valley found on the eastern side of the MLRA, but some bedrock can also be found in the northern part of 102C in Minnesota and South Dakota. The soils are predominantly Mollisols but Entisols are prominent in the floodplains of the area. Nearly all the area is farmed with 70% of the area being used as cropland for corn and soybeans. Feed grains and hay crops are also grown. The major resource concerns are wind erosion, water erosion, maintenance of organic matter and soil tilth, and soil moisture management. (USDA/NRCS 2006)

Classification relationships

NE Natural Heritage Program/NE Game & Parks Commission: "Lowland Tallgrass Prairie"

General information for MLRA 102C:

Fenneman (1916) Physiographic Regions

Division - Interior Plains

East:

Province - Central Lowland

Section - Till Plains

West:

Province - Great Plains

Section - High Plains

USFS (2007) Ecoregions

Domain - Humid Temperate

Division - Prairie

Province - Prairie Parkland (Temperate)

Section - North-Central Glaciated Plains (251B)

EPA Ecoregions (Omernik 1997)

I - Great Plains (9)

II - Temperate Prairies (9.2)

III - Western Corn Belt Plains (9.2.3) IV - Loess Prairies (47a)

Ecological site concept

This upland ecological site has shallow clayey soils and a reference community dominated by warm season grasses. The foremost diagnostic feature of this site is the high clay content that begins at or near the surface and the shallow depth to bedrock (20inches). The site does not receive additional moisture from higher adjacent areas and is subject to significant runoff. This site predominantly occurs on slightly to steeply sloping upland positions (10 - 30% slopes). Water typically runs off these sites to adjacent overflow or upland sites. It has a seasonally high-water table that is below 180 centimeters (71 inches) year around. The site does not pond and does not flood. These are shallow, well drained soils that formed in clayey residuum. The surface texture is predominantly clay from 5 to 15 centimeters (2 to 6 inches) and the Subsurface Texture Groups are clayey from 10 to 38 centimeters (4 to 20 inches). The plant community consists of 80-95% grasses and grass-like, 5-10% forbs and 0-5% shrubs. Dominant grasses include Big bluestem, Little bluestem, Indiangrass, Switchgrass, and Tall dropseed. Other grasses and grass-like are Canada wildrye, Kentucky bluegrass, Prairie junegrass, Sideoats grama, Scribner panicum, forbs and sedges.

Associated sites

R102CY058NE	Loamy Upland Occurs on uplands and other run-off landscapes with silty and loamy textures throughout
R102CY050NE	Loamy Lowland Occurs on terraces and floodplains with rare flooding frequency or less

Similar sites

R102CY057NE	CLAYEY Shares the clayey textures of this PESD but the soil depth is deep since it has no restrictive layer.
R102CY061NE	SHALLOW LIMY Bedrock or other root restrictive layer between 10 and 20 inches. Layers above the restrictive layer are strongly or violently effervescent with CaCO ₃ increasing with depth.

Table 1. Dominant plant species

Tree	Not specified
Shrub	Not specified
Herbaceous	(1) <i>Andropogon gerardii</i> (2) <i>Schizachyrium scoparium</i>

Physiographic features

This site predominantly occurs on slightly to steeply sloping upland positions (10 - 30% slopes). Water typically runs off these sites to adjacent overflow or upland sites. It has a seasonally high-water table that is below 180 centimeters (71 inches) year around. The site does not pond and does not flood.

Table 2. Representative physiographic features

Landforms	(1) Upland slope
Runoff class	Very high
Elevation	343–378 m
Slope	10–30%
Water table depth	180 cm
Aspect	Aspect is not a significant factor

Climatic features

Most of the rainfall occurs as high-intensity, convective thunderstorms during the growing season. The maximum precipitation occurs from the middle of spring to early in autumn. Precipitation in winter occurs as snow. The annual snowfall ranges from about 60 centimeters (24 inches) in the southern part of the area to 85 centimeters (34 inches) in the northern part. The average annual temperature gradient trends higher from north (7°C / 45°F) to south (11°C / 51°F), and the average annual precipitation gradient trends higher from northwest (64 centimeters / 25 inches) to southeast (79 centimeters / 31 inches).

The following data summary includes weather stations representing the full geographic extent of the MLRA and is based on 70% probabilities. This means that actual observed climate conditions may fall outside these ranges 30% of the time. Furthermore, climatic events can manifest many ways. For example, abnormally dry periods could occur as 3 consecutive drought years out of 10, 3 individual years separated by “normal” years, or some combination. Tree-ring records indicate that portions of the Great Plains have also historically experienced droughts lasting several decades, so plant community response will largely depend on the way climatic variability is realized in interaction with past and current land management.

Table 3. Representative climatic features

Frost-free period (characteristic range)	123-129 days
Freeze-free period (characteristic range)	144-154 days
Precipitation total (characteristic range)	686-762 mm
Frost-free period (actual range)	122-135 days
Freeze-free period (actual range)	141-165 days
Precipitation total (actual range)	686-762 mm
Frost-free period (average)	128 days
Freeze-free period (average)	150 days
Precipitation total (average)	737 mm

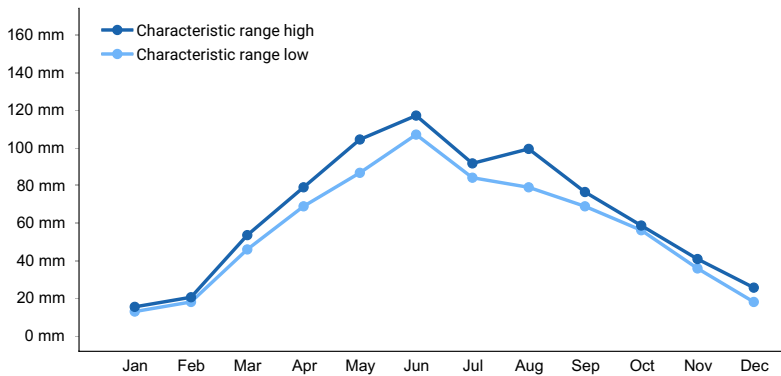

Figure 1. Monthly precipitation range

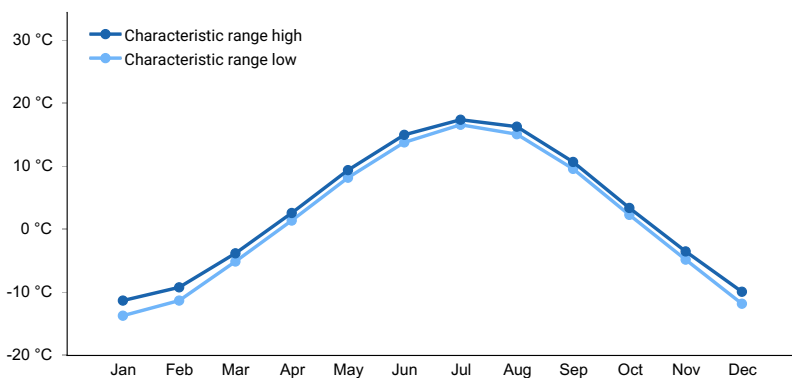

Figure 2. Monthly minimum temperature range

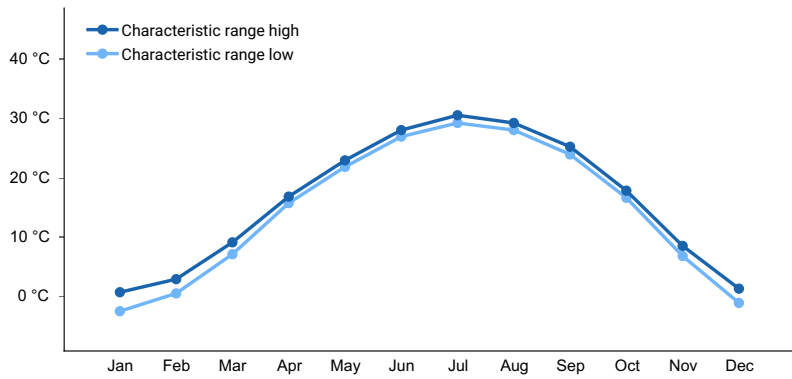

Figure 3. Monthly maximum temperature range

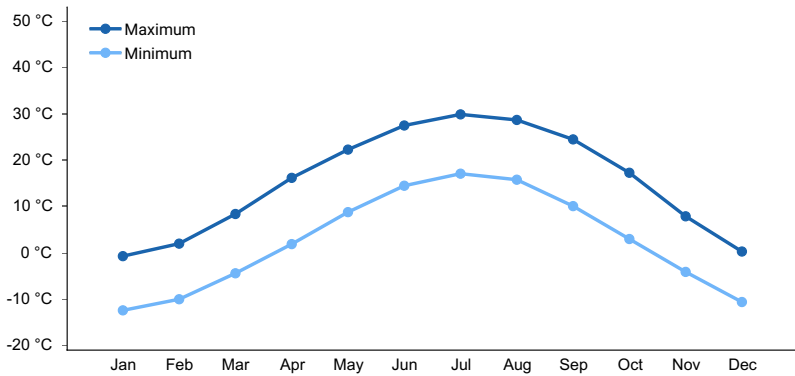

Figure 4. Monthly average minimum and maximum temperature

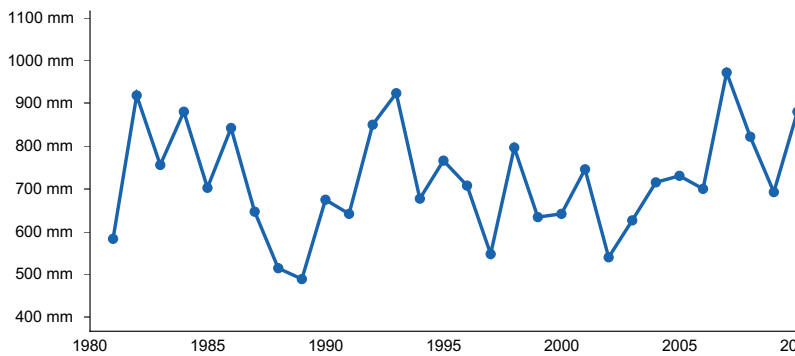

Figure 5. Annual precipitation pattern

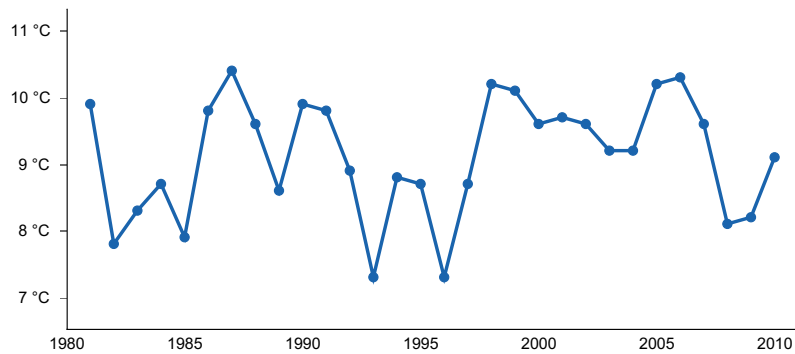

Figure 6. Annual average temperature pattern

Climate stations used

- (1) HAWARDEN [USC00133718], Hawarden, IA
- (2) LUVERNE [USC00214937], Luverne, MN
- (3) WALTHILL 1E [USC00258935], Walthill, NE

- (4) YANKTON 2 E [USW00094911], Yankton, SD
- (5) FLANDREAU [USC00392984], Flandreau, SD
- (6) WAYNE [USC00259045], Wayne, NE
- (7) NORFOLK 4W [USC00255997], Norfolk, NE
- (8) GENOA 2 W [USC00253185], Genoa, NE
- (9) ASHLAND NO 2 [USC00250375], Ashland, NE
- (10) ELGIN [USC00252595], Elgin, NE

Influencing water features

No riparian or wetland features are associated with this site.

Soil features

These are shallow, well drained soils that formed in clayey residuum. The surface texture is predominantly clay from 5 to 15 centimeters (2 to 6 inches) and the Subsurface Texture Groups are clayey from 10 to 38 centimeters (4 to 20 inches).

Rills, gullies, and water flow patterns are not inherent to this site. Pedestalling is none to slight. Soil aggregate stability should be high due to the high clay amounts.

Major soils assigned to this site include: Sansarc

Table 4. Representative soil features

Parent material	(1) Residuum
Surface texture	(1) Clay (2) Silty clay
Drainage class	Well drained
Depth to restrictive layer	20–38 cm
Soil depth	0–51 cm
Surface fragment cover ≤3"	0–50%
Surface fragment cover >3"	0–1%
Available water capacity (Depth not specified)	2.54–5.08 cm
Calcium carbonate equivalent (Depth not specified)	0–10%
Electrical conductivity (Depth not specified)	0–2 mmhos/cm
Sodium adsorption ratio (Depth not specified)	0–1
Soil reaction (1:1 water) (Depth not specified)	6.6–8.4
Subsurface fragment volume ≤3" (Depth not specified)	0–60%
Subsurface fragment volume >3" (Depth not specified)	0–1%

Ecological dynamics

The foremost diagnostic feature of this site is the high clay content that begins at or near the surface and the shallow depth to bedrock (20 to 38 centimeters / 8 to 15 inches). The site does not receive additional moisture from higher adjacent areas and is subject to significant runoff. Relatively minor changes in local elevation can affect the plant community since the bedrock can fluctuate in depth. This site often occurs in complex with the Loamy

Lowland and Loamy Upland sites.

This site developed with occasional fires being part of the ecological processes. It is presumed that the historic fires generally occurred every 3-4 years, were randomly distributed, and started by lightning at various times throughout the season when thunderstorms were likely to occur. It is also believed that pre-European inhabitants may have used fire as a management tool for attracting herds of large migratory herbivores (bison, elk, and/or deer.) The impact of fire over the past 100 years has been relatively insignificant due to the human control of wildfires and the lack of acceptance of prescribed fire as a management tool.

The degree of herbivory (feeding on herbaceous plants) has a significant impact on the dynamics of the site. Historically, periodic grazing by herds of large migratory herbivores was a primary influence. Secondary influences of herbivory by species such as grasshoppers and root feeding organisms impacted the vegetation historically and continue to this day. The management of herbivory by humans through grazing of domestic livestock and/or manipulation of wildlife populations has been a major influence on the ecological dynamics of the site. This management coupled with climate largely dictates the plant communities for the site.

The plant community for this site is dynamic due to the complex interaction of many ecological processes. The interpretive plant community for this site is the reference state. The reference state has been determined by the study of rangeland relic areas, areas protected from excessive disturbance and areas under long term rotational grazing strategies. Trends in plant community dynamics ranging from heavily grazed to lightly grazed areas, seasonal use pastures, and historical accounts have also been used.

The following is a diagram that illustrates the common plant communities that can occur on the site and the transition pathways among communities. The ecological processes will be discussed in more detail in the plant community descriptions following the diagram.

State and transition model

Ecosystem states

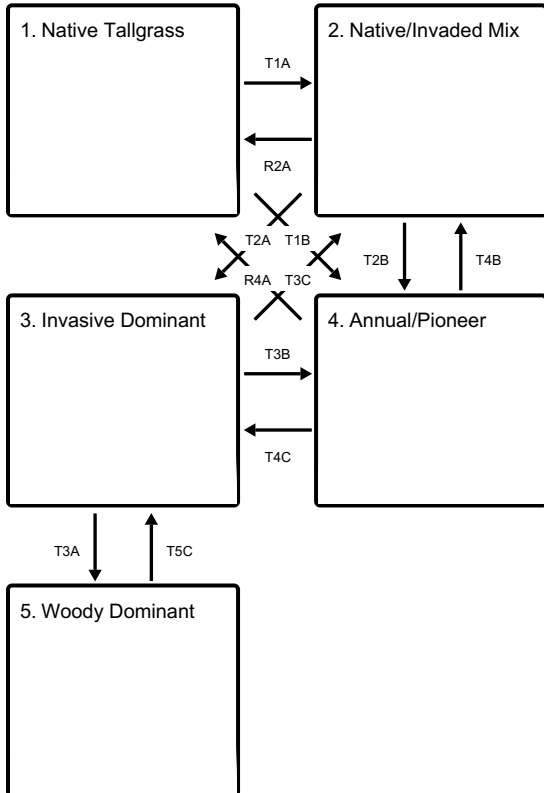

States 1, 5 and 2 (additional transitions)

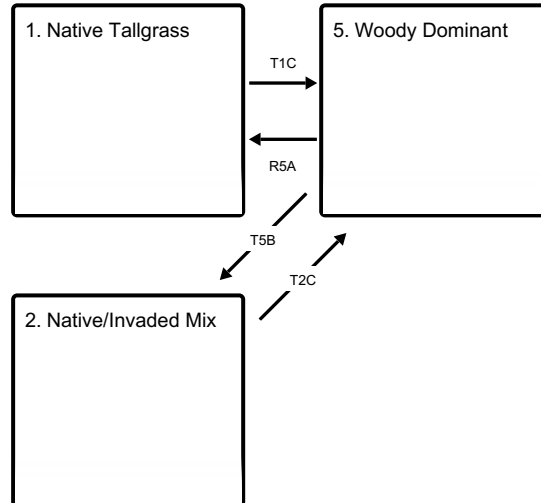

T1A - Reduced native competitiveness allow for introduced grass colonization and expansion.

T1B - Severe disturbance makes resources available to opportunistic species.

T1C - Woody encroachment leading to woody dominance

R2A - Reduced invasive grass competitiveness allows natives to reclaim resources.

T2A - Reduced native competitiveness allow for introduced grass colonization and expansion.

- T2B** - Severe disturbance makes resources available to opportunistic species.
- T2C** - Woody encroachment leading to woody dominance
- T3C** - Reduced invasive grass competitiveness allows natives to reclaim resources.
- T3B** - Severe disturbance makes resources available to opportunistic species.
- T3A** - Woody encroachment leading to woody dominance
- R4A** - Successional processes tie up resources in a more stable community
- T4B** - Successional processes tie up resources in a more stable community
- T4C** - Successional processes tie up resources in a more stable community
- R5A** - Woody removal for return to herbaceous dominance
- T5B** - Woody removal for return to herbaceous dominance
- T5C** - Woody removal for return to herbaceous dominance

State 1 submodel, plant communities

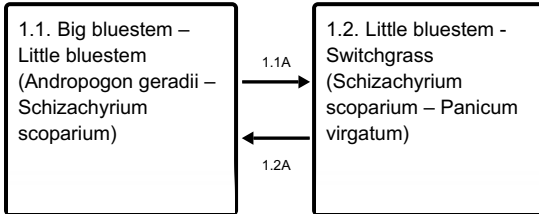

- 1.1A** - Reduced tallgrass vigor due to excessive defoliation intensity and frequency; drought.
- 1.2A** - Improved tallgrass vigor with adequate rest periods; return of normal precipitation.

State 2 submodel, plant communities

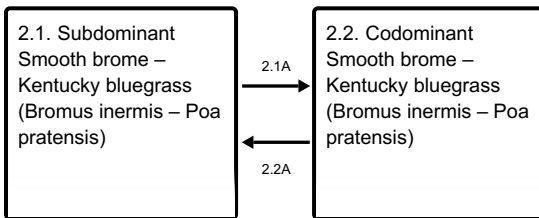

- 2.1A** - Reduced native competitiveness allow for introduced grass colonization and expansion.
- 2.2A** - Reduced invasive grass competitiveness allows natives to reclaim resources.

State 3 submodel, plant communities

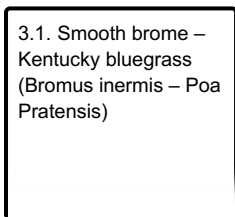

State 4 submodel, plant communities

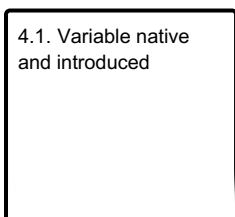

State 5 submodel, plant communities

5.1. Native wooded overstory

State 1 Native Tallgrass

This state comprises the communities within the range of natural variability under historic conditions and disturbance regimes. Patterns created by wildlife use and fire would have created a mosaic of communities across the landscape; however, warm-season tallgrasses are dominant, with a subdominant to minor contribution from native cool-season grasses, forbs, and shrubs. Fire and bison herbivory were the dominant disturbance regimes that historically maintained the tallgrass dominance with a diverse forb component. Furthermore, bison grazing was closely linked to fire patterns as the animals preferred grazing burned areas offering lush regrowth devoid of decadence and of higher nutritive quality. Thus, historic plant communities were subjected to occasional burning and grazing, with substantial rest/recovery periods as the fuel load rebuilt to eventually start this process again. Fire return intervals of 3-4 years served to suppress woody species, particularly the various tree and shrub species prevalent in adjacent riparian corridors. The degree to which observed conditions represent this state largely depends on how closely the management has mimicked these past disturbance effects. Big bluestem and little bluestem are used in this state and transition model as dominant; however many species of native grasses may be present on these sites. Green needlegrass (*Nassella viridula*), western wheatgrass (*Pascopyrum smithii*) and switchgrass (*Panicum virgatum*) may be common in some areas.

Dominant plant species

- big bluestem (*Andropogon gerardii*), grass
- little bluestem (*Schizachyrium scoparium*), grass

Community 1.1

Big bluestem – Little bluestem (*Andropogon gerardii* – *Schizachyrium scoparium*)

This is the interpretive plant community and can be found on areas that are properly managed with prescribed grazing that allows for adequate recovery periods following each grazing event. The plant community consists of 80-95% grasses and grass-likes, 5-10% forbs and 0-5% shrubs. Dominant grasses include Big bluestem, Little bluestem, Indiangrass, Switchgrass, and Tall dropseed. Other grasses and grass-likes are Canada wildrye, Kentucky bluegrass, Prairie junegrass, Sideoats grama, Scribner panicum, forbs and sedges. This plant community is diverse, stable, and productive. Plant community dynamics, nutrient cycles, water cycles, and energy flow are functioning properly. Plant litter is properly distributed with negligible movement off-site and natural plant mortality is very low. This community is resistant to many disturbances except continuous, season-long heavy grazing, tillage, or non-use. Broadcast herbicide application will dramatically reduce forb diversity and abundance.

Dominant plant species

- big bluestem (*Andropogon gerardii*), grass
- little bluestem (*Schizachyrium scoparium*), grass

Community 1.2

Little bluestem - Switchgrass (*Schizachyrium scoparium* – *Panicum virgatum*)

Little bluestem has replaced Big bluestem as the dominant species. Other species, such as switchgrass, and western wheatgrass have also increased. While still within the range of natural variability, energy capture, nutrient cycling, and hydrology are not functioning at their full potential relative to the reference condition.

Dominant plant species

- little bluestem (*Schizachyrium scoparium*), grass

- switchgrass (*Panicum virgatum*), grass

Pathway 1.1A

Community 1.1 to 1.2

Grazing management which does not provide adequate recovery periods will cause a shift from Big bluestem and Little bluestem towards less palatable species, particularly Switchgrass.

Pathway 1.2A

Community 1.2 to 1.1

Management that provides adequate recovery periods and does not annually prevent tallgrass seed set or otherwise impair vigor will facilitate a return to community phase 1.1. In the case of drought, the return to more typical precipitation patterns will promote shift towards tallgrass species.

State 2

Native/Invaded Mix

This state can manifest in three ways: 1) the appearance of introduced cool-season grasses, 2) the expansion of shrubs and/or trees, or 3) some combination of these. Kentucky bluegrass and Smooth brome are the primary cool-season grass invaders in this region, commonly found in roadsides, disturbed areas, and pastures intentionally seeded for cool-season forage. Management practices and/or environmental conditions that are not favorable to native grass vigor may allow introduced grasses to invade the site thereby decreasing native diversity and abundance, particularly of forbs. In the absence of the historic fire regime, woody species may also expand to become an influential component of the community. The invasive component tends to have very high resilience, is extremely difficult to eradicate, and what might be considered a new "contemporary" range of natural variability is seen as competition between the native grasses and introduced/woody species for space and resources.

Dominant plant species

- little bluestem (*Schizachyrium scoparium*), grass
- switchgrass (*Panicum virgatum*), grass
- smooth brome (*Bromus inermis*), grass
- Kentucky bluegrass (*Poa pratensis*), grass

Community 2.1

Subdominant Smooth brome – Kentucky bluegrass (*Bromus inermis* – *Poa pratensis*)

While native warm-season grasses still dominate the site, introduced cool-season species have established a foothold in the system and can be found interspersed throughout the stand. The stand may still have a native tallgrass appearance overall, but brome and/or bluegrass can be easily found. Shrub/tree species may also have begun to expand into areas where they did not persist historically, but the overall appearance can vary depending on the propagation method of a particular species.

Dominant plant species

- little bluestem (*Schizachyrium scoparium*), grass
- switchgrass (*Panicum virgatum*), grass
- smooth brome (*Bromus inermis*), grass
- Kentucky bluegrass (*Poa pratensis*), grass

Community 2.2

Codominant Smooth brome – Kentucky bluegrass (*Bromus inermis* – *Poa pratensis*)

This community is comprised of a relatively even mix of native grasses and invasive species overall. This may manifest as a well-distributed interspersion of natives and invaders, as distinct patches wherein competitors dominate locally, or some combination. Forb diversity and abundance is further diminished.

Dominant plant species

- little bluestem (*Schizachyrium scoparium*), grass
- smooth brome (*Bromus inermis*), grass
- switchgrass (*Panicum virgatum*), grass
- Kentucky bluegrass (*Poa pratensis*), grass

Pathway 2.1A

Community 2.1 to 2.2

Management and/or environmental conditions have afforded a persisting competitive advantage to introduced cool-season grasses, and they begin to dominate the ecological dynamics of the site. The robust invasive component can quickly and effectively exploit opportunities to outcompete and displace natives. Repeated summer use of an area will place the bulk of stressor impacts on native plants, reducing native vigor and allowing invaders to thrive. Likewise, a climate pattern limiting natural moisture to the spring and fall months coincides with peak cool-season growth and may support a similar process.

Pathway 2.2A

Community 2.2 to 2.1

The native component remains in an abundance that can facilitate a return towards more historic conditions if management is modified to shift stressor impacts to the invasive species and promote warm-season grass vigor. Environmental conditions and/or disturbance regimes that strongly favor warm-season grasses can also trend the site towards the reference.

State 3

Invasive Dominant

Introduced cool-season invasion has progressed to the point that native species comprise a negligible portion of the community and the aggressively rhizomatous invasives preclude native germination and seedling survival. The native component may be completely absent, and the site resembles a seeded pasture. Alternatively, the dominant invasives may be woody species. Woody competitiveness for sunlight, water, space, and other resources continues to increase as desirable herbaceous species are shaded out, crowded out, or otherwise suppressed.

Dominant plant species

- smooth brome (*Bromus inermis*), grass
- Kentucky bluegrass (*Poa pratensis*), grass

Community 3.1

Smooth brome – Kentucky bluegrass (Bromus inermis – Poa Pratensis)

This community is typically composed of Smooth brome with bluegrass interspersed among the brome tillers. Warm-season natives, if present, are sparse yet often conspicuous due to pronounced differences in growth habits and metabolic pathways. Community structure and function have been dramatically simplified relative to the reference condition, and very few biotic functional groups are represented in amounts that would influence ecological function. The invasive grass root skein provides good site stability; however, replacement of the deeper roots and complex bunchgrass canopy with the shallower roots and erect tiller canopy of the invaders results in reduced interception and infiltration rates.

Dominant plant species

- smooth brome (*Bromus inermis*), grass
- Kentucky bluegrass (*Poa pratensis*), grass

State 4

Annual/Pioneer

Nutrient cycling, hydrologic function, and/or soil stability have been severely altered, and possibly compromised. This is a highly variable state in which the specific plants observed will depend largely on the original community and the nature of the disturbance. This condition encompasses (but is not necessarily limited to) events such as severe fire impacts, heavy continuous grazing, heavy nutrient inputs, and abandoned cropland.

Dominant plant species

- ragweed (*Ambrosia*), other herbaceous
- thistle (*Cirsium*), other herbaceous
- hoary verbena (*Verbena stricta*), other herbaceous
- pigweed (*Amaranthus*), other herbaceous

Community 4.1

Variable native and introduced

This community is heavily dominated by annual plants that thrive in disturbed areas and often includes annual ragweed, hoary verbena, or amaranths. It is also particularly vulnerable to noxious weed invasion with the most common species being Leafy spurge, Musk and Canada thistles.

Dominant plant species

- ragweed (*Ambrosia*), other herbaceous
- thistle (*Cirsium*), other herbaceous
- pigweed (*Amaranthus*), other herbaceous
- hoary verbena (*Verbena stricta*), other herbaceous

State 5

Woody Dominant

Under historic disturbance regimes, frequent and uncontrolled fire and wildlife browsing served to keep woody species in check. However, in the absence of fire (either wild or prescribed), it's not uncommon for the woody trees and shrubs normally limited to riparian areas to expand into the floodplains, regardless of herbaceous community composition. Wildlife may introduce a seed source to areas not associated with a waterway, such as interdunal depressions.

Dominant plant species

- maple (*Acer*), tree
- eastern cottonwood (*Populus deltoides*), tree
- ash (*Fraxinus*), tree
- boxelder (*Acer negundo*), tree

Community 5.1

Native wooded overstory

Woody species have encroached and established, typically with species such as maples, cottonwood, boxelder, green ash, eastern red cedar and swamp oak.

Dominant plant species

- maple (*Acer*), tree
- eastern cottonwood (*Populus deltoides*), tree
- ash (*Fraxinus*), tree
- boxelder (*Acer negundo*), tree

Transition T1A

State 1 to 2

In the presence of introduced cool-season grasses, environmental conditions and/or management that reduces

native vigor and stand resilience, and frees up resources (space, sunlight, nutrients, water) will allow for colonization of Kentucky bluegrass and Smooth brome. Likewise, similar processes may also allow for woody species to expand.

Transition T1B **State 1 to 4**

There are many possible triggers for this transition that may occur as acute events (e.g. plowing) or cumulative impacts of chronic events (e.g. long-term undermanaged grazing.) The absence of deep-rooted perennial cover exposes the site to topsoil loss, open nutrient cycle, and free space which collectively allow for opportunistic annual species to dominate.

Transition T1C **State 1 to 5**

All herbaceous communities are vulnerable to woody encroachment in the absence of fire and/or browsing and hoof action impacts. This is particularly prominent in areas adjacent to riparian corridors which supply a constant seed source. As tree establishment progresses, the conditions grow increasingly favorable for woody germination and growth.

Restoration pathway R2A **State 2 to 1**

Eradication of introduced cool-season grasses from this site will require long-term, targeted management efforts to create an adverse environment during the spring and late fall when bluegrass and brome are most actively growing, with favorable conditions during the summer to promote native warm-season species. Targeted practices such as prescribed burning, flash grazing, and herbicide are often employed at strategic times of the year to set back undesirable species. The combination of practices should strive to mimic the historic disturbance regimes to which the desirable native species are best adapted.

Transition T2A **State 2 to 3**

If the conditions which initiated and fomented the colonization and expansion of cool- season invasion are not removed or mitigated, stand composition will continue to shift in this direction and begin to resemble a monoculture of brome and/or bluegrass. Due to the dense rhizomatous root mat of brome and bluegrass, native species suffer decreasing opportunities to contribute propagules, and individual plants lost are not replaced by desirable natives.

Transition T2B **State 2 to 4**

There are many possible triggers for this transition that may occur as acute events (e.g. plowing) or cumulative impacts of chronic events (e.g. long-term undermanaged grazing.) The absence of deep-rooted perennial cover exposes the site to topsoil loss, open nutrient cycle, and free space which collectively allow for opportunistic annual species to dominate.

Transition T2C **State 2 to 5**

All herbaceous communities are vulnerable to woody encroachment in the absence of fire and/or browsing impacts. This is particularly prominent in areas adjacent to riparian corridors which supply a constant seed source. As tree establishment progresses, the conditions grow increasingly favorable for woody germination and growth.

Transition T3C **State 3 to 2**

Aggressive intervening actions will be required to simultaneously recolonize native grasses and suppress vigor in

undesirable species. Restoration follows the same principles as the R2A pathway but may also require native range seeding if the latent seedbank is inadequate.

Transition T3B

State 3 to 4

Nutrient cycling, hydrologic function, and/or soil stability have been severely altered, and possibly compromised. This is a highly variable state in which the specific plants observed will depend largely on the original community and the nature of the disturbance.

Transition T3A

State 3 to 5

All herbaceous communities are vulnerable to woody encroachment in the absence of fire and/or browsing impacts. This is particularly prominent in areas adjacent to riparian corridors which supply a constant seed source. As tree establishment progresses, the conditions grow increasingly favorable for woody germination and growth.

Restoration pathway R4A

State 4 to 1

Restoration strategies will depend on the nature of the disturbance and the viability of the seedbank. On pastures, changes to grazing management and favorable moisture conditions may produce a perennial community. However, in abandoned cropland range seeding will likely be necessary to recolonize desirable perennial species.

Transition T4B

State 4 to 2

As the site matures from the annual / pioneer stage, it will transition over to a mix of native and invaded species depending on the seed sources available. In many cases this will be a mix of Smooth brome and Kentucky bluegrass for these sites.

Transition T4C

State 4 to 3

The annual / pioneer stage can transition to an invasive dominant stage if the seed source available after the disturbance is predominantly non-native species.

Restoration pathway R5A

State 5 to 1

The combination of tree size, reduced herbaceous understory, and more mesic conditions makes it increasingly difficult for natural disturbances to restore/maintain the historic tallgrass community, and mature woodlands can no longer be restored with fire. Intensive brush management will be required to mechanically remove the established overstory. Woody control and maintenance will be an ongoing process and may also require chemical methods if sprouting species are present.

Transition T5B

State 5 to 2

Any type of natural act or management practices that kill off the woody species can transition the woody dominant site back to a native / invaded mix as the remaining herbaceous plants and seed source thrive due to the introduction of more sunlight and less woody competition.

Transition T5C

State 5 to 3

Any type of natural act or management practices that kill off the woody species can transition the woody dominant

site back to invasive dominant regime as the remaining herbaceous plants and seed source thrive due to the introduction of more sunlight and less woody competition.

Additional community tables

Inventory data references

Meetings and comments of local, state and regional experts convene and created the ES concepts and STMs. Information presented here has been derived from RANGE-417 archives, Rangeland NRI, and other inventory data. Field observations from range-trained personnel were also used. In addition to the multitude of NRCS field office employees and private landowners that helped with site visits and local knowledge, those involved in developing this site include:

Nebraska NRCS:

Nadine Bishop, State Rangeland Management Specialist
Patrick Cowsert, Resource Soil Scientist
Cassidy Gerdes, Biologist
Dirk Schultz, Soil Conservationist
Dan Shurtliff, Asst. State Soil Scientist (retired)

South Dakota NRCS:

Stan Boltz, State Rangeland Management Specialist
Shane Deranleau, Area Rangeland Management Specialist
Kevin Luebke, State Biologist

Iowa NRCS:

Jess Jackson, Area Grazing Specialist

Minnesota NRCS:

Lance Smith, Area Grazing Specialist

MLRA Office 10:

Stu McFarland, Ecological Site Inventory Specialist
Stacey Clark, Ecological Site Inventory Specialist, QA
Michael Whited, Region 10 Director (retired)
Jo Parsley, Soil Scientist/ Soil Data Quality Specialist
National Soil Survey Center:
Mike Kucera, National Agronomist, Soil Quality & Ecosystems
Steve Peaslee, GIS Specialist, Soil Survey Interpretations

Nebraska Game & Parks Commission:

Gerry Steinauer, Botanist
Scott Wessel, Biologist
Russ Hamer, Biologist
Rebekah Jessen, Biologist

Nebraska Forest Service:

Steve Rasmussen, District Forester

Other references

USDA/NRCS 2006. Land Resource Regions and Major Land Resource Areas of the United States, the Caribbean, and the Pacific Basin. U.S. Department of Agriculture Handbook 296.

USDA/NRCS. 2012. Field Office Technical Guide (Nebraska, Natural Resources Information, Statewide Soil and Site Information, Rangeland Interpretations, Nebraska Range Site Descriptions – Vegetative Zones 3 and 4), U.S. Department of Agriculture, Natural Resources Conservation Service, Nebraska Ecological Sciences.

Fenneman, Nevin M. 1916. Physiographic Subdivision of the United States. Annals of the Association of American Geographers.

Omernik, J.M. 1997. Ecoregions of the Conterminous United States. Annals of the Association of American Geographers, v.77, no. 1, p.118-125.

Cleland_2007, USDA/USFS. 2007. Ecological Subregions: Sections and Subsections for the Conterminous United States. Washington, DC: USDA - Forest Service.

Contributors

Stan Boltz/Dana Larsen
Nadine Bishop
Greg Clark

Approval

Suzanne Mayne-Kinney, 10/03/2024

Acknowledgments

Non-discrimination Statement

In accordance with Federal civil rights law and U.S. Department of Agriculture (USDA) civil rights regulations and policies, the USDA, its Agencies, offices, and employees, and institutions participating in or administering USDA programs are prohibited from discriminating based on race, color, national origin, religion, sex, gender identity (including gender expression), sexual orientation, disability, age, marital status, family/parental status, income derived from a public assistance program, political beliefs, or reprisal or retaliation for prior civil rights activity, in any program or activity conducted or funded by USDA (not all bases apply to all programs). Remedies and complaint filing deadlines vary by program or incident.

Persons with disabilities who require alternative means of communication for program information (e.g., Braille, large print, audiotope, American Sign Language, etc.) should contact the responsible Agency or USDA's TARGET Center at (202) 720-2600 (voice and TTY) or contact USDA through the Federal Relay Service at (800) 877-8339. Additionally, program information may be made available in languages other than English.

To file a program discrimination complaint, complete the USDA Program Discrimination Complaint Form, AD-3027, available online and at any USDA office, or write a letter addressed to USDA and provide in the letter all of the information requested in the form. To request a copy of the complaint form, call (866) 632- 9992. Submit your completed form or letter to USDA by: (1) mail: U.S. Department of Agriculture, Office of the Assistant Secretary for Civil Rights, 1400 Independence Avenue, SW, Washington, D.C. 20250-9410; (2) fax: (202) 690-7442; or (3) email: program.intake@usda.gov.

Rangeland health reference sheet

Interpreting Indicators of Rangeland Health is a qualitative assessment protocol used to determine ecosystem condition based on benchmark characteristics described in the Reference Sheet. A suite of 17 (or more) indicators are typically considered in an assessment. The ecological site(s) representative of an assessment location must be known prior to applying the protocol and must be verified based on soils and climate. Current plant community cannot be used to identify the ecological site.

Author(s)/participant(s)	
Contact for lead author	
Date	10/03/2024
Approved by	Suzanne Mayne-Kinney
Approval date	

Indicators

1. **Number and extent of rills:**

2. **Presence of water flow patterns:**

3. **Number and height of erosional pedestals or terracettes:**

4. **Bare ground from Ecological Site Description or other studies (rock, litter, lichen, moss, plant canopy are not bare ground):**

5. **Number of gullies and erosion associated with gullies:**

6. **Extent of wind scoured, blowouts and/or depositional areas:**

7. **Amount of litter movement (describe size and distance expected to travel):**

8. **Soil surface (top few mm) resistance to erosion (stability values are averages - most sites will show a range of values):**

9. **Soil surface structure and SOM content (include type of structure and A-horizon color and thickness):**

10. **Effect of community phase composition (relative proportion of different functional groups) and spatial distribution on infiltration and runoff:**

11. **Presence and thickness of compaction layer (usually none; describe soil profile features which may be mistaken for compaction on this site):**

12. **Functional/Structural Groups (list in order of descending dominance by above-ground annual-production or live foliar cover using symbols: >>, >, = to indicate much greater than, greater than, and equal to):**

Dominant:

Sub-dominant:

Other:

Additional:

13. **Amount of plant mortality and decadence (include which functional groups are expected to show mortality or decadence):**
-

14. **Average percent litter cover (%) and depth (in):**
-

15. **Expected annual annual-production (this is TOTAL above-ground annual-production, not just forage annual-production):**
-

16. **Potential invasive (including noxious) species (native and non-native). List species which BOTH characterize degraded states and have the potential to become a dominant or co-dominant species on the ecological site if their future establishment and growth is not actively controlled by management interventions. Species that become dominant for only one to several years (e.g., short-term response to drought or wildfire) are not invasive plants. Note that unlike other indicators, we are describing what is NOT expected in the reference state for the ecological site:**
-

17. **Perennial plant reproductive capability:**
-