

Ecological site F105XY019WI Dry Upland

Last updated: 2/23/2024
Accessed: 05/18/2024

General information

Provisional. A provisional ecological site description has undergone quality control and quality assurance review. It contains a working state and transition model and enough information to identify the ecological site.

MLRA notes

Major Land Resource Area (MLRA): 105X–Upper Mississippi River Bedrock Controlled Uplands and Valleys

The Northern Mississippi Valley Loess Hills area corresponds closely to the Western Coulees and Ridges and Southwest Savanna Ecological Landscapes. Some of the following brief overview is borrowed from the Wisconsin Department of Natural Resources Ecological Landscape publication (2015).

Fifty-two percent of the Upper Mississippi River Bedrock Controlled Uplands and Valleys MLRA is in Wisconsin; Iowa, Minnesota, and Illinois contain the rest. This region is the only area in Wisconsin that has not been covered by glaciers within the past 2.4 million years. The Wisconsin portion of this MLRA is approximately 7.4 million acres (11,600 square miles). The landscape is characterized by dissected topography with deeply-incised, steep-walled valleys between bedrock controlled ridges.

Though it's called the "Driftless Region", some glacial drift is found in the major river valleys of this region in the form of outwash, deposited by proglacial streams of glacial meltwater. Wisconsin's most recent glaciations also impacted the sediment of the area through the deposition of loess. After the glacier receded and before vegetation established, the bare surfaces of the glaciated areas were highly susceptible to wind erosion. As a result, a veneer of loess (wind-blown silt) was deposited over the entire region. The thickest deposits—nearly five meters—are on ridges near the Mississippi River and gradually thin moving eastward. The loess caps in Dane and Green counties are generally 0.5-1.5 meters deep. Much of the loess has eroded downslope and collected in floodplains.

Bedrock is shallow throughout this MLRA and is a major influence on topography and hydrology. Most of the MLRA has bedrock within two meters, except in the deep river valleys that are filled with outwash and alluvium materials. Sandstone is the dominant bedrock type in MLRA 105, but the southernmost portion is dominated by dolomite. Military Ridge is an escarpment that straddles the boundary between sandstone and dolomite bedrock. The sandstone north of the ridge is weaker than the erosion-resistant dolomite south of the ridge. The sandstone is deeply cut and dissected into steep slopes and valleys. The dolomite-controlled ridges tend to be less dissected and broader with more gentle, south sloping topography. Geomorphic and fluvial processes formed these landscapes by way of sheet wash, soil creep, and flowage. These processes eroded the hillslopes, cut into bedrock, and transported the debris to streams, forming floodplains and terraces.

Underfit streams are common in MLRA 105, especially in the southern portion. These streams currently occupy large river valleys—especially those of the Black, Chippewa, Mississippi, and Wisconsin Rivers—that were carved by proglacial meltwater streams carrying much larger quantities of water than what's present today. As the climate dried, waterflow decreased and the valleys filled with alluvial sediment. Narrow meanders were formed by the shrinking streams and are often dissimilar to the meanders of the larger valleys they occupy. Fluvial landforms – including terraces, oxbow lakes, sandbars, eroding bluffs, and large floodplain complexes – are found within these large valleys and are subject to varying flooding frequencies, intensities, and durations.

Karst topography formed in this region from dissolution of carbonate bedrock by surface and groundwater. Dolomite and limestone are more easily affected by dissolution, but karst topography also formed in sandstone. Erosion by

water (stream meanders, rain/runoff, and groundwater), wind, and frost weaken joints and bedding planes that can cause collapse. In addition, sandstone materials collapse into cavities in underlying dolomite or limestone.

Historically, MLRA 105 was dominated by oak forests and oak openings making up more than 50% of the area. Prairies were significant and covered 32% of the area south of Military Ridge. Maple-basswood forests covered 19% of the area north of Military Ridge. Dominant tree species were white oak (*Quercus alba*), bur oak (*Quercus macrocarpa*), black oak (*Quercus velutina*), and sugar maple (*Acer saccharum*).

Classification relationships

Relationship to Established Framework and Classification Systems:

Habitat Types of S. Wisconsin (Kotar, 1996): The sites in this ES keyed out to *Pinus strobus/Vaccinium-Cornus racemose* [PVCr] and *Acer rubrum/ Desmodium-Vaccinium* [ArDe-V].

Biophysical Settings (Landfire, 2014): This ES is largely mapped as Laurentian-Acadian Northern Pine Forest, Laurentian-Acadian Northern Hardwoods Forest, North-Central Interior Dry Oak Forest and Woodland, Managed Tree Plantation-Northern and Central Hardwood and Conifer Plantation Group, Eastern Cool Temperate Close Grown Crop, Eastern Cool Temperate Row Crop, and Developed-Low Intensity

WDNR Natural Communities (WDNR, 2015): This ES is most closely described as the Southern Dry Forest by the Wisconsin DNR.

Hierarchical Framework Relationships:

Major Land Resource Area (MLRA): Upper Mississippi River Bedrock Controlled Uplands and Valleys (105)

USFS Subregions: Menominee Eroded Pre-Wisconsin Till (222La), Melrose Oak Forest and Savannah (222Lb), Mississippi-Wisconsin River Ravines (222Lc)

Wisconsin DNR Ecological Landscapes: Western Coulee and Ridges

Ecological site concept

The Dry Upland ecological site occupies approximately 308,000 acres across MLRA 105, or about 4.5% of total land area. It is the fifth-most extensive site in the MLRA. It is found in upland positions across diverse landforms throughout the MLRA. 92% of the acreage of this site is found north of the LaCrosse River in upland positions on sandstone hills and in the wide outwash terraces of the Chippewa, Mississippi, Black, and LaCrosse rivers. Most of the remaining acreage is found in the outwash terraces of the Wisconsin River.

This site is characterized by deep to very deep, well drained to excessively drained, sandy soils.

Associated sites

F105XY002WI	Wet Sandy Floodplain These sites form in deep, sandy alluvium and outwash deposits in floodplains, especially those along the Chippewa, Black, and Wisconsin rivers. They support vegetation tolerant of seasonal flooding. They are sometimes saturated enough for hydric conditions to occur. They are found in floodplains adjacent to Dry Upland.
F105XY004WI	Wet Sandy Lowland These sites form in depressions and drainageway in deep, sandy outwash deposits. They are very poorly or poorly drained and are saturated long enough for hydric conditions to occur. They are sometimes found adjacent to adjacent to Dry Upland in lower landscape positions.
F105XY006WI	Moist Sandy Lowland These sites form in sandy outwash deposits along major waterways. They are somewhat poorly drained. They are sometimes found adjacent to adjacent to Dry Upland in lower landscape positions.

Similar sites

F105XY017WI	<p>Shallow Dry Upland</p> <p>These sites form in sandy materials deposited by wind, water, gravity, or weathered from sandstone bedrock. They are somewhat excessively to excessively drained. They are similar to Dry Upland but have bedrock contact within one meter of the soil surface.</p>
R105XY018WI	<p>Dry Mollic or Umbric Upland</p> <p>These sites form in sandy materials deposited by wind, water, or weathered from sandstone bedrock. They have deep, dark surfaces. They are moderately well to excessively drained. They are similar to Dry Upland but have deeper surfaces (mollic or umbric rather than ochric epipedons) and may sometimes have bedrock contact within one meter of the soil surface.</p>
F105XY009WI	<p>Sandy Upland</p> <p>These sites form in deep sandy materials deposits by water and wind. They are moderately well to somewhat excessively drained. They are similar to Dry Upland but are somewhat wetter and usually made from materials that have not weathered in place.</p>

Table 1. Dominant plant species

Tree	(1) <i>Pinus strobus</i> (2) <i>Quercus alba</i>
Shrub	(1) <i>Prunus serotina</i> (2) <i>Cornus racemosa</i>
Herbaceous	(1) <i>Parthenocissus quinquefolia</i>

Physiographic features

These sites form on ridges, hills, terraces, outwash plains, sand sheets, valley trains, dunes, pediments, and glacial lakes in the summit to backslope position. Slope shape is convex or linear. Slopes range from 0 to 15 percent. Elevation of the landform ranges from 705 to 1001 feet (215 to 305 meters) above sea level.

These sites are not subject to inundation by water. They generally lack evidence of a seasonally high water table within 80 inches (200 cm) of the soil surface. Runoff potential is negligible to medium.

Table 2. Representative physiographic features

Hillslope profile	(1) Summit (2) Shoulder (3) Backslope
Slope shape across	(1) Convex
Slope shape up-down	(1) Linear
Landforms	(1) Hill (2) Terrace (3) Outwash plain (4) Valley train (5) Dune (6) Pediment (7) Glacial lake
Runoff class	Negligible to medium
Flooding frequency	None
Ponding frequency	None
Elevation	215–305 m
Slope	0–15%
Water table depth	203 cm
Aspect	Aspect is not a significant factor

Climatic features

The climate of the Upper Mississippi River Bedrock Controlled Uplands and Valleys MLRA is typical of southern Wisconsin, with warmer winters, warmer summers, and higher precipitation rates than MLRA in northern Wisconsin. The MRA stretches over about 2.9 degrees of latitude, or nearly 200 miles, from its northern tip in Barron county to its southern Wisconsin extent on the border of Illinois. This results in considerable variation in climate throughout the MLRA. The growing season ranges from 117 to 181 growing degree days, with longer growing seasons in the southern portion.

The average annual precipitation for this ecological site is 34 inches. The average annual snowfall is 41 inches. The annual average maximum and minimum temperatures are 55°F and 34°F, respectively.

Table 3. Representative climatic features

Frost-free period (characteristic range)	118-129 days
Freeze-free period (characteristic range)	149-153 days
Precipitation total (characteristic range)	813-889 mm
Frost-free period (actual range)	113-134 days
Freeze-free period (actual range)	136-161 days
Precipitation total (actual range)	787-889 mm
Frost-free period (average)	124 days
Freeze-free period (average)	150 days
Precipitation total (average)	864 mm

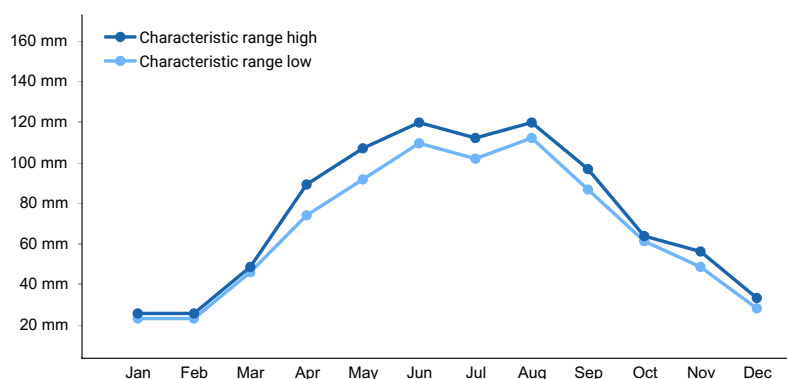

Figure 1. Monthly precipitation range

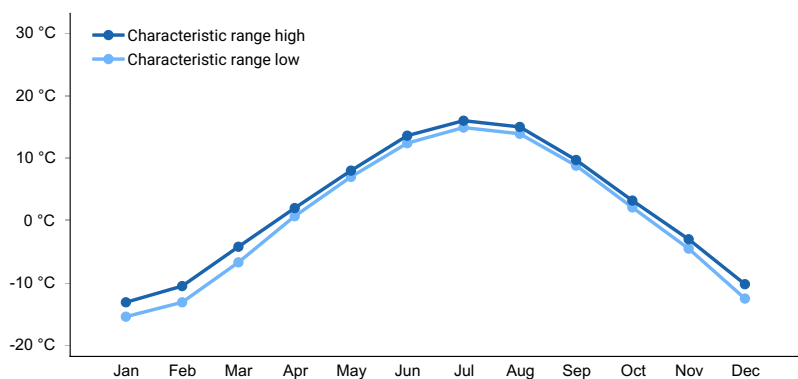

Figure 2. Monthly minimum temperature range

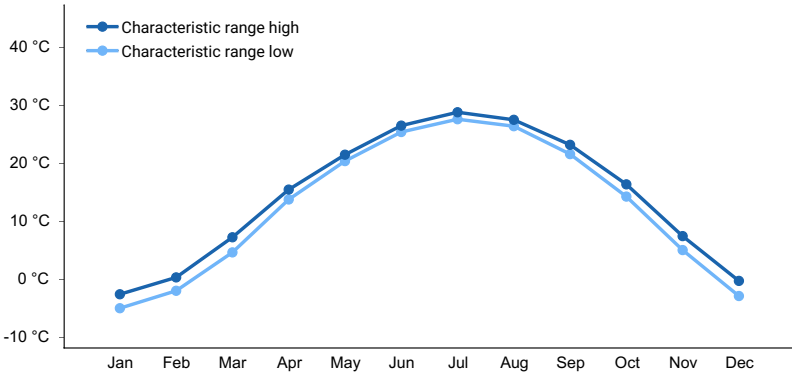

Figure 3. Monthly maximum temperature range

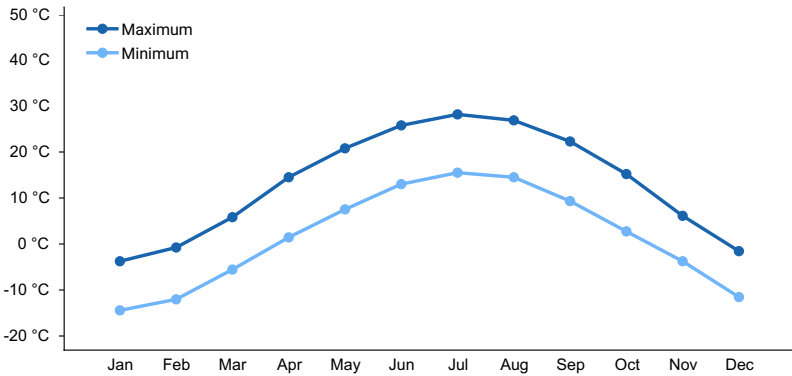

Figure 4. Monthly average minimum and maximum temperature

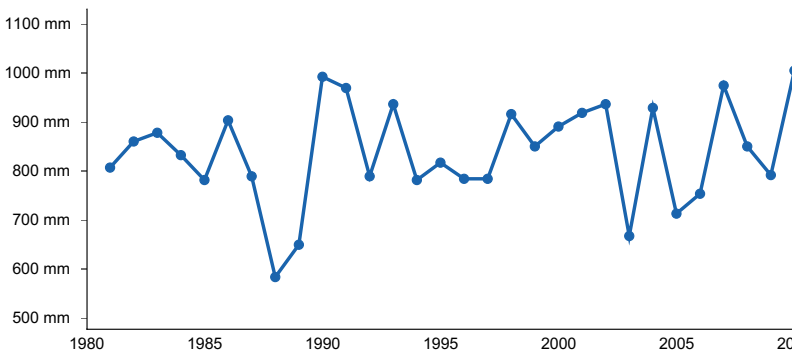

Figure 5. Annual precipitation pattern

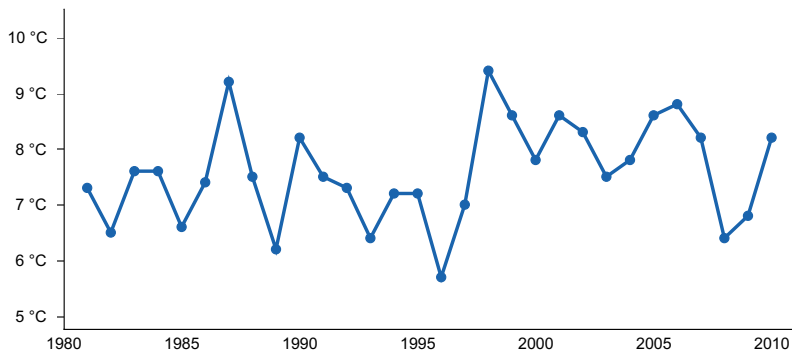

Figure 6. Annual average temperature pattern

Climate stations used

- (1) RIDGELAND 1 NNE [USC00477174], Dallas, WI
- (2) EAU CLAIRE RGNL AP [USW00014991], Eau Claire, WI
- (3) MENOMONIE [USC00475335], Menomonie, WI

- (4) AUGUSTA RS [USC00470382], Augusta, WI
- (5) BOSCOBEL AP [USW00094994], Boscobel, WI
- (6) SPARTA [USC00477997], Sparta, WI
- (7) DURAND [USC00472279], Durand, WI
- (8) LONE ROCK TRI CO AP [USW00014921], Spring Green, WI
- (9) PRAIRIE DU CHIEN [USC00476827], Prairie du Chien, WI

Influencing water features

Water is received through precipitation and runoff from adjacent uplands. Water is lost from the site primarily through runoff, evapotranspiration, and groundwater recharge.

Permeability of the soils is slow to rapid. The hydrologic soil group is A.

Wetland description

Hydrogeomorphic Wetland Classification: None

Cowardin Wetland Classification: None

Soil features

This site is represented by the Brice, Chelsea, Drammen, Gosil, Gotham, Plainfield, Tarr, and Windward soil series. Quartzipsamments account for 43% of the acreage of this site. Udipsamments account for 40% of the acreage. Hapludalfs make up the remaining acreage.

These sites form sandy outwash, sandy and loamy alluvium, sandy colluvium, sandy lacustrine deposits, wind-blown sands, and in sandy residuum weathered from sandstone. They lack bedrock contact within one meter of the soil surface. Subsurface fragments smaller than 3 inches in diameter (gravel) may occupy up to 14% soil volume. Fragments may be mixed rocks deposits by flowing water, unconsolidated rocks deposited by gravity on slopes, or fragments of weathered bedrock. These soils are well drained to excessively drained. They do not meet hydric soil requirements. Soils are slightly to strongly acid. They generally lack accumulations of secondary carbonates.



Figure 7. Tarr soil series sampled on 07/20/2020 in Monroe County, WI.

Table 4. Representative soil features

Parent material	(1) Eolian sands (2) Outwash (3) Residuum (4) Alluvium (5) Colluvium (6) Glaciofluvial deposits
Surface texture	(1) Sand (2) Loamy sand
Drainage class	Well drained to excessively drained

Permeability class	Moderately slow to rapid
Soil depth	102–203 cm
Surface fragment cover <=3"	0–3%
Surface fragment cover >3"	0–14%
Available water capacity (0-150.1cm)	3.33–6.27 cm
Soil reaction (1:1 water) (0-100.1cm)	5.5–6.5
Subsurface fragment volume <=3" (0-100.1cm)	0–14%
Subsurface fragment volume >3" (0-100.1cm)	0–3%

Ecological dynamics

Perhaps the most important ecological characteristic of this Ecological Site, in terms of its influence on forest community dynamics, is its lack of capacity to support the high to moderate soil moisture and nutrient requiring species such as sugar maple, basswood and white ash, the shade-tolerant species, that typically dominate the more productive sites throughout Wisconsin.

In pre-European settlement time wild fire was the main controlling factor of forest community dynamics. Following a severe, stand-replacing fire, any of the species present on the landscape could become established, depending on seed source availability and specific conditions of post-fire seedbed. The newly established young stands of any species were easily eliminated by recurring fires, but differences in fire-resisting properties among the species began to play a role in any species' survival success. White pine is best adapted for long-term success on this Ecological Site. Although vulnerable to damage or elimination by fire in early life it eventually develops thick fire-resistant bark which helps to extend its longevity, in some cases for up to four centuries or more. These survival properties assure the species' relatively continuous seed source in the region as a whole. White pine is also moderately shade-tolerant in early life which means that it can become established in some pioneer communities, such as aspen – white birch stands, or in poorly stocked oak and red maple dominated communities. Red pine had in the past been a common associate of white pine stands. It shares some of the fire-resisting properties of white pine, but it lacks shade-tolerance and does not become established in the understory. For this reason, it has not maintained its presence in current stands and its seed source has been greatly reduced throughout its natural range following the onset of fire suppression. Several species of oak are common members of forest communities on this ecological site. Northern pin oak (*Q. ellipsoidalis*) and, to a lesser degree, black oak (*Q. velutina*), are intolerant of shade and do not reproduce from seed under existing canopies. However, following fire or clear cutting they respond by sprouting from stumps. In the absence of disturbance, they are replaced—through succession—by more shade-tolerant white pine, red maple (*Acer rubrum*), or white oak (*Quercus alba*).

Red maple has not been identified by Finley (1976) as an important component of pre-settlement pine or oak forests, but it is a prominent member in current stands. Absence of fire since the original logging era is probably the main reason. Red maple is extremely sensitive to fire damage, but is a prolific and early seed producer. Stems of 2-4 inches in diameter can produce large amounts of seed (USDA For. Serv. 1990). It is sufficiently shade-tolerant to become established in the understories of most communities on sandy soils. On this Ecological Site it behaves similarly to white pine, but because of its much smaller size at maturity, it does not compete with white pine in the upper canopy.

Some portions of this ES may support grassland or oak savanna and restoration/establishment efforts have had some success.

State and transition model

Ecosystem states

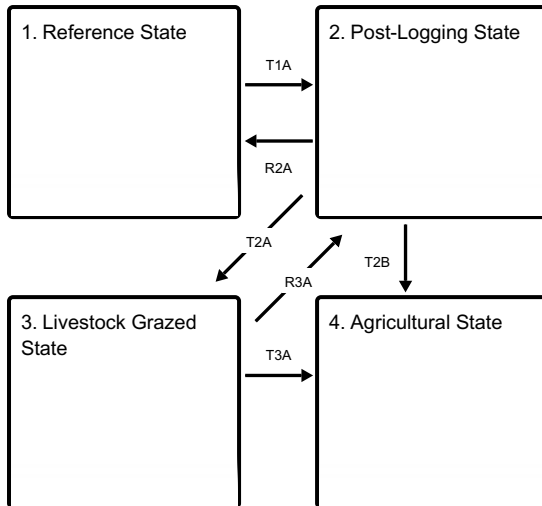

T1A - Stand replacing disturbance e.g., blow-down and fire, or clear-cutting followed by fire. Regeneration by natural seeding or planting.

R2A - Fire control, time, natural succession.

T2A - Grazing by livestock. Disruption of tree regeneration and ground vegetation.

T2B - Removal of natural vegetation, plowing, fertilizing, irrigating, planting agricultural crops.

R3A - Removal of livestock from stands.

T3A - Removal of natural vegetation, plowing, fertilizing, irrigating, planting agricultural crops.

State 1 submodel, plant communities

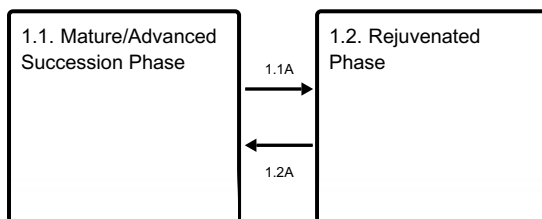

1.1A - Light to moderate intensity fires, blow-downs, ice storms.

1.2A - Disturbance-free period 30+ years

State 2 submodel, plant communities

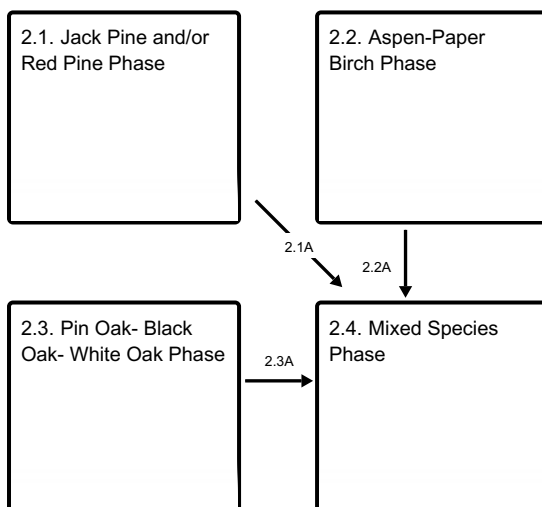

2.1A - Immigration and establishment of white pine and red maple.

2.2A - Immigration and establishment of white pine and red maple.

2.3A - Immigration and establishment of white pine and red maple.

State 3 submodel, plant communities

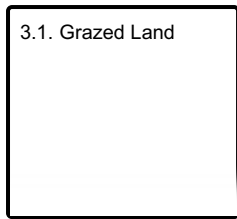

State 4 submodel, plant communities

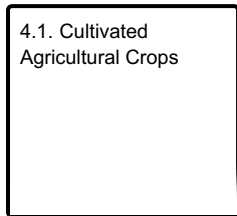

State 1 Reference State

In absence of stand-leveling disturbances the Reference State Community oscillates between two easily definable community phases, a mature, or late successional, community phase and a rejuvenated community phase. The major difference between these two states being the level and degree of small scale disturbance leading to canopy openings and the resulting abundance and age of canopy tree species as well as the shrub layer. Typically this state is characterized by a mixed forest of White pine, Black, Pin, and White Oak, and Red maple. A mixed presence of Red pine, and Jack pine could occur as well.

Community 1.1 Mature/Advanced Succession Phase

A mature forest community contains a super-canopy, or a scattering, of large white pine trees. In pre-European settlement time such trees would have been anywhere from 80 to more than 300 years old (Sterns, 1950). Common associates have been red pine (*P. resinosa*), and white oak (*Q. alba*). However, only white pine and white oak are moderately shade-tolerant and able to reproduce in small canopy openings and remain as permanent members of mature community in absence of moderate to severe disturbance. Red maple (*Acer rubrum*) had not been an important species in pre-settlement forests, but is today the most successful reproducing tree species in forest communities on this Ecological Site. While this ES was likely typified by fire disturbance these species are likely to dominate in the absence of fire as well.

Dominant plant species

- eastern white pine (*Pinus strobus*), tree
- white oak (*Quercus alba*), tree
- black oak (*Quercus velutina*), tree
- pin oak (*Quercus palustris*), tree
- red maple (*Acer rubrum*), tree
- black cherry (*Prunus serotina*), shrub
- gray dogwood (*Cornus racemosa*), shrub
- Virginia creeper (*Parthenocissus quinquefolia*), other herbaceous

Community 1.2 Rejuvenated Phase



The canopy of the rejuvenated community is still dominated by original species, but the understory now also includes a well established younger cohort and perhaps a few additional seedlings and saplings of less shade tolerant species.

Dominant plant species

- eastern white pine (*Pinus strobus*), tree
- red maple (*Acer rubrum*), tree
- northern red oak (*Quercus rubra*), tree
- white oak (*Quercus alba*), tree
- black cherry (*Prunus serotina*), shrub
- Virginia creeper (*Parthenocissus quinquefolia*), other herbaceous

Pathway 1.1A

Community 1.1 to 1.2

Light intensity fires, crown breakage from ice and snow and small scale blow-downs create canopy openings, releasing advance regeneration and stimulating new seedling establishment. Some additional less shade tolerant species such as red oak may be able to enter the community.

Pathway 1.2A

Community 1.2 to 1.1

A long period without major canopy disturbance allows gradual replacement of oldest canopy trees by younger cohorts. Small scale disturbances may still occur periodically, but once second or third canopies are established there is minimal new regeneration taking place and the forest gradually returns to mature state.

State 2

Post-Logging State

Post-logging state may consist of considerable diversity of pioneer and mid-successional community phases. Here we are describing four, most commonly found under current conditions.

Community 2.1

Jack Pine and/or Red Pine Phase

Jack pine and red pine have historically been almost entirely dependent on fire for regeneration. Jack pine is a predominantly a northern species and in southern part of Wisconsin seldom approaches its growth potential. Everywhere it occurs it is a pronounced pioneer, highly light demanding and resistant to drought and frost. It has low requirements for soil organic matter and nutrients. It is a prolific producer of seed and it often colonizes burnt over areas. Forest fires speed natural regeneration by opening the cones. However, today, jack pine is regenerated mostly by planting. Without disturbance jack pine does not regenerate and is readily succeeded by various species, even those of only moderate shade tolerance, such as white pine and red oak. Historically, red pine has often occurred in mixtures with jack pine. In terms of light, soil moisture and nutrient requirements it is intermediate between jack and white pines. In contrast to jack pine, natural red pine regeneration is often found in moderately dense pure or mixed pine stands, although not to the same extent as is white pine. Under current ecological and economic conditions red pine is regenerated almost entirely by planting.

Dominant plant species

- jack pine (*Pinus banksiana*), tree
- red pine (*Pinus resinosa*), tree

Community 2.2

Aspen-Paper Birch Phase

Although a ubiquitous species, quaking aspen (*Populus tremuloides*) is far more characteristic of northern rather than southern forest regions. Its most notable ecological characteristic is the ability to rapidly invade cut-over and burned-over areas. However, its perpetuation depends entirely on recurrence of disturbance. Because of its extreme intolerance to shade, it is readily replaced by many tree species in the absence of disturbance. Once in place, aspen reproduces entirely by sprouting from extensive, superficial root systems (root suckering). Most aspen stands on this Ecological Site resulted from sprouting following clear cutting of mixed stands of pine and/or oak, in which some aspen trees were still present. Paper birch (*Betula papyrifera*) is often a member of aspen stands. It shares aspen's intolerance of shade and also produces small, winged seeds that readily disperse by wind. It does not sucker from root sprouts, but it readily sprouts from stumps upon clear cutting. It also has greater ability than does aspen of reproducing from seed under favorable seedbed conditions and in presence of large canopy openings. However in absence of disturbance it also succeeds to other species.

Dominant plant species

- quaking aspen (*Populus tremuloides*), tree
- paper birch (*Betula papyrifera*), tree

Community 2.3

Pin Oak- Black Oak- White Oak Phase

On this Ecological Site these three oak species occur in mixtures dominated by any of them. In some stands there also occur red oak, bur oak (*Q. macrocarpa*) or shagbark hickory (*Carya ovata*). Community composition and structure is a function of composition of the preceding, cut-over, or burned-over community and time since the disturbance. Time since disturbance is an important factor because of significant differences in sprouting abilities and success of regeneration from seed, among the participating species. Pin and black oak typically exist in current stands as multi-stem clusters resulting from stump sprouting, while white oak often reproduces from seed and gradually gains canopy dominance because of its greater shade tolerance than that of other oak species.

Dominant plant species

- pin oak (*Quercus palustris*), tree
- black oak (*Quercus velutina*), tree
- white oak (*Quercus alba*), tree

Community 2.4 Mixed Species Phase



This community phase is considered a mid-successional community between the pioneering communities 2.1, 2.2, 2.3 and the Reference State. The community is characterized by canopy dominance of any of the early - succession species (i.e.: oaks, aspen - birch, jack pine) and strong presence in the understory of white pine and/or red maple seedlings and saplings.

Dominant plant species

- jack pine (*Pinus banksiana*), tree
- red pine (*Pinus resinosa*), tree
- quaking aspen (*Populus tremuloides*), tree
- white oak (*Quercus alba*), tree
- northern red oak (*Quercus rubra*), tree
- eastern white pine (*Pinus strobus*), tree
- red maple (*Acer rubrum*), tree

Pathway 2.1A Community 2.1 to 2.4

Immigration and establishment of relatively shade tolerant white pine and red maple into shade – intolerant communities of aspen – birch, oaks or jack pine.

Pathway 2.2A Community 2.2 to 2.4

Immigration and establishment of relatively shade tolerant white pine and red maple into shade – intolerant communities of aspen – birch, oaks or jack pine.

Pathway 2.3A Community 2.3 to 2.4

Immigration and establishment of relatively shade tolerant white pine and red maple into shade – intolerant communities of aspen – birch, oaks or jack pine.

State 3 Livestock Grazed State

Livestock grazed forests are more often referred to as woodlands rather than forests because this long-term land use significantly changes some soil characteristics and nature of vegetative community. Species composition is altered by selective browsing and grazing as well as by distribution of seeds and other propagules by grazing animals. In addition, soil compaction differentially affects germination and establishment of plant species, including

trees.

Community 3.1 Grazed Land

Site phase consists of various grasses and forbs impacted by livestock grazing.

State 4 Agricultural State

Production of agricultural crops. Routine usage of tillage, fertilizer, and other field practices.

Community 4.1 Cultivated Agricultural Crops

Sites phase consists of various crops being grown.

Transition T1A State 1 to 2

Stand-replacing disturbance, such as blow-down, or ice storm, followed by fire, or clear-cut logging, followed by natural regeneration or site preparation and planting.

Restoration pathway R2A State 2 to 1

Time (50-100 years) and natural succession by white pine will lead back to the reference state. Minimal disturbance during the successional period.

Transition T2A State 2 to 3

Prolonged grazing by livestock

Transition T2B State 2 to 4

Elimination of forest cover and introduction of tilling, fertilizing an/or irrigation.

Restoration pathway R3A State 3 to 2

Removal of livestock, natural succession. Results may be sped up by planting and initial outcomes will be heavily influenced by seed source and adjacent plant communities.

Transition T3A State 3 to 4

Elimination of forest cover and introduction of tilling, fertilizing an/or irrigation.

Additional community tables

Inventory data references

Plot and other supporting inventory data for site identification and community phases is located on a NRCS North Central Region shared and one drive folder. University of Wisconsin-Stevens Point described soils, took photographs, and inventoried vegetation data at community phases within the reference state. The data sources

include WI ESD Plot Data Collection Form - Tier 2, Revele Method, NASIS pedon description, NRCS SOI 036, photographs, and Kotar Habitat Types.

Other references

Cleland, D.T.; Avers, P.E.; McNab, W.H.; Jensen, M.E.; Bailey, R.G., King, T.; Russell, W.E. 1997. National Hierarchical Framework of Ecological Units. Published in, Boyce, M. S.; Haney, A., ed. 1997. Ecosystem Management Applications for Sustainable Forest and Wildlife Resources. Yale University Press, New Haven, CT. pp. 181-200.

Curtis, J.T. 1959. Vegetation of Wisconsin: an ordination of plant communities. University of Wisconsin Press, Madison. 657 pp.

Finley, R. 1976. Original vegetation of Wisconsin. Map compiled from U.S. General Land Office notes. U.S. Forest Service, North Central Forest Experiment Station, St. Paul, Minnesota.

NatureServe. 2018. International Ecological Classification Standard: Terrestrial Ecological Classifications. NatureServe Central Databases. Arlington, VA. U.S.A. Data current as of 28 August 2018.

Kotar, J., J. A. Kovach, and T. L. Burger. 2002. A Guide to Forest Communities and Habitat Types of Northern Wisconsin. Second edition. University of Wisconsin-Madison, Department of Forest Ecology and Management, Madison.

Kotar, J., J. A. Kovach, and T. L. Burger. 1996. A Guide to Forest Communities and Habitat Types of Southern Wisconsin. University of Wisconsin-Madison, Department of Forest Ecology and Management, Madison.

Kotar, J., and T. L. Burger. 2017. Wetland Forest Habitat Type Classification System for Northern Wisconsin: A Guide for Land Managers and landowners. Wisconsin Department of Natural Resources, PUB-FR-627 2017, Madison.

Schulte, L.A., and D.J. Mladenoff. 2001. The original U.S. public land survey records: their use and limitations in reconstructing pre-European settlement vegetation. *Journal of Forestry* 99:5–10.

Schulte, L.A., and D.J. Mladenoff. 2005. Severe wind and fire regimes in northern forests: historical variability at the regional scale. *Ecology* 86(2):431–445.

Schulte, L.A., and D.J. Mladenoff. 2005. Severe wind and fire regimes in northern forests: historical variability at the regional scale. *Ecology* 86(2):431–445.

United States Department of Agriculture, Natural Resources Conservation Service. 2006. Land Resource and Major Land Resource Areas of the United States, the Caribbean, and the Pacific Basin. U.S. Department of Agriculture Handbook 296.

Wisconsin Department of Natural Resources. 2015. The ecological landscapes of Wisconsin: An assessment of ecological resources and a guide to planning sustainable management. Wisconsin Department of Natural Resources, PUB-SS-1131 2015, Madison.

Contributors

Jacob Prater, Associate Professor at University of Wisconsin Stevens Point

Bryant Scharenbroch, Assistant Professor at University of Wisconsin Stevens Point

John Kotar, Ecological Specialist Independent Contractor

Approval

Suzanne Mayne-Kinney, 2/23/2024

Acknowledgments

Rangeland health reference sheet

Interpreting Indicators of Rangeland Health is a qualitative assessment protocol used to determine ecosystem condition based on benchmark characteristics described in the Reference Sheet. A suite of 17 (or more) indicators are typically considered in an assessment. The ecological site(s) representative of an assessment location must be known prior to applying the protocol and must be verified based on soils and climate. Current plant community cannot be used to identify the ecological site.

Author(s)/participant(s)	
Contact for lead author	
Date	05/18/2024
Approved by	Suzanne Mayne-Kinney
Approval date	
Composition (Indicators 10 and 12) based on	Annual Production

Indicators

1. **Number and extent of rills:**

2. **Presence of water flow patterns:**

3. **Number and height of erosional pedestals or terracettes:**

4. **Bare ground from Ecological Site Description or other studies (rock, litter, lichen, moss, plant canopy are not bare ground):**

5. **Number of gullies and erosion associated with gullies:**

6. **Extent of wind scoured, blowouts and/or depositional areas:**

7. **Amount of litter movement (describe size and distance expected to travel):**

8. **Soil surface (top few mm) resistance to erosion (stability values are averages - most sites will show a range of values):**

9. **Soil surface structure and SOM content (include type of structure and A-horizon color and thickness):**

10. **Effect of community phase composition (relative proportion of different functional groups) and spatial distribution on infiltration and runoff:**

11. **Presence and thickness of compaction layer (usually none; describe soil profile features which may be mistaken for compaction on this site):**

12. **Functional/Structural Groups (list in order of descending dominance by above-ground annual-production or live foliar cover using symbols: >>, >, = to indicate much greater than, greater than, and equal to):**

Dominant:

Sub-dominant:

Other:

Additional:

13. **Amount of plant mortality and decadence (include which functional groups are expected to show mortality or decadence):**

14. **Average percent litter cover (%) and depth (in):**

15. **Expected annual annual-production (this is TOTAL above-ground annual-production, not just forage annual-production):**

16. **Potential invasive (including noxious) species (native and non-native). List species which BOTH characterize degraded states and have the potential to become a dominant or co-dominant species on the ecological site if their future establishment and growth is not actively controlled by management interventions. Species that become dominant for only one to several years (e.g., short-term response to drought or wildfire) are not invasive plants. Note that unlike other indicators, we are describing what is NOT expected in the reference state for the ecological site:**

17. **Perennial plant reproductive capability:**
