

Ecological site R106XY083NE Saline Lowland

Last updated: 2/05/2019
Accessed: 04/29/2024

General information

Provisional. A provisional ecological site description has undergone quality control and quality assurance review. It contains a working state and transition model and enough information to identify the ecological site.

MLRA notes

Major Land Resource Area (MLRA): 106X–Nebraska and Kansas Loess-Drift Hills

Named the “Nebraska and Kansas Loess-Drift Hills,” Major Land Resource Area (MLRA) 106 is divided almost evenly between southeastern Nebraska (52%), and northeastern Kansas, (48%). The northern border is located on the north end of Saunders County, Nebraska, and the MLRA stretches into Douglas County, Kansas in the south. The Nebraska cities of Beatrice and Lincoln are the major population centers in the north, while Topeka and Lawrence in Kansas are the primary cities in the south. The approximately seven million-acre landscape covers all or parts of 30 counties between the two states. This dissected glacial drift plain primarily consists of broad, smooth ridgetops and slopes ranging from nearly level to steep. The elevation in MLRA 106 decreases from west to east, and ranges from nearly 1,650 feet to less than 790 feet above sea level. Stream valleys in this landscape are narrow and bordered by steep hills, with 10 to 20 feet of local relief. The river valleys are broader, and may drop up to over 160 feet below the adjacent hilltops. The Platte, Little Nemaha, and the North Fork of the Big Nemaha Rivers flow through the Nebraska side of the MLRA, while the Black Vermillion, the Soldier, and the Delaware Rivers are the major waterways on the Kansas side. The Big Blue River runs through both states, while The Salt Creek hydrologic system located near Lincoln, Nebraska provides habitat for the only known population of the Federally-listed endangered Tiger Salt Beetle.

The uplands are primarily comprised of glacial drift underlying a mantle of loess, while alluvial deposits are found in the stream and river valleys. Limestone and shale quarries are also located in MLRA 106. The predominant soil orders in this MLRA are mesic, udic, Mollisols, Alfisols, and Entisols. Loams and clays are the primary soil textures in this landscape.

Sixty-two percent of the land in this MLRA has been broken out of native prairie and farmed, while only 23 percent of the grasslands remain intact. Livestock grazing, primarily by cattle, is the main industry on these remnants. Corn, wheat, soybeans, and grain sorghum are the primary commodity crops, but a significant number of acres are also planted to alfalfa for harvest as hay.

With annual precipitation averaging from 40 inches in the southeast, to 28 inches in the northwest, irrigation for crop production is not a critical factor in most years.

The historical matrix vegetation type is Tallgrass Prairie, and big and little bluestem, switchgrass, Indiangrass, sideoats, and blue grama make up the bulk of the warm-season species; western wheatgrass is the dominant cool-season grass in the north, tall fescue is in the south. Large- and small-patch vegetative communities are found primarily along the riparian zones, and on both upland and lowland saline sites. Woodlands make up about six percent of MLRA 106, consisting primarily of green ash, oak, hackberry, boxelder, and maple trees.

Wildlife flourishes in this combination of crop and grassland environments. In a landscape historically occupied by bison herds, white-tailed deer are now the most abundant wild ungulates. A variety of smaller species, including coyote, raccoon, opossum, porcupines, muskrat, beaver, squirrel, and mink thrive in the region, as do several upland bird species. Native grassland bird populations are somewhat limited by the lack of contiguous native prairie and the fragmented habitat created by the farmland.

The rivers, streams, and lakes harbor excellent fisheries, and migrating and local waterfowl use the wetland complexes. These complexes provide ideal habitat for a number of wading and shore bird species as well. This landscape serves as a backdrop for a disturbance-driven ecosystem, evolving under the influences of herbivory, fire, and variable climate. Historically, these processes created a heterogeneous mosaic of plant

communities and structure heights across the region. Any given site in this landscape experienced fire every three to four years. The fires were caused by lightning strikes and also were set by Native Americans, who used fire for warfare, signaling, and to refresh the native grasses. The indigenous inhabitants understood the value of fire as a tool, and that the highly palatable growth following a fire provided excellent forage for their horses, and attracted grazing game animals such as bison and elk.

Land use patterns by post-European settlement have greatly altered the historical fire regime, allowing the expansion of the woody component. Introduction of eastern redcedar (ERC) as a windbreak species further facilitates invasion by this species.

While eastern redcedar is native to the landscape, the historic population in MLRA 106 was limited to isolated pockets in rugged river drainageways that were subsequently insulated from fire. Widespread plantings of windbreaks with eastern redcedar as a primary component have provided a seed source for the aggressive woody plant. The ensuing encroachment into the native grasslands degrades the native wildlife habit and causes significant forage loss for domestic livestock. However, since it is not a root-sprouter, eastern redcedar is very susceptible to fire when under six feet tall. Management with prescribed fire is exceedingly effective if applied before this stage. Larger redcedars can also be controlled with fire, but successful application requires the use of specifically-designed ignition and holding techniques.

Fragmentation of the native grasslands by conversion to cropland, transportation corridors, and other developments have effectively disrupted the natural fire regime of this ecosystem. This has allowed encroachment by native and introduced shrubs and trees into the remnants of the native prairie throughout the MLRA. Aggressive fire suppression policies have exacerbated this process to the point that shrub and tree encroachment is a major ecological issue in the majority of both native and reseeded grasslands.

Classification relationships

Major Land Resource Area (MLRA): 106 Major Land Resource Area (MLRA) (USDA-Natural Resources Conservation Service, 2006)

General information for MLRA 106:

Fenneman (1916) Physiographic Regions Division – Interior Plains
Province – Central Lowland
Section – Dissected Till Plains

USFS (2007) Ecoregions
Domain – Humid Temperate
Division – Prairie
Province – Prairie Parkland (Temperate)
Section – Central Dissected Till Plains (251C)

EPA Ecoregions (Omernik 1997)
I – Great Plains (9)
II – Temperate Prairies (9.2)
III – Western Corn Belt Plains (9.2.3)
IV – Loess and Glacial Drift Hills (47i)

Associated Counties
Nebraska: Butler, Cass, Gage, Jefferson, Johnson, Lancaster, Nemaha, Otoe, Pawnee, Richardson, Saline, Saunders, Seward

Kansas: Atchison, Brown, Doniphan, Douglas, Franklin, Jackson, Jefferson, Johnson, Leavenworth, Marshall, Nemaha, Osage, Pottawatomie, Shawnee, Wabaunsee, Washington, Wyandotte

Ecological site concept

The Saline Lowland site has an elevated salt content, and is located on slopes ranging from 1 to 8 percent. The historic vegetation community is a mixture of native tallgrasses and more salt-tolerant species. The depth to the water table during the growing season ranges from 36 to 60 inches.

Associated sites

R106XY065NE	Wet Subirrigated Wet Subirrigated- This site is lower on the landscape than Saline Lowland.
R106XY067NE	Saline Subirrigated Saline Subirrigated- This site is often adjacent to, but lower on the landscape than the Saline lowland site.

Similar sites

R106XY067NE	Saline Subirrigated Saline Subirrigated- This site has water at or near the surface, while Saline Lowland has a depth to water table of at least 36 inches.
R106XY070NE	Loamy Terrace Loamy Terrace- This site has a similar landscape position, but has no visible surface salts, and a more diverse and productive vegetative community.

Table 1. Dominant plant species

Tree	Not specified
Shrub	Not specified
Herbaceous	(1) <i>Pascopyrum smithii</i> (2) <i>Distichlis spicata</i>

Physiographic features

The Saline Lowland is a medium runoff site with negligible flooding or ponding. It is located on the footslopes and lower backslopes of dissected till plains, and also appears on the risers of stream terraces along river valleys.

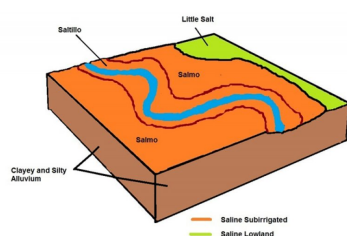

Figure 1.

Table 2. Representative physiographic features

Landforms	(1) Hill (2) Stream terrace
Flooding frequency	None to rare
Elevation	329–381 m
Slope	1–8%
Water table depth	91–152 cm
Aspect	Aspect is not a significant factor

Climatic features

Like most Great Plains landscapes, the climate in this MLRA is under the sway of the continental effect. This creates a regime of extremes, with summer highs often in the triple digits, and winter lows plunging well below zero. Blizzards can occur anytime between early fall and late spring, often dropping the temperature more than 50 degrees in just a few hours. These events can pile up several feet of snow, often driven by winds in excess of 50 miles an hour. The resulting huge snow drifts can cause serious hardship for livestock, wildlife, and humans. Winters can be open, with bare ground for most of the season, or closed, with up to several feet of snow persisting until March. Most winters have a number of warm days, interspersed with dropping temperatures, usually associated with approaching cold fronts. Spring brings violent thunderstorms, hail, and high winds. Tornadoes occur frequently.

About three-fourths of the precipitation falls as high-intensity, convective thunderstorms from late in spring through early in autumn.

The average annual precipitation gradient trends higher from northwest (28") to southeast (40"), and the average annual temperature gradient trends higher from north (50°F) to south (55°F).

Daily winds range from an average of 14 miles per hour during the spring to 11 miles per hour during the late summer. Occasional strong storms may bring brief periods of high winds with gusts to more than 80 miles per hour. Growth of native cool-season plants begins in early April and continues to about mid-June. Native warm-season plants begin growth in early June, and continue to early August. Green-up of cool-season plants may occur in September and October..

Table 3. Representative climatic features

Frost-free period (average)	159 days
Freeze-free period (average)	174 days
Precipitation total (average)	813 mm

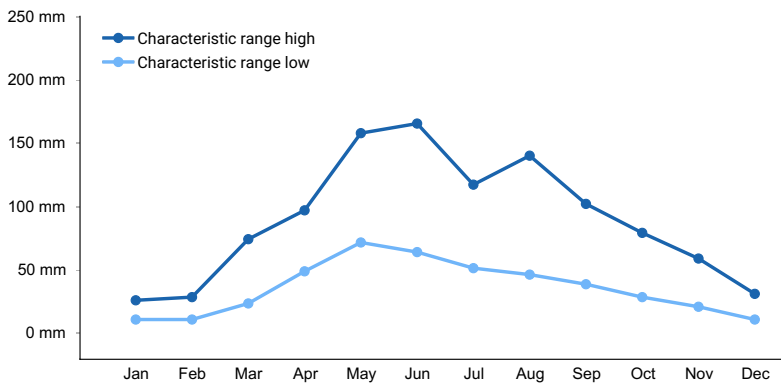

Figure 2. Monthly precipitation range

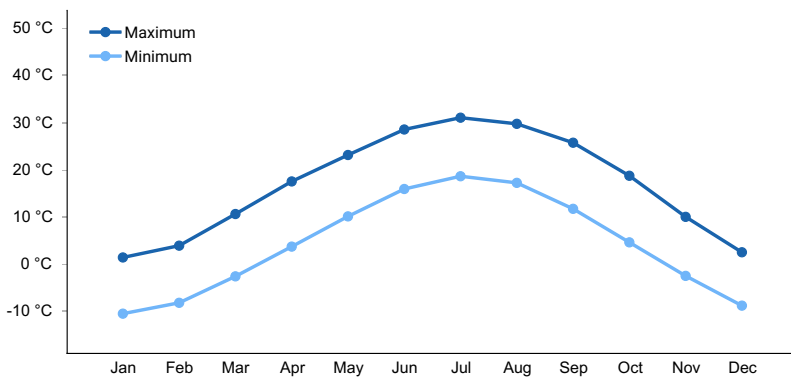

Figure 3. Monthly average minimum and maximum temperature

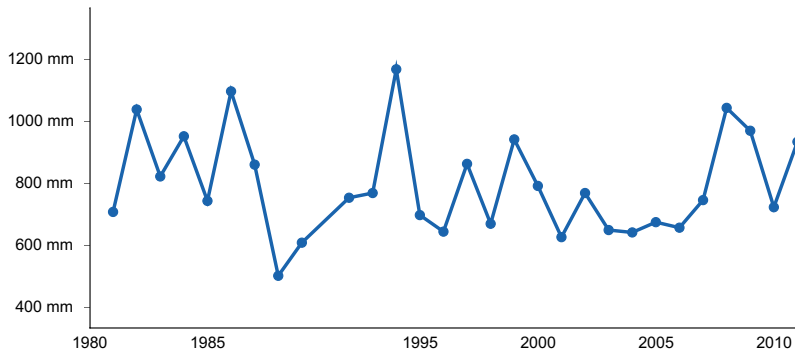

Figure 4. Annual precipitation pattern

Climate stations used

- (1) MEAD 6S [USC00255362], Ithaca, NE
- (2) RAYMOND 2NE [USC00257055], Raymond, NE
- (3) WEEPING WATER [USC00259090], Weeping Water, NE
- (4) LINCOLN MUNI AP [USW00014939], Lincoln, NE
- (5) WAHOO [USC00258905], Wahoo, NE
- (6) ASHLAND NO 2 [USC00250375], Ashland, NE
- (7) LINCOLN UNIV PWR PLT [USW00014971], Lincoln, NE

Influencing water features

This site receives runoff from sites in more elevated positions on the landscape, but isn't directly affected by the water table.

Soil features

The Saline Lowland site is found on soils that are very deep, moderately well drained, and formed in loess parent material that is high in exchangeable sodium. The site is positioned on the footslopes and lower backslopes of hillslopes and the dissected till plains. It is also found on terrace risers in the river valleys. The slopes range from 1 to 8 percent. The saturated hydraulic conductivity rate (K-sat) is classified as Low, which equates to a Very Slow permeability class. Little Salt is the only series correlated to this site.



Figure 6. Little Salt Soil Series Profile

Table 4. Representative soil features

Parent material	(1) Loess
Surface texture	(1) Silty clay loam

Drainage class	Moderately well drained
Permeability class	Very slow
Soil depth	0–203 cm
Available water capacity (0-101.6cm)	28.96–35.56 cm
Calcium carbonate equivalent (0-101.6cm)	0–2%
Electrical conductivity (0-101.6cm)	1–16 mmhos/cm
Sodium adsorption ratio (0-101.6cm)	13–50
Soil reaction (1:1 water) (0-101.6cm)	6.6–8.4

Ecological dynamics

Saline Lowland sites developed under Northern Great Plains climatic conditions, light to severe grazing by bison and other large herbivores, sporadic natural or man-caused wildfires, and other biotic and abiotic factors which typically influence soil/site development. This continues to be a disturbance-driven site, by herbivory, fire, and variable climate. Changes occur in the plant communities due to weather variations, impacts of native and/or exotic plant and animal species, and management actions.

The majority of this site has been impacted agricultural practices, both through soil disturbance and the accumulation of chemically contaminated run-off. A significant portion of the remaining acres have been degraded by season-long continuous grazing by domestic livestock. This management practice causes the repeated removal of the growing point and excessive defoliation of the leaf area of individual tall warm-season grasses. The resulting reduction of the ability of the plants to harvest sunlight depletes the root reserves, subsequently decreasing the root mass. This negatively impacts the ability of the plants to compete for life-sustaining nutrients, resulting in declining vigor and eventual mortality. The space created in the vegetative community is then occupied by a species that evades the negative grazing impacts by a growing season adaptation (such as a cool season), a shorter structure, or a reduced palatability mechanism.

The State-and-Transition Model (STM) is depicted below, and is made up of a Reference State, a Native/Invaded State, a Sod-busted State, and an Invaded Woody State. Each state represents the crossing of a major ecological threshold due to alteration of the functional dynamic properties of the ecosystem. The main properties observed to determine this change are the soil and vegetative communities and the hydrological cycle.

Each state may have one or more vegetative communities which fluctuate in species composition and abundance within the normal parameters of the state. Within each state, communities may degrade or recover in response to natural and man-caused disturbances such as variation in the degree and timing of herbivory, presence or absence of fire, and climatic and local fluctuations in the precipitation regime.

Interpretations are primarily based on the Reference State, and have been determined by study of rangeland relic areas, areas protected from excessive disturbance, and areas under long-term rotational grazing regimes. Trends in plant community dynamics have been interpreted from heavily grazed to lightly grazed areas, seasonal use pastures, and historical accounts. Plant communities, states, transitional pathways, and thresholds have been determined through similar studies and experience.

Growth of native cool-season plants begins about April 1, and continues to about June 15. Native warm-season plants begin growth about May 15, and continue to about August 15. Green-up of cool-season plants may occur in September and October if adequate moisture is available.

The following is a diagram illustrating the common plant communities that can occur on the site and the transition pathways between communities.

State and transition model

Ecosystem states

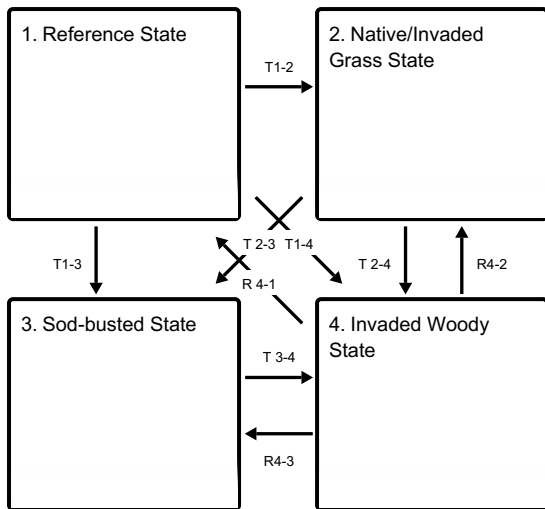

State 1 submodel, plant communities

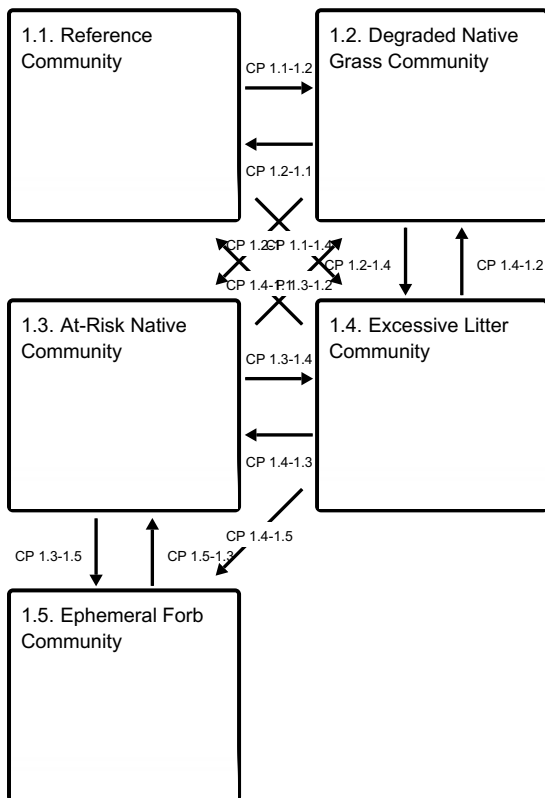

Communities 1, 5 and 2 (additional pathways)

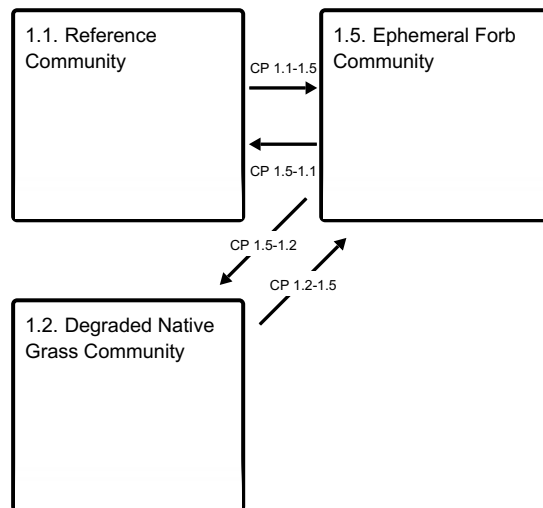

State 2 submodel, plant communities

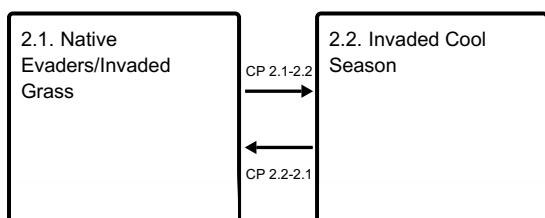

State 3 submodel, plant communities

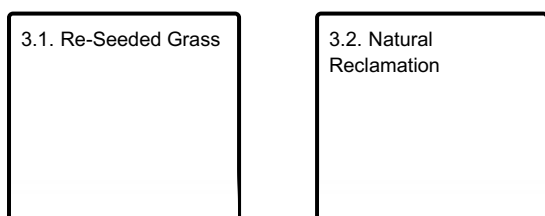

State 4 submodel, plant communities

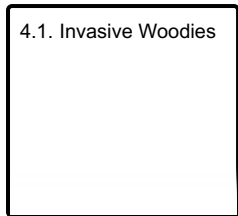

State 1 Reference State

This state describes the range of vegetative community phases that occur on the Saline Lowland site where the natural processes are mostly intact. The Reference Community is a representation of the native plant community phase that occupies a site that has been minimally altered by management. The Degraded Native Grass, the At-Risk Grass, and the Excessive Litter Communities are the phases that result from management decisions that are unfavorable for a healthy Reference Community. The Ephemeral Forb Community is the result of a high intensity disturbance event. High perennial grass cover and production allows for increased soil moisture retention, vegetative production, and overall soil quality.

Community 1.1 Reference Community

The Reference Community is comprised of salt-tolerant native prairie species, and serves as a description of the native plant community that naturally occurs on the site when the natural disturbance regimes are intact, or closely mimicked by management practices. This phase is dynamic, with fluid relative abundance and spatial boundaries between the dominant structural vegetative groups. These fluctuations are primarily driven by different responses of the species to changes in precipitation timing and abundance, and by fire and grazing events. The potential vegetation consists of approximately 70-85 percent grasses and grass-like plants, 5-15 percent forbs, and 0-5 percent shrubs. Switchgrass, western wheatgrass, and inland saltgrass are the primary species in this community. Secondary species include Indiangrass, slender wheatgrass, and blue grama. The site has a diverse forb population. This plant community is less productive than similar non-saline sites, and species diversity is somewhat limited as well. It is a resilient community, and resistant to short-term stresses such as drought and short periods of heavy stocking. The well-developed root systems support this resiliency when allowed adequate recovery periods between grazing events. When exposed to long-term or frequent over-grazing events without adequate rest, this plant community will degrade. Grazing during wet periods can cause excessive soil compaction, and lead to hummocking. The annual vegetative production of this community averages about 3,000 lbs. per acre.

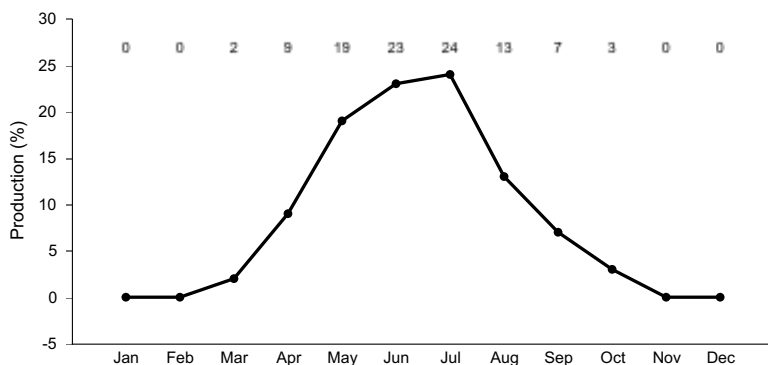

Figure 7. Plant community growth curve (percent production by month). NE1022, Warm-season dominant, cool-season subdominant.

Community 1.2 Degraded Native Grass Community

Switchgrass, Indiangrass, and other desirable species lose productive capacity through loss of vigor and reproductive potential. Forb diversity is reduced. The deep root systems of the tallgrasses on this site helps to sustain that component of the plant community. But as growing season defoliation continues, mid and shortgrasses such as western wheatgrass and inland saltgrass increase. Blue grama, Kentucky bluegrass and tall dropseed

begin to become apparent. This community phase signals a significant loss of production. The change is due to continuous season-long grazing with inadequate recovery periods. Grazing-evasive warm-season and cool-season grasses increase. The composition of the forb component favors less palatable species, and the potential for encroachment by invasive woody species becomes more likely. Fewer high bio-mass producing deep rooted species result in a reduced fire-friendly fuel load. While this plant community is less productive and less diverse than the representative plant community, the site/soil stability, watershed function, and biologic integrity remain sustainable.

Community 1.3 At-Risk Native Community

In this plant community, the more palatable warm-season tallgrasses have been reduced to remnant populations by continued defoliation during their critical growth periods. Grazing-evasive warm-season and cool-season grasses increase significantly. Blue grama, inland saltgrass, tall dropseed, smooth brome grass, and Kentucky bluegrass become dominant. Soil health is affected by reduced efficiency in the nutrient, mineral, and hydrologic cycles, which are a result of decreases in plant litter and rooting depths. This may result in formation of a compacted layer in the soil, and total annual vegetative production declines significantly. Without a management change, this community is at-risk to degrade to the Native/Invaded Grass State.

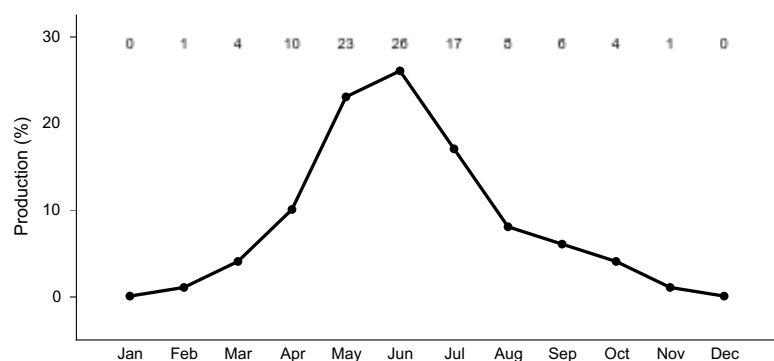

Figure 8. Plant community growth curve (percent production by month). NE1069, MLRA 106 Warm/cool-season mix.

Community 1.4 Excessive Litter Community

The Excessive Litter Community Phase describes the response of the community to the removal of the natural disturbances of herbivory and fire. As the undisturbed duff layer deepens, infiltration of the precipitation is interrupted and evaporation increases significantly, simulating drought-like conditions.

Community 1.5 Ephemeral Forb Community

This community describes the flush of forbs that occurs in response to a major disturbance, or combination of disturbances. Growing season wildfire followed by hail, extreme prolonged drought, or extreme defoliation by herbivores are all examples of these disturbances. The native warm-season grasses re-establish dominance within a few years of the event.

Pathway CP 1.1-1.2 Community 1.1 to 1.2

A shift from the reference Community to the Degraded Native Grass community occurs with continuous season long grazing and inadequate recovery periods during the growing season.

Pathway CP 1.1-1.4 Community 1.1 to 1.4

Prolonged interruption of the natural disturbances of herbivory and fire will result in conversion from this community

to the Excessive Litter Community.

Pathway CP 1.1-1.5
Community 1.1 to 1.5

A high-impact disturbance event or combination of events causing excessive defoliation of the vegetation, i.e. a growing season wildfire followed by a significant hailstorm, or a prolonged intensive grazing event or long-term drought, etc.

Pathway CP 1.2-1.1
Community 1.2 to 1.1

A shift from the Degraded Native Grass community toward the Reference community can be achieved through prescribed grazing. Applying grazing pressure during the growth period of the undesirable cool season grasses, and allowing rest during the warm season growing season favors our desired species. This grazing regime will enable the deeply rooted tall warm season grasses to out compete the shallow rooted grazing evasive warm season and the cool season grasses. Appropriately timed prescribed fire will accelerate this process.

Conservation practices

Prescribed Burning
Access Control
Prescribed Grazing

Pathway CP 1.2-1.3
Community 1.2 to 1.3

Maintaining continuous season long grazing or haying with inadequate recovery periods during the growing season further degrades the site to the At-Risk Grass Community.

Pathway CP 1.2-1.4
Community 1.2 to 1.4

Prolonged interruption of the natural disturbances of herbivory and fire will result in conversion from this community to the Excessive Litter Community.

Pathway CP 1.2-1.5
Community 1.2 to 1.5

A high-impact disturbance event, or combination of events causing excessive defoliation of the vegetation, i.e. a growing season wildfire followed by a significant hailstorm, or a prolonged intensive grazing event, or long-term drought, etc.

Pathway CP 1.3-1.2
Community 1.3 to 1.2

Reversing the downward trend to the previous community can be achieved with prescribed grazing early and late in the growing season to reduce undesirable cool season grasses. Targeting the peak growth period of cool season grasses with high intensity grazing events followed by rest will allow the tall native warm season grasses to rejuvenate. Appropriately timed prescribed fire will accelerate this process.

Conservation practices

Access Control
Prescribed Grazing

Pathway CP 1.3-1.4

Community 1.3 to 1.4

Prolonged interruption of the natural disturbances of herbivory and fire will result in conversion from this community to the Excessive Litter Community.

Pathway CP 1.3-1.5

Community 1.3 to 1.5

A high-impact disturbance event, or combination of events causing excessive defoliation of the vegetation, i.e. a growing season wildfire followed by a significant hailstorm, or a prolonged intensive grazing event, or long-term drought, etc.

Pathway CP 1.4-1.1

Community 1.4 to 1.1

Re-introduction of the natural processes of herbivory and fire will allow the vegetation to return to the previous community.

Conservation practices

Prescribed Burning

Prescribed Grazing

Pathway CP 1.4-1.2

Community 1.4 to 1.2

Re-introduction of the natural processes of herbivory and fire will allow the vegetation to return to the previous community.

Pathway CP 1.4-1.3

Community 1.4 to 1.3

Re-introduction of the natural processes of herbivory and fire will allow the vegetation to return to the previous community.

Pathway CP 1.4-1.5

Community 1.4 to 1.5

A high-impact disturbance event, or combination of events causing excessive defoliation of the vegetation, i.e. a growing season wildfire followed by a significant hailstorm, or a prolonged intensive grazing event, or long-term drought, etc.

Pathway CP 1.5-1.1

Community 1.5 to 1.1

Restoration occurs naturally once the disturbance event has subsided. Allowing growing season rest will accelerate the recovery.

Conservation practices

Access Control

Pathway CP 1.5-1.2

Community 1.5 to 1.2

Restoration occurs naturally once the disturbance event has subsided. Allowing growing season rest will accelerate

the recovery.

Conservation practices

Access Control

Pathway CP 1.5-1.3 Community 1.5 to 1.3

Restoration occurs naturally once the disturbance event has subsided. Allowing growing season rest will accelerate the recovery.

Conservation practices

Access Control

State 2 Native/Invaded Grass State

This state has been degraded from the Reference State and much of the native warm-season grass community has been replaced by less desirable plants. The loss of tall- and mid- warm-season grasses has negatively impacted energy flow and nutrient cycling. Water infiltration is reduced due to the shallow root system and rapid runoff characteristics of the grazing-evasive plant communities. The Native Evaders/Invasives and the Invaded Cool Season communities are the components of the Native/Invaded Grass State.

Community 2.1 Native Evaders/Invaded Grass

This plant community represents a shift from the Reference State across a plant community threshold. With continued grazing pressure, Kentucky bluegrass, smooth brome grass (tall fescue in the south) and dropseed will become the dominant plant species, with only trace remnants of the more palatable warm-season grasses such as blue and hairy grama. Continuous and heavy grazing pressure will maintain this plant community in a sod-bound condition. Forb richness and diversity has decreased. With the decline and loss of deeper-penetrating root systems, a compacted layer may form in the soil profile below the more shallow replacement root systems. Grazing management practices that allow for adequate periods of recovery between grazing events will favor mid- and tall-warm-season grasses. Appropriately-timed prescribed fire will accelerate the restoration process.

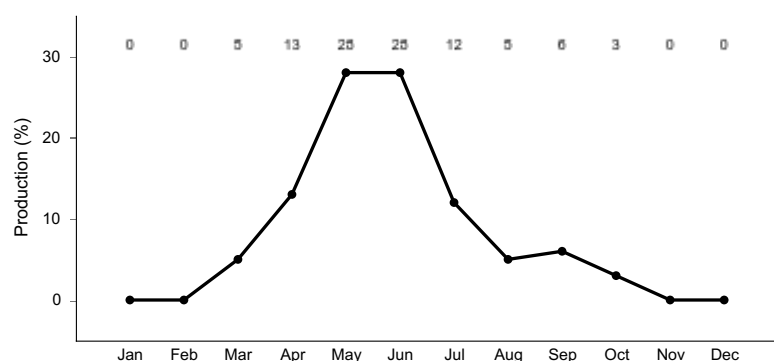

Figure 9. Plant community growth curve (percent production by month). NE1067, Nebraska and Kansas Loess Drift Hills. Invaded cool season dominant.

Community 2.2 Invaded Cool Season

This plant community contains predominately smooth brome grass, (tall fescue in the south), and Kentucky bluegrass. Some warm-season remnants are present. Production of cool-season-dominated plant communities is highly variable, depending upon the percentages of composition present and outside inputs such as fertilizer and

weed control. The previous growth curve also applies to this phase.

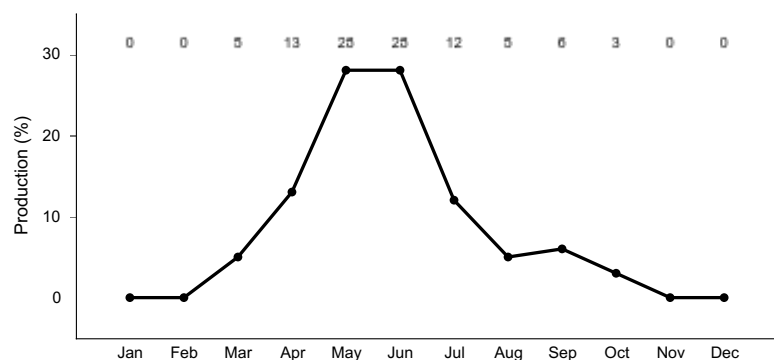

Figure 10. Plant community growth curve (percent production by month). NE1067, Nebraska and Kansas Loess Drift Hills. Invaded cool season dominant.

Pathway CP 2.1-2.2 Community 2.1 to 2.2

This community will be converted to a Reed canarygrass community through the following practices: introduced grass seeding, excessive warm season grazing, inadequate warm season rest, multi season haying and nitrogen fertilizing in spring and/or fall.

Pathway CP 2.2-2.1 Community 2.2 to 2.1

Restoration can be achieved by herbicide treatment and reseeded. If adequate native remnants are present, appropriately timed prescribed fire and a follow-up prescribed grazing program may achieve the desired results.

Conservation practices

Prescribed Burning
Access Control
Range Planting
Prescribed Grazing

State 3 Sod-busted State

This threshold is crossed as a result of mechanical disturbance to facilitate production agriculture. If farming operations are suspended, the site can be abandoned, which will result in the Naturally Reclaimed Community, or be re-seeded to a desired perennial forage mixture, which is described as the Re-seeded Community. Permanent alterations of the soil community and the hydrologic cycle make restoration to the original native Reference Community extremely difficult, if not impossible. Formation of a compacted plow pan in the soil profile is likely.

Community 3.1 Re-Seeded Grass

This plant community does not contain native remnants, and varies considerably depending on the seed mixture, the degree of soil erosion, the age of the stand, nitrogen fertilizer use, and past grazing management. Prescribed grazing with adequate recovery periods will be needed to maintain productivity and desirable species. Native range and seeded grasslands are ecologically different, and should be managed separately. Factors such as functional group, species, stand density, and improved varieties all impact the production level and palatability of the seedings. Species diversity is often limited, and when grazed in conjunction with native rangelands, uneven forage utilization may occur. Total annual production during an average year varies significantly depending on precipitation, management and grass species seeded.

Community 3.2

Natural Reclamation

This plant community consists of annual and perennial weeds and less desirable grasses. These sites have been farmed and abandoned without being reseeded. Soil organic matter/carbon reserves are reduced, soil structure is changed, and a plow-pan or compacted layer can be formed which decreases water infiltration. Residual synthetic chemicals may remain from farming operations. In early successional stages, this community is not stable. Erosion is a concern. Total annual production during an average year varies significantly depending on the succession stage of the plant community and any management applied to the system.

State 4

Invaded Woody State

Once the tree canopy cover reaches 15 percent with an average tree height exceeding 5 feet, the threshold is crossed to the Invaded Woody State. Woody species are encroaching due to lack of prescribed fire and other brush management practices. Typical ecological impacts are a loss of native warm season grasses, degraded forage productivity and reduced soil quality. This state consists of the Invasive Woodies Community.

Community 4.1

Invasive Woodies

This community has at least a 15 percent canopy of wooded cover. Locust, ash, elm, and dogwood are some of the deciduous invaders, while eastern redcedar is the primary evergreen encroacher. In the absence of fire and brush management, this site is very conducive to cedar seedling invasion, especially when adjacent to a seed source. Cedars can eventually dominate the site, resulting in a closed canopy monoculture which drastically reduces forage production and has limited value for either livestock grazing or wildlife habitat. Eastern redcedar control can usually be accomplished with prescribed burning while the trees are six feet tall or less and fine fuel production is over 1,500 pounds per acre. Trees of all heights can be controlled with the use of specifically adapted preparation, and ignition and holding techniques. Mechanical removal followed by a chemical treatment on stumps is effective on locust. Total annual production during an average year varies significantly, depending on the production level prior to encroachment and the percentage of canopy cover. Prescribed burning, wildfire, harvest, and brush management will move this plant community toward one of the herbaceous plant dominated plant communities. The forb component of a site with heavy tree density or canopy cover will initially increase following tree removal through mechanical brush management treatments and prescribed fire. Neither the Sod-busted State nor the Native/Invaded State can return to the Reference State through this process, as the native plant community, soils, and hydrological cycle have been too severely degraded. If re-sprouting brush such as Honey locust or Siberian elm is present, stumps must be chemically treated immediately after mechanical removal. Ongoing brush management such as hand cutting, chemical spot treatments or periodic prescribed burning is required to prevent a return to this state.

Transition T1-2

State 1 to 2

Heavy grazing or haying without adequate recovery periods will cause this state to lose a significant proportion of tall and mid- warm-season grass species and cross a threshold to the Native/Invaded State. Water infiltration and other hydrologic functions will be reduced due to the root matting presence of sod-forming grasses. With the decline and loss of deeper penetrating root systems, soil structure and biological integrity are catastrophically degraded to the point that recovery is unlikely. Once this occurs, it is highly unlikely that grazing management alone will return the community to the Reference State.

Transition T1-3

State 1 to 3

The Reference State is significantly altered by mechanical tillage to allow the site to be placed into production agriculture. The disruption to the plant community, the soil and the hydrology of the system make restoration to a true reference state unlikely.

Transition T1-4 **State 1 to 4**

Disruption of the natural fire regime and the planting of invasive exotic and native woody species can cause this state to shift to the Invaded Woody State.

Transition T 2-3 **State 2 to 3**

The state is significantly altered by mechanical tillage to allow the site to be placed into production agriculture. The disruption to the plant community, the soil and the hydrology of the system make restoration to a true reference state unlikely.

Transition T 2-4 **State 2 to 4**

Disruption of the natural fire regime and the planting of invasive exotic and native woody species can cause this state to shift to the Invaded Woody State.

Transition T 3-4 **State 3 to 4**

Disruption of the natural fire regime and the planting of invasive exotic and native woody species can cause this state to shift to the Invaded Woody State.

Restoration pathway R 4-1 **State 4 to 1**

Disruption of natural fire regime, planting of exotic and invasive native woody species. This can be reversed in all states by mechanical removal, immediate follow-up stump treatment of root-sprouting species. Development and implementation of a follow-up maintenance prescribed burn program is necessary to prevent re-invasion. States two and three cannot go back to state 1 through this process.

Conservation practices

Brush Management
Prescribed Burning
Prescribed Grazing

Restoration pathway R4-2 **State 4 to 2**

Disruption of natural fire regime, planting of exotic and invasive native woody species. This can be reversed in all states by mechanical removal, immediate follow-up stump treatment of root-sprouting species. Development and implementation of a follow-up maintenance prescribed burn program is necessary to prevent re-invasion. States two and three cannot go back to state 1 through this process.

Restoration pathway R4-3 **State 4 to 3**

Disruption of natural fire regime, planting of exotic and invasive native woody species. This can be reversed in all states by mechanical removal, immediate follow-up stump treatment of root-sprouting species. Development and implementation of a follow-up maintenance prescribed burn program is necessary to prevent re-invasion. States two and three cannot go back to state 1 through this process.

Additional community tables

Animal community

LIVESTOCK – GRAZING INTERPRETATIONS:

Grazing by domestic livestock, primarily cattle, is one of the primary uses of the native grasslands. During the dormant period, the protein levels of the forage may be lower than the minimum needed to meet livestock requirements. These sites are also hayed. Annual forage production of the Reference Community averages around 3,000 lbs./acre.

WILDLIFE INTERPRETATIONS:

Major Land Resource Area (MLRA) 106 lies primarily within the tallgrass prairie ecosystem. Prior to European settlement, this area consisted of diverse grassland habitats interspersed with varying densities of depressional wetlands and limited woody riparian corridors. These habitats provided critical life cycle components for the grassland birds, prairie dogs, and herds of roaming bison, elk, and pronghorn that historically occupied this landscape. Diverse populations of small mammals and insects provided a bountiful prey base for raptors and omnivores such as coyotes, foxes, raccoons, and opossums. Native Americans, bobcats, wolves, and mountain lions occupied the apex predator niche. In addition, a wide variety of reptiles and amphibians thrived in this landscape.

The tallgrass prairie was a disturbance-driven ecosystem with fire, herbivory, and climate functioning as the primary disturbances. Following European settlement, elimination of fire, widespread conversion to cropland, and other sources of habitat fragmentation significantly altered the appearance and functionality of the entire ecosystem. The reduced stability of the system is reflected by major changes in the composition and abundance of the native flora and fauna. Introduced and invading species further degrade the ecological integrity of the plant and animal communities. Bison and prairie dogs were historically keystone species, but free-roaming bison herds and nearly all prairie dogs have been extirpated. The loss of bison and fire as ecological drivers greatly influenced the character of the remaining native grasslands and the habitats that they provide. Fragmentation has reduced habitat quality for numerous area-sensitive species, as highlighted by the decline of the greater prairie chicken. Many grassland-nesting bird populations, such as dickcissel and Henslow's sparrow, are also declining. In addition to free-ranging bison, extirpated species include pronghorn and wolves.

Historically, an ecological mosaic of the sites provided habitat for species requiring unfragmented grasslands. Important habitat features and components found commonly or exclusively on modern day remnants include upland nesting habitat for grassland birds and game birds; nesting and escape cover for waterfowl; forbs and insects for brood-rearing habitat; and a forage source for small and large herbivores.

In this fragmented landscape, native grassland bird populations face increasing competition from the opportunistic European starlings and house sparrows, and are subject to nest parasitism from brown-headed cowbirds. Tree encroachment creates habitat that favors generalist species such as American robin and mourning dove, and provides perches for raptors, increasing the predation mortality.

Introduced species such as smooth brome grass, reed canarygrass, Kentucky bluegrass, nodding plumeless thistle, and Canada thistle further degrade the biological integrity of many of these remnant prairies.

1. REFERENCE STATE: The predominance of mixed grasses and forbs in this community makes it ideal for grazers and mixed-feeders. Pollinating insects play a large role in maintaining the forb community, and provide a food source for grassland birds and other grassland-dependent species. The vegetative structural diversity provides habitat for reptiles, amphibians, and a wide array of native and introduced bird species. The abundant prey base supports populations of Swainson's hawk, short-eared and great horned owls, and other grassland raptors. The grasses, forbs, and shrubs provide high nutrition levels for small and large herbivores including moles, mice, ground squirrels, and whitetail deer. The structure of this plant community provides suitable thermal, protective, and escape cover for small herbivores and grassland birds. Many wide-ranging predators utilize this plant community, including coyote, badger, red fox, and least- and long-tailed weasels.

As the plant community degrades, less winter and escape cover are provided. It also provides less cover for predators.

Hydrological functions

The very deep, moderately well drained soils correlated to the Saline Lowland site place it in category D of the hydrologic rating scale.

The depth to water allows the deeper rooted tallgrass species access to during the growing season, but the salinity of the site somewhat limits production and species diversity.

Recreational uses

This site provides hunting for upland game species and white-tailed deer, along with hiking, photography, and bird watching. The wide varieties of plants which bloom from spring until fall have an aesthetic value that appeals to visitors.

Wood products

The Saline Lowland ecological site does not normally produce a significant amount of wood products.

Other products

None of significance.

Other information

Site Development and Testing Plan:

Future work is needed to validate the information in this Provisional Ecological Site Description. Additional data collection and evaluation may also be needed to develop this ESD to the Approved, then Correlated level. This could include field activities to collect low-, medium-, and high-intensity sampling, soil correlations, and analysis of that data. Field reviews of the project plan should be done by soil scientists and vegetation specialists. A final field review, peer review, quality control, and quality assurance reviews of the ESD will be needed to produce the final document.

Inventory data references

Information presented here has been derived from field observations by trained and experienced range and soils personnel.

Other references

Other References

Harms, R. 2009. Recovery Outline for the Salt Creek tiger beetle (*Cicindela nevadica lincolniana*). Available online. <http://www.fws.gov/mountain-prairie/species/invertebrates/saltcreektiger/FinalRecoveryOutlineFeb2009.pdf>. Accessed 1/02/2018.

High Plains Regional Climate Center, University of Nebraska. Available online. <http://hpcc.unl.edu>. Accessed 12/05/16.

Johnsgaard, P.A. 2001. "The Nature of Nebraska." University of Nebraska Press.

Muhs, Daniel R., E. Bettis III, J. Aleinikoff, J. McGeehin, J. Beann, G. Skipp, B. Marshall, H. Roberts, W. Johnson, and R. Benton.

"Origin and paleoclimatic significance of late Quaternary loess in Nebraska: Evidence from stratigraphy, chronology, sedimentology, and geochemistry" (2008). USGS Staff -- Published Research, Paper 162. Available online. <http://digitalcommons.unl.edu/usgsstaffpub/162>. Accessed 12/05/16.

Spomer, S. and L. Higley. 2001. The Salt Creek Tiger Beetle. Bio-graphica International. Available online. <http://drshigley.com/lgh/sctb/default.htm>. Accessed 1/02/2018.

U.S. Dept. of Agriculture. NRCS National Ecological Site Handbook. Available online.

<https://www.nrcs.usda.gov/wps/portal/nrcs/detailfull/soils/ref/?cid=nrcseprd1291232> Accessed January, 2014.

U.S. Dept. of Agriculture. NRCS National Engineering Handbook, Section 4. Available online. <https://directives.sc.egov.usda.gov/viewerFS.aspx?hid=21422>.

Accessed August, 2011.

Contributors

Doug Whisenhunt

Approval

David Kraft, 2/05/2019

Acknowledgments

I would like to express my appreciation for all of the work done by the Soils Team, the Local Practitioners Team, the Technical Team, the editor, and the QC and QA folks.

Non-discrimination Statement

In accordance with Federal civil rights law and U.S. Department of Agriculture (USDA) civil rights regulations and policies, the USDA, its Agencies, offices, and employees, and institutions participating in or administering USDA programs are prohibited from discriminating based on race, color, national origin, religion, sex, gender identity (including gender expression), sexual orientation, disability, age, marital status, family/parental status, income derived from a public assistance program, political beliefs, or reprisal or retaliation for prior civil rights activity, in any program or activity conducted or funded by USDA (not all bases apply to all programs). Remedies and complaint filing deadlines vary by program or incident.

Persons with disabilities who require alternative means of communication for program information (e.g., Braille, large print, audiotope, American Sign Language, etc.) should contact the responsible Agency or USDA's TARGET Center at (202) 720-2600 (voice and TTY) or contact USDA through the Federal Relay Service at (800) 877-8339. Additionally, program information may be made available in languages other than English.

To file a program discrimination complaint, complete the USDA Program Discrimination Complaint Form, AD-3027, available online and at any USDA office, or write a letter addressed to USDA and provide in the letter all of the information requested in the form. To request a copy of the complaint form, call (866) 632- 9992. Submit your completed form or letter to USDA by: (1) mail: U.S. Department of Agriculture, Office of the Assistant Secretary for Civil Rights, 1400 Independence Avenue, SW, Washington, D.C. 20250-9410; (2) fax: (202) 690-7442; or (3) email: program.intake@usda.gov.

Rangeland health reference sheet

Interpreting Indicators of Rangeland Health is a qualitative assessment protocol used to determine ecosystem condition based on benchmark characteristics described in the Reference Sheet. A suite of 17 (or more) indicators are typically considered in an assessment. The ecological site(s) representative of an assessment location must be known prior to applying the protocol and must be verified based on soils and climate. Current plant community cannot be used to identify the ecological site.

Author(s)/participant(s)	
Contact for lead author	
Date	
Approved by	
Approval date	
Composition (Indicators 10 and 12) based on	Annual Production

Indicators

1. **Number and extent of rills:**

2. **Presence of water flow patterns:**

3. **Number and height of erosional pedestals or terracettes:**

4. **Bare ground from Ecological Site Description or other studies (rock, litter, lichen, moss, plant canopy are not bare ground):**

5. **Number of gullies and erosion associated with gullies:**

6. **Extent of wind scoured, blowouts and/or depositional areas:**

7. **Amount of litter movement (describe size and distance expected to travel):**

8. **Soil surface (top few mm) resistance to erosion (stability values are averages - most sites will show a range of values):**

9. **Soil surface structure and SOM content (include type of structure and A-horizon color and thickness):**

10. **Effect of community phase composition (relative proportion of different functional groups) and spatial distribution on infiltration and runoff:**

11. **Presence and thickness of compaction layer (usually none; describe soil profile features which may be mistaken for compaction on this site):**

12. **Functional/Structural Groups (list in order of descending dominance by above-ground annual-production or live foliar cover using symbols: >>, >, = to indicate much greater than, greater than, and equal to):**

Dominant:

Sub-dominant:

Other:

Additional:

13. **Amount of plant mortality and decadence (include which functional groups are expected to show mortality or decadence):**

14. **Average percent litter cover (%) and depth (in):**

15. **Expected annual annual-production (this is TOTAL above-ground annual-production, not just forage annual-production):**

16. **Potential invasive (including noxious) species (native and non-native). List species which BOTH characterize degraded states and have the potential to become a dominant or co-dominant species on the ecological site if their future establishment and growth is not actively controlled by management interventions. Species that become dominant for only one to several years (e.g., short-term response to drought or wildfire) are not invasive plants. Note that unlike other indicators, we are describing what is NOT expected in the reference state for the ecological site:**

17. **Perennial plant reproductive capability:**
