

Ecological site F113XY910IL

Fragic Backslope Woodland

Last updated: 5/17/2024
Accessed: 05/21/2024

General information

Provisional. A provisional ecological site description has undergone quality control and quality assurance review. It contains a working state and transition model and enough information to identify the ecological site.

MLRA notes

Major Land Resource Area (MLRA): 113X–Central Claypan Areas

The eastern Illinois portion of the Central Claypan Areas MLRA is in the Till Plains Section of the Central Lowland Province of the Interior Plains (USDA-NRCS, 2006) and includes the Southern Till Plain Natural Division of the natural divisions of Illinois (Schwegman, 1973; 1997; IDNR, 2018) in south-central Illinois. South-central Illinois is a dissected Illinoian till plain south of the terminal Wisconsin moraine. This region consists of nearly level to gently sloping, old till plains. Stream valleys are shallow and generally are narrow. Elevation is about 660 feet (200 meters), increasing gradually from south to north. Local relief is generally low on the broad, flat till plains and flood plains and high on the dissected hills bordering rivers or drainage systems. The Kaskaskia, Little Muddy, Little Wabash, Embarras, and Saline Rivers are part of this area. This region is covered with loess, which overlies old glacial drift (Illinoian till) that has a high content of clay. Fragipans are also present. Pennsylvanian limestone and shale bedrock underlay the glacial till. The dominant soil orders in this region are Alfisol and Mollisol. The soils in the area predominantly have a mesic soil temperature regime, an aquic or udic soil moisture regime, and mixed or smectitic mineralogy. They generally are very deep, well drained to poorly drained, and loamy or clayey. (USDA-NRCS, 2006).

Classification relationships

Major Land Resource Area (MLRA) (USDA-NRCS, 2006):
113 – Central Claypan Areas, Eastern Part

U.S. Forest Service Ecoregions (Cleland et al. 2007):

Domain: Humid Temperate Domain

Division: Hot Continental Division

Province: Eastern Broadleaf Forest (Continental)

Province Code: 222

Section: Central Till Plains, Oak-Hickory Section

Section Code: 222G

Ecological site concept

This woodland community type is found in south-central Illinois in the Central Claypan Areas MLRA. Fragic Backslope ecological sites are found on convex backslopes along drainageways in dissected uplands along transitional areas between broad summit ecological sites and steeper hillslope ecological sites. They formed in loess and the underlying silty or loamy deposits that overlie a strongly developed paleosol with a shallow to moderately deep fragipan.

The historic reference plant community was a woodland dominated by drought and fire-tolerant post oak (*Quercus stellata* Wangenh.)¹ and black oak (*Quercus velutina* Lam.) and hickory species (*Carya* spp.), including shagbark hickory (*Carya ovata* (Mill.) K. Koch) and mockernut hickory (*Carya tomentosa* (Lam.) Nutt.) (White, 1978). Saplings

of sassafras (*Sassafras albidum* (Nutt.) Nees) and black cherry (*Prunus serotina* Ehrh.) may be present. The herbaceous layer probably contained a fairly diverse mix of prairie and woodland flora, with prairie grasses, such as little bluestem (*Schizachyrium scoparium* (Michx.) Nash), abundant. Few sites remain on which to describe this type, and historically, it may have been maintained by frequent fires (NatureServ, 2017). McClain et al. (1999) note that this type occurs in the post oak flatwoods region of Illinois, but stands of this type lack the micro-depressions typical of post oak flatwoods, nor do they contain the typical indicators of the xero-hydric conditions of flatwoods, such as sweet woodreed (*Cinna arundinacea* L.).

Woodlands were distinguished from forest, by their relatively open understory, and the presence of sun-loving ground flora species (White, 1994). Fire was the primary disturbance factor that maintained this ecological site, while drought, windthrow, and grazing were secondary factors (LANDFIRE 2009).

1 All plant common and scientific names in this document were obtained from the U.S. Department of Agriculture – Natural Resources Conservation Service National PLANTS Database (USDA NRCS, 2018).

Associated sites

R113XY904IL	Upland Prairie Prairie ecological site often upslope but on dark colored somewhat poorly drained soils associated with nearly level till plains.
F113XY911IL	Loamy Till Backslope Forest A backslope woodland ecological site on loess over till loamy soils that is sometimes mapped in a complex with Fragic Backslope Woodlands.

Similar sites

F113XY907IL	Fragic Till Plain Woodland Fragic Till Plain Woodland ecological sites are upslope, also support an oak-hickory woods, but poorer drainage results in a wetter environment that is less productive with more moisture tolerant species in the understory.
-------------	---

Table 1. Dominant plant species

Tree	(1) <i>Quercus stellata</i> (2) <i>Quercus velutina</i>
Shrub	(1) <i>Rhus aromatica</i>
Herbaceous	(1) <i>Schizachyrium scoparium</i> (2) <i>Desmodium</i>

Physiographic features

This site is on convex backslopes along drainageways in dissected uplands with slopes of 5 to 18 percent. The site generates runoff to adjacent, downslope ecological sites. This site does not flood.

Table 2. Representative physiographic features

Landforms	(1) Upland > Ground moraine (2) Upland > Till plain (3) Upland > Loess hill (4) Upland > Ridge
Runoff class	Medium to high
Elevation	107–305 m
Slope	5–18%
Water table depth	76–97 cm
Aspect	W, NW, N, NE, E, SE, S, SW

Climatic features

The soil temperature regime of MLRA 113 is classified as mesic, where the mean annual soil temperature is between 47 and 59°F. Temperature and precipitation occur along a north-south gradient, where temperature and precipitation increase the further south you travel (USDA-NRCS 2006). The majority of the precipitation occurs as rainfall in the form of convective thunderstorms during the growing season.

Table 3. Representative climatic features

Frost-free period (characteristic range)	159-162 days
Freeze-free period (characteristic range)	183-186 days
Precipitation total (characteristic range)	1,168-1,219 mm
Frost-free period (actual range)	158-163 days
Freeze-free period (actual range)	182-186 days
Precipitation total (actual range)	1,118-1,219 mm
Frost-free period (average)	161 days
Freeze-free period (average)	185 days
Precipitation total (average)	1,194 mm

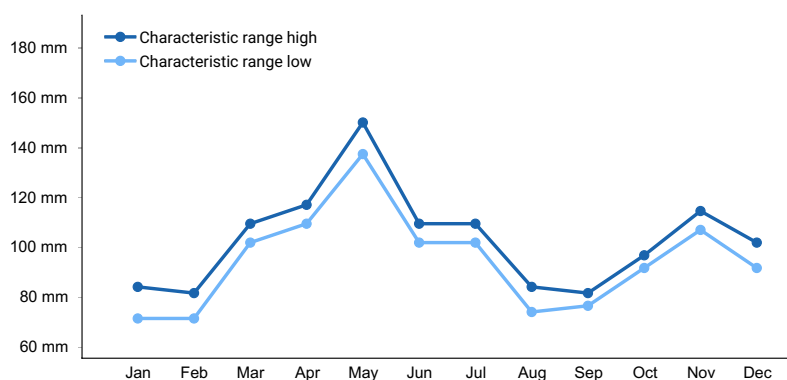

Figure 1. Monthly precipitation range

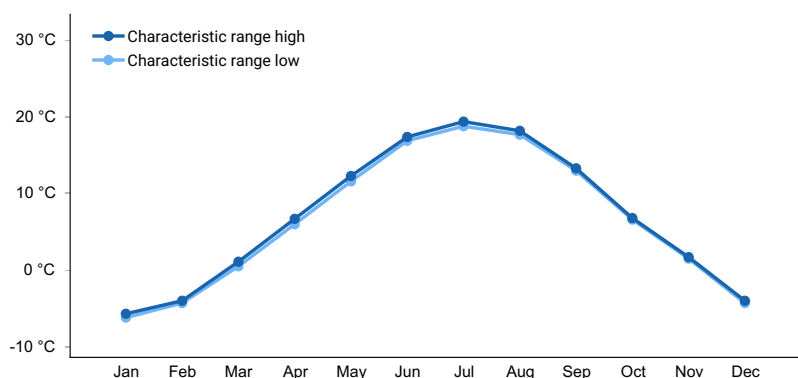

Figure 2. Monthly minimum temperature range

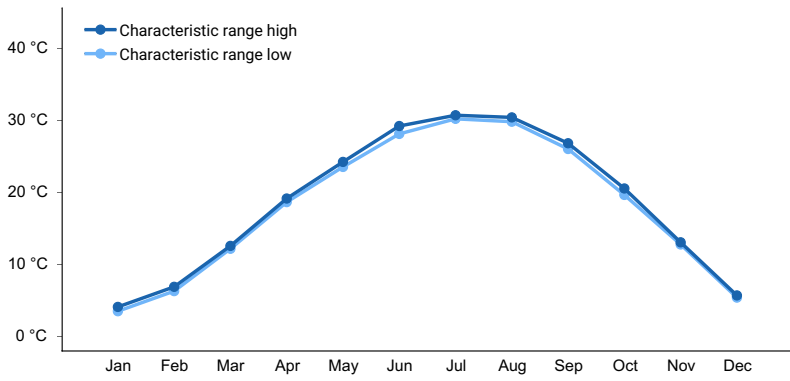

Figure 3. Monthly maximum temperature range

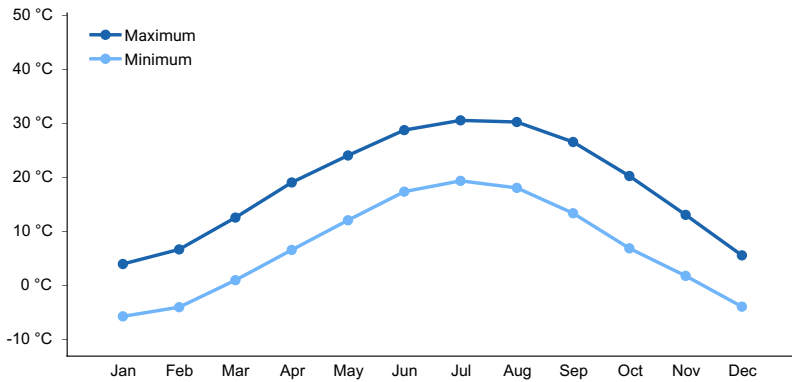

Figure 4. Monthly average minimum and maximum temperature

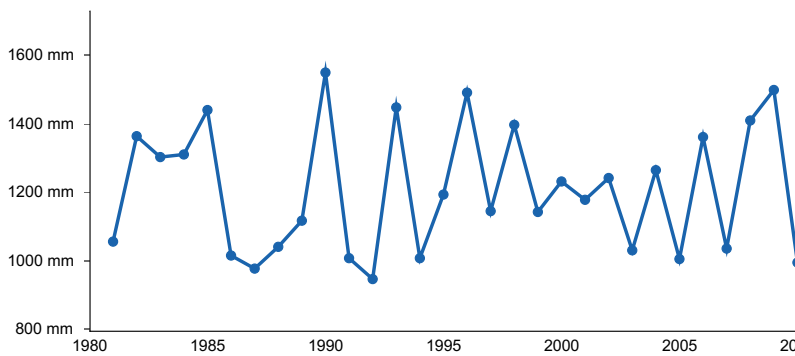

Figure 5. Annual precipitation pattern

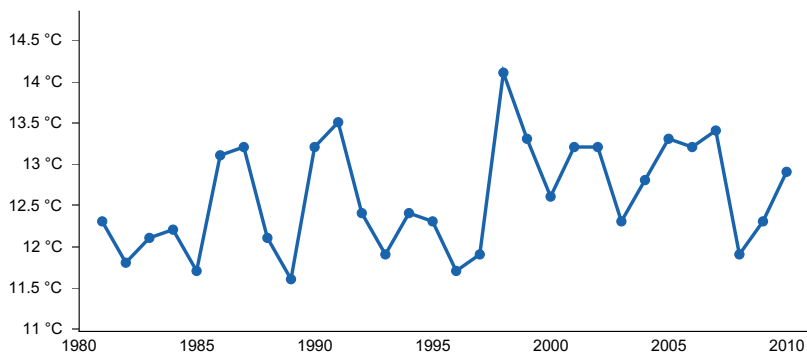

Figure 6. Annual average temperature pattern

Climate stations used

- (1) CARMI 3 [USC00111302], Carmi, IL
- (2) MARION 4 NNE [USC00115342], Marion, IL
- (3) OLNEY 2S [USC00116446], Olney, IL

- (4) MT VERNON 3 NE [USC00115943], Mount Vernon, IL

Influencing water features

Fragic Backslope Woodlands are not influenced by wetland or riparian water features. However, a seasonal zone of saturation occurs, perched on the fragipan in the subsoil. Precipitation is the main source of water for this ecological site. Infiltration is slow, and surface runoff is high (SSS NRCS WSS, 2018). Surface runoff contributes water to downslope ecological sites. These areas have a fragipan with a very slow rate of water transmission through the pan. There is a perched, seasonal water table is at a depth of about 30 inches from December through April in most years. (SSS NRCS OSD, 2018).

Soil features

These soils have a root-restricting fragipan at 12 to 33 inches. They formed in loess and the underlying silty or loamy deposits that overlie a strongly developed paleosol or underlying weathered materials of interbedded sandstone, shale, and siltstone. They have thin, light-colored, silt loam surface horizons, and silt loam, silty clay loam or sandy clay loam subsoils. They are very strongly acid to neutral. A seasonal high water table is perched above the fragipan during the spring months in most years. Soils of this ecological site are in the Alfisol order, further classified as fine-silty, mixed, active, mesic (Oxyaquic or Aquic) Fragiudalfs. Soil series associated with this site include Ava, Grantsburg, Plumfield, and Zanesville (NCSS, 2018; SSS NRCS OSD, 2018).

Table 4. Representative soil features

Parent material	(1) Loess (2) Till
Surface texture	(1) Silt loam (2) Silty clay loam
Drainage class	Moderately well drained
Permeability class	Very slow to slow
Depth to restrictive layer	30–84 cm
Soil depth	183 cm
Surface fragment cover <=3"	0%
Surface fragment cover >3"	0%
Available water capacity (Depth not specified)	5.08–20.32 cm
Electrical conductivity (Depth not specified)	0–2 mmhos/cm
Sodium adsorption ratio (Depth not specified)	0–5
Soil reaction (1:1 water) (Depth not specified)	4.5–7.3
Subsurface fragment volume <=3" (Depth not specified)	0–3%
Subsurface fragment volume >3" (Depth not specified)	0%

Ecological dynamics

The MLRA lies within the transition zone between the eastern deciduous forests and the tallgrass prairies. The heterogeneous topography of the area results in variable microclimates and fuel matrices that in turn are able to support prairies, savannas, woodlands, and forests. Fragic Backslope Woodlands form an aspect of this vegetative continuum. This ecological site occurs on convex slopes along drainageways in dissected uplands with slopes of 5 to 18 percent on soils that have a root-restricting fragipan. These woodlands ranged from open savannas near the prairie edge to open, park-like woodlands farther away (Anderson, 1975; Brugam et.al., 2016; Coates, 1992; Edgin,

1996, 2002, 2003; Anderson et.al., 2007; Taft et.al., 1994). Species characteristic of this ecological site consist of an open canopy of oaks and hickories with a continuous understory of herbaceous vegetation.

Fire is a critical factor that maintains Fragic Backslope Woodlands. Fire typically consisted of low- to moderate-severity surface fires every 2 to 5 years ((Anderson, 1975; Brugam et.al., 2016; LANDFIRE 2009). Ignition sources included summertime lightning strikes from convective storms and bimodal, human ignitions during the spring and fall seasons. Native Americans regularly set fires to improve sight lines for hunting, drive large game, improve grazing and browsing habitat, agricultural clearing, and enhance vital ethnobotanical plants (Barrett 1980; LANDFIRE 2009).

Drought, grazing, and windthrow have also played a role in shaping this ecological site. Wet Clayey Till Backslope Woodland ecological sites were also subjected to occasional disturbances from wind and ice, as well as grazing by native large herbivores, such as bison (*Bos bison*), prairie elk (*Cervus elaphus*), and white-tailed deer (*Odocoileus virginianus*). Wind and ice would have periodically opened the canopy up by knocking over trees or breaking substantial branches off canopy trees. Grazing by large native herbivores would have effectively kept understory conditions more open, creating conditions more favorable to oak reproduction and woodland ground flora species (Anderson, 1982; Irland 2000; Peterson 2000). When coupled with fire, periods of drought, herbivory, and high wind events can greatly delay the establishment and maturation of woody vegetation (Pyne et al. 1996).

Extensive conversion for agriculture has fragmented this system. These ecological sites are moderately productive. Today, many of these ecological sites have been cleared and converted to pasture or has been maintained in woody cover with increased stand density. Uncontrolled domestic grazing has also impacted these remaining woodland communities, further diminishing the diversity of native plants and introducing species that are tolerant of grazing, such as coralberry (*Symphoricarpos orbiculatus* Moench), gooseberry (*Ribes* spp.), and Virginia creeper (*Parthenocissus quinquefolia* (L.) Planch.).

Grazed sites also have a more open understory. In addition, soil compaction and soil erosion can be a problem and lower productivity. In the long term absence of fire, woody species, especially hickory (*Carya* spp.) and hophornbeam (*Ostrya virginiana* (Mill.) encroach into these woodlands (IDNR, 2018). Once established, these woody plants can quickly fill the existing understory increasing shade levels with a greatly diminished ground flora (Dey and Kabrick, 2015). Remaining woodland ecological sites have a younger (50 to 80 years) canopy layer whose species composition and quality has been altered by timber harvesting practices.

A provisional state and transition diagram is depicted in Figure 2. Detailed descriptions of each state, transition, plant community, and pathway follow the model. This model is based on available experimental research, field observations, professional consensus, and interpretations. It may change as knowledge increases.

State and transition model

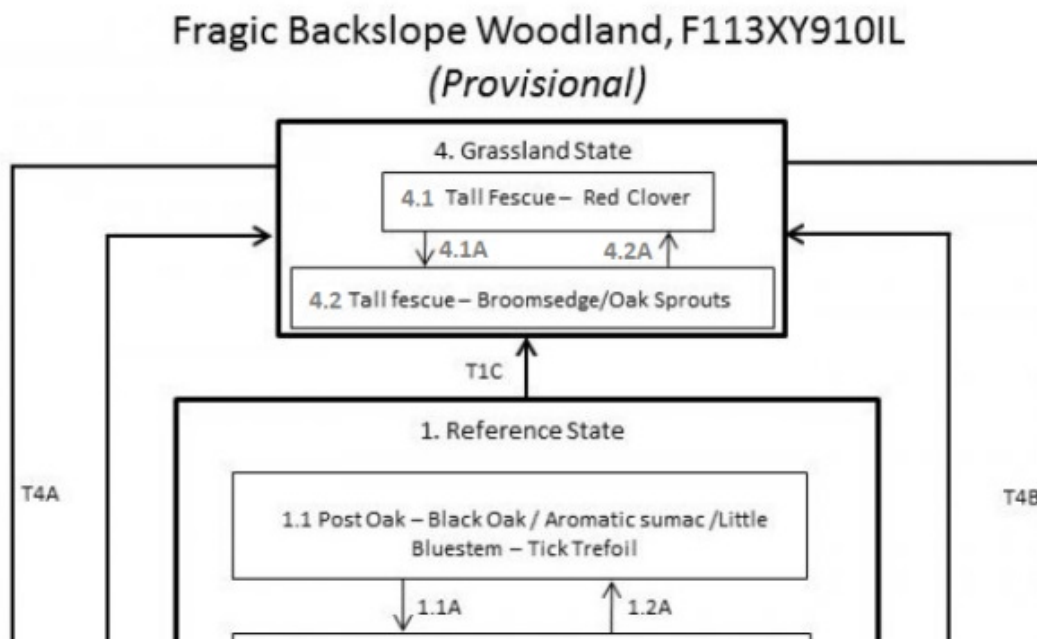

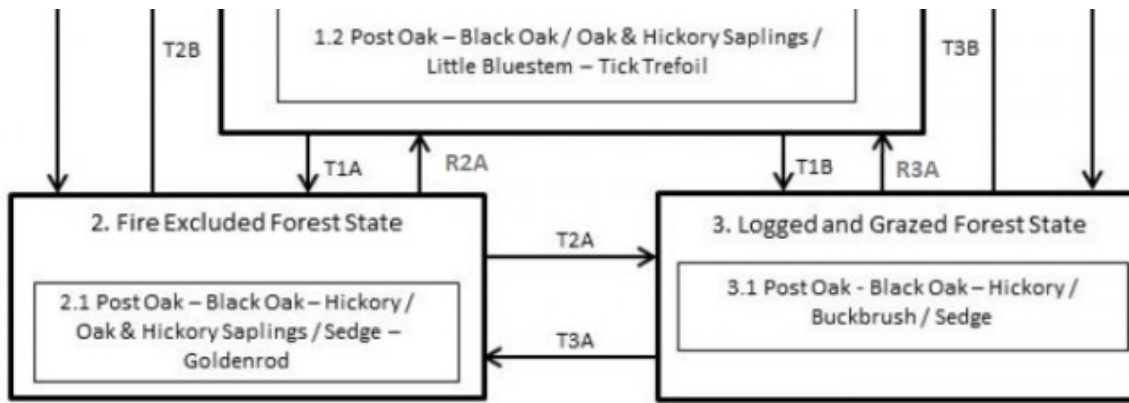

Code	Event/Activity/Process
T1A	Fire suppression; timber harvests
T1B	Fire suppression; high grading timber harvests; uncontrolled domestic grazing
T1C, T2B	Clearing; grassland planting; grassland management
T2A	Uncontrolled domestic grazing; high grading timber harvests
T3A	Exclude domestic grazing; forest stand improvement
T4B	Long-term woody encroachment; grazing; high-grading timber harvests
T4A	Tree planting; long-term succession; grazing exclusion

Code	Event/Activity/Process
1.1A	Fire-free interval, 5-10 years
1.2A	Fire 2-5 years
5.1A	Over grazing; no fertilization
5.2A	Brush management; prescribed grazing

Code	Event/Activity/Process
R1A	Exclude domestic grazing; forest stand improvement; prescribed fire 2-5 years; tree planting
R1B	Forest stand improvement; prescribed fire 2-5 years

State 1 Reference

These open woodland reference communities were strongly influenced by fire. Herbivory by native (now expatriated) ungulates also played a role. Consequently, drought and fire-tolerant post oak and black oak over a ground flora of tallgrass prairie grasses, sedges and wildflowers made up this woodland. There are two phases associated with this reference state.

Dominant plant species

- post oak (*Quercus stellata*), tree
- black oak (*Quercus velutina*), tree
- fragrant sumac (*Rhus aromatica*), shrub
- little bluestem (*Schizachyrium scoparium*), grass
- ticktrefoil (*Desmodium*), other herbaceous

Community 1.1

Post Oak – Black Oak /Aromatic Sumac/ Little Bluestem – Tick Trefoil

The overstory in this phase is dominated by post oak and black oak, with scattered blackjack oak (*Quercus marilandica* Münchh.) and mockernut hickory. This open woodland community typically has a two-tiered structure, with canopy height of 40 to 60 feet and 50 to 70 percent closure. The abundant herbaceous layer is dominated by little bluestem. Fire frequency was every 2 to 5 years. This continued fire and natural native grazing would have maintained the more open canopy and profusion of ground flora species.

Community 1.2

Post Oak – Black Oak / Oak & Hickory Saplings / Little Bluestem – Tick Trefoil

The overstory in this phase is dominated by post oak and black oak, with scattered blackjack oak and mockernut hickory. This brushy woodland community typically has a three-tiered structure, with 50 to 80 percent closure. It is characterized by a thick understory of oak and hickory saplings, and shrubs. The herbaceous layer is reduced but still dominated by little bluestem. Fire-free intervals ranged from 5 to 20 years.

Pathway 1.1A

Community 1.1 to 1.2

Fire-free interval, 5-10 years

Pathway 1.2A

Community 1.2 to 1.1

Prescribed fire 2-5 years

State 2

Fire Excluded Forest

Most current areas of Fragic Backslope Woodlands have experienced fire exclusion for decades. In the absence of fire, ongoing recruitment of trees into the canopy develops a closed canopy, shading out the rich herbaceous ground flora. This results in the formation of Post Oak – Black Oak – Hickory / Oak & Hickory Saplings / Goldenrod forests. Black oak and midstory species increase. Herbaceous cover and diversity greatly diminishes, leaf litter builds up, and more shade-tolerant woodland species persist, such as goldenrods (*Solidago* spp.), panic grasses (*Dichanthelium* spp.) and asters (*Symphotrichum* spp.). The understory also develops with oak and hickory saplings along with sassafras and black cherry.

Dominant plant species

- post oak (*Quercus stellata*), tree
- black oak (*Quercus velutina*), tree
- hybrid hickory (*Carya*), tree
- sedge (*Carex*), grass
- goldenrod (*Solidago*), other herbaceous

State 3

Logged and Grazed Forest

Although many of the closed Fragic Backslope Woodlands are now fenced, most have been heavily grazed by domestic livestock at some point in their history. Grazing decreases the cover and abundance of saplings, shrubs and herbaceous ground flora, opening up the understory. Weedy native shrubs and vines, such as coralberry (*Symphoricarpos orbiculatus* Moench), gooseberry (*Ribes* spp.), poison ivy (*Toxicodendron radicans* (L.) Kuntze) and Virginia creeper (*Parthenocissus quinquefolia* (L.) Planch.), often flourish after grazing, and exotic species like fescue and sericea lespedeza increase in abundance. Poorly managed grazing can cause compaction and denudation of the soil surface. Soil compaction may also further limit height growth of trees. With poorly managed grazing, this can result in an increase in weedy natives such as sedges (*Carex* spp.), and exotics such as sericea

lespedeza (*Lespedeza cuneata* (Dum. Cours.) G. Don) if they are present. Single-tree timber harvesting also occurred, resulting in a high grading of the canopy structure, creating many stands with poor quality trees.

Dominant plant species

- post oak (*Quercus stellata*), tree
- black oak (*Quercus velutina*), tree
- hybrid hickory (*Carya*), tree
- coralberry (*Symphoricarpos orbiculatus*), shrub
- currant (*Ribes*), shrub
- eastern poison ivy (*Toxicodendron radicans*), shrub
- Virginia creeper (*Parthenocissus quinquefolia*), other herbaceous

State 4

Grassland

Conversion of woodland to planted, non-native grassland species such as tall fescue (*Schedonorus arundinaceus* (Schreb.) Dumort., nom. cons.) and red clover (*Trifolium pratense* L.) has been common occurrence. Clearing is often done by bulldozing and burning. This practice often strips the thin topsoil along with most of the native ground cover plants. Occasionally, clumps of trees will be left in small groves for shade, giving the structural appearance of historic woodlands. A return from this condition to a woodland state requires enormous cost and management inputs.

Dominant plant species

- tall fescue (*Schedonorus arundinaceus*), grass
- red clover (*Trifolium pratense*), other herbaceous

Community 4.1

Tall Fescue – Red Clover

Planted, non-native grassland species such as tall fescue (*Schedonorus arundinaceus* (Schreb.) Dumort., nom. cons.) and red clover (*Trifolium pratense* L.) are commonly used.

Community 4.2

Tall fescue – Broomsedge/Oak Sprouts

Overtime oak without disturbance oak establishes in the plant community.

Pathway 4.1A

Community 4.1 to 4.2

Over grazing; no fertilization

Pathway 4.2A

Community 4.2 to 4.1

Brush management; prescribed grazing; grassland management

Transition T1A

State 1 to 2

Fire suppression; timber harvests

Transition T1B

State 1 to 3

Fire suppression; high grading timber harvests; uncontrolled domestic grazing

Transition T1C

State 1 to 4

Clearing; grassland planting; grassland management

Restoration pathway R2A

State 2 to 1

Forest stand improvement; prescribed fire 2-5 years

Transition T2A

State 2 to 3

Uncontrolled domestic grazing; high grading timber harvests

Transition T2B

State 2 to 4

Clearing; grassland planting; grassland management

Restoration pathway R3A

State 3 to 1

Exclude domestic grazing; forest stand improvement; prescribed fire 2-5 years; tree planting

Transition T3A

State 3 to 2

Exclude domestic grazing; forest stand improvement

Transition T3B

State 3 to 4

Clearing; grassland planting; grassland management

Transition T4A

State 4 to 2

Tree planting; long-term succession; grazing exclusion

Transition T4B

State 4 to 3

Long-term woody encroachment; grazing; high-grading timber harvests

Additional community tables

Inventory data references

No field plots were available for this site. A review of the scientific literature and professional experience were used to approximate the plant communities and ecological dynamics for this provisional ecological site. Information for the state-and-transition model was obtained from the same sources. All community phases are considered provisional based on the sources identified in ecological site description.

References

- Anderson, R.C. and M.R. Anderson. 1975. The presettlement vegetation of Williamson County, Illinois.. *Castanea* 40:345–363.
- Anderson, R.C. 1982. An evolutionary model summarizing the roles of fire, climate, and grazing animals in the origin and maintenance of grasslands. Pages 297–308 in , , and , editors. *Grasses and grasslands: systematics and ecology*.
- Anderson R. C., J. S. Fralish, and J. M. Baskin. 2007. Presettlement forests of Illinois. G. V. Burger, J. E. Ebinger, and G. S. Wilhelm, eds., *Proceedings of the Oak Woods Management Workshop* 9–19.
- Barrett, S.W. 1980. Indians and fire.. *Western Wildlands* 17–20.
- Briggs, J.M., A.K. Knapp, and B.L. Brock. 2002. Expansion of woody plants in tallgrass prairie: a fifteen- year study of fire and fire-grazing interactions. *The American Midland Naturalist* 147:287–294.
- Brinson, M.M. 1993. A hydrogeomorphic classification for wetlands.
- Brugam, R.B., P.D. Kilburn, and L.L. Luecking. 2016. Pre-settlement Vegetation of Greene, Jersey and Macoupin Counties along the Prairie/Forest Border in Illinois.. *Transactions of the Illinois State Academy of Science* 109:9–17.
- Cleland, D.T., J.A. Freeouf, J.E. Keys, G.J. Nowacki, C. Carpenter, and W.H. McNab. 2007. *Ecological Subregions: Sections and Subsections of the Coterminous United States*. USDA Forest Service, General Technical Report WO-76. Washington, DC. 1–92.
- Coates, D.T., K.J. Lyman, and J.E. Ebinger. 1992. Woody vegetation structure of a post oak flatwoods in Illinois.. *Castanea* 57:196–201.
- Comer, P.J., D. Faber-Langendoen, R. Evans, S. Gawler, C. Josse, G. Kittel, S. Menard, M. Pyne, M. Reid, K. Schulz, K. Snow, and J. Teague. 2003 (Date accessed). *Ecological Systems of the United States: A Working Classification of U.S. Terrestrial Systems*.
- Cowardin, L.M., V. Carter, F.C. Golet, and E.T. LaRoe. 1979. *Classification of wetlands and deep water habitats of the United States..* U.S. Dept. of Interior, Fish & Wildlife Service, Office of Biological Services, Washington DC. FWS/OBS-79/31 1–142.
- Dey, D.C. and J.M. Kabrick. 2015. Restoration of Midwestern oak woodlands and savannas.. Pages 401–428 in *Restoration of Boreal and Temperate Forests, Second Edition*. CRC Press, Boca Raton, Florida, USA..
- Edgin, B. 1996. Barrens of pre-settlement Lawrence County, Illinois.. Pages 59–65 in *Proceedings of the 15th North American Prairie Conference*.
- Edgin, B. and J.E. Ebinger. 1997. Barrens and the pre-settlement prairie/forest interface in Crawford County, Illinois.. *Castanea* 62:260–267.
- Edgin, B., R. Beadles, and J.E. Ebinger. 2002. *Woody Composition and Structure of Karcher's Post Oak Woods*

- Nature Preserve, Hamilton County, Illinois.. Transactions of the Illinois State Academy of Science 95:251–259.
- Edgin B., W. E. McClain, R. Gillespie, and J. E. Ebinger. 2003. Vegetation composition and structure of Eversgerd Post Oak Flatwoods, Clinton County, Illinois.. Northeast Naturalist 10:111–118.
- Illinois Department of Natural Resources (IDNR). March 2018 (Date accessed). Natural Divisions - Southern Till Plain..
- Irland, L.C. 2000. Ice storms and forest impacts.. The Science of the Total Environment 262:231–242.
- Kilburn, P. and R.B. Brugam. 2014. Inventory of Vegetation Studies in Illinois Based on the Public Land Survey Records.. Transactions of the Illinois State Academy of Science 107:13–17.
- USGS. 2009 (Date accessed). Landfire National Vegetation Dynamics Models.
<http://www.LANDFIRE.gov/index.php>.
- Mohlenbrock R. H. and D. M. Ladd. 1978. Distribution of Illinois Vascular Plants. Southern Illinois Univ. Press, Carbondale and Edwardsville, IL. 281p.
- Mohlenbrock R. H. 2003. Vascular Flora of Illinois. Vascular Flora of Illinois, 3rd edition. Southern Illinois University Press, Carbondale, Illinois. 1–736.
- National Cooperative Soil Survey (NCSS). 2018 (Date accessed). National Cooperative Soil Characterization Database. <https://ncsslabsdatamart.sc.egov.usda.gov/>.
- National Oceanic and Atmospheric Administration (NOAA). 2018 (Date accessed). Climate Data 1980-2010. <https://www.ncdc.noaa.gov/data-access/land-based-station-data/find-station>.
- NatureServe. 2018 (Date accessed). Association Detail Report: CEG002427 . <http://explorer.natureserve.org>.
- Nelson, P. 2010. The Terrestrial Natural Communities of Missouri. Revised edition. Missouri Natural Areas Committee, Department of Natural Resources and the Department of Conservation, Jefferson City. 549p.
- Pyne, S.J., P.L. Andrews, and R.D. Laven. 1996. Introduction to Wildland Fire, Second Edition. Introduction to Wildland Fire, Second Edition. John Wiley and Sons, Inc. New York, New York. 1–808.
- Schwegman, J.E., G.B. Fell, M.D. Hutchinson, G. Paulson, W.M. Shephard, and J. White. 1973. The natural divisions of Illinois. Comprehensive plan for the Illinois Nature Preserve system. Part 2. Illinois Nature Preserves Commission, Rockford, IL 1–32.
- . 2018 (Date accessed). Web Soil Survey (SSS NRCS WSS) . <https://websoilsurvey.sc.egov.usda.gov/>.
- SSS NRCS OSD and . 2018 (Date accessed). Official Soil Series Descriptions.
<https://soilseries.sc.egov.usda.gov/osdname.aspx>.

Taft, J.B., M.W. Schwartz, and L.R. Philippe. 1995. Vegetation ecology of flatwoods on the Illinoian till plain. *Journal of Vegetation Science* 6:647–666.

United States Department of Agriculture, . 2006. Land resource regions and major land resource areas of the United States, the Caribbean, and the Pacific Basin... *USDA Handbook 296* 1–682.

USDA, N. 2018 (Date accessed). The PLANTS Database. <http://plants.usda.gov>.

Voigt J. W. and R. H. Mohlenbrock. 1964. Plant communities of southern Illinois. *Plant communities of southern Illinois*. Southern Illinois University Press, Carbondale 1–202.

White J. 1978. Natural Areas Inventory Technical Report. *Natural Areas Inventory Technical Report: Volume I, Survey Methods and Results*. Illinois Natural Areas Inventory, Department of Landscape Architecture, University of Illinois at Urbana/Champaign 1–426.

White, J. and M. Madany. 1978. Classification of natural communities in Illinois (Appendix 30). In J. White, *Illinois Natural Areas Inventory Technical Report. Volume 1: Survey Methods and Results*. Illinois Natural Areas Inventory, Department of Landscape Architecture, University of Illinois at Urbana/Champaign. 310–405.

Other references

Relationship to other established ecological classifications:

Biophysical Setting (LANDFIRE, 2009); the reference community of this ecological site is also similar to: North-Central Interior Wet Flatwoods (CES202.700)

National Vegetation Classification System (NatureServe, 2018): the reference community of this ecological site is most similar to: Central Tallgrass Post Oak Woodland; *Quercus stellata* - *Quercus velutina* / *Schizachyrium scoparium* Woodland (Post Oak - Black Oak / Little Bluestem Woodland); CEGL005281.

Illinois Natural Areas Survey (INAS) (White, 1978); the reference community of this ecological site is most similar to: INAS Community Class – Forest; Natural community – Southern Flatwoods

Contributors

Douglas Wallace
Ralph Tucker
Zach Weber

Approval

Suzanne Mayne-Kinney, 5/17/2024

Acknowledgments

Contact information for primary authors: Ralph Tucker (ralph.tucker@mo.usda.gov), Soil Scientist, United States Department of Agriculture - Natural Resources Conservation Service (USDA-NRCS), Union, MO; Zach Weber (zach.weber@il.usda.gov), Soil Scientist, USDA-NRCS, Olney, IL; Douglas Wallace (doug.wallace@mo.usda.gov), Ecologist, USDA-NRCS, Columbia, MO.

Rangeland health reference sheet

Interpreting Indicators of Rangeland Health is a qualitative assessment protocol used to determine ecosystem

condition based on benchmark characteristics described in the Reference Sheet. A suite of 17 (or more) indicators are typically considered in an assessment. The ecological site(s) representative of an assessment location must be known prior to applying the protocol and must be verified based on soils and climate. Current plant community cannot be used to identify the ecological site.

Author(s)/participant(s)	
Contact for lead author	
Date	05/21/2024
Approved by	Suzanne Mayne-Kinney
Approval date	
Composition (Indicators 10 and 12) based on	Annual Production

Indicators

1. **Number and extent of rills:**

2. **Presence of water flow patterns:**

3. **Number and height of erosional pedestals or terracettes:**

4. **Bare ground from Ecological Site Description or other studies (rock, litter, lichen, moss, plant canopy are not bare ground):**

5. **Number of gullies and erosion associated with gullies:**

6. **Extent of wind scoured, blowouts and/or depositional areas:**

7. **Amount of litter movement (describe size and distance expected to travel):**

8. **Soil surface (top few mm) resistance to erosion (stability values are averages - most sites will show a range of values):**

9. **Soil surface structure and SOM content (include type of structure and A-horizon color and thickness):**

10. **Effect of community phase composition (relative proportion of different functional groups) and spatial distribution on infiltration and runoff:**

11. **Presence and thickness of compaction layer (usually none; describe soil profile features which may be mistaken for compaction on this site):**

12. **Functional/Structural Groups (list in order of descending dominance by above-ground annual-production or live foliar cover using symbols: >>, >, = to indicate much greater than, greater than, and equal to):**

Dominant:

Sub-dominant:

Other:

Additional:

13. **Amount of plant mortality and decadence (include which functional groups are expected to show mortality or decadence):**

14. **Average percent litter cover (%) and depth (in):**

15. **Expected annual annual-production (this is TOTAL above-ground annual-production, not just forage annual-production):**

16. **Potential invasive (including noxious) species (native and non-native). List species which BOTH characterize degraded states and have the potential to become a dominant or co-dominant species on the ecological site if their future establishment and growth is not actively controlled by management interventions. Species that become dominant for only one to several years (e.g., short-term response to drought or wildfire) are not invasive plants. Note that unlike other indicators, we are describing what is NOT expected in the reference state for the ecological site:**

17. **Perennial plant reproductive capability:**
