

Ecological site R115XA102IL

Dry Sand Dunes

Last updated: 12/30/2024
Accessed: 01/09/2025

General information

Provisional. A provisional ecological site description has undergone quality control and quality assurance review. It contains a working state and transition model and enough information to identify the ecological site.

MLRA notes

Major Land Resource Area (MLRA): 115X–Central Mississippi Valley Wooded Slopes

This MLRA is characterized by deeply dissected, loess-covered hills bordering well defined valleys of the Illinois, Mississippi, Missouri, Ohio, and Wabash Rivers and their tributaries. It is used to produce cash crops and livestock. About one-third of the area is forested, mostly on the steeper slopes. This area is in Illinois (50 percent), Missouri (36 percent), Indiana (13 percent), and Iowa (1 percent) in two separate areas. It makes up about 25,084 square miles (64,967 square kilometers).

Most of this area is in the Till Plains section and the Dissected Till Plains section of the Central Lowland province of the Interior Plains. The Springfield-Salem plateaus section of the Ozarks Plateaus province of the Interior Highlands occurs along the Missouri River and the Mississippi River south of the confluence with the Missouri River. The nearly level to very steep uplands are dissected by both large and small tributaries of the Illinois, Mississippi, Missouri, Ohio, and Wabash Rivers. The Ohio River flows along the southernmost boundary of this area in Indiana. Well defined valleys with broad flood plains and numerous stream terraces are along the major streams and rivers. The flood plains along the smaller streams are narrow. Broad summits are nearly level to undulating. Karst topography is common in some parts along the Missouri and Mississippi Rivers and their tributaries. Well-developed karst areas have hundreds of sinkholes, caves, springs, and losing streams. In the St. Louis area, many of the karst features have been obliterated by urban development.

Elevation ranges from 90 feet (20 meters) on the southernmost flood plains to 1,030 feet (320 meters) on the highest ridges. Local relief is mainly 10 to 50 feet (3 to 15 meters) but can be 50 to 150 feet (15 to 45 meters) in the steep, deeply dissected hills bordering rivers and streams. The bluffs along the major rivers are generally 200 to 350 feet (60 to 105 meters) above the valley floor.

The uplands in this MLRA are covered almost entirely with Peoria Loess. The loess can be more than 7 feet (2 meters) thick on stable summits. On the steeper slopes, it is thin or does not occur. In Illinois, the loess is underlain mostly by Illinoian-age till that commonly contains a paleosol. Pre-Illinoian-age till is in parts of this MLRA in Iowa and Missouri and to a minor extent in the western part of Illinois. Wisconsin-age outwash, alluvial deposits, and sandy eolian material are on some of the stream terraces and on dunes along the major tributaries. The loess and glacial deposits are underlain by several bedrock systems. Pennsylvanian and Mississippian bedrock are the most extensive. To a lesser extent are Silurian, Devonian, Cretaceous, and Ordovician bedrock. Karst areas have formed where limestone is near the surface, mostly in the southern part of the MLRA along the Mississippi River and some of its major tributaries. Bedrock outcrops are common on the bluffs along the Mississippi, Ohio, and Wabash Rivers and their major tributaries and at the base of some steep slopes along minor streams and drainageways.

The uplands in this area support natural hardwoods. Oak, hickory, and sugar maple are the dominant species. Big bluestem, little bluestem, and scattered oak and eastern redcedar grow on some sites. The soils on flood plains support mixed forest vegetation, mainly American elm, eastern cottonwood, river birch, green ash, silver maple, sweetgum, American sycamore, pin oak, pecan, and willow. Sedge and grass meadows and scattered trees are on some low-lying sites. (United States Department of Agriculture, Natural Resources Conservation Service, 2022)

LRU notes

Most of this LRU (Land Resource Unit) is in the glaciated Till Plains Section of the Central Lowland Province of the Interior Plains. The southeast corner is in the Highland Rim Section (locally known as the Shawnee Hills Section) of the Interior Low Plateaus Province of the Interior Plains. The nearly level to very steep uplands in this LRU are dissected by both large and small tributaries of the Wabash and Ohio Rivers. Well defined valleys with broad flood plains and numerous stream terraces are along the major streams and rivers. The flood plains along the smaller streams are narrow. Broad summits are nearly level to gently sloping.

This area is covered almost entirely with Wisconsin loess, also known as Peoria loess. The loess can be more than 7 feet (2 meters) thick on stable summits. On the steeper slopes, it is thin or does not occur. The loess throughout the area is underlain dominantly by glacial till. Wisconsin outwash, alluvial deposits, and sandy eolian material are on some of the stream terraces and on dunes along the major tributaries in the area. The loess and glacial drift are underlain by Pennsylvanian-age bedrock. Bedrock outcrops are common in the walls of the valleys along the Wabash and Ohio Rivers and at the base of some steep slopes along minor streams and drainageways.

The dominant soil orders in this LRU are Alfisols, Entisols, Inceptisols, and Mollisols. The soils in the area have a mesic soil temperature regime, a udic or aquic soil moisture regime, and dominantly mixed or smectitic mineralogy. The soils are very deep, poorly drained to excessively drained, and loamy, silty, or clayey. Nearly level Endoaqualfs (Iva series) and Argiaquolls (Ragsdale series) formed in loess on broad upland summits and flats. Nearly level to steep Hapludalfs (Alford, Iona, Muren, Stoy, and Sylvan series) and Fragiudalfs (Hosmer series) formed in loess on uplands. Hapludalfs (Alvin, Bloomfield, and Princeton series) and Argiudolls (Ade series) formed in sandy eolian material in areas of dunes on uplands and stream terraces. Steep and very steep Hapludalfs (Hickory series) formed in Illinoian till along the major streams and dissected upland drainageways. Hapludalfs (Wellston series) formed in siltstone or sandstone residuum on strongly sloping to steep side slopes underlain by bedrock.

The soils in the major stream valleys include Hapludolls (Carmi series), Argiudolls (Elston series), and Hapludalfs (Skelton series), all of which formed in outwash on nearly level to moderately sloping stream terraces and outwash plains. Endoaquolls (Montgomery series), Endoaquepts (Zipp series), Epiaqualfs (McGary series), and Hapludalfs (Shircliff and Markland series) formed in clayey lacustrine sediments on nearly level to strongly sloping lacustrine terraces or lake plains. Endoaquepts (Evansville series), Endoaquolls (Patton series), and Hapludalfs (Henshaw and Uniontown series) formed in silty sediments on terraces and lake plains.

LRU notes (excerpts from Land resource regions and major land resource areas of the United States, the Caribbean, and the Pacific Basin. USDA Handbook 296, 2006)

Classification relationships

Major Land Resource Area (MLRA) 115X—Central Mississippi Valley Wooded Slopes

U.S. Forest Service Ecoregions (Cleland et al. 2007):

Domain: Humid Temperate Domain

Division: Hot Continental Division

Province: Eastern Broadleaf Forest (Continental)

Province Code: 222

Section Code: 222G, 222D

Ecological site concept

These sites are located on dry sand dunes, and soils are somewhat excessively to excessively drained. Available water capacity for these soils is low and ranges from 3-4 inches. Slopes range from 2-12%, so vegetative communities on these sites will show variation and will be influenced by slope and aspect.

The historic reference community was a native woodland community with scattered occurrence of dry-tolerant tree species including post oak (*Q. stellata*), southern red oak (*Q. falcata*), black oak (*Quercus velutina*), black hickory (*Carya texana*), and sand hickory (*Q. pallida*). Other species may be present including sassafras (*Sassafras albidum*), shagbark hickory (*Carya ovata*), and red maple (*Acer rubrum*). The shrub layer on sites is highly variable

depending on fire frequency, slope, and aspect.

This open canopy, fire-dependent woodland, contained a ground layer with many native prairie and woodland species including Indian grass (*Sorghastrum nutans*), little bluestem (*Schizachyrium scoparium*), poverty oat grass (*Danthonia spicata*), white wand beardtongue (*Penstemon tubaeflorus*), hairy false goldenaster (*Heterotheca villosa*), white mouth dayflower (*Commelina erecta* var. *angustifolia*), poppymallow (*Callirhoe* spp.), sedges (*Carex* spp.), geraniums (*Geranium* spp.) and asters (*Aster* spp.).

Drought and fires interacted to maintain the open characteristic of this community. Regular fire was the main influence on these sites and with a reduction of fire frequency, these sites will transition to a woodland with associated drought tolerant herbaceous and grass species. Lack of fire will allow for an increase in shrubs, tree saplings, and more shade tolerant understory; however, the lack of water on these sites, especially in drought years, will limit tree growth and survival.

Today, most remaining wooded sites are a mix of deciduous trees. Community composition will depend on the severity and frequency of disturbances.

Associated sites

R115XA103IL	Sand Dunes These sites are also on sandy soils but are well drained.
R115XA101IL	Wet Sand Dunes These sites are somewhat poorly drained or poorly drained and located downslope from Sand Dune sites.

Similar sites

R115XA103IL	Sand Dunes These sites are on sandy soils and are well drained.
R115XA104IL	Sandy Terrace These sites are located on terraces and are well drained.

Table 1. Dominant plant species

Tree	(1) <i>Quercus stellata</i> (2) <i>Quercus falcata</i>
Shrub	Not specified
Herbaceous	(1) <i>Schizachyrium scoparium</i> (2) <i>Penstemon tubaeflorus</i>

Physiographic features

Sites are on very deep, somewhat excessively drained to excessively drained soils formed in eolian sand on terraces and uplands. Sites occur on dunes along the major rivers containing sandy outwash. Sites may also be found on convex summits of interfluves, terraces, side slopes, and crests of escarpments. Slopes ranges from 2 to 12 percent.

Table 2. Representative physiographic features

Landforms	(1) Dune
Runoff class	Negligible to very low
Flooding frequency	None
Ponding frequency	None
Elevation	340–700 ft
Slope	2–12%

Ponding depth	0 in
Water table depth	72 in
Aspect	W, NW, N, NE, E, SE, S, SW

Climatic features

About 60 percent of the precipitation falls during the freeze-free period. Most of the rainfall occurs as high-intensity, convective thunderstorms in summer. Snowfall is common in winter. The following information is based on data taken from weather stations within MLRA 115X as provided in EDIT.

Table 3. Representative climatic features

Frost-free period (characteristic range)	171-179 days
Freeze-free period (characteristic range)	192-199 days
Precipitation total (characteristic range)	44-47 in
Frost-free period (actual range)	166-180 days
Freeze-free period (actual range)	190-204 days
Precipitation total (actual range)	40-48 in
Frost-free period (average)	175 days
Freeze-free period (average)	196 days
Precipitation total (average)	45 in

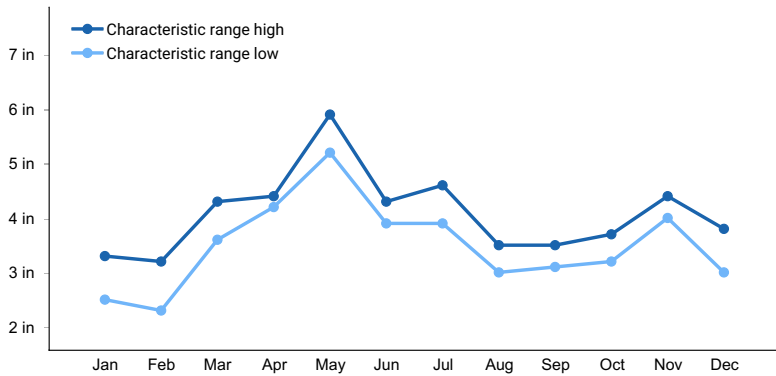

Figure 1. Monthly precipitation range

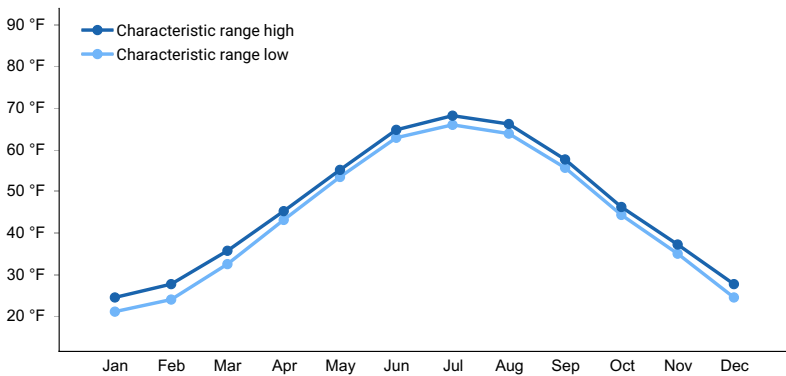

Figure 2. Monthly minimum temperature range

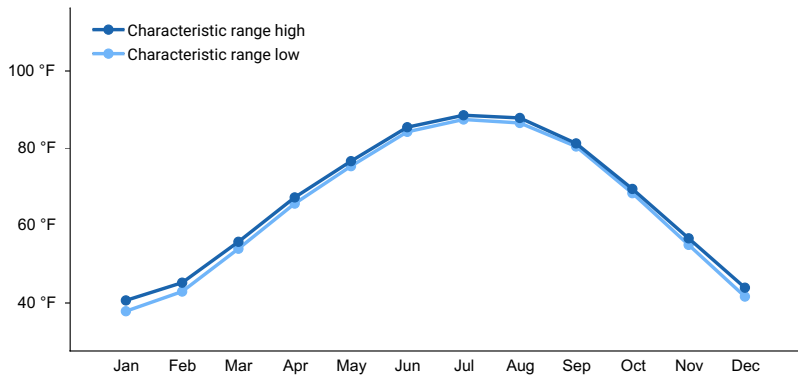

Figure 3. Monthly maximum temperature range

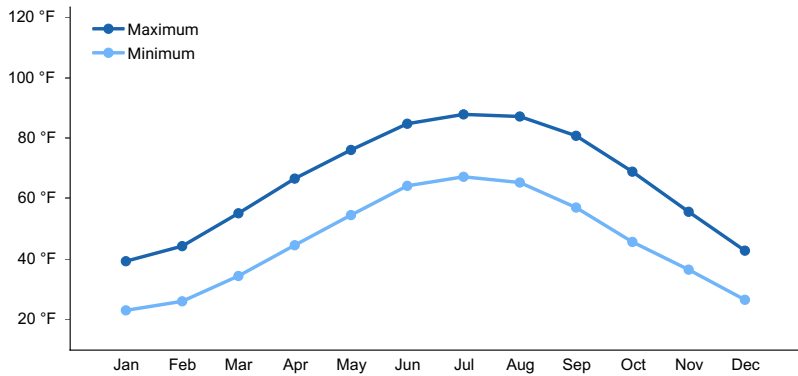

Figure 4. Monthly average minimum and maximum temperature

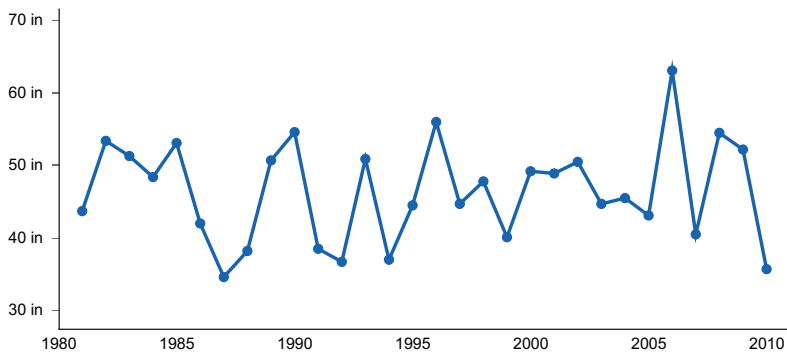

Figure 5. Annual precipitation pattern

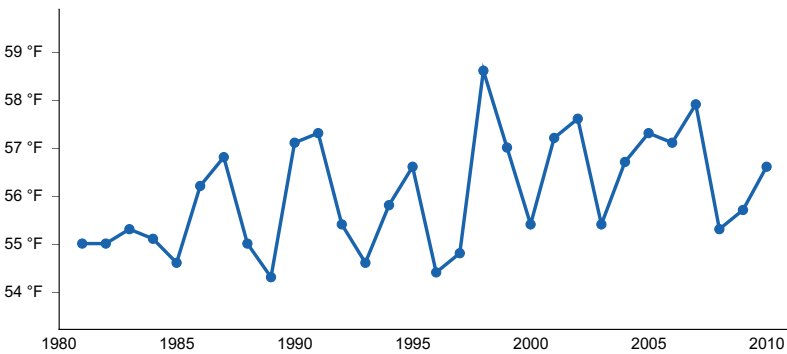

Figure 6. Annual average temperature pattern

Climate stations used

- (1) TERRE HAUTE CAA AP [USW00093823], Terre Haute, IN
- (2) VINCENNES 5 NE [USC00129113], Vincennes, IN
- (3) PRINCETON 1 W [USC00127125], Princeton, IN

- (4) MT VERNON [USC00126001], Uniontown, IN
- (5) EVANSVILLE REGIONAL AP [USW00093817], Evansville, IN

Influencing water features

Sand Dune sites are generally not influenced by flooding or ponding. Some sites may flood rarely. Precipitation is the main source of water for this ecological site. The potential for surface runoff is negligible to medium and varies on slope percentage. Precipitation can infiltrate the soil surface and move freely downward through the soil horizons as there is no restrictive layer in the soil profile. Surface runoff contributes to water on ecological sites downslope. The wet layer depth on these sites is greater than 6 feet.

Soil features

Dry Sand Dune ecological sites are on very deep, somewhat excessively to excessively drained soils that were formed in deposits of eolian sands. These soils are not affected by a seasonal wet layer in the soil profile. Taxonomic groups include Argiudolls, and Udipsammments. Soil series in this group include Ade, and Chelsea.

Table 4. Representative soil features

Parent material	(1) Eolian sands
Surface texture	(1) Loamy fine sand
Family particle size	(1) Coarse-loamy (2) Sandy
Drainage class	Somewhat excessively drained to excessively drained
Permeability class	Rapid
Soil depth	60–80 in
Surface fragment cover <=3"	0%
Surface fragment cover >3"	0%
Available water capacity (Depth not specified)	3.1–4.4 in
Electrical conductivity (Depth not specified)	0 mmhos/cm
Sodium adsorption ratio (Depth not specified)	0
Soil reaction (1:1 water) (Depth not specified)	5.1–7.3
Subsurface fragment volume <=3" (Depth not specified)	0%
Subsurface fragment volume >3" (Depth not specified)	0%

Ecological dynamics

The Dry Sand Dune ecological site occurs on eolian sand dunes on terraces and uplands. The reference community was a dry oak-hickory woodland with frequent fire regimes that maintained an open canopy density and allowed for an understory with a variety of prairie grasses and native forbs. Slopes range from 2-12% so slope and aspect will influence vegetation on these sites.

According to LANDFIRE, fire was historically a key factor in the maintenance of these ecological sites. Impacts to the site were dependent upon fire intensive and frequency. Most natural fires were likely of low to moderate severity and this disturbance regime reduced fire-intolerant species, reduced shrub density, and enhanced the inclusion of prairie herbaceous and grass species on site. Other disturbances would have included fires set by native Americans and early settlers, grazing by livestock, grazing by native ungulates, ice storms, and logging or clearing of sites.

These sandy sites would also be very susceptible during periods of drought. During dry years, plant species adapted to drought conditions would increase on site. Conversely, during multiple years of high precipitation, more mesic species would be found.

Today, many Dry Sand Dune sites are utilized for row-crop agriculture or pasture. Remaining wooded sites have been altered due to lack of a natural fire regime and repeated human disturbances. Long-term fire suppression and anthropogenic site disturbances have resulted in most remaining wooded sites transitioning to a mixed deciduous forest. NRCS has recorded the following trees on site: common hackberry, white ash, blackgum, black walnut, shagbark hickory, and multiple species of oaks.

Landowners should be aware of potential overgrazing impacts such as soil erosion, soil compaction, water quality impacts, and noxious weeds. Invasive non-native vegetation is a serious concern in many remaining disturbed wooded areas as bush honeysuckle, euonymus, Japanese honeysuckle, privet, and other non-native plants have been introduced and are increasing without management controls.

A provisional state and transition diagram is depicted in Figure 2. This model is based on available information and no field verification has been conducted for this initial PES project. It is expected that this project, including the STM, will be enhanced and modified during ecological site description (ESD) development.

State and transition model

Ecosystem states

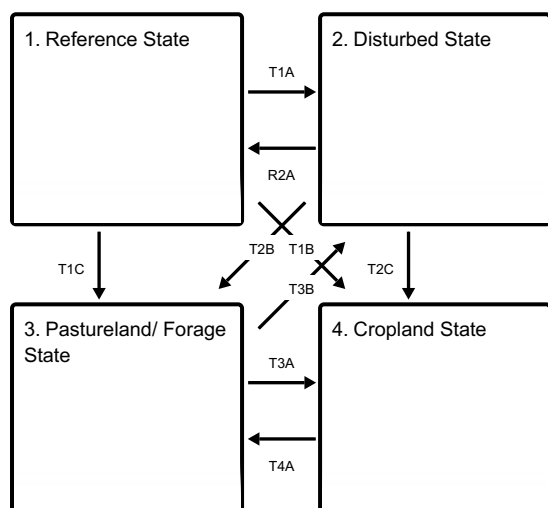

T1A - Large scale disturbance

T1C - Clearing of site; agricultural production - forage

T1B - Clearing of site; agricultural production - row crops.

R2A - Restoration inputs such as planting, brush control, prescribed fire, and timber stand improvement.

T2B - Clearing; agricultural production - forage

T2C - Clearing; agricultural production - row crops

T3B - Abandonment of agricultural practices

T3A - Site preparation and tillage, seeding, weed control, cropland management

T4A - Transition site to forage production; seeding; weed/brush control; pasture management

State 1 submodel, plant communities

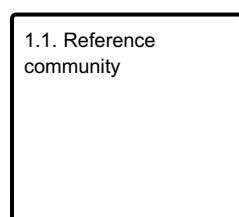

State 2 submodel, plant communities

2.1. Disturbed
community

State 3 submodel, plant communities

3.1.
Pastureland/Forage
community

State 4 submodel, plant communities

4.1. Cropland
community

State 1 Reference State

The vegetative community on this dune woodland community was historically influenced by frequent fire, periods of drought, ungulate grazing, and ice/windstorms. The reference state is an open oak woodland dominated by drought tolerant oak and hickory species and a variety of prairie grasses and native forbs. Slopes range from 0-50% so slope and aspect will influence vegetation on these sites. A reduction in fire frequency will transition this site to a denser woodland with more dry forest species being present.

Dominant plant species

- post oak (*Quercus stellata*), tree
- southern red oak (*Quercus falcata*), tree
- shagbark hickory (*Carya ovata*), tree
- scarlet oak (*Quercus coccinea*), tree
- little bluestem (*Schizachyrium scoparium*), grass
- white wand beardtongue (*Penstemon tubaefflorus*), other herbaceous

Community 1.1 Reference community

The Reference community is a dry oak-hickory upland woodland. Historically, a natural fire regime maintained an open woodland setting with an understory of native grasses and forbs.

Dominant plant species

- post oak (*Quercus stellata*), tree
- scarlet oak (*Quercus coccinea*), tree
- shagbark hickory (*Carya ovata*), tree
- little bluestem (*Schizachyrium scoparium*), grass
- white wand beardtongue (*Penstemon tubaefflorus*), other herbaceous

State 2 Disturbed State

Today, remaining wooded sites have often had repeated and severe disturbances including lack of natural fire regimes, selective oak harvest, clearing, unmanaged grazing, and the introduction of non-native species. Depending on the intensity and duration of the disturbances, multiple tree species may now be on these sites. Lack of natural fire will transition an oak dominated woodland to a more closed canopy woodland with a variety of tree species possible. Tree recorded on sites include hackberry, black oak, white oak, scarlet oak, blackgum, white ash, shagbark hickory, and shingle oak. Tree age, shrub density, and understory composition will vary depending on the type of disturbance, slope, aspect, and fire regime.

Dominant plant species

- oak (*Quercus*), tree
- hybrid hickory (*Carya*), tree
- ash (*Fraxinus*), tree
- red maple (*Acer rubrum*), tree

Community 2.1

Disturbed community

This is a disturbed, successional community that includes a variety of species depending on seed source and disturbance type. Shrub and understory species will depend on the type, severity and length of disturbances, available seed sources, and management inputs, if present.

Dominant plant species

- oak (*Quercus*), tree
- hybrid hickory (*Carya*), tree
- ash (*Fraxinus*), tree
- red maple (*Acer rubrum*), tree

State 3

Pastureland/ Forage State

A portion of these sites have been converted to pastureland or forage production. Species selection will depend upon the objectives and goals of the landowner; however, commonly planted grasses include tall fescue (*Schedonorus arundinaceus*), brome (*Bromus* spp.), white clover (*Trifolium repens*) and red clover (*Trifolium pratense*). Species health and productivity are determined by the management.

Dominant plant species

- tall fescue (*Schedonorus arundinaceus*), grass
- brome (*Bromus*), grass
- Kentucky bluegrass (*Poa pratensis*), grass
- white clover (*Trifolium repens*), other herbaceous
- red clover (*Trifolium pratense*), other herbaceous

Community 3.1

Pastureland/Forage community

These sites are managed for forage production and often include tall fescue (*Schedonorus arundinaceus*), brome (*Bromus* spp.), white clover (*Trifolium repens*) and red clover (*Trifolium pratense*). Selection of species will depend on the landowner's objectives.

Dominant plant species

- tall fescue (*Schedonorus arundinaceus*), grass
- brome (*Bromus*), grass
- Kentucky bluegrass (*Poa pratensis*), grass
- red clover (*Trifolium pratense*), other herbaceous
- white clover (*Trifolium repens*), other herbaceous

State 4

Cropland State

This land use is appropriate only on lower slope sites within this PES group. Common crops include corn (*Zea mays*), soybeans (*Glycine max*), and occasionally winter wheat (*Triticum aestivum*). Some landowners choose to convert sites to cool season grasses for a period before resuming cropland production. A return to the historical Reference State from State 4 is unlikely, if not impossible.

Dominant plant species

- corn (*Zea mays*), other herbaceous
- soybean (*Glycine*), other herbaceous

Community 4.1

Cropland community

This community is characterized by the management and production of row crop agriculture. Common species include corn, soybean and wheat. Many other crops are suitable for these sites, and species selection will depend upon the landowners goals and objectives.

Dominant plant species

- soybean (*Glycine max*), other herbaceous
- corn (*Zea mays*), other herbaceous

Transition T1A

State 1 to 2

Severe disturbances, such as clearing or selective harvesting (oak/hickory removal) , will transition this site to State 2. Long term absence of fire will increase shrub density and alter tree species composition.

Transition T1C

State 1 to 3

Site is transitioned to an agricultural site focused on forage production. Management inputs would include clearing, site preparation, seeding and weed/brush control.

Transition T1B

State 1 to 4

This transition is appropriate for lower slope sites only. Site is transitioned to an agricultural site focused on row crop production. Management inputs would include clearing, site preparation, seeding and weed control.

Restoration pathway R2A

State 2 to 1

Restoration would require long-term management inputs including planting of desired species, weed control, brush control, timber stand improvement, and prescribed fire.

Transition T2B

State 2 to 3

Site is cleared and forage/pasture production is initiated. Management inputs would include tree/shrub removal, site preparation, seeding, and weed/brush control.

Transition T2C

State 2 to 4

Site is cleared and row crop production is initiated. Management inputs would include tree/shrub removal, site preparation, tillage, seeding, and weed control.

Transition T3B

State 3 to 2

Site is abandoned and slowly would transition to a wooded state dominated by deciduous trees. Species on site would depend on the severity and length of disturbance and available seed sources.

Transition T3A

State 3 to 4

Management inputs that transition a site from pasture or forage production to a site that is utilized for row crop production.

Transition T4A

State 4 to 3

Management inputs to transition a site from cropland production to a state of pasture/forage production.

Additional community tables

Inventory data references

A Provisional Ecological Site Description (PESD) describes ecological potential and ecosystem dynamics of land areas and their potential management. Ecological sites are linked to soil survey map unit components, which allows for mapping of ecological sites. A PESD with a provisional status represents the lowest tier of documentation that is releasable to the public. No field level data have been collected as part of this PESD. It is expected that a PESD will continue to be refined through field verification and field sampling.

Reference and alternative state concepts, including the state-and-transition model and vegetative communities are not yet well-documented and will require field sampling for verification.

Other references

Brinson, M. M. 1993. A hydrogeomorphic classification for wetlands. Technical Report WRP-DE-4, U.S. Army Corps of Engineers, Engineer Waterways Experiment Station, Vicksburg, MS.

Braun, E. Lucy. 2001. Deciduous forests of eastern North America. Caldwell, N.J.: Blackburn Press.

Cleland, D. T., J. A. Freeouf, J. E. Keys, G. J. Nowacki, C. Carpenter, and W. H. McNab. 2007. Ecological Subregions: Sections and Subsections of the Conterminous United States. USDA Forest Service, General Technical Report WO-76. Washington, DC. 92 pp.

Comer P. J., Faber-Langendoen D, Evans R, Gawler S. C, Josse C, Kittel G, Menard S, Pyne M, Reid M, Schulz K, Snow K, and Teague J. 2003. Ecological Systems of the United States: A Working Classification of U.S. Terrestrial Systems. NatureServe, Arlington, Virginia.

Cowardin, L.M., V. Carter, F. C. Golet, and E.T. LaRoe. 1979. Classification of wetlands and deep water habitats of the United States. U.S. Dept. of Interior, Fish & Wildlife Service, Office of Biological Services, Washington DC. FWS/OBS-79/31. 142 pp.

Homoya, M. A., Abrell, D. B., Aldrich, J. R., & Post, T. W. (1985). The Natural Regions of Indiana. Indiana Academy of Science, 94, 245-269

Jackson, Marion T. 1997. The Natural heritage of Indiana. Bloomington: Indiana University Press, published in association with the Indiana Department of Natural Resources and the Indiana Academy of Science.

Landfire (Landfire National Vegetation Dynamics Database). 2009. Landfire National Vegetation Dynamics Models. Landfire Project, USDA Forest Service, U.S. Department of Interior. (<http://www.LANDFIRE.gov/index.php>: accessed 2020).

Mohlenbrock, R. H. and D. M. Ladd. 1978. Distribution of Illinois Vascular Plants. Southern Illinois Univ. Press, Carbondale and Edwardsville, Ill. 282 pp.

Mohlenbrock, R. H. 2003. Vascular Flora of Illinois, 3rd edition. Carbondale, Illinois: Southern Illinois University Press. 736 pp.

National Cooperative Soil Survey (NCSS). National Cooperative Soil Characterization Database. Available online: <https://ncsslslabdatamart.sc.egov.usda.gov/>. Accessed: 2020.

NatureServe. 2018. NatureServe Explorer: An online encyclopedia of life [web application]. Version 7.1. NatureServe, Arlington, Virginia. Available <http://explorer.natureserve.org>. (Association Detail Report: C EGL002427) (Accessed: 2020)

Soil Survey Staff, Natural Resources Conservation Service, United States Department of Agriculture. Web Soil Survey (SSS NRCS WSS). Available online at the following link: <https://websoilsurvey.sc.egov.usda.gov/>. Accessed 2020.

Soil Survey Staff, Natural Resources Conservation Service, United States Department of Agriculture. Official Soil Series Descriptions (SSS NRCS OSD). Available online. Accessed 2020.
<https://soilseries.sc.egov.usda.gov/osdname.aspx>

United States Department of Agriculture, Natural Resources Conservation Service (USDA – NRCS). 2006. Land resource regions and major land resource areas of the United States, the Caribbean, and the Pacific Basin. USDA Handbook 296. 682 pp.

United States Department of Agriculture, Natural Resources Conservation Service. 2022. Land resource regions and major land resource areas of the United States, the Caribbean, and the Pacific Basin. U.S. Department of Agriculture, Agriculture Handbook 296.

USDA, NRCS. 2018. The PLANTS Database (<http://plants.usda.gov>, 1 March 2018). National Plant Data Team, Greensboro, NC 27401-4901 USA.

Voigt, J. W., and R. H. Mohlenbrock. 1964. Plant communities of southern Illinois. Southern Illinois University Press, Carbondale. 202 pp.

Whitaker, John O., Charles J. Amlaner, Marion T. Jackson, George R. Parker, and Peter Evans Scott. 2012. Habitats and ecological communities of Indiana presettlement to present. Bloomington: Indiana University Press.

Contributors

Anita Arends, Ecological Site Specialist, USDA-NRCS, Illinois
Ralph Tucker, Soil Survey Office Leader, USDA-NRCS, Missouri
Dena Anderson, Resource Soil Scientist, USDA-NRCS, Indiana
Zack Weber, Soil Scientist, USDA-NRCS, Illinois

Approval

Suzanne Mayne-Kinney, 12/30/2024

Rangeland health reference sheet

Interpreting Indicators of Rangeland Health is a qualitative assessment protocol used to determine ecosystem condition based on benchmark characteristics described in the Reference Sheet. A suite of 17 (or more) indicators are typically considered in an assessment. The ecological site(s) representative of an assessment location must be

known prior to applying the protocol and must be verified based on soils and climate. Current plant community cannot be used to identify the ecological site.

Author(s)/participant(s)	
Contact for lead author	
Date	01/09/2025
Approved by	Suzanne Mayne-Kinney
Approval date	
Composition (Indicators 10 and 12) based on	Annual Production

Indicators

1. **Number and extent of rills:**

2. **Presence of water flow patterns:**

3. **Number and height of erosional pedestals or terracettes:**

4. **Bare ground from Ecological Site Description or other studies (rock, litter, lichen, moss, plant canopy are not bare ground):**

5. **Number of gullies and erosion associated with gullies:**

6. **Extent of wind scoured, blowouts and/or depositional areas:**

7. **Amount of litter movement (describe size and distance expected to travel):**

8. **Soil surface (top few mm) resistance to erosion (stability values are averages - most sites will show a range of values):**

9. **Soil surface structure and SOM content (include type of structure and A-horizon color and thickness):**

10. **Effect of community phase composition (relative proportion of different functional groups) and spatial distribution on infiltration and runoff:**

11. **Presence and thickness of compaction layer (usually none; describe soil profile features which may be**

mistaken for compaction on this site):

12. **Functional/Structural Groups (list in order of descending dominance by above-ground annual-production or live foliar cover using symbols: >>, >, = to indicate much greater than, greater than, and equal to):**

Dominant:

Sub-dominant:

Other:

Additional:

13. **Amount of plant mortality and decadence (include which functional groups are expected to show mortality or decadence):**
-

14. **Average percent litter cover (%) and depth (in):**
-

15. **Expected annual annual-production (this is TOTAL above-ground annual-production, not just forage annual-production):**
-

16. **Potential invasive (including noxious) species (native and non-native). List species which BOTH characterize degraded states and have the potential to become a dominant or co-dominant species on the ecological site if their future establishment and growth is not actively controlled by management interventions. Species that become dominant for only one to several years (e.g., short-term response to drought or wildfire) are not invasive plants. Note that unlike other indicators, we are describing what is NOT expected in the reference state for the ecological site:**
-

17. **Perennial plant reproductive capability:**
-