

Ecological site R115XA104IL Sandy Terrace

Last updated: 12/30/2024
Accessed: 01/09/2025

General information

Provisional. A provisional ecological site description has undergone quality control and quality assurance review. It contains a working state and transition model and enough information to identify the ecological site.

MLRA notes

Major Land Resource Area (MLRA): 115X–Central Mississippi Valley Wooded Slopes

This MLRA is characterized by deeply dissected, loess-covered hills bordering well defined valleys of the Illinois, Mississippi, Missouri, Ohio, and Wabash Rivers and their tributaries. It is used to produce cash crops and livestock. About one-third of the area is forested, mostly on the steeper slopes. This area is in Illinois (50 percent), Missouri (36 percent), Indiana (13 percent), and Iowa (1 percent) in two separate areas. It makes up about 25,084 square miles (64,967 square kilometers).

Most of this area is in the Till Plains section and the Dissected Till Plains section of the Central Lowland province of the Interior Plains. The Springfield-Salem plateaus section of the Ozarks Plateaus province of the Interior Highlands occurs along the Missouri River and the Mississippi River south of the confluence with the Missouri River. The nearly level to very steep uplands are dissected by both large and small tributaries of the Illinois, Mississippi, Missouri, Ohio, and Wabash Rivers. The Ohio River flows along the southernmost boundary of this area in Indiana. Well defined valleys with broad flood plains and numerous stream terraces are along the major streams and rivers. The flood plains along the smaller streams are narrow. Broad summits are nearly level to undulating. Karst topography is common in some parts along the Missouri and Mississippi Rivers and their tributaries. Well-developed karst areas have hundreds of sinkholes, caves, springs, and losing streams. In the St. Louis area, many of the karst features have been obliterated by urban development.

Elevation ranges from 90 feet (20 meters) on the southernmost flood plains to 1,030 feet (320 meters) on the highest ridges. Local relief is mainly 10 to 50 feet (3 to 15 meters) but can be 50 to 150 feet (15 to 45 meters) in the steep, deeply dissected hills bordering rivers and streams. The bluffs along the major rivers are generally 200 to 350 feet (60 to 105 meters) above the valley floor.

The uplands in this MLRA are covered almost entirely with Peoria Loess. The loess can be more than 7 feet (2 meters) thick on stable summits. On the steeper slopes, it is thin or does not occur. In Illinois, the loess is underlain mostly by Illinoian-age till that commonly contains a paleosol. Pre-Illinoian-age till is in parts of this MLRA in Iowa and Missouri and to a minor extent in the western part of Illinois. Wisconsin-age outwash, alluvial deposits, and sandy eolian material are on some of the stream terraces and on dunes along the major tributaries. The loess and glacial deposits are underlain by several bedrock systems. Pennsylvanian and Mississippian bedrock are the most extensive. To a lesser extent are Silurian, Devonian, Cretaceous, and Ordovician bedrock. Karst areas have formed where limestone is near the surface, mostly in the southern part of the MLRA along the Mississippi River and some of its major tributaries. Bedrock outcrops are common on the bluffs along the Mississippi, Ohio, and Wabash Rivers and their major tributaries and at the base of some steep slopes along minor streams and drainageways.

The soils on uplands in this area support natural hardwoods. Oak, hickory, and sugar maple are the dominant species. Big bluestem, little bluestem, and scattered oak and eastern redcedar grow on some sites. The soils on flood plains support mixed forest vegetation, mainly American elm, eastern cottonwood, river birch, green ash, silver maple, sweetgum, American sycamore, pin oak, pecan, and willow. Sedge and grass meadows and scattered trees are on some low-lying sites. (United States Department of Agriculture, Natural Resources Conservation Service,

LRU notes

Most of this LRU (Land Resource Unit) is in the glaciated Till Plains Section of the Central Lowland Province of the Interior Plains. The southeast corner is in the Highland Rim Section (locally known as the Shawnee Hills Section) of the Interior Low Plateaus Province of the Interior Plains. The nearly level to very steep uplands in this LRU are dissected by both large and small tributaries of the Wabash and Ohio Rivers. Well defined valleys with broad flood plains and numerous stream terraces are along the major streams and rivers. The flood plains along the smaller streams are narrow. Broad summits are nearly level to gently sloping.

This area is covered almost entirely with Wisconsin loess, also known as Peoria Loess. The loess can be more than 7 feet (2 meters) thick on stable summits. On the steeper slopes, it is thin or does not occur. The loess throughout the area is underlain dominantly by glacial till. Wisconsin outwash, alluvial deposits, and sandy eolian material are on some of the stream terraces and on dunes along the major tributaries in the area. The loess and glacial drift are underlain by Pennsylvanian-age bedrock. Bedrock outcrops are common in the walls of the valleys along the Wabash and Ohio Rivers and at the base of some steep slopes along minor streams and drainageways.

The dominant soil orders in this LRU are Alfisols, Entisols, Inceptisols, and Mollisols. The soils in the area have a mesic soil temperature regime, a udic or aquic soil moisture regime, and dominantly mixed or smectitic mineralogy. The soils are very deep, poorly drained to excessively drained, and loamy, silty, or clayey. Nearly level Endoaqualfs (Iva series) and Argiaquolls (Ragsdale series) formed in loess on broad upland summits and flats. Nearly level to steep Hapludalfs (Alford, Iona, Muren, Stoy, and Sylvan series) and Fragiudalfs (Hosmer series) formed in loess on uplands. Hapludalfs (Alvin, Bloomfield, and Princeton series) and Argiudolls (Ade series) formed in sandy eolian material in areas of dunes on uplands and stream terraces. Steep and very steep Hapludalfs (Hickory series) formed in Illinoian till along the major streams and dissected upland drainageways. Hapludalfs (Wellston series) formed in siltstone or sandstone residuum on strongly sloping to steep side slopes underlain by bedrock.

The soils in the major stream valleys include Hapludolls (Carmi series), Argiudolls (Elston series), and Hapludalfs (Skelton series), all of which formed in outwash on nearly level to moderately sloping stream terraces and outwash plains. Endoaquolls (Montgomery series), Endoaquepts (Zipp series), Epiaqualfs (McGary series), and Hapludalfs (Shircliff and Markland series) formed in clayey lacustrine sediments on nearly level to strongly sloping lacustrine terraces or lake plains. Endoaquepts (Evansville series), Endoaquolls (Patton series), and Hapludalfs (Henshaw and Uniontown series) formed in silty sediments on terraces and lake plains.

LRU notes (excerpts from Land resource regions and major land resource areas of the United States, the Caribbean, and the Pacific Basin. USDA Handbook 296, 2006)

Classification relationships

Major Land Resource Area (MLRA) 115X–Central Mississippi Valley Wooded Slopes

U.S. Forest Service Ecoregions (Cleland et al. 2007):

Domain: Humid Temperate Domain

Division: Hot Continental Division

Province: Eastern Broadleaf Forest (Continental)

Province Code: 222

Section Code: 222G, 222D

These PES sites are similar to other established ecological classifications. Field verification is needed to confirm any associations.

North Central Dry-Mesic Oak Forest and Woodland

LandFire BpS 4213100

Ecological site concept

The historic pre-European settlement vegetation on this ecological site was dominated by open oak woodlands with a diversity of grasses, sedges, and forbs in the understory. Dominant trees are black oak (*Quercus velutina*), and

white oak (*Quercus alba*). Due to a regular fire regime, these woodlands had an open canopy and a number of prairie species in the understory. Grasses include little bluestem (*Schizachyrium scoparium*), Indiangrass (*Sorghastrum nutans*), and big bluestem (*Andropogon gerardii*). With natural fire regimes occurring, prairie forbs were also present in the understory and included Carolina puccoon (*Lithospermum caroliniense*), lespedezas (*Lespedeza* spp.), flaxleaf whitetop aster (*Ionactis linariifolius*), tall blazing star (*Liatris aspera*), showy goldenrod (*Solidago speciosa*), and birdfoot violet (*Viola pedata*). Fire was the primary historic disturbance factor that maintained this ecological site, while periodic drought and large mammal grazing were secondary factors (LANDFIRE 2009; NatureServe 2020).

Today, most of these sites are in agricultural production or have a history of repeated anthropogenic disturbances such as clearing, grazing, development, invasive species, or selective harvest (oak removal). Lack of natural fire regimes have transitioned these sites to a mixed woodland that includes numerous tree species depending on seed sources and severity of disturbance.

Associated sites

R115XA102IL	Dry Sand Dunes Dry Sand Dune. These sites are on uplands and are somewhat excessively to excessively drained.
F115XA015IL	Loamy Floodplain Loamy Floodplain. These sites are on floodplains and are well drained.

Similar sites

R115XA103IL	Sand Dunes Sand Dune. These sites are on upland sandy soils that are also well drained.
R115XA102IL	Dry Sand Dunes Dry Sand Dune. These sites are on uplands and somewhat excessively to excessively drained.

Table 1. Dominant plant species

Tree	(1) <i>Quercus alba</i> (2) <i>Quercus velutina</i>
Shrub	(1) <i>Corylus americana</i> (2) <i>Salix humilis</i>
Herbaceous	(1) <i>Schizachyrium scoparium</i> (2) <i>Lespedeza capitata</i>

Physiographic features

These sites are located on various landforms including uplands, outwash plains, outwash terraces, and stream terraces. Elevation of these sites are generally between 325' to 1499' and slopes vary from 0-35%. Runoff class is negligible to medium. Flooding is none to rare and sites do not pond.

Table 2. Representative physiographic features

Landforms	(1) Plains > Outwash plain (2) Valley > Terrace (3) Valley > Stream terrace (4) Valley > Outwash terrace
Runoff class	Very low to high
Flooding frequency	None to rare
Ponding frequency	None
Elevation	325–1,499 ft
Slope	0–35%
Water table depth	72 in

Climatic features

About 60 percent of the precipitation falls during the freeze-free period. Most of the rainfall occurs as high-intensity, convective thunderstorms in summer. Snowfall is common in winter. The representative freeze-free period ranges from 192-199 days and the representative frost-free period ranges from 171-179.

The following information is based on data taken from weather stations as provided in EDIT.

Table 3. Representative climatic features

Frost-free period (characteristic range)	171-179 days
Freeze-free period (characteristic range)	192-199 days
Precipitation total (characteristic range)	44-47 in
Frost-free period (actual range)	166-180 days
Freeze-free period (actual range)	190-204 days
Precipitation total (actual range)	40-48 in
Frost-free period (average)	175 days
Freeze-free period (average)	196 days
Precipitation total (average)	45 in

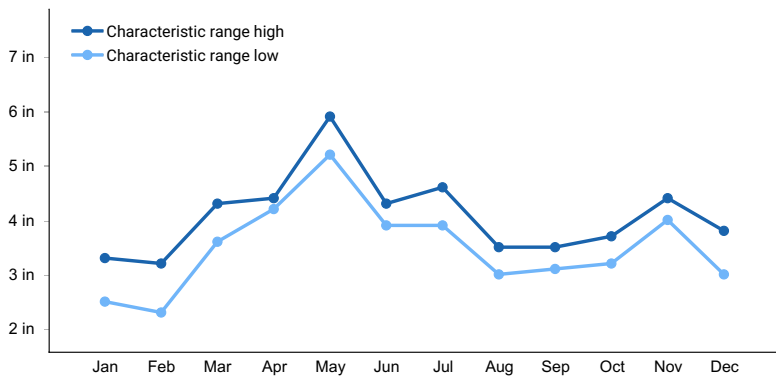

Figure 1. Monthly precipitation range

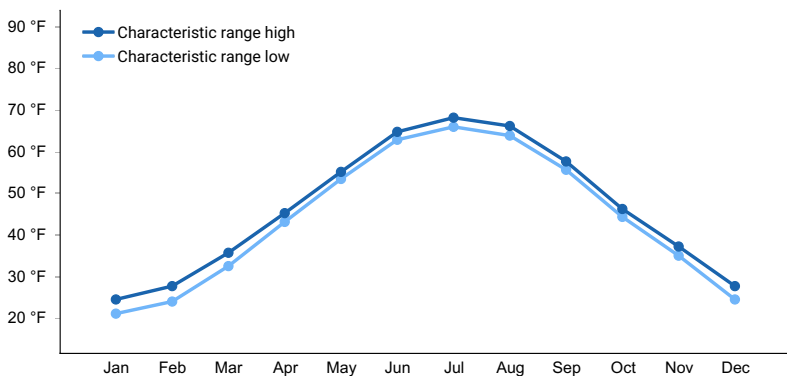

Figure 2. Monthly minimum temperature range

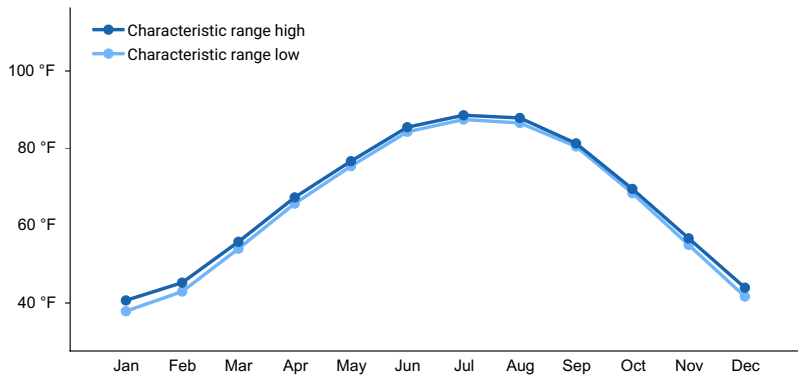

Figure 3. Monthly maximum temperature range

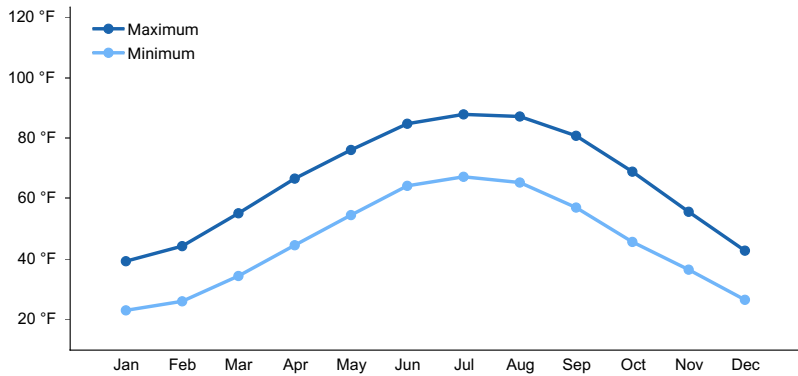

Figure 4. Monthly average minimum and maximum temperature

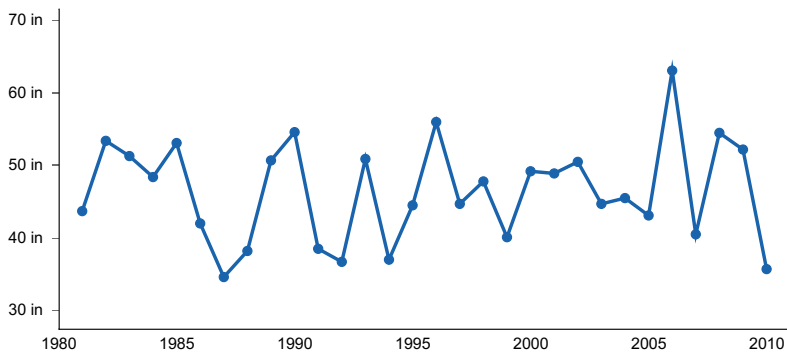

Figure 5. Annual precipitation pattern

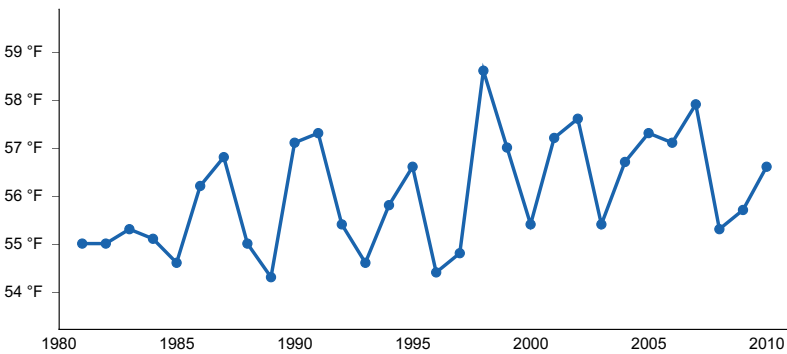

Figure 6. Annual average temperature pattern

Climate stations used

- (1) TERRE HAUTE CAA AP [USW00093823], Terre Haute, IN
- (2) VINCENNES 5 NE [USC00129113], Vincennes, IN
- (3) PRINCETON 1 W [USC00127125], Princeton, IN

- (4) EVANSVILLE REGIONAL AP [USW00093817], Evansville, IN
- (5) MT VERNON [USC00126001], Uniontown, IN

Influencing water features

Flooding on Sandy Terrace sites ranges from none to rarely. Precipitation is the main source of water for vegetation. On sloping sites, surface runoff water occurs to downslope ecological sites.

Soil features

These sites are very deep, well-drained, with moderately slow to moderate permeability. They are formed in eolian deposits, eolian sand, gravelly outwash, coarse-loamy outwash, coarse-loamy deposits over gravelly outwash, or sandy outwash. Available water capacity (AWC) on sites varies in this grouping (2- 7 inches), but the majority of Sandy Terrace sites have an AWC between 4-6 inches. Soil textures include coarse loamy, fine loamy and loamy skeletal. Series include Alvin, Conotton, Carmi, Elston, Lamont, Onarga, and Stockland.

Table 4. Representative soil features

Parent material	(1) Eolian deposits (2) Eolian sands (3) Outwash
Surface texture	(1) Sandy loam (2) Fine sandy loam (3) Coarse sandy loam (4) Loam (5) Very fine sandy loam (6) Loamy sand (7) Loamy fine sand
Drainage class	Well drained
Permeability class	Moderately slow to moderate
Depth to restrictive layer	60–80 in
Soil depth	60–80 in
Surface fragment cover <=3"	0%
Surface fragment cover >3"	0%
Available water capacity (Depth not specified)	4–6 in
Calcium carbonate equivalent (Depth not specified)	0–30%
Electrical conductivity (Depth not specified)	0 mmhos/cm
Sodium adsorption ratio (Depth not specified)	0
Subsurface fragment volume <=3" (Depth not specified)	0%
Subsurface fragment volume >3" (Depth not specified)	0%

Ecological dynamics

MLRA 115X consists of a variety of environmental and edaphic factors that have resulted in a historic landscape that supported upland hardwood forests, mixed floodplain/terrace forests, and scattered open woodlands and prairie savannas. Sandy Terrace ecological sites were formed within this vegetative continuum and community structure was controlled by a natural fire regime, grazing of large mammals and later, burning by native Americans and settlers. Sandy Terrace sites generally occur on high stream terraces on well-drained, sandy loam soils. Species characteristic of this ecological site consist of an open canopy of oaks with a diverse understory which includes

prairie grasses and forbs.

Fire is the critical factor that maintained Sandy Terrace sites. Fire typically consisted of low- to moderate-severity surface fires every 10-25 years (LANDFIRE 2009). Ignition sources included summertime lightning strikes from convective storms and bimodal, human ignitions during the spring and fall seasons. Native Americans regularly set fires to improve hunting, move large mammals, increase native grasses, clearing for wood, and agriculture. (LANDFIRE 2009).

Drought and wind/ice storms also would have impacted these sites and the plant community structure and density. Droughts would have increased tree, shrub and understory species that could tolerate very dry conditions. Ice and wind damage to trees from storms would have opened canopies and temporarily altering shrub and understory community structure.

Today, Sandy Terrace sites have mostly been converted to cropland (lower slopes), or pastureland. Landowners should be aware of potential overgrazing impacts such as soil erosion, soil compaction, water quality impacts, and noxious weeds. Invasive non-native vegetation is a serious concern in many remaining wooded areas as bush honeysuckle, euonymus, Japanese honeysuckle, privet, and other non-native plants have been introduced and are increasing without management controls.

Remnant woodlands do exist, but tree species and understory density and diversity have been fundamentally altered due to long-term fire suppressed and repeated anthropogenic disturbances. NRCS has recorded numerous trees on these sites including white oak, ash, black walnut, northern red oak, and tuliptree.

A provisional state and transition diagram (STM) is shown in Figure 2. The model is a provisional draft and it is expected to change as field verification occurs.

State and transition model

Ecosystem states

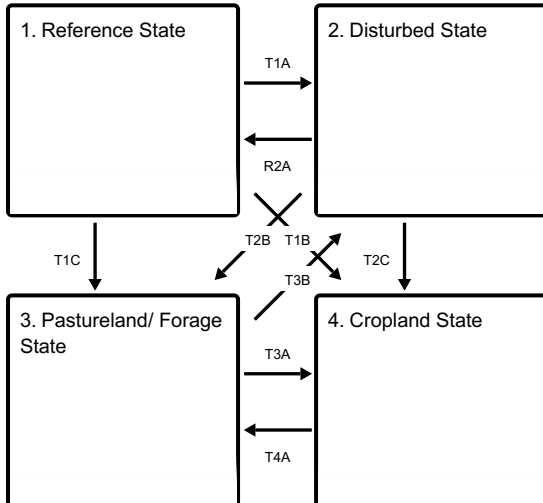

T1A - Large scale disturbance

T1C - Clearing of site; agricultural production - forage

T1B - Clearing of site; agricultural production - row crops.

R2A - Restoration inputs such as planting, brush control, prescribed fire, and timber stand improvement.

T2B - Clearing; agricultural production - forage

T2C - Clearing; agricultural production - row crops

T3B - Abandonment of agricultural practices

T3A - Site preparation and tillage, seeding, weed control, cropland management

T4A - Transition site to forage production; seeding; weed/brush control; pasture management

State 1 submodel, plant communities

1.1. Reference community

State 2 submodel, plant communities

2.1. Disturbed community

State 3 submodel, plant communities

3.1. Pastureland/Forage community

State 4 submodel, plant communities

4.1. Cropland community

State 1 Reference State

The historic reference state for Sandy Terrace ecological site is dependent on recurring fire intervals. The severity and intensity of the fire will alter species composition and density. Frequent fires will reduce shrub density and promote oak reproduction. A reduction in the fire frequency will allow an increase in wood vegetation and an increase in fire-intolerant tree species. An increase in tree and shrub density will increase canopy cover shading and will influence the understory community composition. Historically, natural fires maintained either an open savanna or open woodland community that included numerous prairie grasses and forbs. Few, if any, of these historic ecosystems exist today on the soils within this PES group. Most sites in MLRA 115A are utilized for agricultural production or have been repeatedly disturbed through fire suppression, grazing, logging, clearing, or development. Today, numerous tree species may be present and wooded sites generally have many co-dominant tree species. NRCS has documented many trees on these sites including white oak, red oak, hickory, black walnut, ash, maple and tulip poplar.

Dominant plant species

- white oak (*Quercus alba*), tree
- black oak (*Quercus velutina*), tree
- American hazelnut (*Corylus americana*), shrub
- prairie willow (*Salix humilis*), shrub
- little bluestem (*Schizachyrium scoparium*), grass
- switchgrass (*Panicum virgatum*), grass
- lespedeza (*Lespedeza*), other herbaceous

Community 1.1

Reference community

This community is a oak woodland with numerous native grasses, sedges and herbaceous species in the understory. A natural fire regime reduces shrub density and allows for oak regeneration while reducing fire intolerant species such as maple.

Dominant plant species

- black oak (*Quercus velutina*), tree
- white oak (*Quercus alba*), tree
- American hazelnut (*Corylus americana*), shrub
- prairie willow (*Salix humilis*), shrub
- little bluestem (*Schizachyrium scoparium*), grass
- switchgrass (*Panicum virgatum*), grass
- lespedeza (*Lespedeza*), other herbaceous

State 2

Disturbed State

Most remaining wooded Sandy Terrace sites have been altered due to anthropogenic disturbances. Sites have been cleared, grazed, or had intermittent selective harvest (i.e. oak removal). Trees on site, will depending on the type, length and severity of disturbances. Sites that have had a long-term absence of fire will display the following characteristics: an increase in fire -intolerant species, decrease in oak regeneration, an increase in shrub density, an increase in leaf-litter buildup, and an increase in shade-tolerant understory species. Diversity of species may also be reduced, especially if there has been an introduction of non-native species such as bush honeysuckle (*Lonicera maackii*). Many of these sites are eventually transitioned to Pastureland (State 3) or cropland (State 4) on lower slope sites.

Dominant plant species

- eastern redcedar (*Juniperus virginiana*), tree
- sugar maple (*Acer saccharum*), tree
- red maple (*Acer rubrum*), tree
- white ash (*Fraxinus americana*), tree
- oak (*Quercus*), tree
- hybrid hickory (*Carya*), tree
- American hazelnut (*Corylus americana*), shrub
- blackberry (*Rubus*), shrub
- sumac (*Rhus*), shrub
- rose (*Rosa*), shrub

Community 2.1

Disturbed community

This site has undergone disturbances such as clearing, selective logging, unmanaged grazing, etc. Oak removal is a common disturbance on these sites. Lack of natural fire will increase the density and numbers of cedar, maple, and ash.

Dominant plant species

- sugar maple (*Acer saccharum*), tree
- eastern redcedar (*Juniperus virginiana*), tree
- red maple (*Acer rubrum*), tree
- white ash (*Fraxinus americana*), tree
- hybrid hickory (*Carya*), tree
- oak (*Quercus*), tree
- American hazelnut (*Corylus americana*), shrub
- sumac (*Rhus*), shrub

- rose (*Rosa*), shrub
- blackberry (*Rubus*), shrub

State 3

Pastureland/ Forage State

A portion of these sites have been converted to pastureland or forage production. Species selection will depend upon the objectives and goals of the landowner; however, commonly planted grasses include tall fescue (*Schedonorus arundinaceus*), brome (*Bromus* spp.), white clover (*Trifolium repens*) and red clover (*Trifolium pratense*). Species health and productivity are determined by the management and long-term overgrazing on some sites has caused soil erosion and compaction.

Dominant plant species

- tall fescue (*Schedonorus arundinaceus*), grass
- brome (*Bromus*), grass
- Kentucky bluegrass (*Poa pratensis*), grass
- white clover (*Trifolium repens*), other herbaceous
- red clover (*Trifolium pratense*), other herbaceous

Community 3.1

Pastureland/Forage community

These sites are managed for forage production and often include tall fescue (*Schedonorus arundinaceus*), brome (*Bromus* spp.), white clover (*Trifolium repens*) and red clover (*Trifolium pratense*). Selection of species will depend on the landowner's objectives.

Dominant plant species

- tall fescue (*Schedonorus arundinaceus*), grass
- brome (*Bromus*), grass
- Kentucky bluegrass (*Poa pratensis*), grass
- red clover (*Trifolium pratense*), other herbaceous
- white clover (*Trifolium repens*), other herbaceous

State 4

Cropland State

Common crops include corn (*Zea mays*), soybeans (*Glycine max*), and occasionally winter wheat (*Triticum aestivum*). Some landowners choose to convert sites to cool season grasses for a period before resuming cropland production. A return to the historical Reference State from State 4 is unlikely, if not impossible.

Dominant plant species

- corn (*Zea mays*), other herbaceous
- soybean (*Glycine*), other herbaceous

Community 4.1

Cropland community

This community is characterized by the management and production of row crop agriculture. Common species include corn, soybean and wheat. Many other crops are suitable for these sites, and species selection will depend upon the landowners goals and objectives.

Dominant plant species

- soybean (*Glycine max*), other herbaceous
- corn (*Zea mays*), other herbaceous

Transition T1A

State 1 to 2

Severe disturbances, such as clearing or selective harvesting (oak/hickory removal) will transition this site to State 2. Long-term lack of fire will also transition this state to a more mixed deciduous forest community.

Transition T1C

State 1 to 3

Site is transitioned to an agricultural site focused on forage production. Management inputs would include clearing, site preparation, seeding and weed/brush control.

Transition T1B

State 1 to 4

Site is transitioned to an agricultural site focused on row crop production. Management inputs would include clearing, site preparation, seeding and weed control.

Restoration pathway R2A

State 2 to 1

Restoration would require long-term management inputs including planting of desired species, weed control, brush control, timber stand improvement, and prescribed fire.

Transition T2B

State 2 to 3

Site is cleared and forage/pasture production is initiated. Management inputs would include tree/shrub removal, site preparation, seeding, and weed/brush control.

Transition T2C

State 2 to 4

Site is cleared and row crop production is initiated. Management inputs would include tree/shrub removal, site preparation, tillage, seeding, and weed control.

Transition T3B

State 3 to 2

Site is abandoned and slowly would transition to a wooded state dominated by deciduous trees. Species on site would depend on the severity and length of disturbance and available seed sources.

Transition T3A

State 3 to 4

Management inputs that transition a site from pasture or forage production to a site that is utilized for row crop production.

Transition T4A

State 4 to 3

Management inputs to transition a site from cropland production to a state of pasture/forage production.

Additional community tables

Inventory data references

A Provisional Ecological Site Description (PESD) describes ecological potential and ecosystem dynamics of land areas and their potential management. Ecological sites are linked to soil survey map unit components, which allows for mapping of ecological sites. A PESD with a provisional status represents the lowest tier of documentation that is releasable to the public. No field level data have been collected as part of this PESD. It is expected that a PESD will continue to be refined through field verification and field sampling.

Reference and alternative state concepts, including the state-and-transition model and vegetative communities are not yet well-documented and will require field sampling for verification.

Other references

Brinson, M. M. 1993. A hydrogeomorphic classification for wetlands. Technical Report WRP-DE-4, U.S. Army Corps of Engineers, Engineer Waterways Experiment Station, Vicksburg, MS.

Braun, E. Lucy. 2001. Deciduous forests of eastern North America. Caldwell, N.J.: Blackburn Press.

Cleland, D. T., J. A. Freeouf, J. E. Keys, G. J. Nowacki, C. Carpenter, and W. H. McNab. 2007. Ecological Subregions: Sections and Subsections of the Coterminous United States. USDA Forest Service, General Technical Report WO-76. Washington, DC. 92 pp.

Comer P. J., Faber-Langendoen D, Evans R, Gawler S. C, Josse C, Kittel G, Menard S, Pyne M, Reid M, Schulz K, Snow K, and Teague J. 2003. Ecological Systems of the United States: A Working Classification of U.S. Terrestrial Systems. NatureServe, Arlington, Virginia.

Cowardin, L.M., V. Carter, F. C. Golet, and E.T. LaRoe. 1979. Classification of wetlands and deep water habitats of the United States. U.S. Dept. of Interior, Fish & Wildlife Service, Office of Biological Services, Washington DC. FWS/OBS-79/31. 142 pp.

Homoya, M. A., Abrell, D. B., Aldrich, J. R., & Post, T. W. (1985). The Natural Regions of Indiana. Indiana Academy of Science, 94, 245-269

Jackson, Marion T. 1997. The Natural heritage of Indiana. Bloomington: Indiana University Press, published in association with the Indiana Department of Natural Resources and the Indiana Academy of Science.

LANDFIRE (Landfire National Vegetation Dynamics Database). 2009. Landfire National Vegetation Dynamics Models. Landfire Project, USDA Forest Service, U.S. Department of Interior. (<http://www.LANDFIRE.gov/index.php>: accessed 2020).

Mohlenbrock, R. H. and D. M. Ladd. 1978. Distribution of Illinois Vascular Plants. Southern Illinois Univ. Press, Carbondale and Edwardsville, Ill. 282 pp.

Mohlenbrock, R. H. 2003. Vascular Flora of Illinois, 3rd edition. Carbondale, Illinois: Southern Illinois University Press. 736 pp.

National Cooperative Soil Survey (NCSS). National Cooperative Soil Characterization Database. Available online: <https://ncsslabsdatamart.sc.egov.usda.gov/>. Accessed: 2020.

NatureServe. 2018. NatureServe Explorer: An online encyclopedia of life [web application]. Version 7.1. NatureServe, Arlington, Virginia. Available <http://explorer.natureserve.org>. (Association Detail Report: CEG002427) (Accessed: 2020)

Soil Survey Staff, Natural Resources Conservation Service, United States Department of Agriculture. Web Soil Survey (SSS NRCS WSS). Available online at the following link: <https://websoilsurvey.sc.egov.usda.gov/>. Accessed 2020.

Soil Survey Staff, Natural Resources Conservation Service, United States Department of Agriculture. Official Soil Series Descriptions (SSS NRCS OSD). Available online. Accessed 2020.

<https://soilseries.sc.egov.usda.gov/osdname.aspx>

United States Department of Agriculture, Natural Resources Conservation Service (USDA – NRCS). 2006. Land resource regions and major land resource areas of the United States, the Caribbean, and the Pacific Basin. USDA Handbook 296. 682 pp.

United States Department of Agriculture, Natural Resources Conservation Service. 2022. Land resource regions and major land resource areas of the United States, the Caribbean, and the Pacific Basin. U.S. Department of Agriculture, Agriculture Handbook 296.

USDA, NRCS. 2018. The PLANTS Database (<http://plants.usda.gov>, 1 March 2018). National Plant Data Team, Greensboro, NC 27401-4901 USA.

Voigt, J. W., and R. H. Mohlenbrock. 1964. Plant communities of southern Illinois. Southern Illinois University Press, Carbondale. 202 pp.

Whitaker, John O., Charles J. Amlaner, Marion T. Jackson, George R. Parker, and Peter Evans Scott. 2012. Habitats and ecological communities of Indiana presettlement to present. Bloomington: Indiana University Press.

Contributors

Anita Arends, Ecological Site Specialist, USDA-NRCS, Illinois
Ralph Tucker, Soil Survey Office Leader, USDA-NRCS, Missouri
Dena Anderson, Resource Soil Scientist, USDA-NRCS, Indiana
Zack Weber, Soil Scientist, USDA-NRCS, Illinois

Approval

Suzanne Mayne-Kinney, 12/30/2024

Rangeland health reference sheet

Interpreting Indicators of Rangeland Health is a qualitative assessment protocol used to determine ecosystem condition based on benchmark characteristics described in the Reference Sheet. A suite of 17 (or more) indicators are typically considered in an assessment. The ecological site(s) representative of an assessment location must be known prior to applying the protocol and must be verified based on soils and climate. Current plant community cannot be used to identify the ecological site.

Author(s)/participant(s)	
Contact for lead author	
Date	01/09/2025
Approved by	Suzanne Mayne-Kinney
Approval date	
Composition (Indicators 10 and 12) based on	Annual Production

Indicators

1. Number and extent of rills:

2. Presence of water flow patterns:

3. **Number and height of erosional pedestals or terracettes:**

4. **Bare ground from Ecological Site Description or other studies (rock, litter, lichen, moss, plant canopy are not bare ground):**

5. **Number of gullies and erosion associated with gullies:**

6. **Extent of wind scoured, blowouts and/or depositional areas:**

7. **Amount of litter movement (describe size and distance expected to travel):**

8. **Soil surface (top few mm) resistance to erosion (stability values are averages - most sites will show a range of values):**

9. **Soil surface structure and SOM content (include type of structure and A-horizon color and thickness):**

10. **Effect of community phase composition (relative proportion of different functional groups) and spatial distribution on infiltration and runoff:**

11. **Presence and thickness of compaction layer (usually none; describe soil profile features which may be mistaken for compaction on this site):**

12. **Functional/Structural Groups (list in order of descending dominance by above-ground annual-production or live foliar cover using symbols: >>, >, = to indicate much greater than, greater than, and equal to):**

Dominant:

Sub-dominant:

Other:

Additional:

13. **Amount of plant mortality and decadence (include which functional groups are expected to show mortality or decadence):**

14. **Average percent litter cover (%) and depth (in):**

15. **Expected annual annual-production (this is TOTAL above-ground annual-production, not just forage annual-production):**

16. **Potential invasive (including noxious) species (native and non-native). List species which BOTH characterize degraded states and have the potential to become a dominant or co-dominant species on the ecological site if their future establishment and growth is not actively controlled by management interventions. Species that become dominant for only one to several years (e.g., short-term response to drought or wildfire) are not invasive plants. Note that unlike other indicators, we are describing what is NOT expected in the reference state for the ecological site:**

17. **Perennial plant reproductive capability:**
