

Ecological site F115XA006IL

Clayey Terrace

Last updated: 12/30/2024
Accessed: 04/09/2026

General information

Provisional. A provisional ecological site description has undergone quality control and quality assurance review. It contains a working state and transition model and enough information to identify the ecological site.

MLRA notes

Major Land Resource Area (MLRA): 115X–Central Mississippi Valley Wooded Slopes

This MLRA is characterized by deeply dissected, loess-covered hills bordering well defined valleys of the Illinois, Mississippi, Missouri, Ohio, and Wabash Rivers and their tributaries. It is used to produce cash crops and livestock. About one-third of the area is forested, mostly on the steeper slopes. This area is in Illinois (50 percent), Missouri (36 percent), Indiana (13 percent), and Iowa (1 percent) in two separate areas. It makes up about 25,084 square miles (64,967 square kilometers).

Most of this area is in the Till Plains section and the Dissected Till Plains section of the Central Lowland province of the Interior Plains. The Springfield-Salem plateaus section of the Ozarks Plateaus province of the Interior Highlands occurs along the Missouri River and the Mississippi River south of the confluence with the Missouri River. The nearly level to very steep uplands are dissected by both large and small tributaries of the Illinois, Mississippi, Missouri, Ohio, and Wabash Rivers. The Ohio River flows along the southernmost boundary of this area in Indiana. Well defined valleys with broad flood plains and numerous stream terraces are along the major streams and rivers. The flood plains along the smaller streams are narrow. Broad summits are nearly level to undulating. Karst topography is common in some parts along the Missouri and Mississippi Rivers and their tributaries. Well-developed karst areas have hundreds of sinkholes, caves, springs, and losing streams. In the St. Louis area, many of the karst features have been obliterated by urban development.

Elevation ranges from 90 feet (20 meters) on the southernmost flood plains to 1,030 feet (320 meters) on the highest ridges. Local relief is mainly 10 to 50 feet (3 to 15 meters) but can be 50 to 150 feet (15 to 45 meters) in the steep, deeply dissected hills bordering rivers

and streams. The bluffs along the major rivers are generally 200 to 350 feet (60 to 105 meters) above the valley floor.

The uplands in this MLRA are covered almost entirely with Peoria Loess. The loess can be more than 7 feet (2 meters) thick on stable summits. On the steeper slopes, it is thin or does not occur. In Illinois, the loess is underlain mostly by Illinoian-age till that commonly contains a paleosol. Pre-Illinoian-age till is in parts of this MLRA in Iowa and Missouri and to a minor extent in the western part of Illinois. Wisconsin-age outwash, alluvial deposits, and sandy eolian material are on some of the stream terraces and on dunes along the major tributaries. The loess and glacial deposits are underlain by several bedrock systems. Pennsylvanian and Mississippian bedrock are the most extensive. To a lesser extent are Silurian, Devonian, Cretaceous, and Ordovician bedrock. Karst areas have formed where limestone is near the surface, mostly in the southern part of the MLRA along the Mississippi River and some of its major tributaries. Bedrock outcrops are common on the bluffs along the Mississippi, Ohio, and Wabash Rivers and their major tributaries and at the base of some steep slopes along minor streams and drainageways.

The annual precipitation ranges from 35 to 49 inches (880 to 1,250 millimeters) with a mean of 41 inches (1,050 millimeters). The annual temperature ranges from 48 to 58 degrees F (8.6 to 14.3 degrees C) with a mean of 54 degrees F (12.3 degrees C). The freeze-free period ranges from 150 to 220 days with a mean of 195 days.

Soils The dominant soil orders are Alfisols and, to a lesser extent, Entisols and Mollisols. The soils in the area have a mesic soil temperature regime, an aquic or udic soil moisture regime, and mixed or smectitic mineralogy. They are shallow to very deep, excessively drained to poorly drained, and loamy, silty, or clayey.

The soils on uplands in this area support natural hardwoods. Oak, hickory, and sugar maple are the dominant species. Big bluestem, little bluestem, and scattered oak and eastern redcedar grow on some sites. The soils on flood plains support mixed forest vegetation, mainly American elm, eastern cottonwood, river birch, green ash, silver maple, sweetgum, American sycamore, pin oak, pecan, and willow. Sedge and grass meadows and scattered trees are on some low-lying sites. (United States Department of Agriculture, Natural Resources Conservation Service, 2022)

LRU notes

Most of this LRU (Land Resource Unit) is in the glaciated Till Plains Section of the Central Lowland Province of the Interior Plains. The southeast corner is in the Highland Rim Section (locally known as the Shawnee Hills Section) of the Interior Low Plateaus Province of the Interior Plains. The nearly level to very steep uplands in this LRU are dissected by both large and small tributaries of the Wabash and Ohio Rivers. Well defined valleys with broad flood plains and numerous stream terraces are along the major streams and rivers. The flood plains along the smaller streams are narrow. Broad summits are nearly level to gently sloping.

This area is covered almost entirely with Wisconsin loess. The loess can be more than 7 feet (2 meters) thick on stable summits. On the steeper slopes, it is thin or does not occur. The loess throughout the area is underlain dominantly by glacial till. Wisconsin outwash, alluvial deposits, and sandy eolian material are on some of the stream terraces and on dunes along the major tributaries in the area. The loess and glacial drift are underlain by Pennsylvanian-age bedrock. Bedrock outcrops are common in the walls of the valleys along the Wabash and Ohio Rivers and at the base of some steep slopes along minor streams and drainageways.

The dominant soil orders in this LRU are Alfisols, Entisols, Inceptisols, and Mollisols. The soils in the area have a mesic soil temperature regime, a udic or aquic soil moisture regime, and dominantly mixed or smectitic mineralogy. The soils are very deep, poorly drained to excessively drained, and loamy, silty, or clayey. Nearly level Endoaqualfs (Iva series) and Argiaquolls (Ragsdale series) formed in loess on broad upland summits and flats. Nearly level to steep Hapludalfs (Alford, Iona, Muren, Stoy, and Sylvan series) and Fragiudalfs (Hosmer series) formed in loess on uplands. Hapludalfs (Alvin, Bloomfield, and Princeton series) and Argiudolls (Ade series) formed in sandy eolian material in areas of dunes on uplands and stream terraces. Steep and very steep Hapludalfs (Hickory series) formed in Illinoian till along the major streams and dissected upland drainageways. Hapludalfs (Wellston series) formed in siltstone or sandstone residuum on strongly sloping to steep side slopes underlain by bedrock.

The soils in the major stream valleys include Hapludolls (Carmi series), Argiudolls (Elston series), and Hapludalfs (Skelton series), all of which formed in outwash on nearly level to moderately sloping stream terraces and outwash plains. Endoaquolls (Montgomery series), Endoaquepts (Zipp series), Epiaqualfs (McGary series), and Hapludalfs (Shircliff and Markland series) formed in clayey lacustrine sediments on nearly level to strongly sloping lacustrine terraces or lake plains. Endoaquepts (Evansville series), Endoaquolls (Patton series), and Hapludalfs (Henshaw and Uniontown series) formed in silty sediments on terraces and lake plains.

LRU notes (excerpts from Land resource regions and major land resource areas of the United States, the Caribbean, and the Pacific Basin. USDA Handbook 296, 2006)

Classification relationships

Major Land Resource Area (MLRA) (USDA-NRCS, 2022):
115X–Central Mississippi Valley Wooded Slopes

U.S. Forest Service Ecoregions (Cleland et al. 2007):

Domain: Humid Temperate Domain

Division: Hot Continental Division

Province: Eastern Broadleaf Forest (Continental)

Province Code: 222

Section Code: 222G, 222D

These PES sites are similar to other established ecological classifications. Field verification is needed to confirm this association.

International Vegetation Classification Hierarchy

Class: 1. Forest & Woodland

Subclass: 1.B. Temperate & Boreal Forest & Woodland

Formation: 1.B.3. Temperate Flooded & Swamp Forest

Division: 1.B.3.Na. Eastern North American-Great Plains Flooded & Swamp Forest

Macrogroup: M029. Central Hardwood Floodplain Forest

Group: G652. Midwest Floodplain Forest

Ecological site concept

The historic pre-European settlement vegetation or reference plant community for Clayey Terrace ecological sites was a mature deciduous forest with a dense tree canopy and a substantial oak component. The understory consisted of shade-tolerant shrubs and a diverse shade-tolerant herbaceous layer. These sites occurred on well-drained and moderately well drained terraces with slopes ranging from 2-25%, so sites will exhibit differences in vegetation due to slope, drainage, aspect, and depth to wet layer.

Multiple tree species may be on the site including northern red oak (*Quercus rubra*), Shumard oak (*Quercus shumardii*), bur oak (*Quercus pagoda*), American elm (*Ulmus americana*), sugar maple (*Acer saccharum*) tulip poplar (*Liriodendron tulipifera*), basswood (*Tilia americana*), bitternut hickory (*Carya cordiformis*), mockernut hickory (*Carya tomentosa*), white ash (*Fraxinus americana*), and American elm (*Ulmus americana*). Sites with higher water tables or in topographic depressions may include pin oak (*Q. palustris*), red maple (*Acer rubrum*), and green ash (*Fraxinus pensylvanica*). The native shrub and herbaceous layers will vary greatly on these sites depending on seasonal high-water table depth, flooding regime, microtopography and aspect.

Today, anthropogenic disturbances such as grazing, oak and logging, invasive species, and agriculture have modified most sites. Remaining woodlands have usually incurred repeated disturbance and are often contain a mix of tulip poplar (*Liriodendron tulipifera*), red maple (*Acer rubrum*), ashes (*Fraxinus* spp.), basswood (*Tilia americana*), and sugar maple (*Acer saccharum*).

Associated sites

F115XA007IL	Wet Clayey Terrace Wet Clayey Terrace. These sites are somewhat poorly to poorly drained but also located on terraces.
-------------	--

Table 1. Dominant plant species

Tree	(1) <i>Quercus rubra</i> (2) <i>Carya cordiformis</i>
Shrub	(1) <i>Asimina triloba</i> (2) <i>Cornus</i>
Herbaceous	(1) <i>Vitis</i> (2) <i>Carex</i>

Physiographic features

Clayey Terrace sites are located generally on terraces, lake terraces, glacial lakes (relic), and lake plains. Elevation of these sites are generally between 341 to 699 feet. They are formed in loess and the underlying fine-textured lacustrine sediments. Wet layer depth can range from 18 inches to greater than 6 feet. The runoff class is low to very high, and the permeability is very slow.

Table 2. Representative physiographic features

Landforms	(1) Stream terrace (2) Terrace (3) Lake plain (4) Glacial lake (relict)
Runoff class	Medium to high
Flooding frequency	None
Ponding frequency	None
Elevation	104–213 m
Slope	2–25%
Water table depth	46–183 cm
Aspect	W, NW, N, NE, E, SE, S, SW

Table 3. Representative physiographic features (actual ranges)

Runoff class	Low to very high
Flooding frequency	None to rare
Ponding frequency	None
Elevation	100–310 m
Slope	Not specified
Water table depth	Not specified

Climatic features

About 60 percent of the precipitation falls during the freeze-free period. Most of the rainfall occurs as high-intensity, convective thunderstorms in summer. Snowfall is common in winter. The freeze-free period ranges from 192-199 days and the frost-free period ranges from 171-179 days.

Table 4. Representative climatic features

Frost-free period (characteristic range)	171-179 days
Freeze-free period (characteristic range)	192-199 days
Precipitation total (characteristic range)	1,118-1,194 mm
Frost-free period (actual range)	166-180 days
Freeze-free period (actual range)	190-204 days
Precipitation total (actual range)	1,016-1,219 mm
Frost-free period (average)	175 days
Freeze-free period (average)	196 days
Precipitation total (average)	1,143 mm

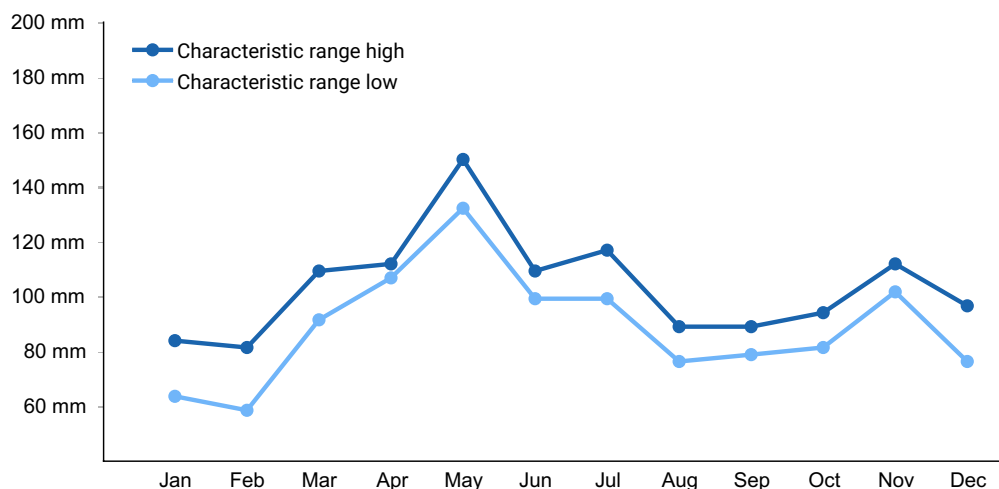

Figure 1. Monthly precipitation range

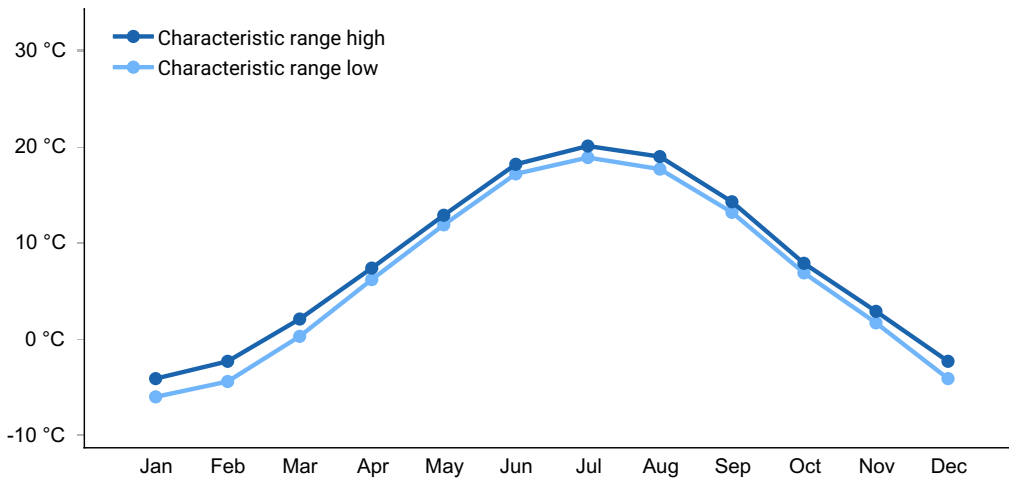

Figure 2. Monthly minimum temperature range

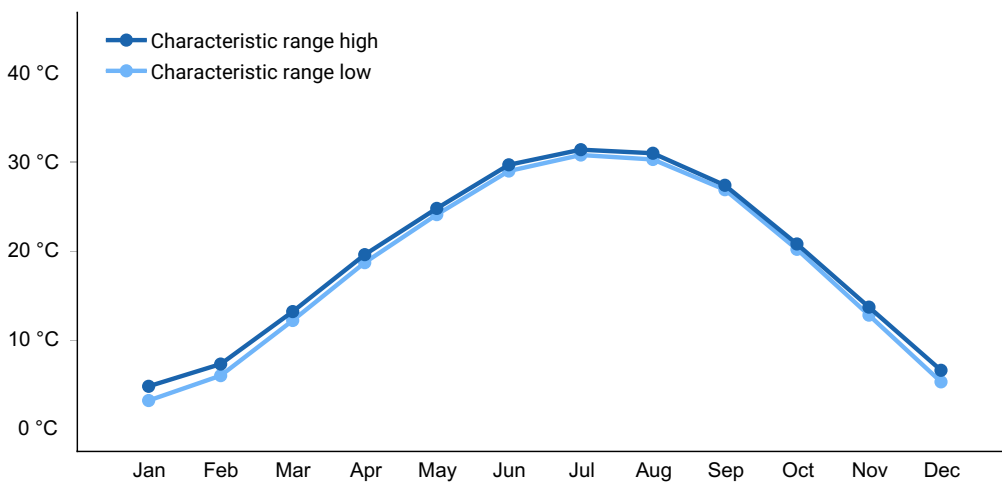

Figure 3. Monthly maximum temperature range

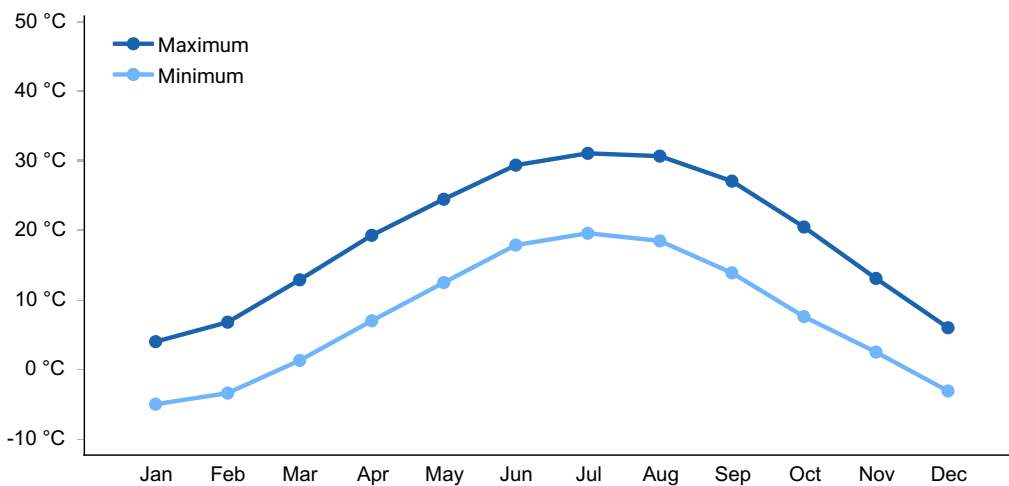

Figure 4. Monthly average minimum and maximum temperature

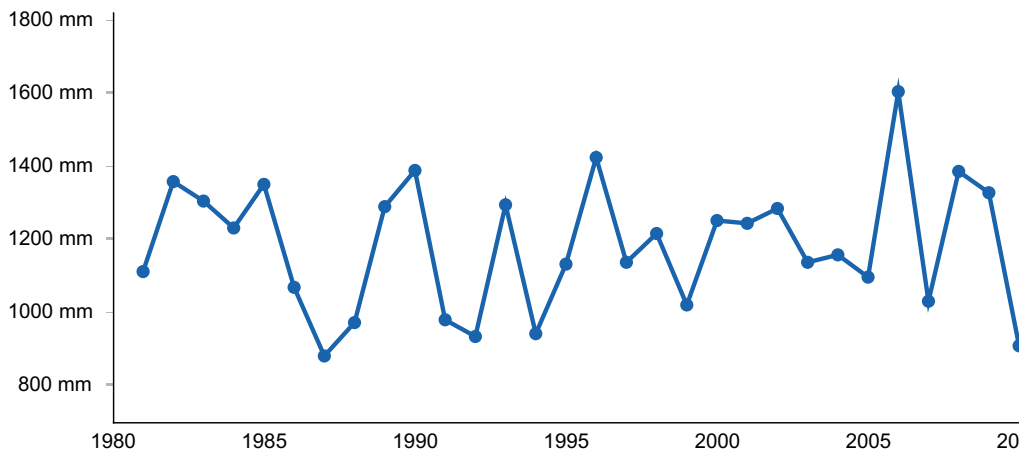

Figure 5. Annual precipitation pattern

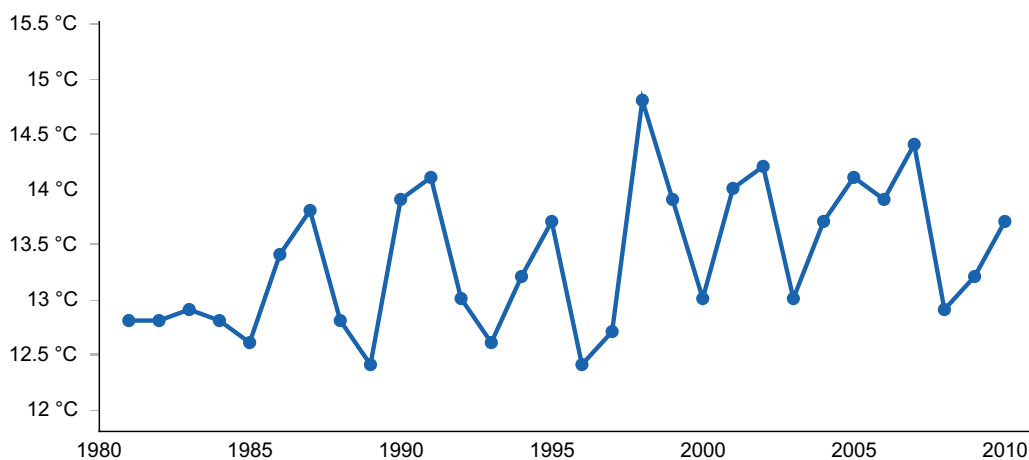

Figure 6. Annual average temperature pattern

Climate stations used

- (1) EVANSVILLE REGIONAL AP [USW00093817], Evansville, IN
- (2) PRINCETON 1 W [USC00127125], Princeton, IN
- (3) VINCENNES 5 NE [USC00129113], Vincennes, IN
- (4) TERRE HAUTE CAA AP [USW00093823], Terre Haute, IN
- (5) MT VERNON [USC00126001], Uniontown, IN

Influencing water features

Clayey Terrace Forest sites may rarely be influenced by riparian water features. Precipitation is the main source of water for vegetation. Sites may have a seasonal highwater table is present at a depth of 18" to greater than 72" below the surface (NASIS, 2020). These sites range in slope from 2-25% which will affect drainage and soil moisture retention. On sloping sites, surface runoff water occurs to downslope ecological sites.

Soil features

Clayey Terrace sites in LRU 115AX are on soils that are very deep, well drained and

moderately well drained, with very slow permeability. Depth to restriction within the soil profile can vary. Soil series associated with this site is Markland. Parent material kind and origin includes loess over clayey lacustrine deposits (NASIS, 2020)

Table 5. Representative soil features

Parent material	(1) Loess (2) Lacustrine deposits
Surface texture	(1) Silt loam (2) Silty clay loam
Drainage class	Moderately well drained to well drained
Permeability class	Very slow
Depth to restrictive layer	152–203 cm
Soil depth	152–203 cm
Surface fragment cover <=3"	0%
Surface fragment cover >3"	0%
Available water capacity (Depth not specified)	10.16–17.78 cm
Calcium carbonate equivalent (Depth not specified)	0–45%
Electrical conductivity (Depth not specified)	0–2 mmhos/cm
Sodium adsorption ratio (Depth not specified)	0
Soil reaction (1:1 water) (Depth not specified)	4.5–8.4
Subsurface fragment volume <=3" (Depth not specified)	0%
Subsurface fragment volume >3" (Depth not specified)	0%

Ecological dynamics

This ecological site is located on stream terraces and lake plains throughout LRU115XA. Sites either do not flood or rarely flood and ponding does not occur. The characteristic ecological community for this site is a mixed deciduous forest with a high level of canopy diversity. Sites will exhibit variations in species composition based on drainage, slope, and water table depth. Although only one soil series is represented in the group (Markland), the drainage and water table depths on these sites still vary and will be reflected in plant communities on site.

Multiple species of oaks were historically present on these sites, so fire was an influencing factor. Other natural impacts such as drought, floods, wind damage, and ice storms influenced these communities over centuries. Long-term periods of drought, especially if fire occurred, would have influenced the species composition, shrub density, plant mortality, and tree growth rates.

Many of the lower slope sites have now been converted to agriculture – either cropland or hayland production. Cleared sites on higher slopes are often grazed; however, management is limited by slope. Landowners should be aware of potential overgrazing impacts such as soil erosion, soil compaction, water quality impacts, and noxious weeds on these sites. Invasive non-native vegetation is a serious concern in many remaining wooded areas as bush honeysuckle, euonymus, Japanese honeysuckle, privet, and other non-native plants have been introduced and are increasing without management controls.

State and transition model

Ecosystem states

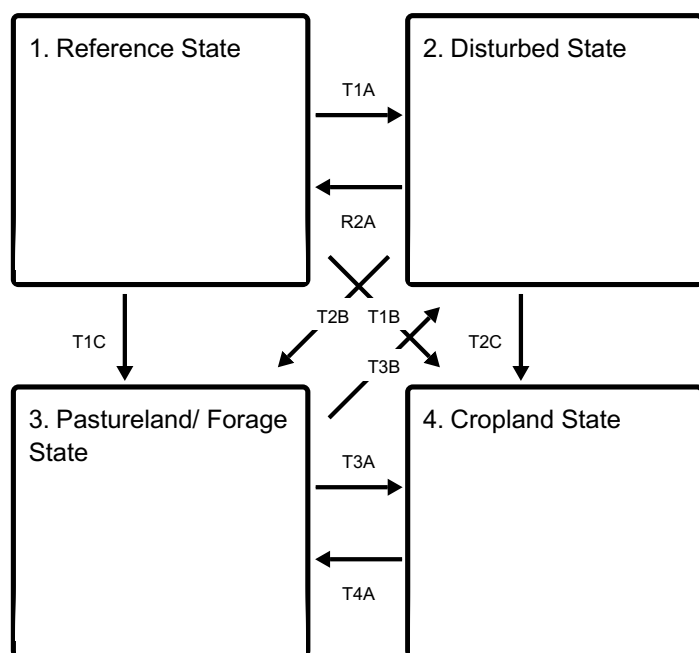

T1A - Large scale disturbance

T1C - Clearing of site; agricultural production - forage

T1B - Clearing of site; agricultural production - row crops.

R2A - Restoration inputs such as planting, brush control, prescribed fire, and timber stand improvement.

T2B - Clearing; agricultural production - forage

T2C - Clearing; agricultural production - row crops

T3B - Abandonment of agricultural practices

T3A - Site preparation and tillage, seeding, weed control, cropland management

T4A - Transition site to forage production; seeding; weed/brush control; pasture management

State 1 submodel, plant communities

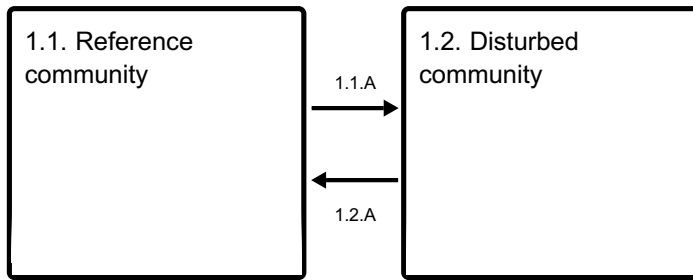

1.1.A - Fire suppression

1.2.A - Natural fire regime

State 2 submodel, plant communities

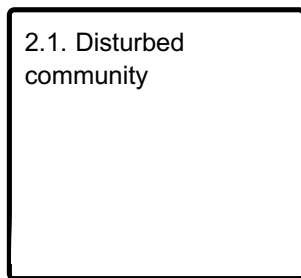

State 3 submodel, plant communities

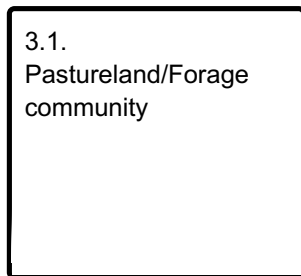

State 4 submodel, plant communities

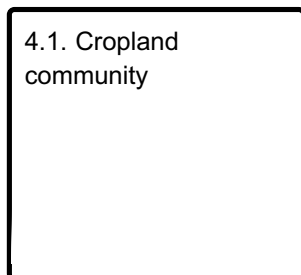

State 1 Reference State

Historically these sites were influenced by wildfires, wind damage, ice storms, and grazing by native species. The Clayey Terrace Reference State is characterized by a mature deciduous forest with a substantial oak component. Co-dominant species commonly included northern red oak, white ash, sugar maple, American elm, and hickory. Flat and convex sites with higher water tables may include pin oak, green ash, and red maple. The shrub layer varies on these sites but can include dogwood, possumhaw, and pawpaw.

Understory composition and density will be varied depending on drainage, depth of wet layer, flooding regime, aspect, and topography.

Dominant plant species

- northern red oak (*Quercus rubra*), tree
- bitternut hickory (*Carya cordiformis*), tree
- pawpaw (*Asimina triloba*), shrub
- dogwood (*Cornus*), shrub
- sedge (*Carex*), grass
- grape (*Vitis*), other herbaceous

Community 1.1

Reference community

These sites will exhibit a continuum of species depending on drainage and microtopography. There is often a landscape mosaic of slightly higher, wet-mesic raised areas, and wetter depressions. Accordingly, there is a continuum of variation in plant community composition. Historically, sites had a substantial oak component. Species include white oak, northern red oak, American elm, white ash, sugar maple, and hickory. Flat and convex sites with higher water tables may include pin oak, green ash, and red maple. The shrub layer varies on these sites but can include dogwood, possumhaw, and pawpaw.

Dominant plant species

- northern red oak (*Quercus rubra*), tree
- bitternut hickory (*Carya cordiformis*), tree
- pawpaw (*Asimina triloba*), shrub
- sedge (*Carex*), grass
- grape (*Vitis*), other herbaceous

Community 1.2

Disturbed community

This community exhibits an increase in fire in-tolerant tree species including maple and ash. Shrub density and tree sapling numbers will increase. Shade tolerant species in the understory will increase.

Dominant plant species

- maple (*Acer*), tree
- ash (*Fraxinus*), tree
- dogwood (*Cornus*), shrub
- maple (*Acer*), shrub
- pawpaw (*Asimina triloba*), shrub

Pathway 1.1.A

Community 1.1 to 1.2

Suppression of fire will result in an increase in fire intolerant tree species.

Pathway 1.2.A

Community 1.2 to 1.1

A return to the natural fire regime will encourage oak regeneration, reduce shrub density, and decrease fire intolerant trees.

State 2

Disturbed State

Many sites have been altered due to human disturbances. Some sites have also been grazed or had intermittent selective harvest (i.e. oak removal). Trees on site, will depending on the type, length and severity of disturbances. Sites that have had a long-term absence of fire will display the following characteristics: an increase in fire -intolerant species, decrease in oak regeneration, an increase in shrub density, an increase in leaf-litter buildup, and an increase in shade-tolerant understory species. Diversity of species may also be reduced, especially if there has been an introduction of non-native species such as bush honeysuckle (*Lonicera maackii*).

Dominant plant species

- sugar maple (*Acer saccharum*), tree
- red maple (*Acer rubrum*), tree
- ash (*Fraxinus*), tree

Community 2.1

Disturbed community

This is a disturbed, successional community that includes a variety of fast-growing trees such as maples and ashes. Other species may include maple, ash, sweetgum and poplar. Shrub and understory species will depend on the type, severity and length of disturbances, available seed sources, and management inputs, if present.

Dominant plant species

- red maple (*Acer rubrum*), tree
- silver maple (*Acer saccharinum*), tree
- sweetgum (*Liquidambar styraciflua*), tree

State 3

Pastureland/ Forage State

A portion of these sites have been converted to pastureland or forage production. Species selection will depend upon the objectives and goals of the landowner; however, commonly planted grasses include tall fescue (*Schedonorus arundinaceus*), brome (*Bromus* spp.), white clover (*Trifolium repens*) and red clover (*Trifolium pratense*). Species health and productivity are determined by the management and long-term overgrazing on some sites has caused soil erosion and compaction.

Dominant plant species

- tall fescue (*Schedonorus arundinaceus*), grass
- brome (*Bromus*), grass
- Kentucky bluegrass (*Poa pratensis*), grass
- white clover (*Trifolium repens*), other herbaceous
- red clover (*Trifolium pratense*), other herbaceous

Community 3.1

Pastureland/Forage community

These sites are managed for forage production and often include tall fescue (*Schedonorus arundinaceus*), brome (*Bromus* spp.), white clover (*Trifolium repens*) and red clover (*Trifolium pratense*). Selection of species will depend on the landowner's objectives.

Dominant plant species

- tall fescue (*Schedonorus arundinaceus*), grass
- brome (*Bromus*), grass
- Kentucky bluegrass (*Poa pratensis*), grass
- red clover (*Trifolium pratense*), other herbaceous
- white clover (*Trifolium repens*), other herbaceous

State 4

Cropland State

Hydrological modifications such as ditching and tiling are often used on these sites to increase crop production. Common crops include corn (*Zea mays*), soybeans (*Glycine max*), and occasionally winter wheat (*Triticum aestivum*). Some landowners choose to convert sites to cool season grasses for a period before resuming cropland production. A return to the historical Reference State from State 4 is unlikely, if not impossible.

Dominant plant species

- corn (*Zea mays*), other herbaceous
- soybean (*Glycine*), other herbaceous

Community 4.1

Cropland community

This community is characterized by the management and production of row crop agriculture. Common species include corn, soybean and wheat. Many other crops are suitable for these sites, and species selection will depend upon the landowners goals and objectives.

Dominant plant species

- soybean (*Glycine max*), other herbaceous
- corn (*Zea mays*), other herbaceous

Transition T1A

State 1 to 2

Severe disturbances, such as clearing or selective harvesting (oak/hickory removal) , will transition this site to State 2.

Transition T1C

State 1 to 3

Site is transitioned to an agricultural site focused on forage production. Management inputs would include clearing, site preparation, seeding and weed/brush control.

Transition T1B

State 1 to 4

Site is transitioned to an agricultural site focused on row crop production. Management inputs would include clearing, site preparation, seeding and weed control. Hydrological modifications are often installed to aid in drainage.

Restoration pathway R2A

State 2 to 1

Restoration would require long-term management inputs including planting of desired species, weed control, brush control, timber stand improvement, and prescribed fire.

Transition T2B

State 2 to 3

Site is cleared and forage/pasture production is initiated. Management inputs would include tree/shrub removal, site preparation, seeding, and weed/brush control.

Transition T2C

State 2 to 4

Site is cleared and row crop production is initiated. Management inputs would include tree/shrub removal, site preparation, tillage, seeding, and weed control.

Transition T3B

State 3 to 2

Site is abandoned and slowly would transition to a wooded state dominated by deciduous trees. Species on site would depend on the severity and length of disturbance and available seed sources.

Transition T3A

State 3 to 4

Management inputs that transition a site from pasture or forage production to a site that is utilized for row crop production.

Transition T4A

State 4 to 3

Management inputs to transition a site from cropland production to a state of pasture/forage production.

Additional community tables

Inventory data references

A Provisional Ecological Site Description (PESD) describes ecological potential and ecosystem dynamics of land areas and their potential management. Ecological sites are linked to soil survey map unit components, which allows for mapping of ecological sites. A PESD with a provisional status represents the lowest tier of documentation that is releasable to the public. No field level data have been collected as part of this PESD. It is expected that a PESD will continue to be refined through field verification and field sampling.

Reference and alternative state concepts, including the state-and-transition model and vegetative communities are not yet well-documented and will require field sampling for verification.

This document is provisional.

Other references

Brinson, M. M. 1993. A hydrogeomorphic classification for wetlands. Technical Report WRP-DE-4, U.S. Army Corps of Engineers, Engineer Waterways Experiment Station, Vicksburg, MS.

Braun, E. Lucy. 2001. Deciduous forests of eastern North America. Caldwell, N.J.: Blackburn Press.

Cleland, D. T., J. A. Freeouf, J. E. Keys, G. J. Nowacki, C. Carpenter, and W. H. McNab. 2007. Ecological Subregions: Sections and Subsections of the Conterminous United States. USDA Forest Service, General Technical Report WO-76. Washington, DC. 92 pp.

Comer P. J., Faber-Langendoen D, Evans R, Gawler S. C, Josse C, Kittel G, Menard S, Pyne M, Reid M, Schulz K, Snow K, and Teague J. 2003. Ecological Systems of the United States: A Working Classification of U.S. Terrestrial Systems. NatureServe, Arlington, Virginia.

Cowardin, L.M., V. Carter, F. C. Golet, and E.T. LaRoe. 1979. Classification of wetlands and deep water habitats of the United States. U.S. Dept. of Interior, Fish & Wildlife Service, Office of Biological Services, Washington DC. FWS/OBS-79/31. 142 pp.

Homoya, M. A., Abrell, D. B., Aldrich, J. R., & Post, T. W. (1985). The Natural Regions of Indiana. Indiana Academy of Science, 94, 245-269

Jackson, Marion T. 1997. The Natural heritage of Indiana. Bloomington: Indiana University Press, published in association with the Indiana Department of Natural Resources and the Indiana Academy of Science.

LANDFIRE (Landfire National Vegetation Dynamics Database). 2009. Landfire National Vegetation Dynamics Models. Landfire Project, USDA Forest Service, U.S. Department of Interior. (<http://www.LANDFIRE.gov/index.php>: accessed 2020).

Mohlenbrock, R. H. and D. M. Ladd. 1978. Distribution of Illinois Vascular Plants. Southern Illinois Univ. Press, Carbondale and Edwardsville, Ill. 282 pp.

Mohlenbrock, R. H. 2003. Vascular Flora of Illinois, 3rd edition. Carbondale, Illinois: Southern Illinois University Press. 736 pp.

National Cooperative Soil Survey (NCSS). National Cooperative Soil Characterization Database. Available online: <https://ncsslabsdatamart.sc.egov.usda.gov/>. Accessed: 2020.

NatureServe. 2018. NatureServe Explorer: An online encyclopedia of life [web application]. Version 7.1. NatureServe, Arlington, Virginia. Available <http://explorer.natureserve.org>. (Association Detail Report: CEGL002427) (Accessed: 2020)

Soil Survey Staff, Natural Resources Conservation Service, United States Department of Agriculture. Web Soil Survey (SSS NRCS WSS). Available online at the following link: <https://websoilsurvey.sc.egov.usda.gov/>. Accessed 2020.

Soil Survey Staff, Natural Resources Conservation Service, United States Department of Agriculture. Official Soil Series Descriptions (SSS NRCS OSD). Available online. Accessed 2020. <https://soilseries.sc.egov.usda.gov/osdname.aspx>

United States Department of Agriculture, Natural Resources Conservation Service (USDA – NRCS). 2006. Land resource regions and major land resource areas of the United States, the Caribbean, and the Pacific Basin. USDA Handbook 296. 682 pp.

United States Department of Agriculture, Natural Resources Conservation Service. 2022. Land resource regions and major land resource areas of the United States, the Caribbean, and the Pacific Basin. U.S. Department of Agriculture, Agriculture Handbook 296.

USDA, NRCS. 2018. The PLANTS Database (<http://plants.usda.gov>, 1 March 2018). National Plant Data Team, Greensboro, NC 27401-4901 USA.

Voigt, J. W., and R. H. Mohlenbrock. 1964. Plant communities of southern Illinois. Southern Illinois University Press, Carbondale. 202 pp.

Whitaker, John O., Charles J. Amlaner, Marion T. Jackson, George R. Parker, and Peter Evans Scott. 2012. Habitats and ecological communities of Indiana presettlement to present. Bloomington: Indiana University Press.

Contributors

Anita Arends, Ecological Site Specialist, USDA-NRCS, Illinois
Ralph Tucker, Soil Survey Office Leader, USDA-NRCS, Missouri
Dena Anderson, Resource Soil Scientist, USDA-NRCS, Indiana
Zack Weber, Soil Scientist, USDA-NRCS, Illinois

Rangeland health reference sheet

Interpreting Indicators of Rangeland Health is a qualitative assessment protocol used to determine ecosystem condition based on benchmark characteristics described in the Reference Sheet. A suite of 17 (or more) indicators are typically considered in an assessment. The ecological site(s) representative of an assessment location must be known prior to applying the protocol and must be verified based on soils and climate. Current plant community cannot be used to identify the ecological site.

Author(s)/participant(s)	
Contact for lead author	
Date	04/09/2026

Approved by	Suzanne Mayne-Kinney
Approval date	
Composition (Indicators 10 and 12) based on	Annual Production

Indicators

1. Number and extent of rills:

2. Presence of water flow patterns:

3. Number and height of erosional pedestals or terracettes:

4. Bare ground from Ecological Site Description or other studies (rock, litter, lichen, moss, plant canopy are not bare ground):

5. Number of gullies and erosion associated with gullies:

6. Extent of wind scoured, blowouts and/or depositional areas:

7. Amount of litter movement (describe size and distance expected to travel):

8. Soil surface (top few mm) resistance to erosion (stability values are averages - most sites will show a range of values):

9. Soil surface structure and SOM content (include type of structure and A-horizon color and thickness):

10. **Effect of community phase composition (relative proportion of different functional groups) and spatial distribution on infiltration and runoff:**
-

11. **Presence and thickness of compaction layer (usually none; describe soil profile features which may be mistaken for compaction on this site):**
-

12. **Functional/Structural Groups (list in order of descending dominance by above-ground annual-production or live foliar cover using symbols: >>, >, = to indicate much greater than, greater than, and equal to):**

Dominant:

Sub-dominant:

Other:

Additional:

13. **Amount of plant mortality and decadence (include which functional groups are expected to show mortality or decadence):**
-

14. **Average percent litter cover (%) and depth (in):**
-

15. **Expected annual annual-production (this is TOTAL above-ground annual-production, not just forage annual-production):**
-

16. **Potential invasive (including noxious) species (native and non-native). List species which BOTH characterize degraded states and have the potential to become a dominant or co-dominant species on the ecological site if their future establishment and growth is not actively controlled by management interventions. Species that become dominant for only one to several years (e.g., short-term response to drought or wildfire) are not invasive plants. Note that unlike other indicators, we are describing what is NOT expected in the reference state for the ecological site:**

17. **Perennial plant reproductive capability:**
